

## DH Backlighting LED in Ø 3 mm Tinted Non-Diffused Package

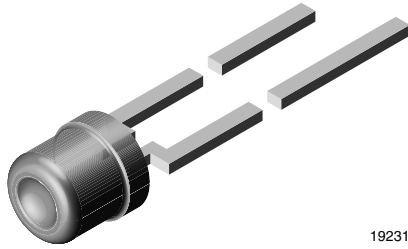

### DESCRIPTION

The TLVD42.... series was developed for backlighting in the extrem bright double heterojunction (DH) red GaAlAs on GaAs technology. Due to its special shape the spatial distribution of the radiation is qualified for backlighting.

To optimize the brightness of backlighting a custom-built reflector (with scattering) is required. Uniform illumination can be enhanced by covering the front of the reflector with diffusor material.

This is a bright and flexible solution for backlighting different areas.

### PRODUCT GROUP AND PACKAGE DATA

- Product group: LED
- Package: 3 mm backlighting
- Product series: standard
- Angle of half intensity:  $\pm 85^\circ$

### FEATURES

- High brightness
- Wide viewing angle
- Categorized for luminous flux
- Available in DH red
- Tinted clear package
- Low power dissipation
- Low self heating
- Rugged design
- High reliability
- Material categorization: for definitions of compliance please see [www.vishay.com/doc?99912](http://www.vishay.com/doc?99912)



### APPLICATIONS

- Backlighting of display panels, LCD displays, symbols on switches, keyboards, graphic boards, and measuring scales
- Illumination of large areas e.g. dot matrix displays

### PARTS TABLE

PART	COLOR	LUMINOUS FLUX (mlm)			at I <sub>F</sub> (mA)	WAVELENGTH (nm)			at I <sub>F</sub> (mA)	FORWARD VOLTAGE (V)			at I <sub>F</sub> (mA)	TECHNOLOGY
		MIN.	TYP.	MAX.		MIN.	TYP.	MAX.		MIN.	TYP.	MAX.		
TLVD42Q1S2	Red	71	80	280	15	630	640	650	10	-	1.8	2.2	20	GaAlAs on GaAs
TLVD42R1S2	Red	112	130	280	15	630	640	650	10	-	1.8	2.2	20	GaAlAs on GaAs

### ABSOLUTE MAXIMUM RATINGS (T<sub>amb</sub> = 25 °C, unless otherwise specified)

#### TLVD42....

PARAMETER	TEST CONDITION	SYMBOL	VALUE	UNIT
Reverse voltage		V <sub>R</sub>	6	V
DC forward current		I <sub>F</sub>	50	mA
Surge forward current	t <sub>p</sub> ≤ 10 μs	I <sub>FSM</sub>	1	A
Power dissipation	T <sub>amb</sub> ≤ 60 °C	P <sub>V</sub>	100	mW
Junction temperature		T <sub>j</sub>	100	°C
Operating temperature range		T <sub>amb</sub>	-40 to +100	°C
Storage temperature range		T <sub>stg</sub>	-55 to +100	°C
Soldering temperature	t ≤ 5 s, 2 mm from body	T <sub>sd</sub>	260	°C
Thermal resistance junction/ambient		R <sub>thJA</sub>	400	K/W



OPTICAL AND ELECTRICAL CHARACTERISTICS ( $T_{amb} = 25\text{ }^{\circ}\text{C}$ , unless otherwise specified)							
TLVD42...., RED							
PARAMETER	TEST CONDITION	PART	SYMBOL	MIN.	TYP.	MAX.	UNIT
Luminous flux	$I_F = 15\text{ mA}$	TLVD42Q1S2	$\phi_V$	71	80	280	mIm
		TLVD42R1S2	$\phi_V$	112	130	280	mIm
Dominant wavelength	$I_F = 10\text{ mA}$	$\lambda_d$	$\lambda_d$	630	640	650	nm
Peak wavelength	$I_F = 10\text{ mA}$	$\lambda_p$	$\lambda_p$	-	650	-	nm
Angle of half intensity	$I_F = 10\text{ mA}$	$\phi$	$\phi$	-	$\pm 85$	-	deg
Forward voltage	$I_F = 20\text{ mA}$	$V_F$	$V_F$	-	1.8	2.2	V
Reverse voltage	$I_R = 10\text{ }\mu\text{A}$	$V_R$	$V_R$	6	15	-	V
Junction capacitance	$V_R = 0\text{ V}$ , $f = 1\text{ MHz}$	$C_j$	$C_j$	-	50	-	pF

LUMINOUS FLUX CLASSIFICATION				
GROUP	LUMINOUS FLUX (mIm)			
	STANDARD	OPTIONAL	MIN.	MAX.
Q		1	71	90
		2	90	112
R		1	112	140
		2	140	180
S		1	180	224
		2	224	280

**Note**

- Luminous flux is tested at a current pulse duration of 25 ms and an accuracy of  $\pm 11\%$ .  
The above type numbers represent the order groups which include only a few brightness groups. Only one group will be shipped on each bag (there will be no mixing of two groups in each bag).  
In order to ensure availability, single brightness groups will not be orderable.  
In a similar manner for colors where wavelength groups are measured and binned, single wavelength groups will be shipped on any one bag.  
In order to ensure availability, single wavelength groups will not be orderable.

**TYPICAL CHARACTERISTICS** ( $T_{amb} = 25\text{ }^{\circ}\text{C}$ , unless otherwise specified)

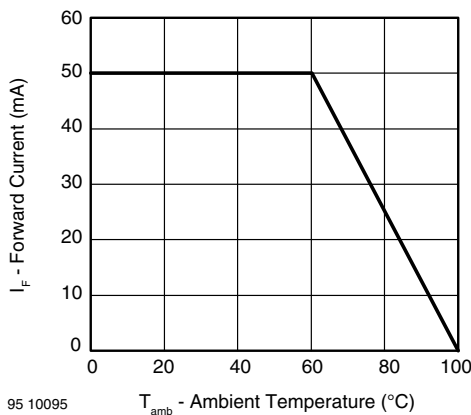

Fig. 1 - Forward Current vs. Ambient Temperature

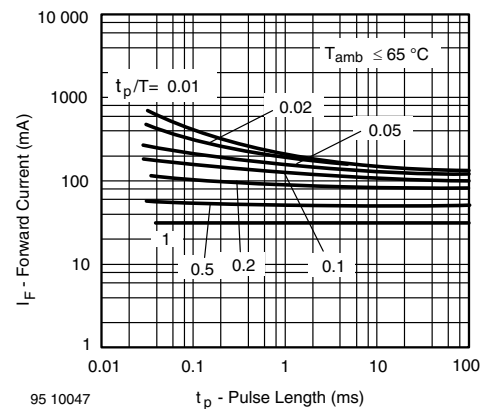

Fig. 2 - Forward Current vs. Pulse Length

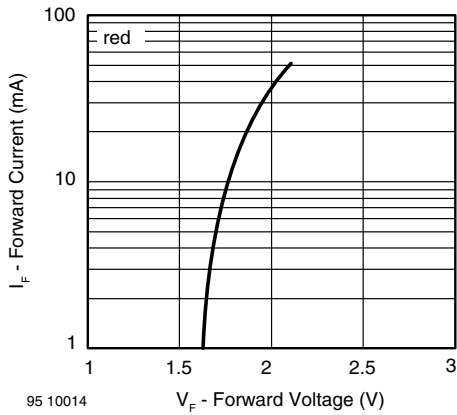

Fig. 3 - Forward Current vs. Forward Voltage

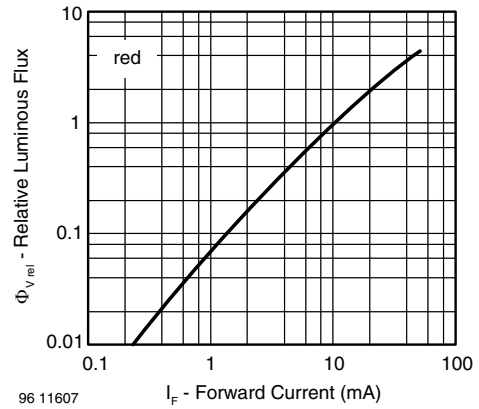

Fig. 6 - Relative Luminous Flux vs. Forward Current

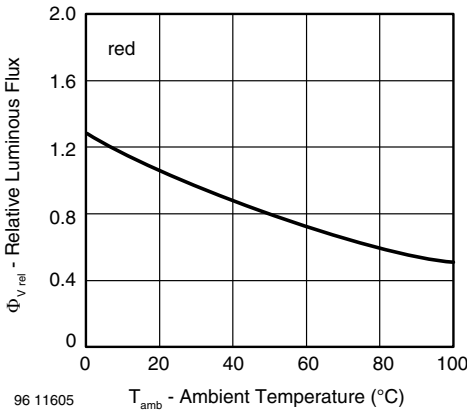

Fig. 4 - Relative Luminous Flux vs. Ambient Temperature

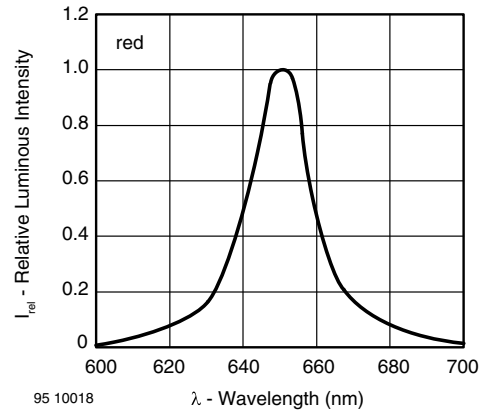

Fig. 7 - Relative Intensity vs. Wavelength

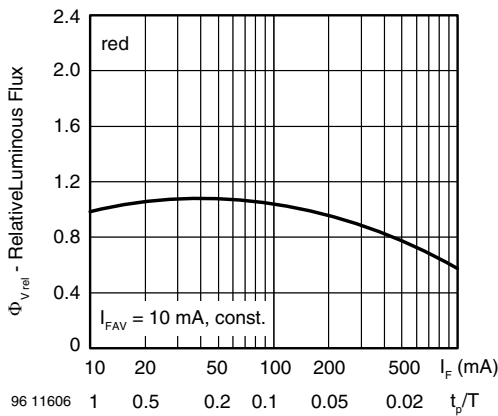

Fig. 5 - Relative Luminous Flux vs. Forward Current/Duty Cycle

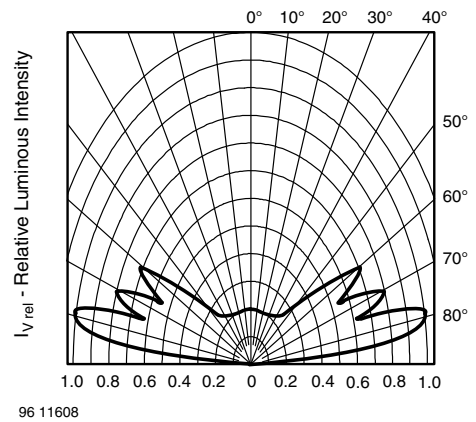
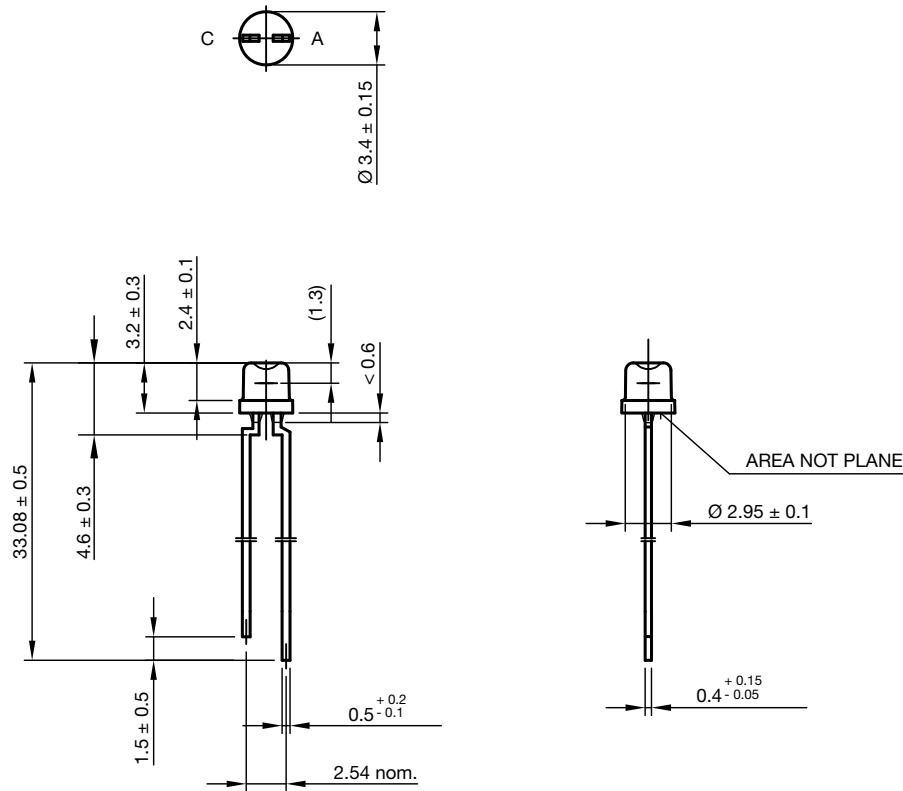

Fig. 8 - Relative Luminous Intensity vs. Angular Displacement for 90° Emission Angle

**PACKAGE DIMENSIONS** in millimeters



technical drawings according to DIN specifications

Drawing-No.: 6.544-5226.01-4  
Issue: 2; 28.07.14



## **Disclaimer**

ALL PRODUCT, PRODUCT SPECIFICATIONS AND DATA ARE SUBJECT TO CHANGE WITHOUT NOTICE TO IMPROVE RELIABILITY, FUNCTION OR DESIGN OR OTHERWISE.

Vishay Intertechnology, Inc., its affiliates, agents, and employees, and all persons acting on its or their behalf (collectively, "Vishay"), disclaim any and all liability for any errors, inaccuracies or incompleteness contained in any datasheet or in any other disclosure relating to any product.

Vishay makes no warranty, representation or guarantee regarding the suitability of the products for any particular purpose or the continuing production of any product. To the maximum extent permitted by applicable law, Vishay disclaims (i) any and all liability arising out of the application or use of any product, (ii) any and all liability, including without limitation special, consequential or incidental damages, and (iii) any and all implied warranties, including warranties of fitness for particular purpose, non-infringement and merchantability.

Statements regarding the suitability of products for certain types of applications are based on Vishay's knowledge of typical requirements that are often placed on Vishay products in generic applications. Such statements are not binding statements about the suitability of products for a particular application. It is the customer's responsibility to validate that a particular product with the properties described in the product specification is suitable for use in a particular application. Parameters provided in datasheets and / or specifications may vary in different applications and performance may vary over time. All operating parameters, including typical parameters, must be validated for each customer application by the customer's technical experts. Product specifications do not expand or otherwise modify Vishay's terms and conditions of purchase, including but not limited to the warranty expressed therein.

Except as expressly indicated in writing, Vishay products are not designed for use in medical, life-saving, or life-sustaining applications or for any other application in which the failure of the Vishay product could result in personal injury or death. Customers using or selling Vishay products not expressly indicated for use in such applications do so at their own risk. Please contact authorized Vishay personnel to obtain written terms and conditions regarding products designed for such applications.

No license, express or implied, by estoppel or otherwise, to any intellectual property rights is granted by this document or by any conduct of Vishay. Product names and markings noted herein may be trademarks of their respective owners.