

FLORENTINA-4X1-W

~40° wide beam

TECHNICAL SPECIFICATIONS:

Dimensions	169.7 x 49.7 mm
Height	29.7 mm
Fastening	pin
Colour	black
Box size	476 x 273 x 292 mm
Box weight	3.2 kg
Quantity in Box	72 pcs
ROHS compliant	yes ⓘ



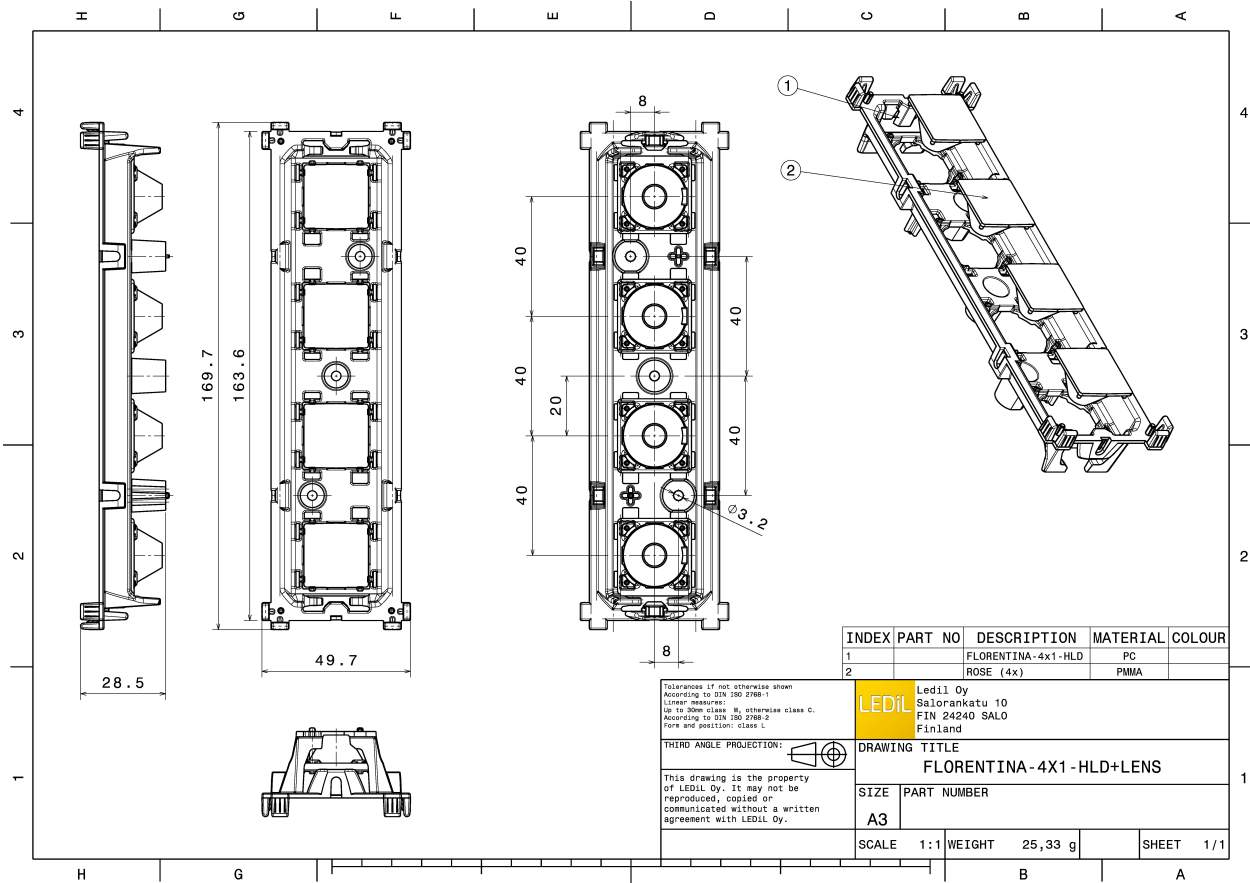

MATERIAL SPECIFICATIONS:

Component	Type	Material	Colour
ROSE-C-C-W-V4	Single lens	PC	clear
FLORENTINA-4X1-HLD	Holder	PC	black

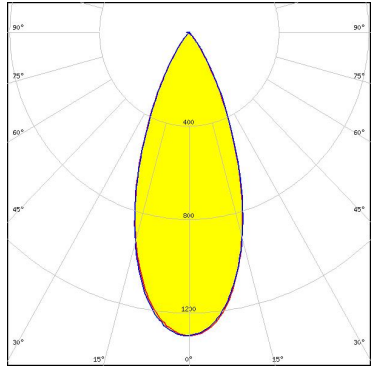

PHOTOMETRIC DATA (MEASURED):

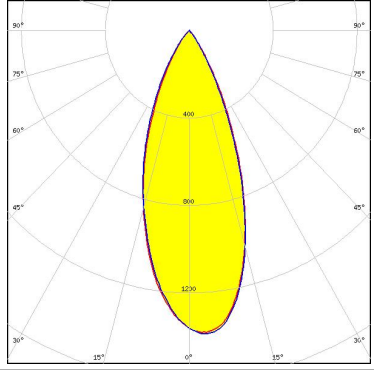
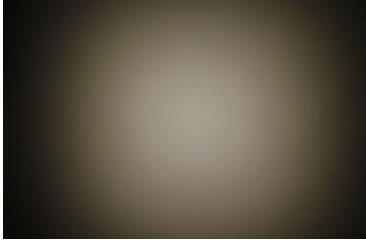
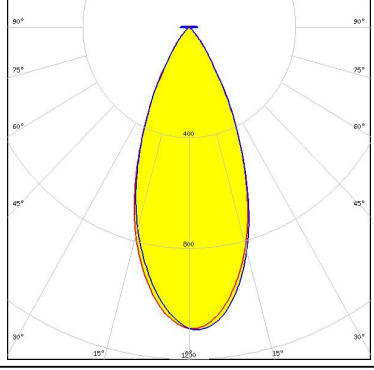
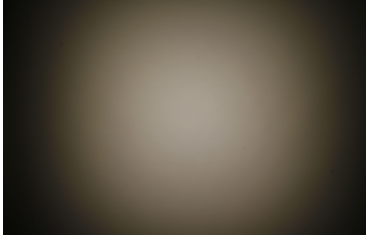
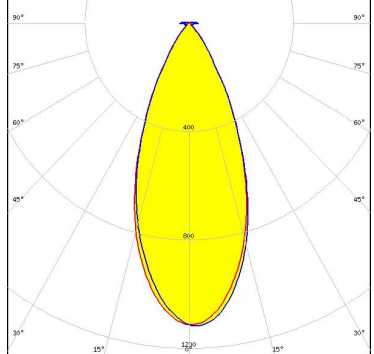
<p>COMET ELECTRONICS</p> <p>LED EASY-T FLUX 1x4 FLR XG xxx G7 FWHM 41.0° Efficiency 67 % Peak intensity 1.300 cd/lm LEDs/each optic 1 Light colour White Required components: C15028_FLORENTINA-4X1-SHD</p>		
<p>COMET ELECTRONICS</p> <p>LED EASY-T FLUX 1x4 FLR XT xxx G5 FWHM 39.0° Efficiency 68 % Peak intensity 1.400 cd/lm LEDs/each optic 1 Light colour White Required components: C15028_FLORENTINA-4X1-SHD</p>		
<p>CREE</p> <p>LED XP-L2 FWHM 43.0° Efficiency 69 % Peak intensity 1.100 cd/lm LEDs/each optic 1 Light colour White Required components: C15028_FLORENTINA-4X1-SHD</p>		
<p>CREE</p> <p>LED XP-L2 FWHM 43.0° Efficiency 72 % Peak intensity 1.100 cd/lm LEDs/each optic 1 Light colour White Required components: C15690_FLORENTINA-4X1-SHD-WHT</p>		

PHOTOMETRIC DATA (MEASURED):



LED XP-L2
 FWHM 43.0°
 Efficiency 69 %
 Peak intensity 1.100 cd/lm
 LEDs/each optic 1
 Light colour White
 Required components:
 C15318_FLORENCE-3R-IP-CLIP

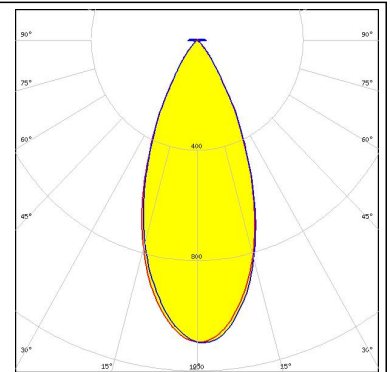
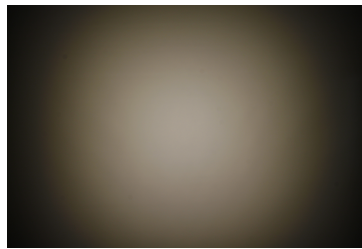

LED NVSxx19B/NVSxx19C
 FWHM 39.0°
 Efficiency 72 %
 Peak intensity 1.400 cd/lm
 LEDs/each optic 1
 Light colour White
 Required components:
 C15198_FLORENTINA-4X1-SHD-OPEN

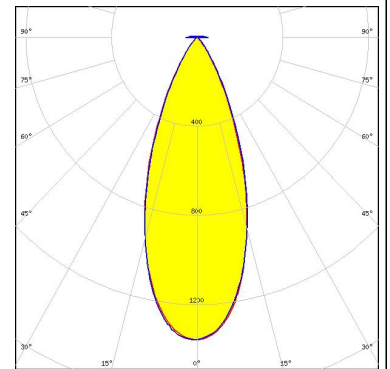
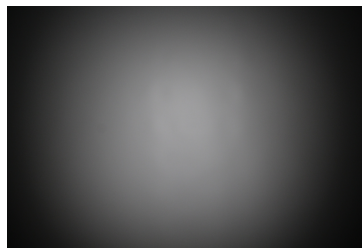

LED NVSxx19B/NVSxx19C
 FWHM 39.0°
 Efficiency 72 %
 Peak intensity 1.400 cd/lm
 LEDs/each optic 1
 Light colour White
 Required components:
 C15028_FLORENTINA-4X1-SHD

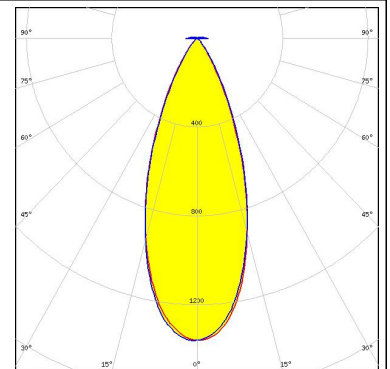
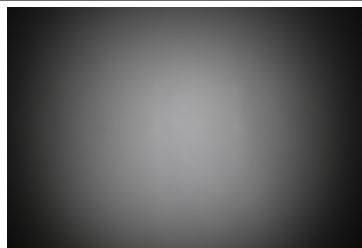

LED Oslon Square Gen3
 FWHM 36.0°
 Efficiency 69 %
 Peak intensity 1.500 cd/lm
 LEDs/each optic 1
 Light colour White
 Required components:
 C15028_FLORENTINA-4X1-SHD

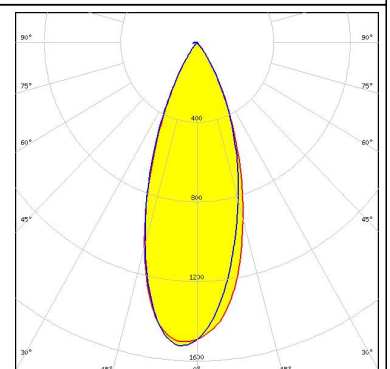
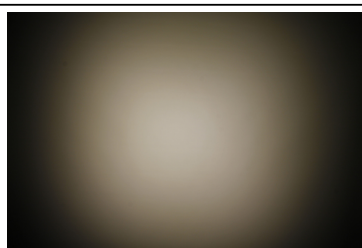

PHOTOMETRIC DATA (MEASURED):

OSRAM
Opto Semiconductors

LED Oslon Square Gen3
FWHM 39.0°
Efficiency 70 %
Peak intensity 1.500 cd/lm
LEDs/each optic 1
Light colour White
Required components:
C15198_FLORENTINA-4X1-SHD-OPEN

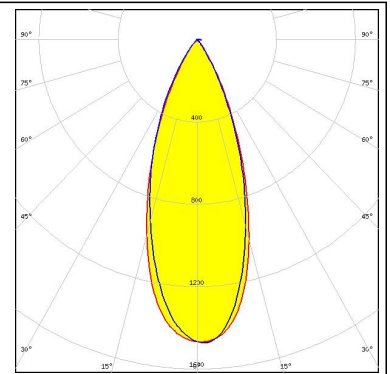
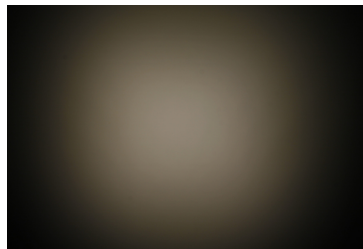

PHOTOMETRIC DATA (SIMULATED):



LED XP-L HD
FWHM 47.0°
Efficiency 70 %
Peak intensity 1.040 cd/lm
LEDs/each optic 1
Light colour White
Required components:
C15028_FLORENTINA-4X1-SHD

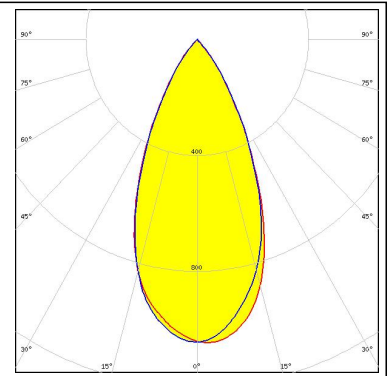

GENERAL INFORMATION:

NOTE: The typical beam angle will be changed by different color, chip size and chip position tolerance. The typical total beam angle is the full angle measured where the luminous intensity is half of the peak value.

MATERIALS:

As part of our continuous research and improvement processes, and to ensure the best possible quality and availability of our products, LEDiL reserves the right to change material grades without notice.

PRODUCT DATA USER AGREEMENT AND DISCLAIMER:

The measured data in the provided downloadable LEDiL Product Datasheets and Mechanical 2D-Drawings is rounded and provided as reference for planning. LEDiL Oy's optical specifications have been verified by conducting performance testing of the products in accordance with the company's quality system. The reported data are averaged results of multiple measurements with typical variation. LEDiL Oy reserves the right to without prior notification make changes and improvements to its products.

LEDiL Oy assumes neither warranty, nor guarantee nor any other liability of any kind for the contents and correctness of the provided data. The provided data has been generated with highest diligence but the provided data may in reality not represent the complete possible variation range of all intrinsic parameters. Therefore, in certain cases a deviation from the provided data could occur.

LEDiL Oy reserves the right to undertake technical changes of its products without further notification which could lead to changes in the provided data. LEDiL Oy assumes no liability of any kind for the possible deviation from any provided data or any other damage resulting from the usage of the provided data.

The user agrees to this disclaimer and user agreement with the download or usage of the provided files.

LEDiL Oy

Joensuunkatu 13
FI-24240 SALO
Finland

LEDiL Inc.

228 West Page Street
Suite D
Sycamore IL 60178
USA

Local sales and technical support

[www.ledil.com/
where_to_buy](http://www.ledil.com/where_to_buy)

Shipping locations

Salo, Finland
Hong Kong, China

Distribution Partners

[www.ledil.com/
where_to_buy](http://www.ledil.com/where_to_buy)