



EC7AW Series Application Note V10

ISOLATED DC-DC CONVERTER EC7AW SERIES APPLICATION NOTE



Approved By:

Department	Approved By	Checked By	Written By
Research and Development Department	Enoch	Danny	Johnny
		Jacky	
Quality Assurance Department	Ryan	Benny	



EC7AW Series Application Note V10

Contents

1. Introduction	3
2. Pin Function Description	3
3. Connection for Standard Use	4
4. Test Set-Up	4
5. Recommend Layout, PCB Footprint and Soldering Information	4
6. Features and Functions	5
6.1 UVLO (Under Voltage Lock Out)	5
6.2 Over Current/Short Circuit Protection	5
6.3 Output Over Voltage Protection	6
6.4 Remote On/Off	6
7. Input / Output Considerations	6
7.1 Input Capacitance at the Power Module	6
7.2 Output Ripple and Noise	7
7.3 Output Capacitance	7
8. Thermal Design	8
8.1 Operating Temperature Range	8
8.2 Convection Requirements for Cooling	8
8.3 Thermal Considerations	8
8.4 Power Derating	8
9. Safety & EMC	9
9.1 Input Fusing and Safety Considerations	9
9.2 EMC Considerations	9



EC7AW Series Application Note V10

1. Introduction

The EC7AW series of DC-DC converters offers 10 watts of output power @ output voltages of 3.3V, 5, 12, 15, ± 12 , ± 15 VDC with industry 1.25"x0.8"x0.4" package. It has a wide (4:1) input voltage range of 9 to 36VDC (24VDC nominal), 18 to 74VDC (48VDC nominal) and 3000VDC isolation.

High efficiency up to 89%, allowing case operating temperature range of -40°C to 85°C . Very low no load power consumption (7mA), an ideal solution for energy critical systems.

Fully protected against input UVLO (under voltage lock out), output over-current, output over-voltage and continuous short circuit conditions.

The standard control functions include remote on/off (positive or negative).

2. Pin Function Description

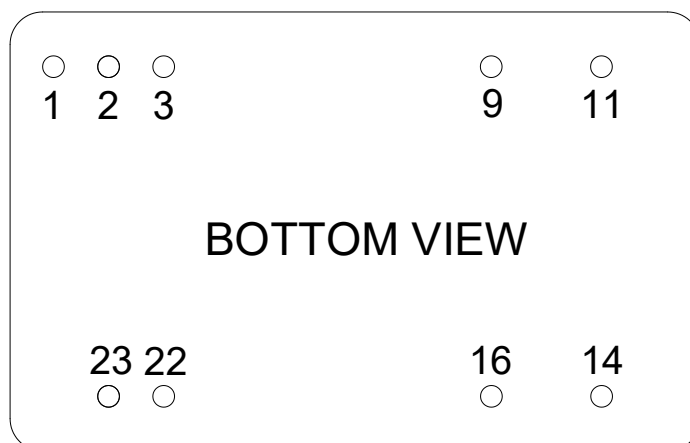

Single Output

No	Label	Function	Description	Reference
22 & 23	+IN	+V Input	Positive Supply Input	Section 7.1
2 & 3	-IN	-V Input	Negative Supply Input	Section 7.1
14	+OUT	+V Output	Positive Power Output	Section 7.2/7.3
16	-OUT	-V Output	Negative Power Output	Section 7.2/7.3
1	R	Remote On/Off	External Remote On/Off Control	Section 6.4
9	--	NP	No Pin	--
11	--	NC	No Connection with Pin	--

Dual Output

No	Label	Function	Description	Reference
22 & 23	+IN	+V Input	Positive Supply Input	Section 7.1
2 & 3	-IN	-V Input	Negative Supply Input	Section 7.1
14	+V1	+V Output	Positive Power Output	Section 7.2/7.3
11	-V2	-V Output	Negative Power Output	Section 7.2/7.3
9 & 16	-V1, +V2	Common	Common Power Output	Section 7.2/7.3
1	R	Remote On/Off	External Remote On/Off Control	Section 6.4



EC7AW Series Application Note V10

3. Connection for Standard Use

The connection for standard use is shown below. External output capacitors (C1, C2) are recommended to reduce output ripple and noise, 1uF ceramic capacitor for all models.

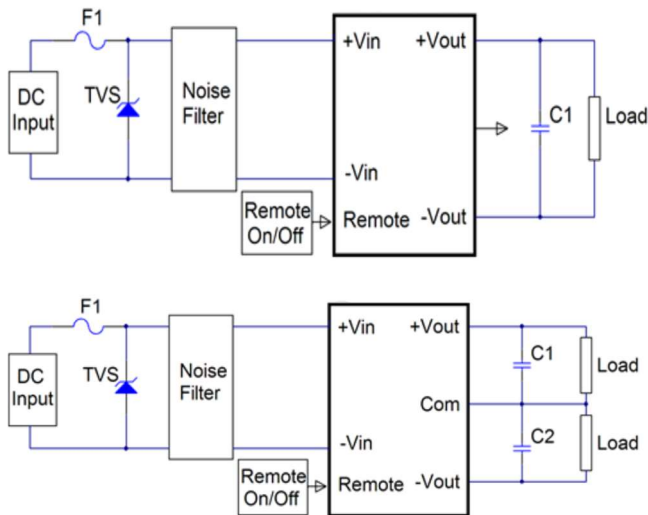

Symbol	Component	Reference
F1, TVS	Input fuse, TVS	Section 9.1
C1, C2	External capacitor on the output side	Section 7.3
Noise Filter	External input noise filter	Section 9.2
Remote On/Off	External remote on/off control	Section 6.4

4. Test Set-Up

The basic test set-up to measure parameters such as efficiency and load regulation is shown below. When testing the modules under any transient conditions please ensure that the transient response of the source is sufficient to power the equipment under test. We can calculate:

- Efficiency
- Load regulation and line regulation

The value of efficiency is defined as:

$$\eta = \frac{V_o \times I_o}{V_{in} \times I_{in}} \times 100\%$$

Where:

- V_o is output voltage
- I_o is output current
- V_{in} is input voltage
- I_{in} is input current

The value of load regulation is defined as:

$$Load\ reg. = \frac{V_{FL} - V_{NL}}{V_{NL}} \times 100\%$$

Where:

- V_{FL} is the output voltage at full load
- V_{NL} is the output voltage at no load

The value of line regulation is defined as:

$$Line\ reg. = \frac{V_{HL} - V_{LL}}{V_{LL}} \times 100\%$$

Where:

- V_{HL} is the output voltage of maximum input voltage at full load
- V_{LL} is the output voltage of minimum input voltage at full load

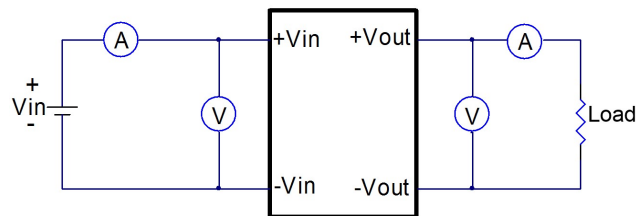

EC7AW Series Test Setup

5. Recommend Layout, PCB Footprint and Soldering Information

The system designer or end user must ensure that metal and other components in the vicinity of the converter meet the spacing requirements for which the system is approved. Low resistance and inductance PCB layout traces are the norm and should be used where possible. Due consideration must also be given to proper low impedance tracks between power module, input and output grounds. The recommended footprints and soldering profiles are shown below.



EC7AW Series Application Note V10

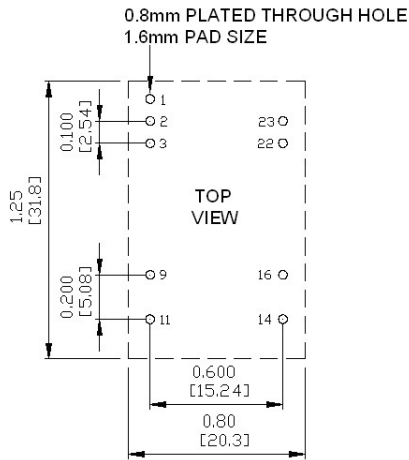

Note: Dimensions are in inches (millimeters)

Clean the soldered side of the module with a brush, prevent liquid from getting into the module. Do not clean by soaking the module into liquid. Do not allow solvent to come in contact with product labels or resin case as this may change the color of the resin case or cause deletion of the letters printed on the product label. After cleaning, dry the modules well.

The suggested soldering iron is $420 \pm 10^\circ\text{C}$ for up to 4-10 seconds (less than 90W) used in double PCB and multilayer PCB, The other one is used in the single PCB is $385 \pm 10^\circ\text{C}$ for up to 2-6 seconds (less than 90W). Furthermore the recommended soldering profile is shown below.

Lead Free Wave Soldering Profile

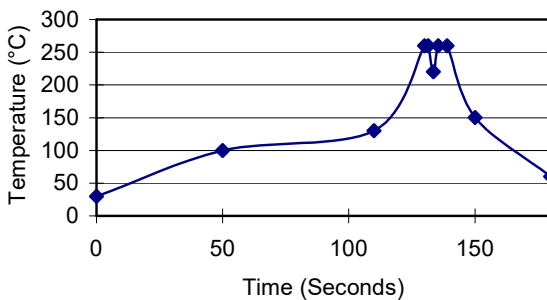

6. Features and Functions

6.1 UVLO (Under Voltage Lock Out)

Input under voltage lockout is standard on the EC7AW series unit. The unit will shut down when the input voltage drops below a lower threshold, and the unit will operate when the input voltage goes above the upper threshold.

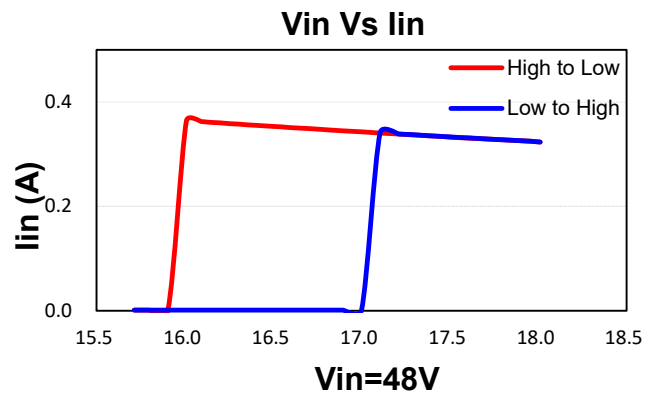
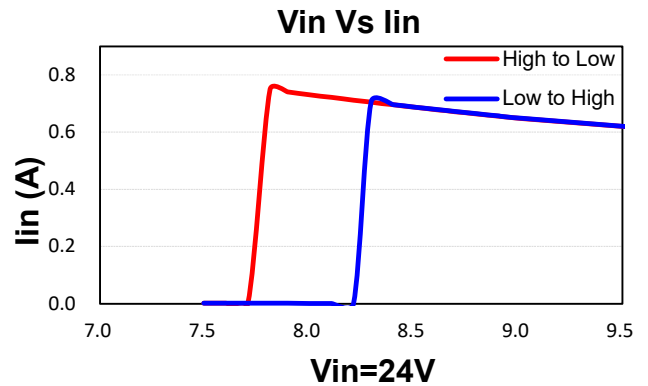

6.2 Over Current/Short Circuit Protection

All models have internal over current and continuous short circuit protection. The unit operates normally once the fault condition is removed. At the point of current limit inception, the converter will go into hiccup mode protection.

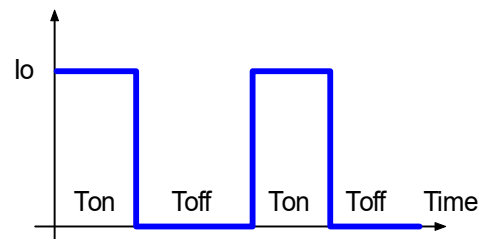
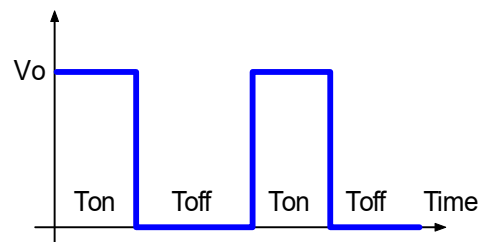



EC7AW Series Application Note V10

6.3 Output Over Voltage Protection

The over-voltage protection consists of a zener diode to limiting the out voltage.

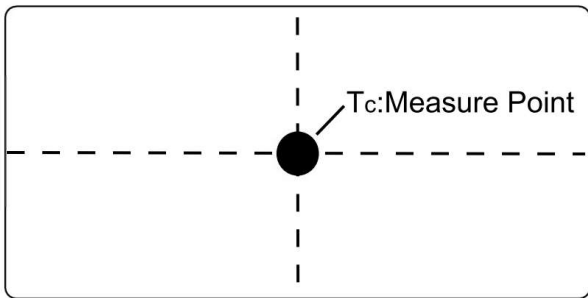

TOP VIEW

6.4 Remote On/Off

The EC7AW series allows the user to switch the module on and off electronically with the remote on/off feature. All models are available in “positive logic” and “negative logic” (optional) versions. The converter turns on if the remote On/Off pin is high (>3.5Vdc to 74Vdc or open circuit). Setting the pin low (0 to <1.2Vdc) will turn the converter off. The signal level of the remote on/off input is defined with respect to ground.

If not using the remote on/off pin, leave the pin open (converter will be on). Converter will be turn on in positive mode.

Models with part number suffix “N” are the “negative logic” remote on/off version. The unit turns off if the remote on/off pin is high (>3.5Vdc to 74Vdc or open circuit). The converter turns on if the On/Off pin input is low (0 to <1.2Vdc). Note that the converter is off by default.

Logic State (Pin 1)	Negative Logic	Positive Logic
Logic Low	Module on	Module off
Logic High	Module off	Module on

The converter remote on/off circuit built-in on input side. The ground pin of input side remote on/off circuit is -vin pin. Inside connection sees below.

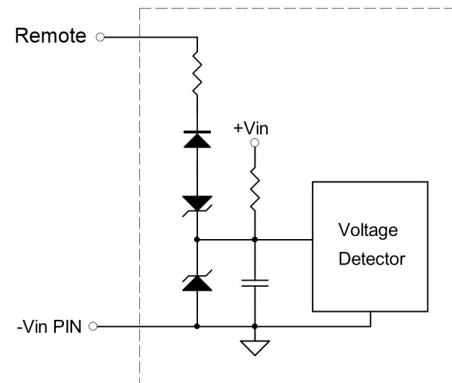

Connection examples see below.

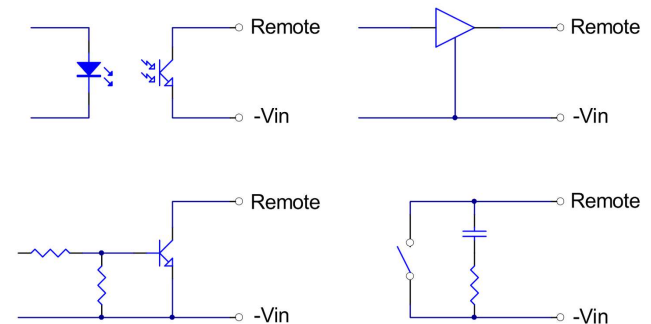

Remote On/Off Connection Examples

7. Input / Output Considerations

7.1 Input Capacitance at the Power Module

The converters must be connected to low AC source impedance. To avoid problems with loop stability source inductance should be low. Also, the input capacitors (Cin) should be placed close to the converter input pins to de-couple distribution inductance. However, the external input capacitors are chosen for suitable ripple handling capability. Low ESR capacitors are good choice. Circuit as shown as below represents typical measurement methods for reflected ripple current. C1 and L1 simulate a typical DC source impedance. The input reflected-ripple current is measured by current probe to oscilloscope with a simulated source Inductance (L1).

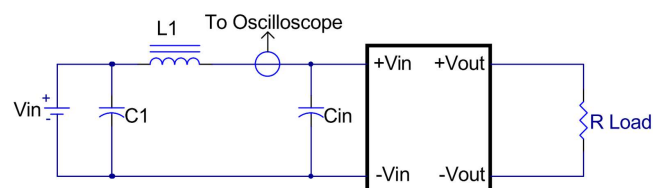

L1: 12uH

C1: None

Cin: 47uF ESR<0.17ohm @100KHz



EC7AW Series Application Note V10

7.2 Output Ripple and Noise

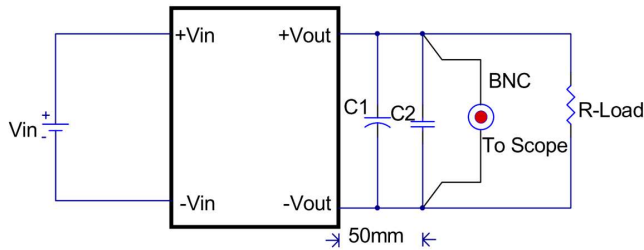

Note: C1: None, C2: 1uF ceramic capacitor.
EC7AW single output module

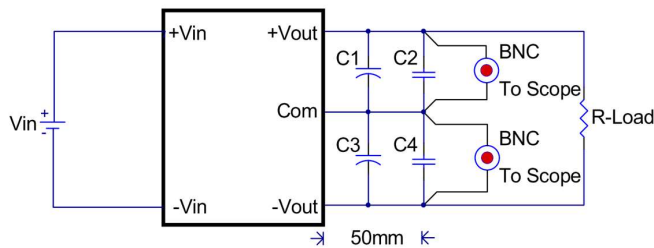

Note: C1 & C3: None, C2 & C4: 1uF ceramic capacitor.
EC7AW dual output module

Output ripple and noise measured with 1uF ceramic capacitor across output, A 20 MHz bandwidth oscilloscope is normally used for the measurement.

The conventional ground clip on an oscilloscope probe should never be used in this kind of measurement. This clip, when placed in a field of radiated high frequency energy, acts as an antenna or inductive pickup loop, creating an extraneous voltage that is not part of the output noise of the converter.



Another method is shown in below, in case of coaxial-cable/BNC is not available. The noise pickup is eliminated by pressing scope probe ground ring directly against the -Vout terminal while the tip contacts the +Vout terminal. This makes the shortest possible connection across the output terminals.

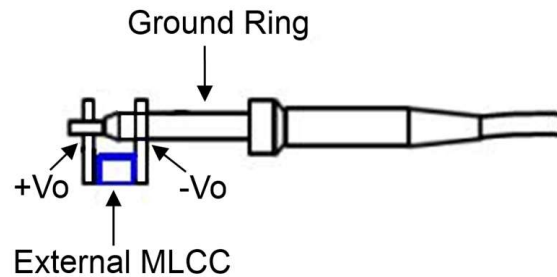

7.3 Output Capacitance

The EC7AW series converters provide unconditional stability with or without external capacitors. For good transient response, low ESR output capacitors should be located close to the point of load (<100mm). PCB design emphasizes low resistance and inductance tracks in consideration of high current applications. Output capacitors with their associated ESR values have an impact on loop stability and bandwidth. Cincon's converters are designed to work with load capacitance to see technical specifications.



EC7AW Series Application Note V10

8. Thermal Design

8.1 Operating Temperature Range

The EC7AW series converters can be operated within a wide case temperature range of -40°C to 85°C . Consideration must be given to the derating curves when ascertaining maximum power that can be drawn from the converter. The maximum power drawn from models is influenced by usual factors, such as:

- Input voltage range
- Output load current
- Forced air or natural convection

8.2 Convection Requirements for Cooling

To predict the approximate cooling needed for the $1.25'' \times 0.8''$ module, refer to the power derating curves in **datasheet**. These derating curves are approximations of the ambient temperatures and airflows required to keep the power module temperature below its maximum rating. Once the module is assembled in the actual system, the module's temperature should be monitored to ensure it does not exceed 105°C as measured at the center of the top of the case (thus verifying proper cooling).

8.3 Thermal Considerations

The power module operates in a variety of thermal environments; however, sufficient cooling should be provided to help ensure reliable operation of the unit. Heat is removed by conduction, convection, and radiation to the surrounding environment. The example is presented in **datasheet**. The power output of the module should not be allowed to exceed rated power ($V_{o_set} \times I_{o_max}$).

8.4 Power Derating

The operating case temperature range of EC7AW series is -40°C to $+85^{\circ}\text{C}$. When operating the EC7AW series, proper derating or cooling is needed. The maximum case temperature under any operating condition should not exceed 105°C (refer to datasheet).



EC7AW Series Application Note V10

9. Safety & EMC

9.1 Input Fusing and Safety Considerations

The EC7AW series converters have no internal fuse. In order to achieve maximum safety and system protection, always use an input line fuse. We recommended a fast acting fuse 3A for 24Vin models and 1.5A for 48Vin modules. It is recommended that the circuit have a transient voltage suppressor diode (TVS) across the input terminal to protect the unit against surge or spike voltage and input reverse voltage (as shown).

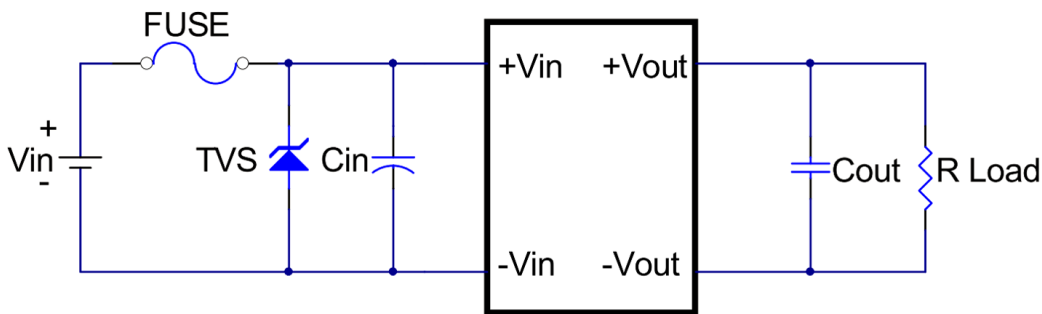

The external TVS & input capacitor (Cin) is required if EC7AW series has to meet EN61000-4-4 & EN61000-4-5. The EC7AW series recommended a TVS (SECOS SMDJ180A-C) & aluminum capacitor (120uF/220V) to connect parallel.

9.2 EMC Considerations

EMI Test standard: EN55032 Conducted & Radiated Emission
 Test Condition: Input Voltage: Nominal, Output Load: Full Load
 (1) EMI meet EN55032

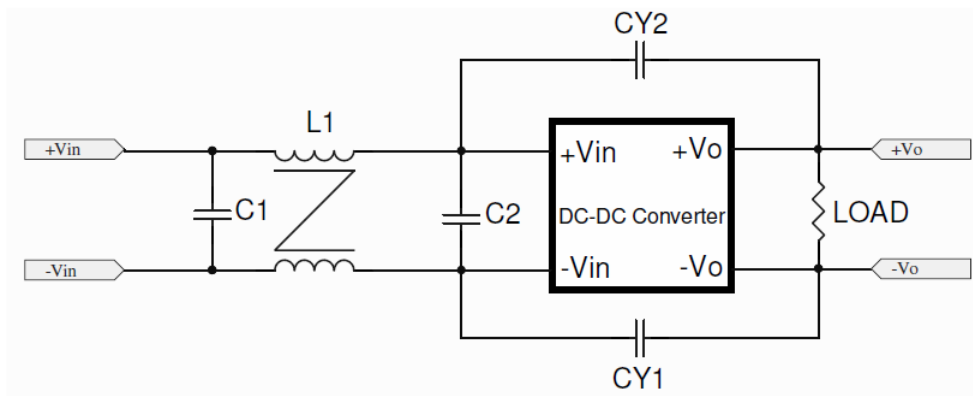

Model Number		C1	C2	CY1	CY2	L1
Class A	EC7AW-24XXX	None	None	None	None	Jumper wire*2 Φ0.6mm
	EC7AW-48XXX					
Class B	EC7AW-24XXX	4.7uF/100V 1812	4.7uF/100V 1812	1000pF/4KV 1808	NONE	1.0mm/14T FCNO179C
	EC7AW-48XXX					

Note:
 C1, C2: 1812 X7R ceramic capacitor.
 CY1, 1808 X7R ceramic capacitor.
 L1: 1.0mm/14T 1mH MIN CINCON V1.0 CMCK DIP FCNO179C (G91C7425315).



EC7AW Series Application Note V10

Conducted Emission Class A:

EC7AW-24S33

Line

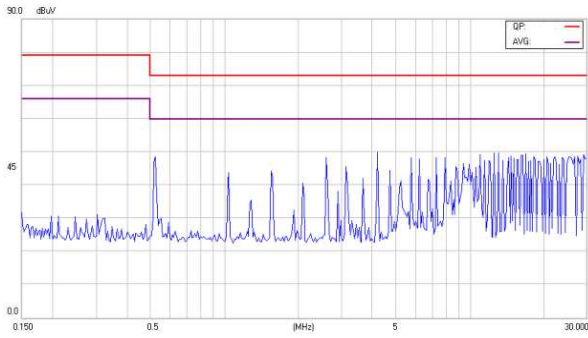

Neutral

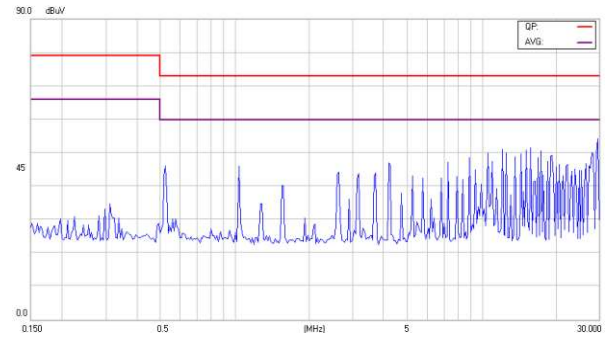

EC7AW-24S05

Line

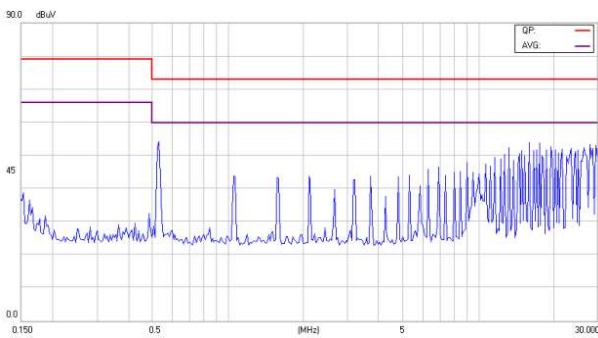

Neutral

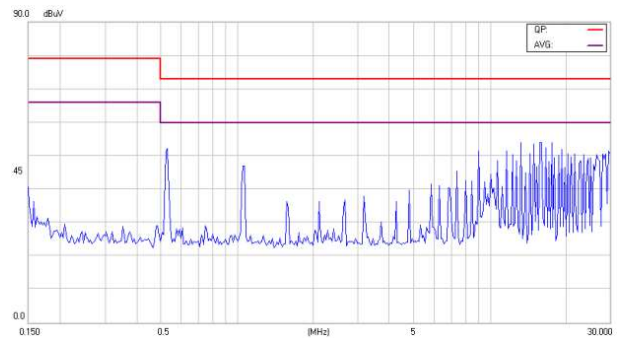

EC7AW-24S12

Line

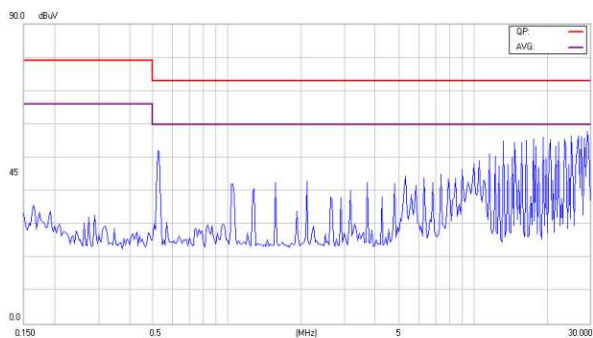

Neutral

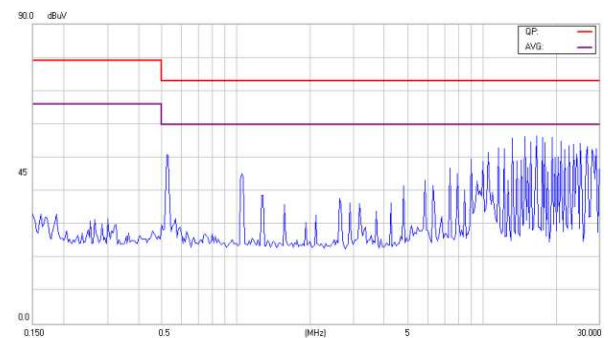

EC7AW-24S15

Line

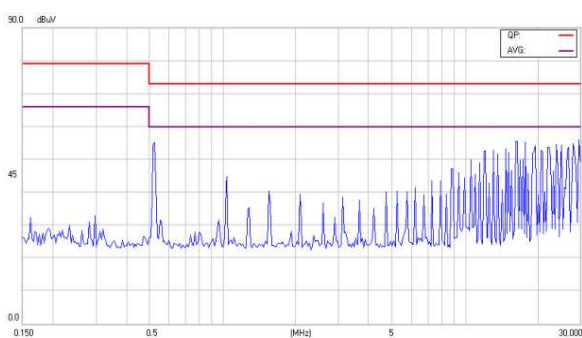

Neutral

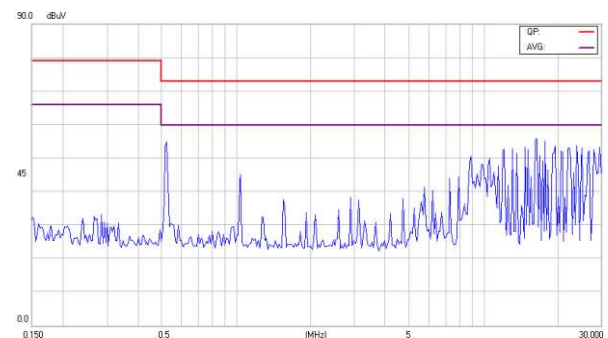



EC7AW Series Application Note V10

EC7AW-24D12

Line

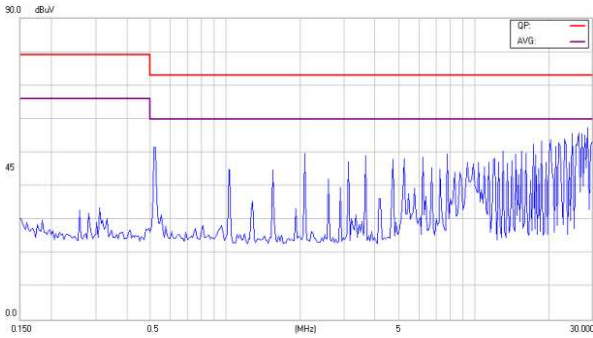

Neutral

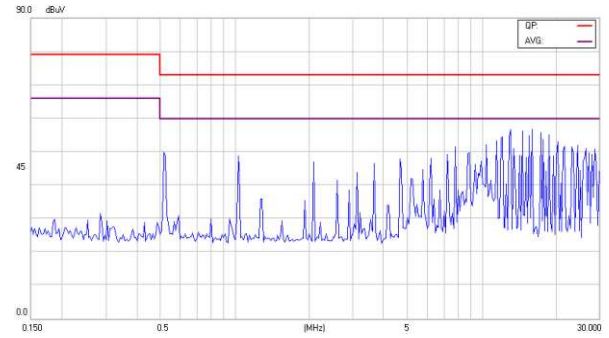

EC7AW-24D15

Line

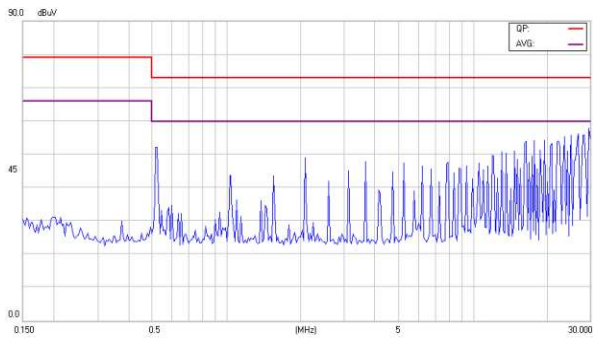

Neutral

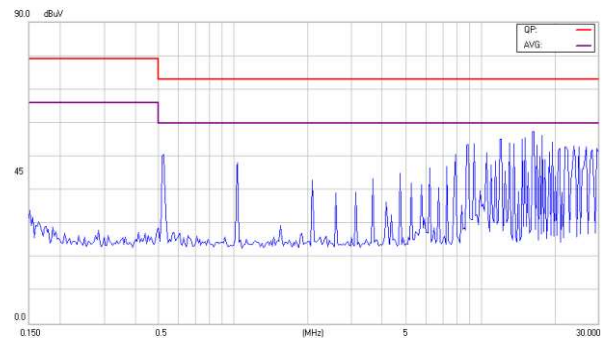

EC7AW-48S33

Line

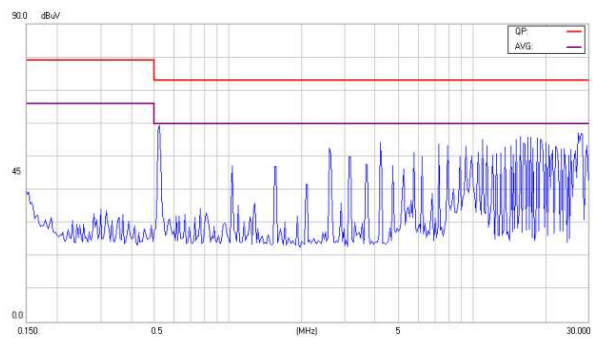

Neutral

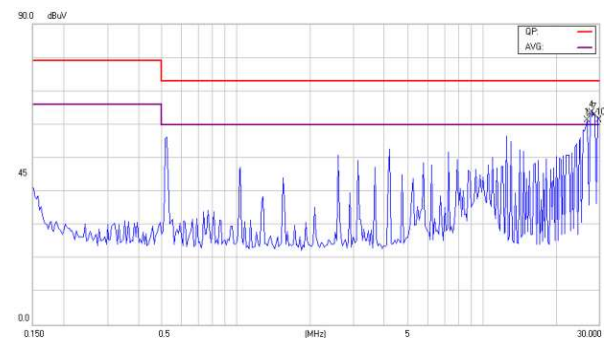

EC7AW-48S05

Line

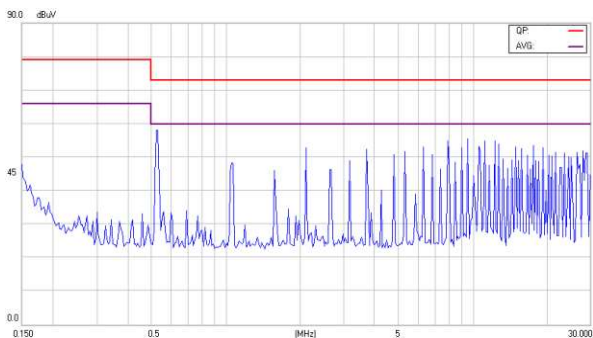

Neutral

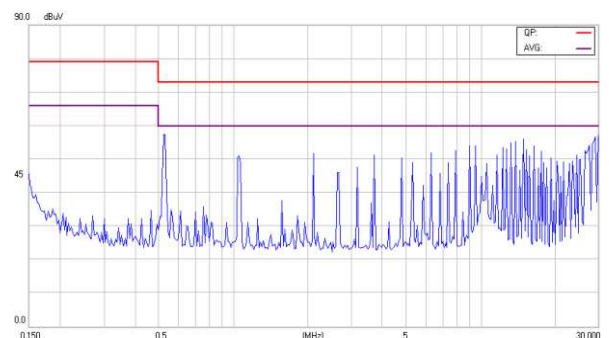



EC7AW Series Application Note V10

EC7AW-48S12

Line

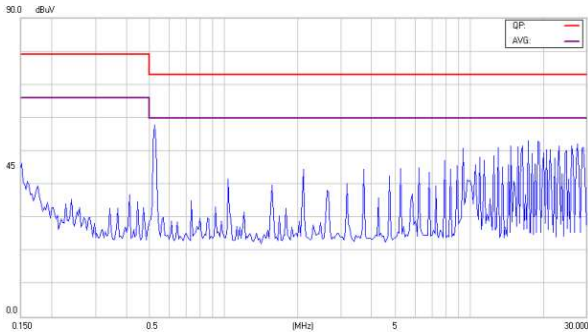

Neutral

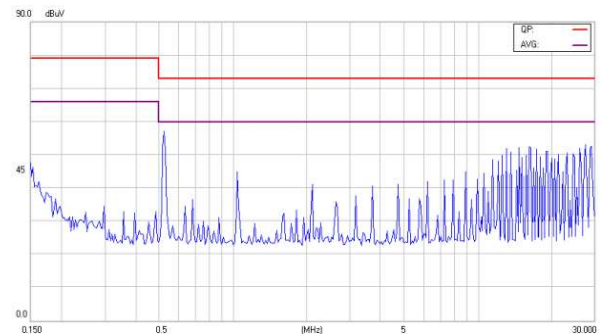

EC7AW-48S15

Line

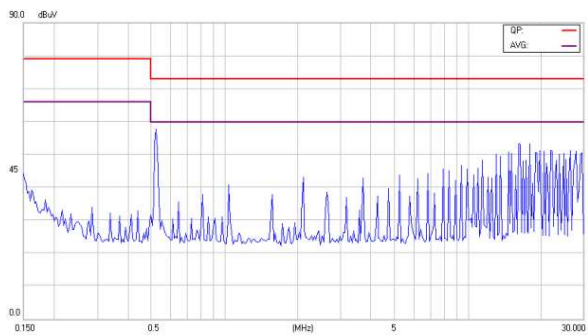

Neutral

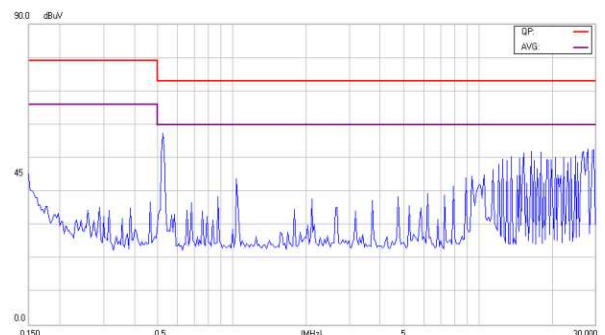

EC7AW-48D12

Line

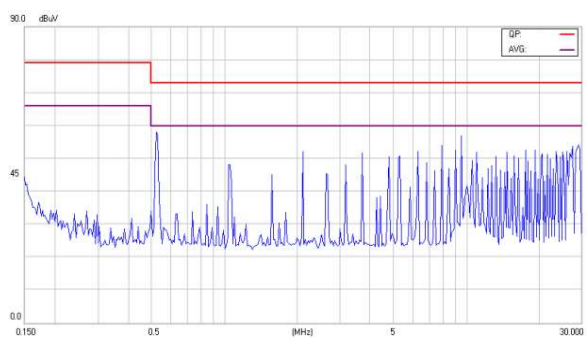

Neutral

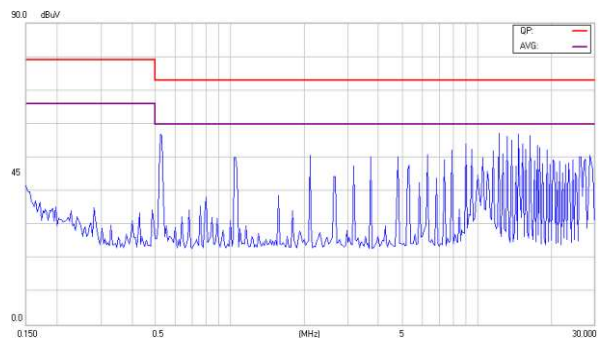

EC7AW-48D15

Line

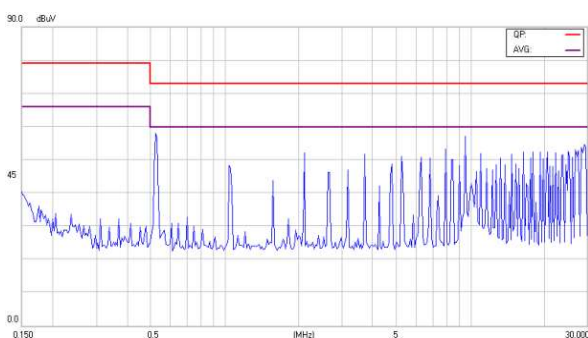

Neutral

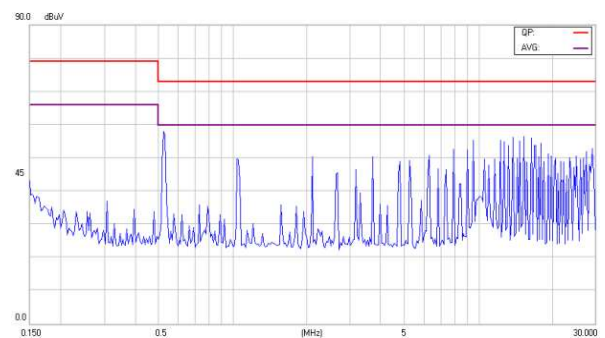



EC7AW Series Application Note V10

Radiated Emission Class A:

EC7AW-24S33

Horizontal

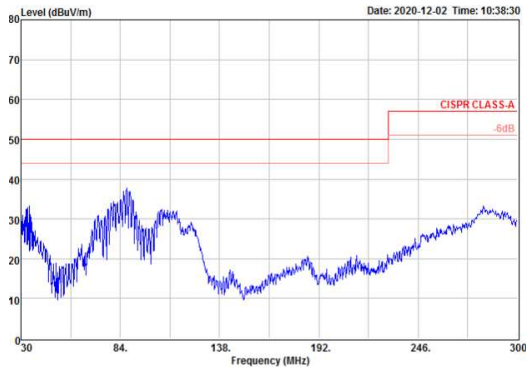

Vertical

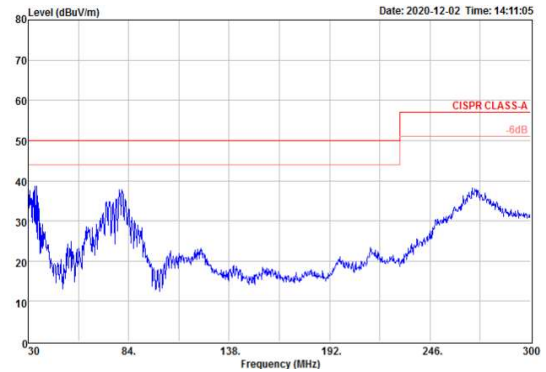

EC7AW-24S05

Horizontal

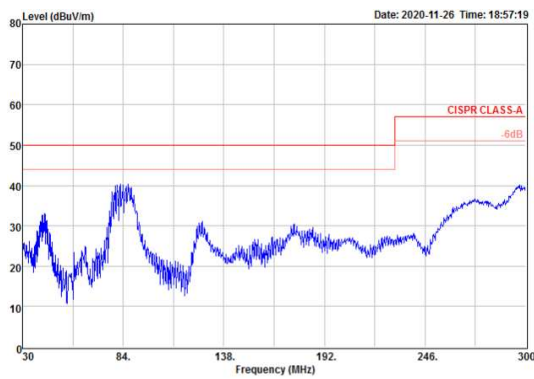

Vertical

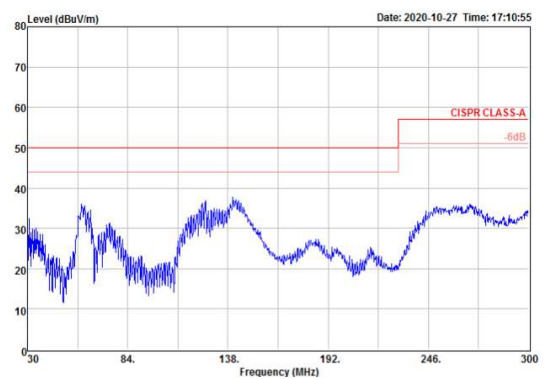

EC7AW-24S12

Horizontal

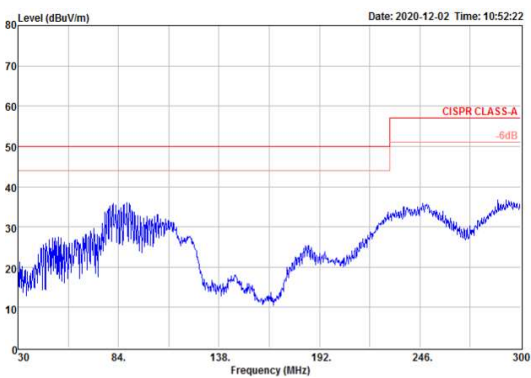

Vertical

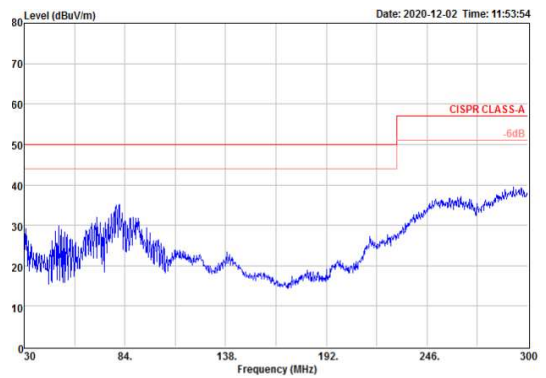



EC7AW Series Application Note V10

EC7AW-24S15

Horizontal

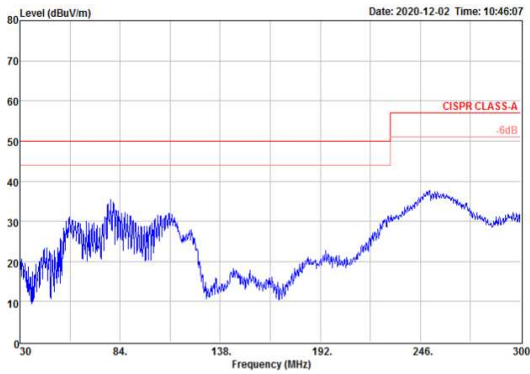

Vertical

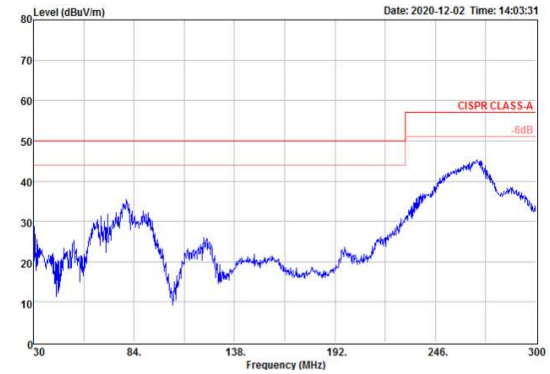

EC7AW-24D12

Horizontal

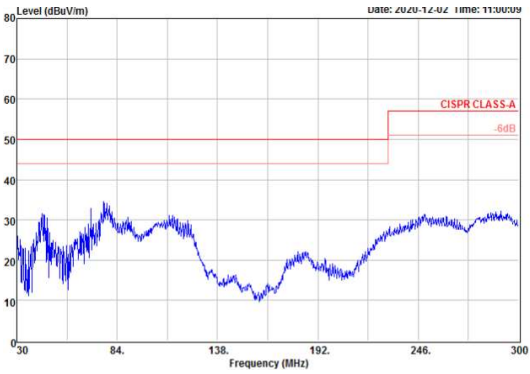

Vertical

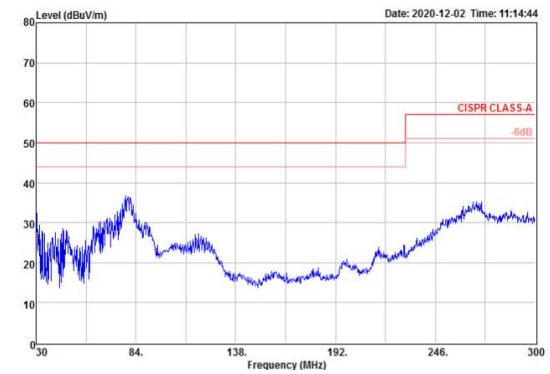

EC7AW-24D15

Horizontal

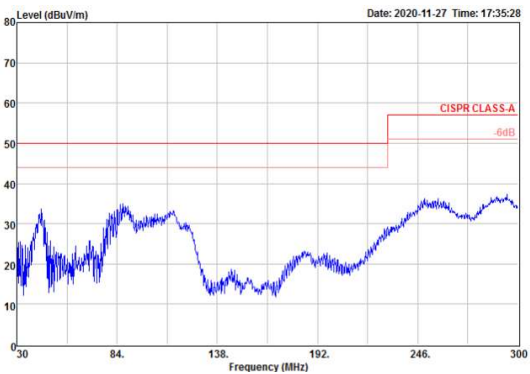

Vertical

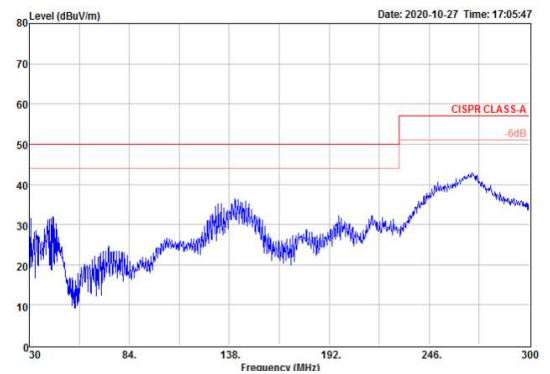



EC7AW Series Application Note V10

EC7AW-48S33

Horizontal

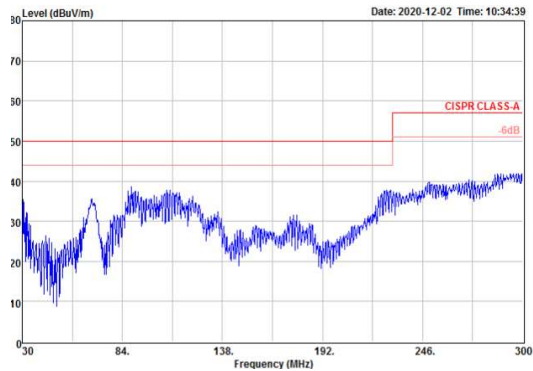

Vertical

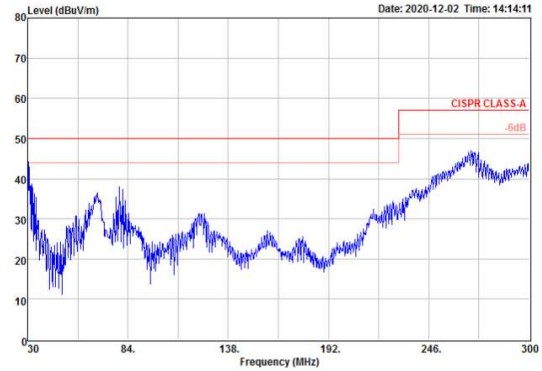

EC7AW-48S05

Horizontal

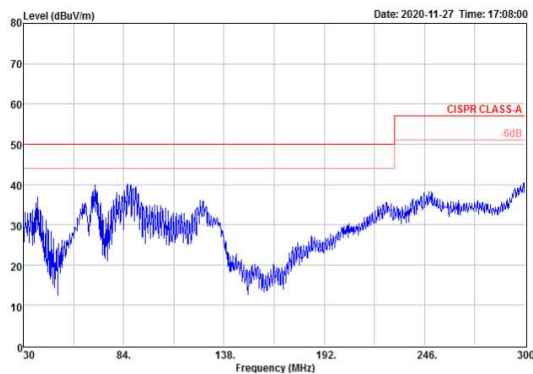

Vertical

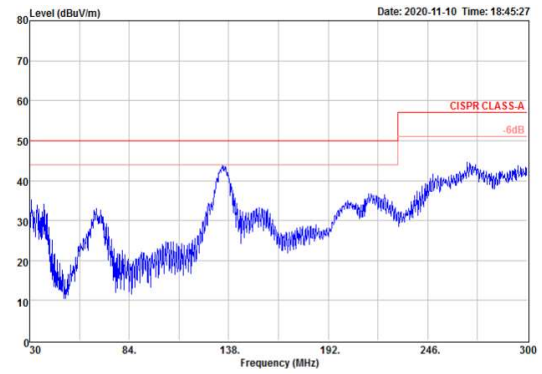

EC7AW-48S12

Horizontal

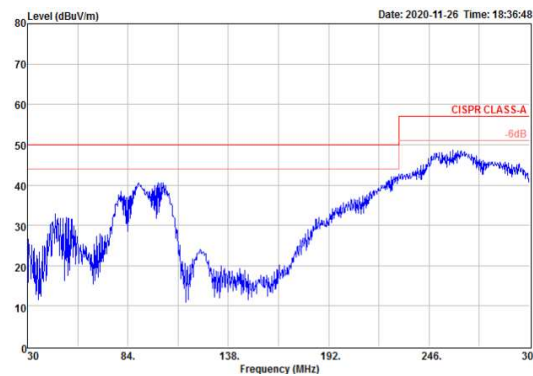

Vertical

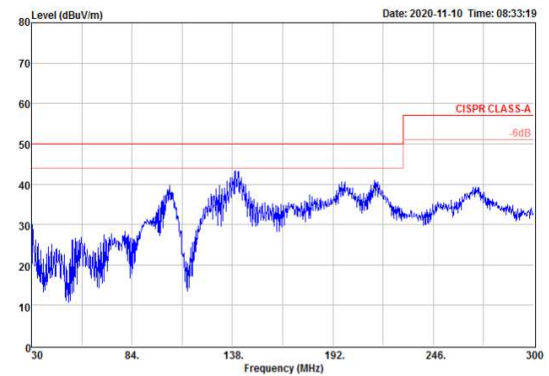



EC7AW Series Application Note V10

EC7AW-48S15

Horizontal

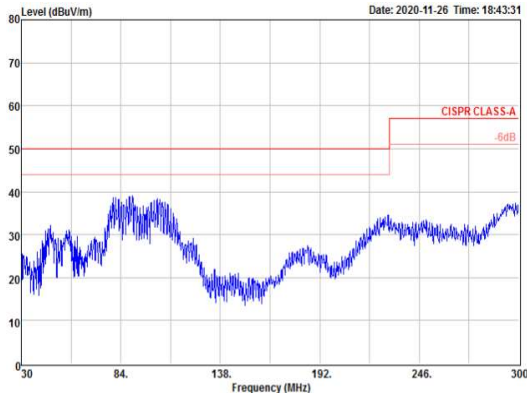

Vertical

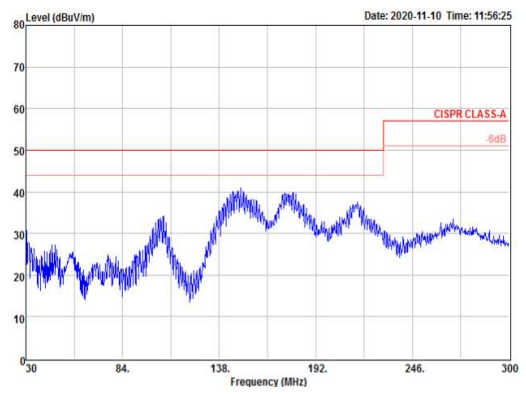

EC7AW-48D12

Horizontal

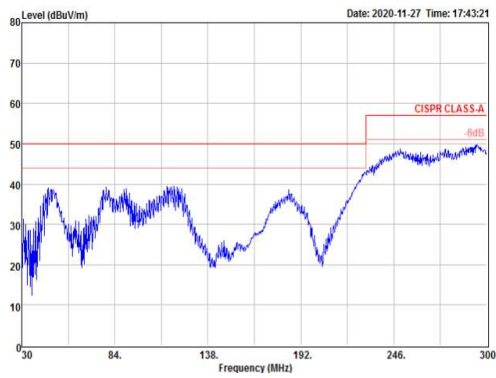

Vertical

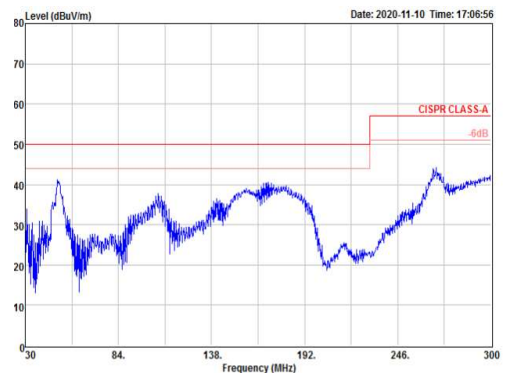

EC7AW-48D15

Horizontal

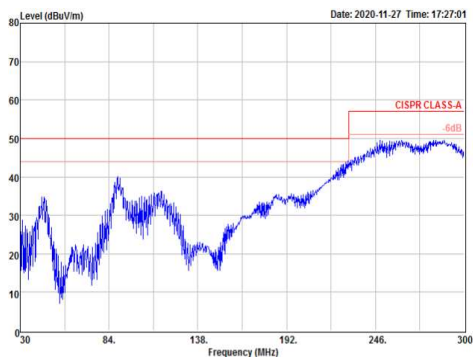

Vertical

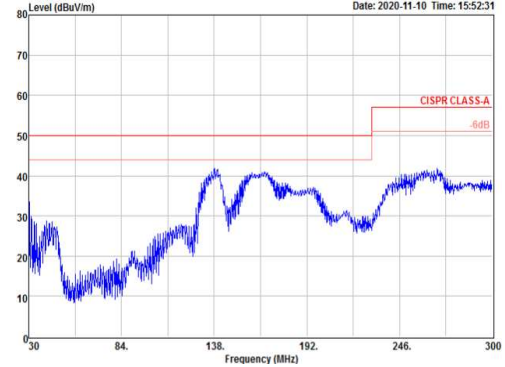



EC7AW Series Application Note V10

Conducted Emission Class B:

EC7AW-24S33

Line

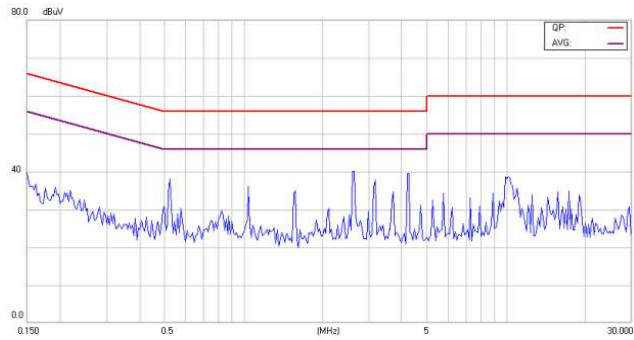

Neutral

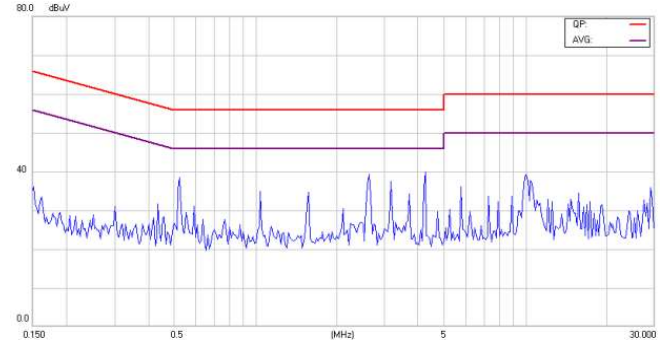

EC7AW-24S05

Line

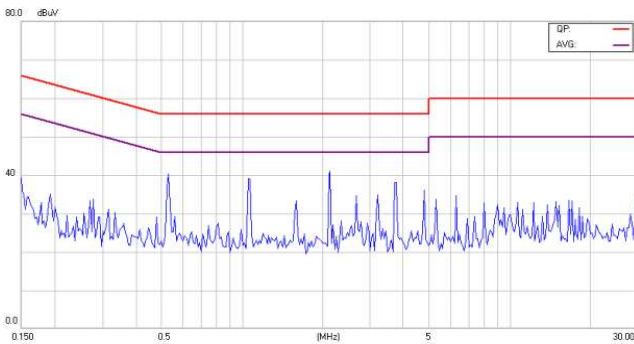

Neutral

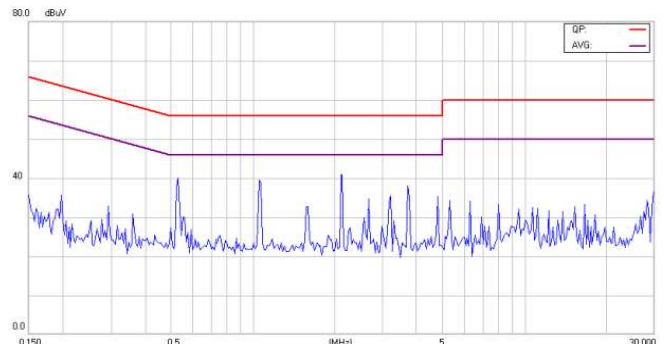

EC7AW-24S12

Line

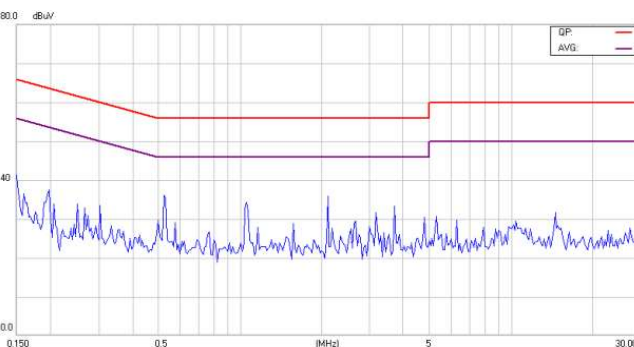

Neutral

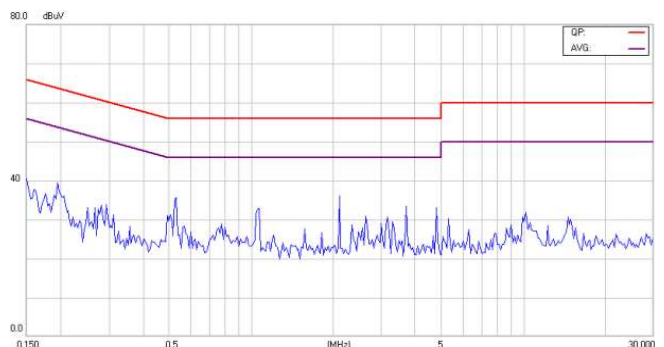

EC7AW-24S15

Line

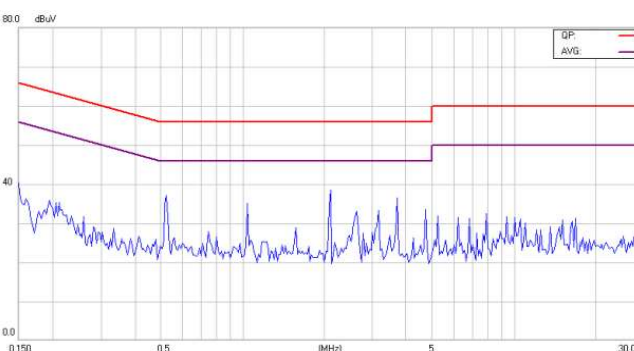

Neutral

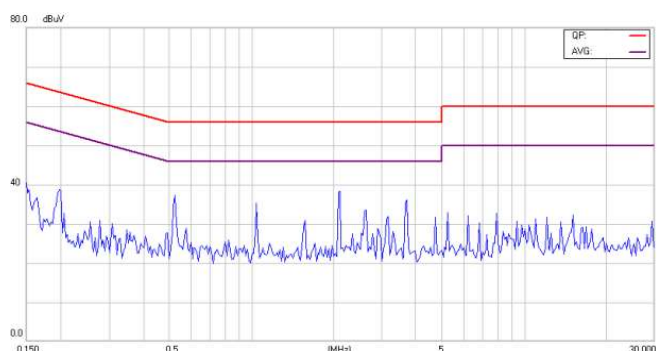



EC7AW Series Application Note V10

EC7AW-24D12

Line

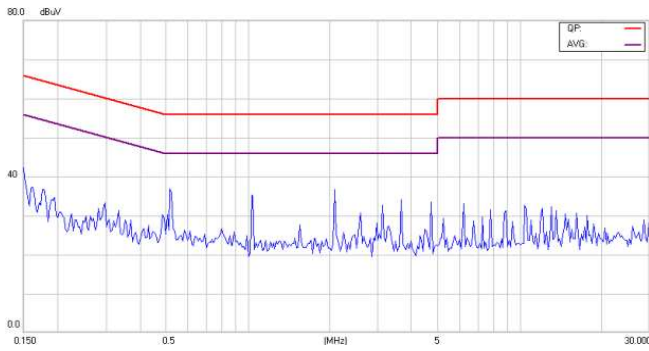

Neutral



EC7AW-24D15

Line

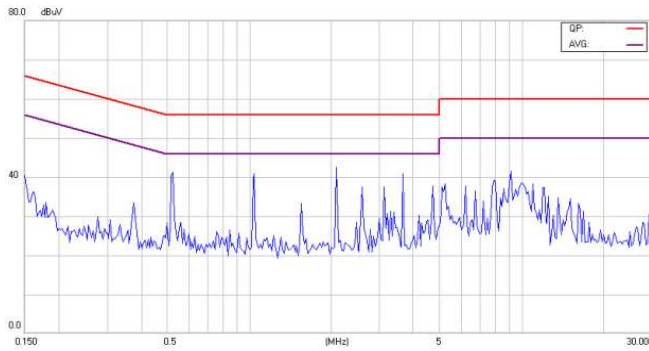

Neutral

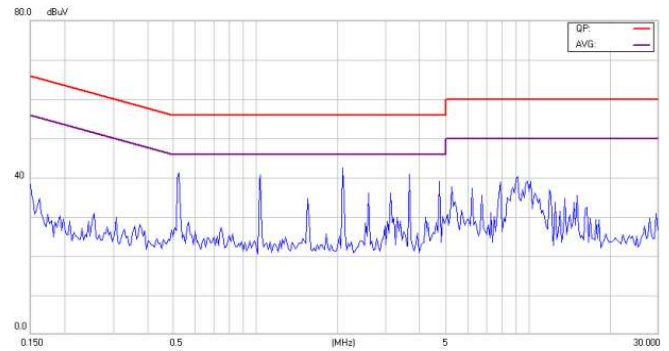

EC7AW-48S33

Line

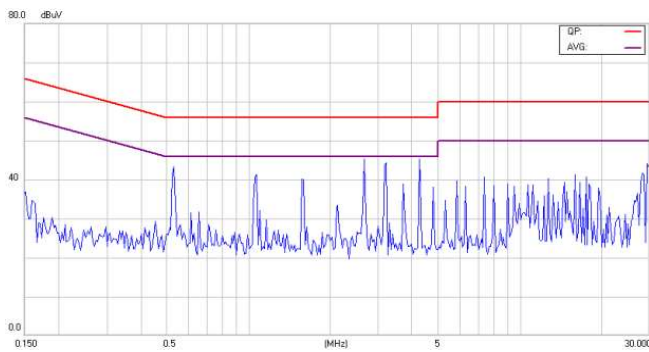

Neutral

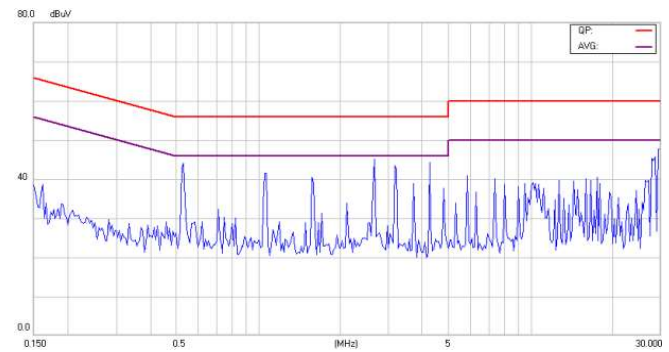

EC7AW-48S05

Line

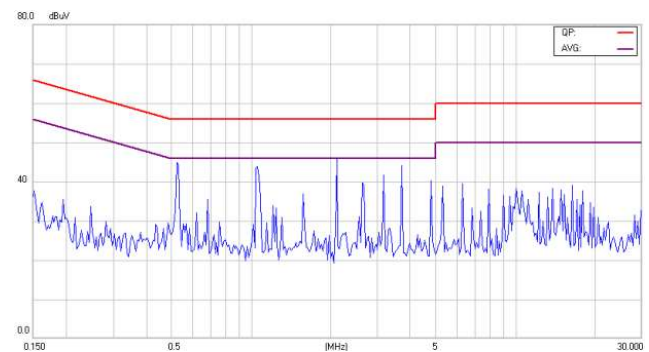

Neutral

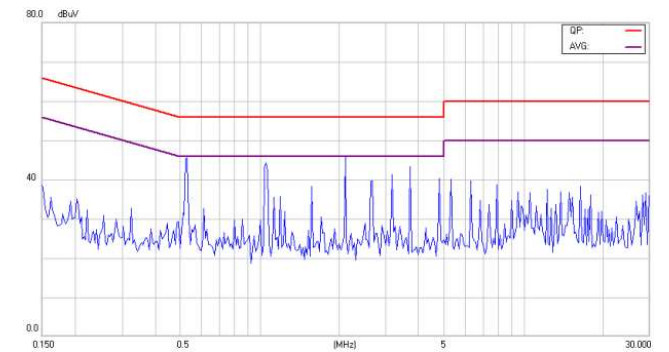



EC7AW Series Application Note V10

EC7AW-48S12

Line

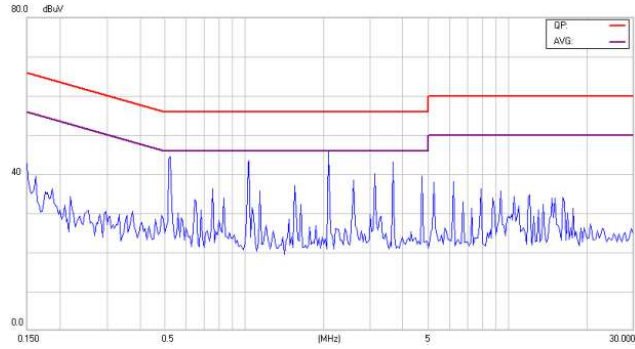

Neutral

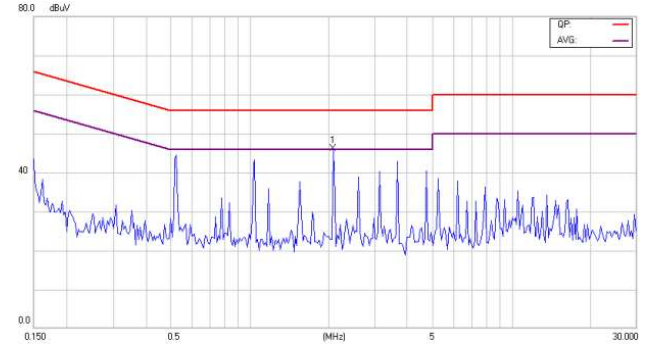

EC7AW-48S15

Line

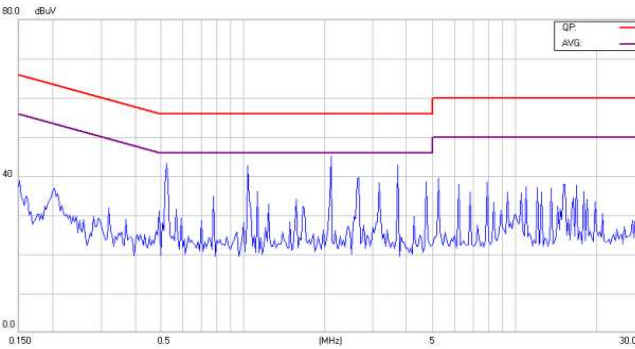

Neutral

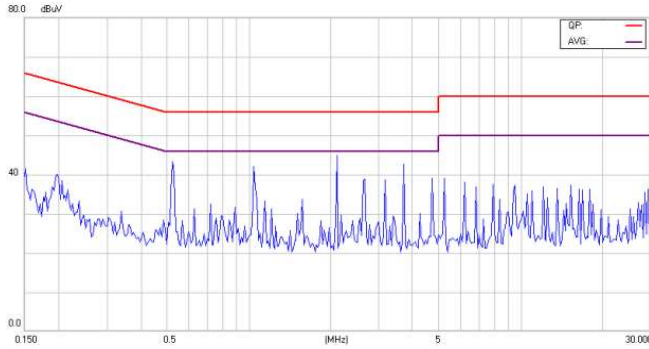

EC7AW-48D12

Line

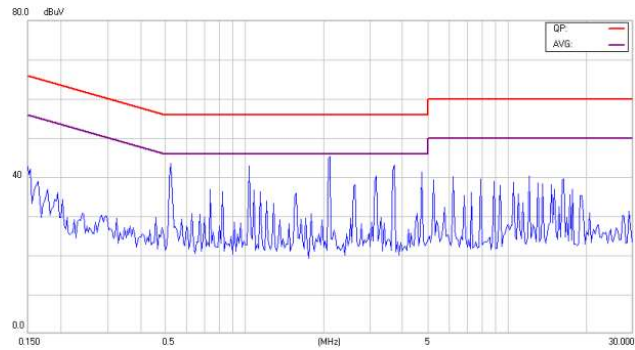

Neutral

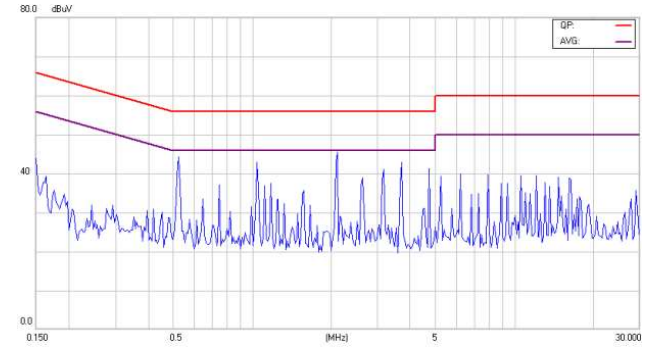

EC7AW-48D15

Line

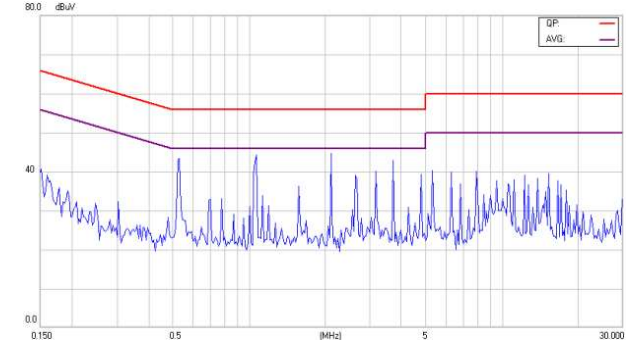

Neutral

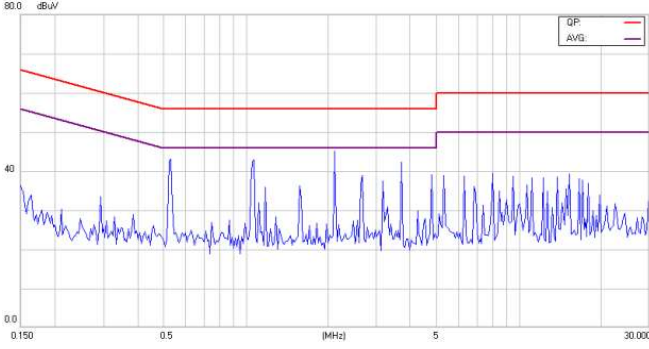



EC7AW Series Application Note V10

Radiated Emission Class B:

EC7AW-24S33

Horizontal

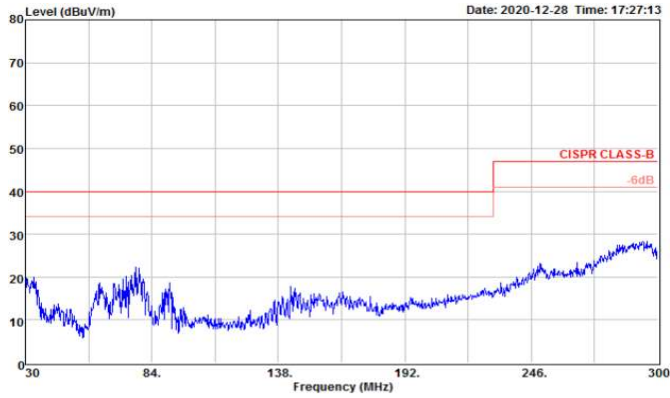

Vertical



EC7AW-24S05

Horizontal

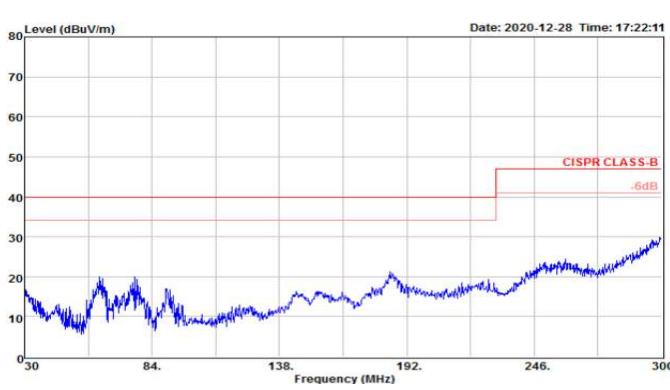

Vertical

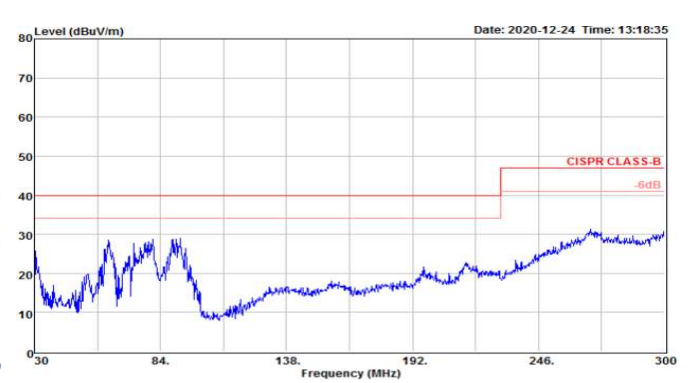

EC7AW-24S12

Horizontal

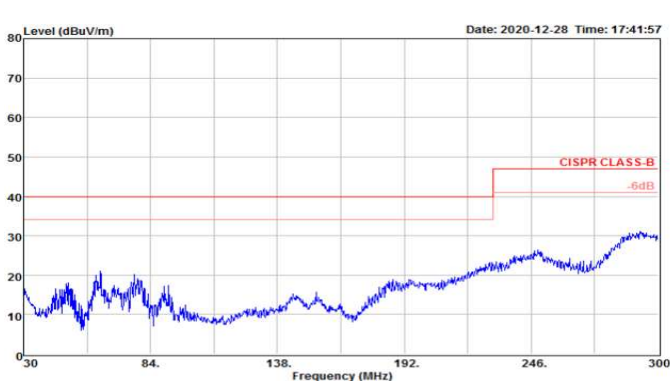

Vertical

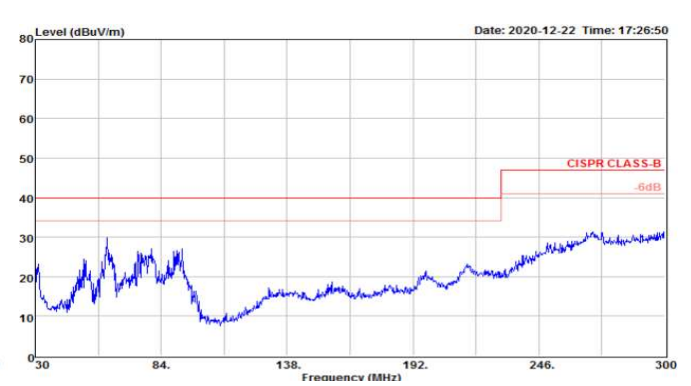



EC7AW Series Application Note V10

EC7AW-24S15

Horizontal

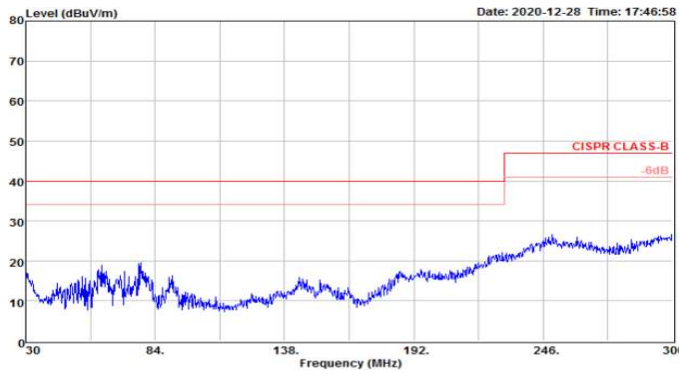

Vertical

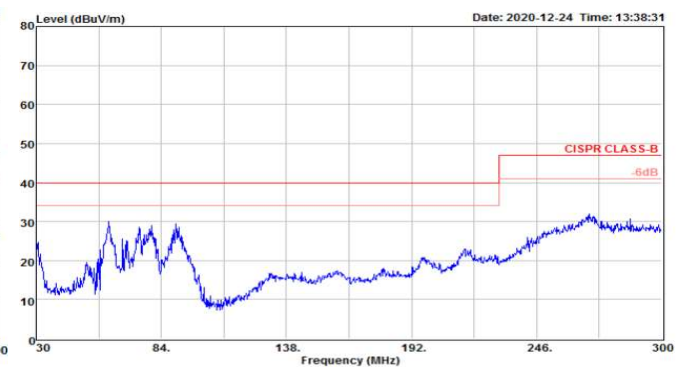

EC7AW-24D12

Horizontal

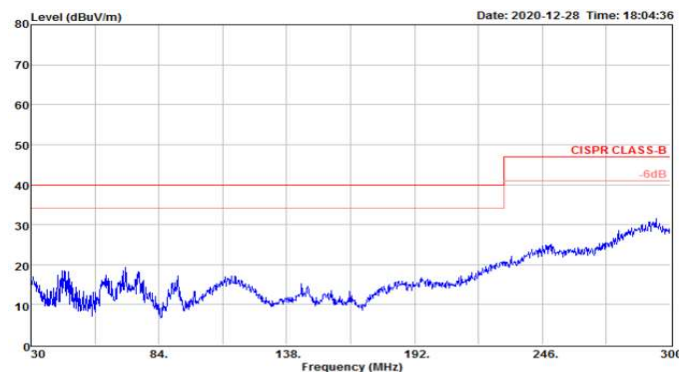

Vertical

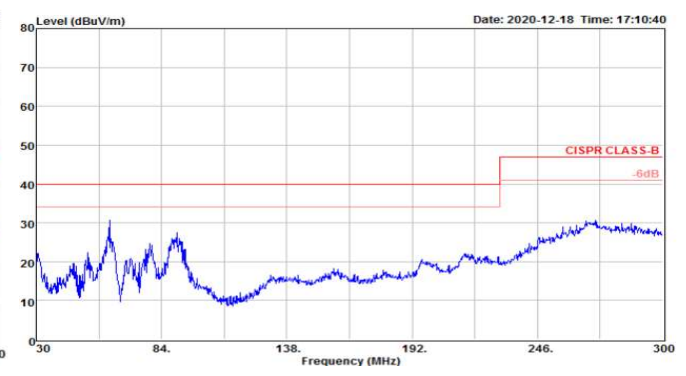

EC7AW-24D15

Horizontal

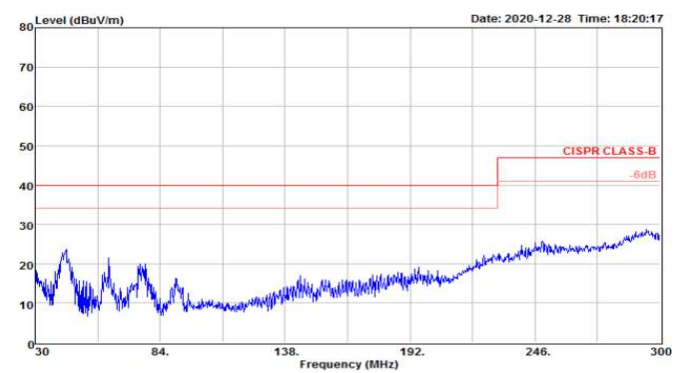

Vertical

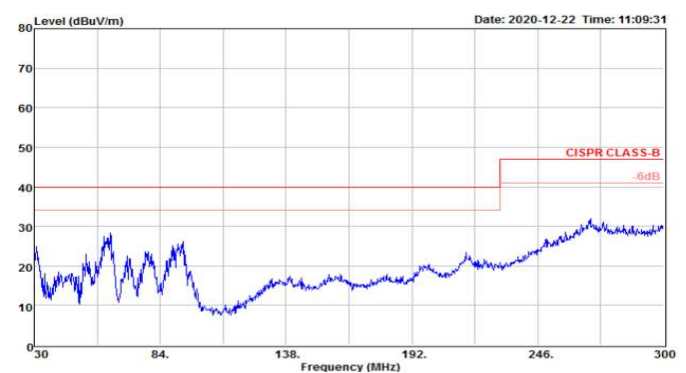



EC7AW Series Application Note V10

EC7AW-48S33

Horizontal

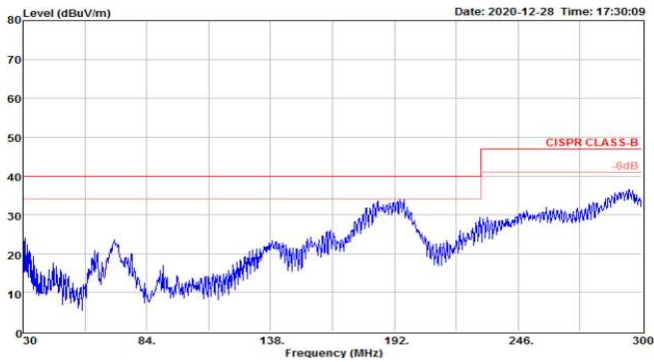

Vertical

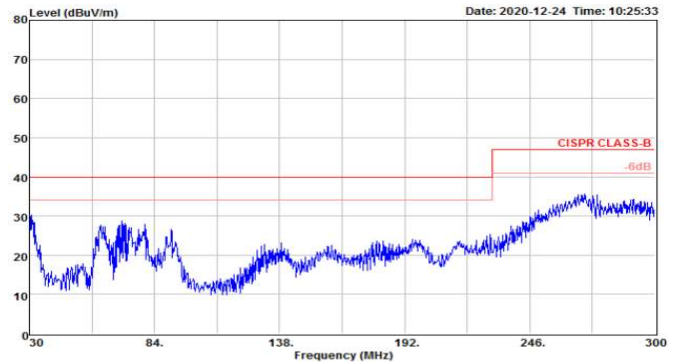

EC7AW-48S05

Horizontal

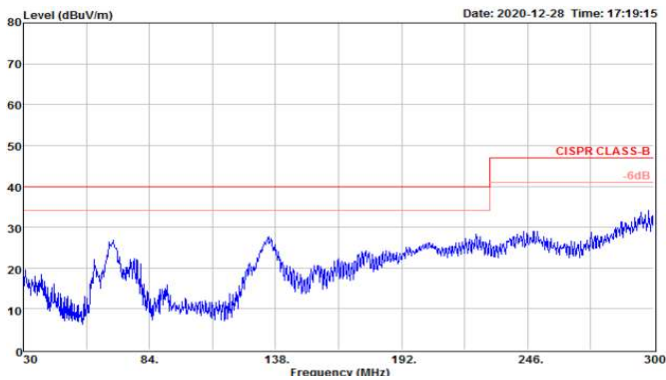

Vertical

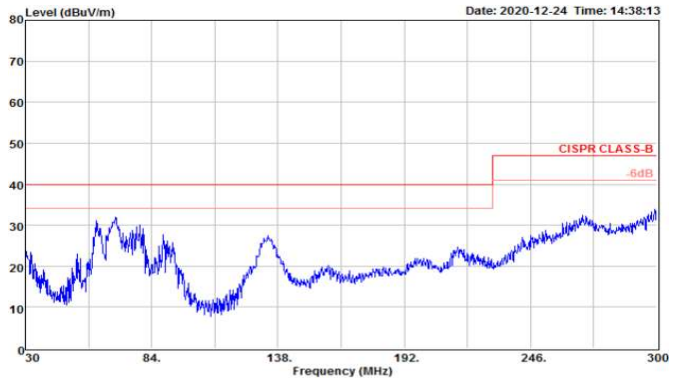

EC7AW-48S12

Horizontal

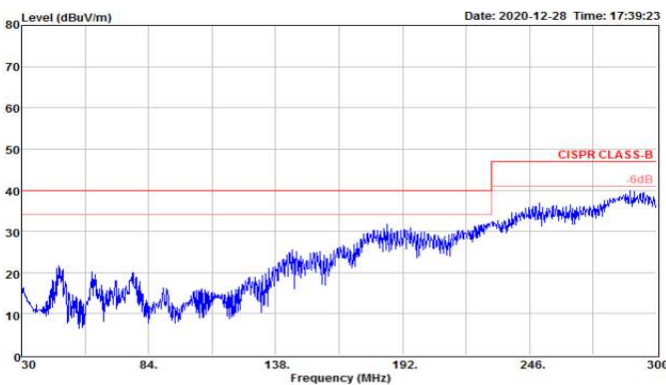

Vertical

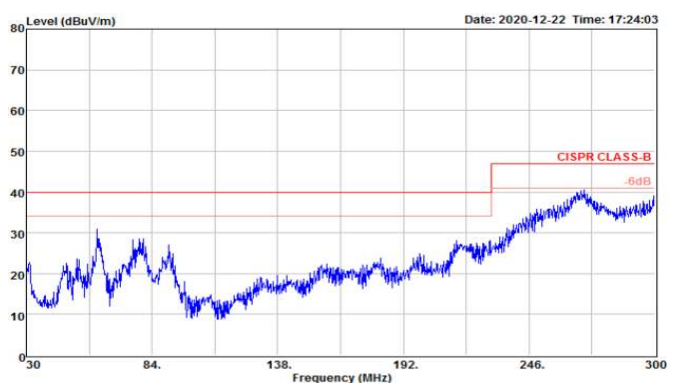



EC7AW Series Application Note V10

EC7AW-48S15

Horizontal

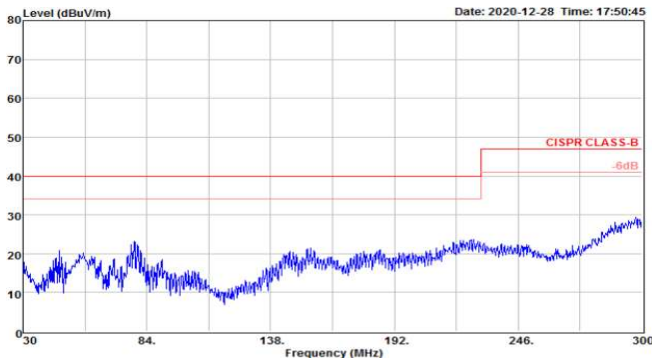

Vertical

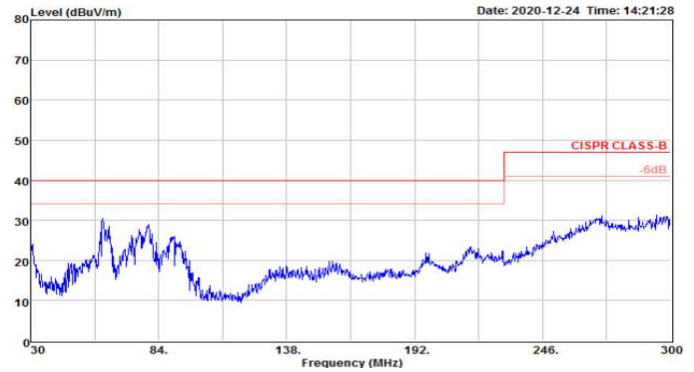

EC7AW-48D12

Horizontal

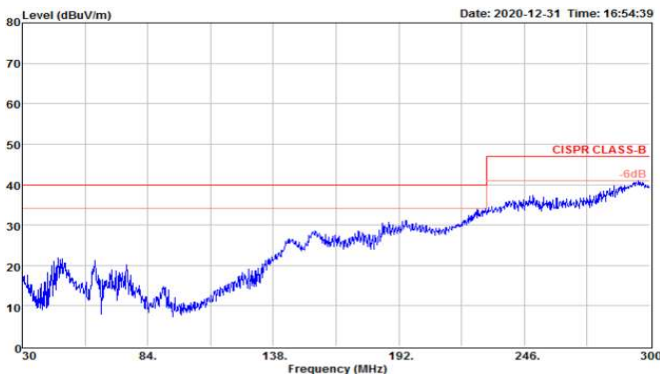

Vertical

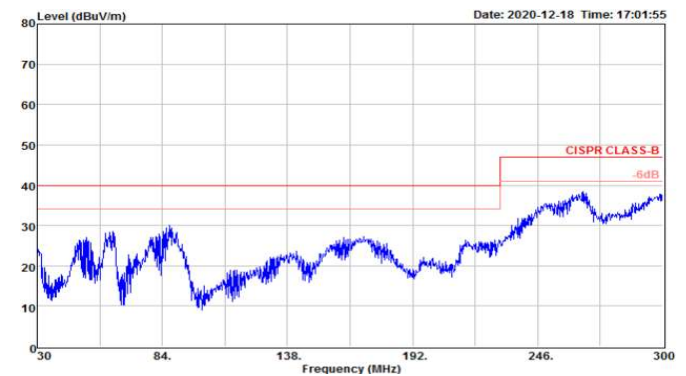

EC7AW-48D15

Horizontal

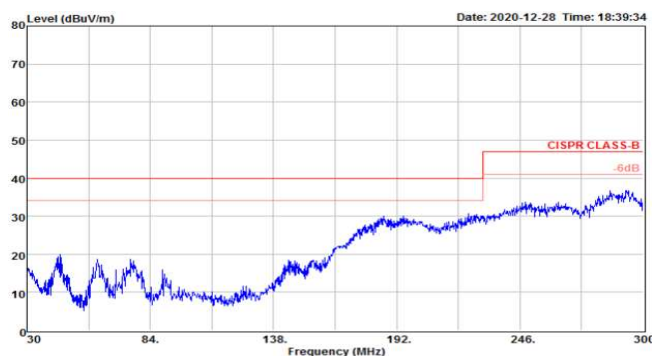

Vertical

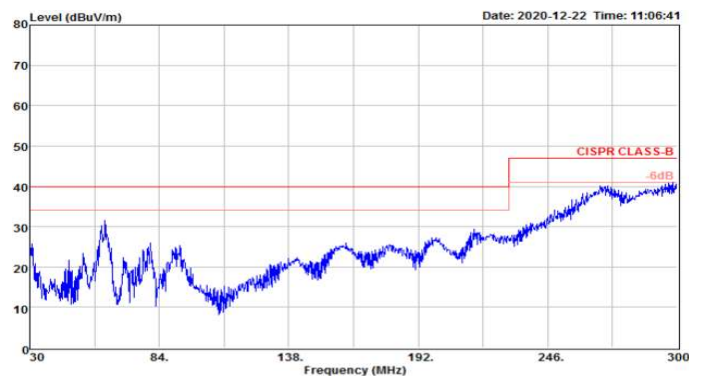

CINCON ELECTRONICS CO., LTD.

Headquarters:

14F, No.306, Sec.4, Hsin Yi Rd.
Taipei, Taiwan
Tel: 886-2-27086210
Fax: 886-2-27029852
E-mail: support@cincon.com.tw
Web: www.cincon.com

Factory:

No. 8-1, Fu Kung Rd.
Fu Hsing Industrial Park
Fu Hsing Hsiang,
ChangHua Hsien, Taiwan
Tel: 886-4-7690261
Fax: 886-4-7698031

Cincon North America:

1655Mesa Verde Ave. Ste 180
Ventura, CA93003
Tel: 805-639-3350
Fax: 805-639-4101
E-mail: info@cincon.com