

Printed-circuit board connector - FK-MCP 1,5/ 9-STF-3,81 - 1851300

Please be informed that the data shown in this PDF Document is generated from our Online Catalog. Please find the complete data in the user's documentation. Our General Terms of Use for Downloads are valid (<http://download.phoenixcontact.com>)

Plug component, Nominal current: 8 A, Rated voltage (III/2): 160 V, Number of positions: 9, Pitch: 3.81 mm, Connection method: Spring-cage conn., Color: green, Contact surface: Tin

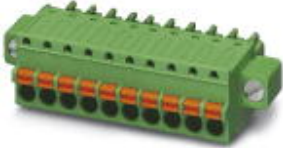

The figure shows a 10-position version of the product

Product Features

- User-friendly actuation of the terminal point using a screwdriver
- Fast conductor connection thanks to Push-in spring-cage connection
- Wide range of possible combinations with MC base strips with 3.5/3.81 mm pitch
- Test connection for accommodating 1.2 mm Ø test pins or 1 mm Ø test plugs



Key commercial data

Packing unit	1 PCE
Minimum order quantity	50 PCE
GTIN	 4 017918 110093
Custom tariff number	85366990
Country of origin	GERMANY

Technical data

Dimensions / positions

Pitch	3.81 mm
Dimension a	30.48 mm
Number of positions	9

Technical data

Range of articles	FK-MCP 1,5/...STF
Insulating material group	I

Printed-circuit board connector - FK-MCP 1,5/ 9-STF-3,81 - 1851300

Technical data

Technical data

Rated surge voltage (III/3)	2.5 kV
Rated surge voltage (III/2)	2.5 kV
Rated surge voltage (II/2)	2.5 kV
Rated voltage (III/2)	160 V
Rated voltage (II/2)	320 V
Connection in acc. with standard	EN-VDE
Nominal current I_N	8 A
Nominal voltage U_N	160 V
Nominal cross section	1.5 mm ²
Maximum load current	8 A (with 1.5 mm ² conductor cross section)
Insulating material	PA
Inflammability class according to UL 94	V0
Internal cylindrical gage	A1
Stripping length	9 mm
Nominal voltage, UL/CUL Use Group B	300 V
Nominal current, UL/CUL Use Group B	8 A
Nominal voltage, UL/CUL Use Group D	300 V
Nominal current, UL/CUL Use Group D	8 A

Connection data

Conductor cross section solid min.	0.14 mm ²
Conductor cross section solid max.	1.5 mm ²
Conductor cross section stranded min.	0.14 mm ²
Conductor cross section stranded max.	1.5 mm ²
Conductor cross section stranded, with ferrule without plastic sleeve min.	0.25 mm ²
Conductor cross section stranded, with ferrule without plastic sleeve max.	1.5 mm ²
Conductor cross section stranded, with ferrule with plastic sleeve min.	0.25 mm ²
Conductor cross section stranded, with ferrule with plastic sleeve max.	0.5 mm ²
Conductor cross section AWG/kcmil min.	26
Conductor cross section AWG/kcmil max	16
Minimum AWG according to UL/CUL	28
Maximum AWG according to UL/CUL	16

Classifications

ETIM

ETIM 3.0	EC001121
----------	----------

Printed-circuit board connector - FK-MCP 1,5/ 9-STF-3,81 - 1851300

Classifications

ETIM

ETIM 4.0	EC002638
ETIM 5.0	EC002638

UNSPSC

UNSPSC 11	39121409
UNSPSC 12.01	39121409
UNSPSC 13.2	39121409
UNSPSC 6.01	30211810
UNSPSC 7.0901	39121409

eCl@ss

eCl@ss 4.0	272607xx
eCl@ss 4.1	27260701
eCl@ss 5.0	27260701
eCl@ss 5.1	27260701
eCl@ss 6.0	27260704
eCl@ss 7.0	27440402

Approvals

Approvals

Approvals

CSA / UL Recognized / VDE Gutachten mit Fertigungsüberwachung / cUL Recognized / GOST / IECCEB Scheme / GOST / CCA / cULus Recognized

Ex Approvals

Approvals submitted

Approval details

CSA 		
	B	D
mm ² /AWG/kcmil	28-16	28-16

Printed-circuit board connector - FK-MCP 1,5/ 9-STF-3,81 - 1851300

Approvals

	B	D
Nominal current I _N	8 A	8 A
Nominal voltage U _N	300 V	300 V

UL Recognized 

	B	D
mm ² /AWG/kcmil	28-16	28-16
Nominal current I _N	8 A	8 A
Nominal voltage U _N	300 V	300 V

VDE Gutachten mit Fertigungsüberwachung 

mm ² /AWG/kcmil	0.2-1.5
Nominal current I _N	8 A
Nominal voltage U _N	160 V

cUL Recognized 

	B	D
mm ² /AWG/kcmil	28-16	28-16
Nominal current I _N	8 A	8 A
Nominal voltage U _N	300 V	300 V

GOST 

IECEE CB Scheme 

mm ² /AWG/kcmil	0.2-1.5
Nominal current I _N	8 A
Nominal voltage U _N	160 V

Printed-circuit board connector - FK-MCP 1,5/ 9-STF-3,81 - 1851300

Approvals



CCA	
mm ² /AWG/kcmil	0.2-1.5
Nominal current I _N	8 A
Nominal voltage U _N	160 V



Accessories

Accessories

Marking

Marker cards - SK 3,81/2,8:FORTL.ZAHLEN - 0804109



Marker cards, Card, white, labeled, Horizontal: Consecutive numbers 1 - 10, 11 - 20, etc. up to 91 - (99)100, Mounting type: Adhesive, For terminal block width: 3.81 mm

Tools

Phillips-screwdriver - SZS 0,4X2,5 VDE - 1205037



Screwdriver, slot-headed, VDE insulated, size: 0.4 x 2.5 x 80 mm, 2-component grip, with non-slip grip

Additional products

Printed-circuit board connector - FK-MCP 1,5/ 9-STF-3,81 - 1851300

Accessories

Base strip - DFK-MC 1,5/ 9-GF-3,81 - 1829400



Plug component, Nominal current: 8 A, Rated voltage (III/2): 160 V, Number of positions: 9, Pitch: 3.81 mm, Connection method: Solder/Slip-on connection, Color: green, Contact surface: Tin, Assembly: Direct mounting

Base strip - MCDV 1,5/ 9-G1F-3,81 - 1842830



Header, Nominal current: 8 A, Rated voltage (III/2): 160 V, Number of positions: 9, Pitch: 3.81 mm, Color: green, Contact surface: Tin, Assembly: Soldering, In combination with MCV plug components, both an MCVW and an MCVR plug must be used.

Base strip - MCDV 1,5/ 9-GF-3,81 - 1830321



Header, Nominal current: 8 A, Rated voltage (III/2): 160 V, Number of positions: 9, Pitch: 3.81 mm, Color: green, Contact surface: Tin, Assembly: Soldering, In combination with MCV plug components, both an MCVW and an MCVR plug must be used.

Base strip - MCD 1,5/ 9-GF-3,81 - 1830172



Header, Nominal current: 8 A, Rated voltage (III/2): 160 V, Number of positions: 9, Pitch: 3.81 mm, Color: green, Contact surface: Tin, Assembly: Soldering, In combination with MCV plug components, both an MCVW and an MCVR plug must be used.

Base strip - MCD 1,5/ 9-G1F-3,81 - 1842982

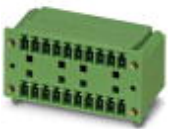

Header, Nominal current: 8 A, Rated voltage (III/2): 160 V, Number of positions: 9, Pitch: 3.81 mm, Color: green, Contact surface: Tin, Assembly: Soldering, In combination with MCV plug components, both an MCVW and an MCVR plug must be used.

Printed-circuit board connector - FK-MCP 1,5/ 9-STF-3,81 - 1851300

Accessories

Printed-circuit board connector - IMC 1,5/ 9-STGF-3,81 - 1858109

Plug component, Nominal current: 8 A, Rated voltage (III/2): 160 V, Number of positions: 9, Pitch: 3.81 mm, Connection method: Screw connection, Color: green, Contact surface: Tin



Base strip - MCVU 1,5/ 9-GFD-3,81 - 1833098



Plug component, Nominal current: 8 A, Rated voltage (III/2): 160 V, Number of positions: 9, Pitch: 3.81 mm, Connection method: Screw connection, Color: green, Contact surface: Tin, Assembly: Direct mounting

Base strip - MCVK 1,5/ 9-GF-3,81 - 1832947



Plug component, Nominal current: 8 A, Rated voltage (III/2): 160 V, Number of positions: 9, Pitch: 3.81 mm, Connection method: Screw connection, Color: green, Contact surface: Tin, Assembly: DIN rail

Base strip - MCV 1,5/ 9-GF-3,81 - 1830664



Header, Nominal current: 8 A, Rated voltage (III/2): 160 V, Number of positions: 9, Pitch: 3.81 mm, Color: green, Contact surface: Tin, Assembly: Soldering

Base strip - MC 1,5/ 9-GF-3,81 - 1827936

Header, Nominal current: 8 A, Rated voltage (III/2): 160 V, Number of positions: 9, Pitch: 3.81 mm, Color: green, Contact surface: Tin, Assembly: Soldering



Printed-circuit board connector - FK-MCP 1,5/ 9-STF-3,81 - 1851300

Accessories

Base strip - MC 1,5/ 9-GF-3,81 THT - 1909100

Header, Nominal current: 8 A, Rated voltage (III/2): 160 V, Number of positions: 9, Pitch: 3.81 mm, Color: Black, Contact surface: Tin, Assembly: SMD/THT/THR, User information and design recommendations for through hole reflow technology can be found under "Downloads"



Base strip - SMC 1,5/ 9-GF-3,81 - 1827499

Header, Nominal current: 8 A, Rated voltage (III/2): 160 V, Number of positions: 9, Pitch: 3.81 mm, Color: green, Contact surface: Tin, Assembly: Soldering



Base strip - EMCV 1,5/ 9-GF-3,81 - 1879353

Header, Nominal current: 8 A, Rated voltage (III/2): 160 V, Number of positions: 9, Pitch: 3.81 mm, Color: green, Contact surface: Tin, Assembly: Press-in



Base strip - EMC 1,5/ 9-GF-3,81 - 1897018

Header, Nominal current: 8 A, Rated voltage (III/2): 160 V, Number of positions: 9, Pitch: 3.81 mm, Color: green, Contact surface: Tin, Assembly: Press-in



Drawings

Printed-circuit board connector - FK-MCP 1,5/ 9-STF-3,81 - 1851300

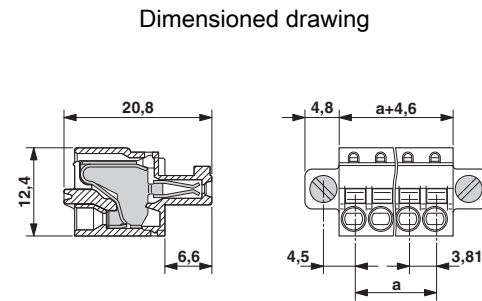
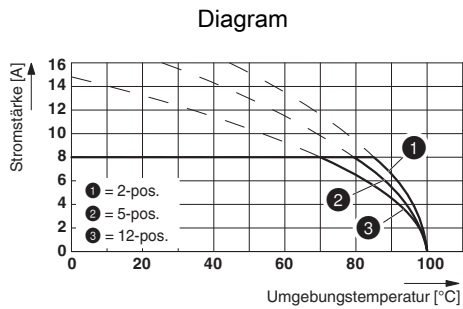

Type: FK-MCP 1,5/...-STF-3,81 with MC 1,5/...-GF-3,81 P.. THR

