



SPECIFICATIONS

CUSTOMER	:	_____
SAMPLE CODE	:	SH102600T009-IBC07
MASS PRODUCTION CODE	:	PH102600T009-IBC07
SAMPLE VERSION	:	01
SPECIFICATIONS EDITION	:	005
DRAWING NO. (Ver.)	:	LMD-PH102600T009-IBC07 (Ver.002)
PACKAGING NO. (Ver.)	:	PKG-PH102600T009-IBC07 (Ver.001)

Customer Approved

Date:

Approved	Checked	Designer
黃秋源 Oliver Huang	石建莊 Stone Shin	王聖硯 Stephen Wang

- Preliminary specification for design input
- Specification for sample approval

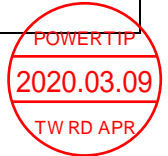

POWERTIP TECH. CORP.

Headquarters: No.8, 6 th Road, Taichung Industrial Park, Taichung, Taiwan 台中市 407 工業區六路 8 號	TEL: 886-4-2355-8168 FAX: 886-4-2355-8166	E-mail: sales@powertip.com.tw Http://www.powertip.com.tw
---	--	--

History of Version

Date	Ver.	Edi.	Description	Page	Design by
11/22/2017	01	001	New Drawing	-	Stephen
02/23/2018	01	002	New Sample	-	Stephen
03/20/2018	01	003	Modify Spec (Page 5,10)	-	Stephen
08/30/2019	01	004	Added 1.8 items	11	Stephen
03/04/2020	01	005	Modify Spec added module viewing direction for documentation Modify the content of the title 1.3	4、5	Stephen

Contents

1. SPECIFICATIONS

- 1.1 Features
- 1.2 Mechanical Specifications
- 1.3 Absolute Maximum Ratings
- 1.4 DC Electrical Characteristics
- 1.5 Optical Characteristics
- 1.6 Backlight Characteristics
- 1.7 Touch Panel Characteristics
- 1.8 HYCON I²C Sensitivity Command

2. MODULE STRUCTURE

- 2.1 Counter Drawing
- 2.2 Interface Pin Description
- 2.3 HDMI Characteristics

3. QUALITY ASSURANCE SYSTEM

- 3.1 Quality Assurance Flow Chart
- 3.2 Inspection Specification

4. RELIABILITY TEST

- 4.1 Reliability Test Condition

5. PRECAUTION RELATING PRODUCT HANDLING

- 5.1 Safety
- 5.2 Handling
- 5.3 Storage
- 5.4 Terms of Warranty

Appendix : LCM Drawing
LCM Packaging Specifications

1. SPECIFICATIONS

1.1 Features

Item	Standard Value
Display Resolution	1024 *3 (RGB) * 600 Dots
LCD Type	a-Si TFT , Normally White , Transmissive Type
Touch Panel	Projective Capacitive Touch Panel USB HID Touch
Screen Size(inch)	7.0 inch
Eyes Viewing Direction	12 O'clock
Grayscale Inversion Direction	6 O'clock
LCD Surface Treatment	Anti-Glare
Color Configuration	R.G.B. Vertical Stripe
Backlight Type	White LED B/L
Weight	199.1 g
Interface	HDMI
Controller/Driver IC	HYCON 4635
ROHS	THIS PRODUCT CONFORMS THE ROHS OF PTC Detail information please refer website : http://www.powertip.com.tw/news_detail.php?Key=1&clD=1

1.2 Mechanical Specifications

Item	Standard Value	Unit
Outline Dimension	164.9 (W) * 100.0 (L) * 15.7 (H)	mm

LCD panel

Item	Standard Value	Unit
Active Area	154.21 (W) * 85.92 (L)	mm

Note : For detailed information please refer to LCM drawing.

1.3 Absolute Maximum Ratings

Item	Symbol	Condition	Min.	Max.	Unit
Power Supply for Digital Circuit	V _{Bus}	GND=0V	-0.3	+6.0	V
Logic Supply Voltage	DVDD	-	-0.5	5	V
Analog Supply Voltage	AVDD	-	-0.5	15	V
Low Supply Voltage	VGL	-	-20	0.3	V
High Supply Voltage	VGH	-	-0.3	42	V
Operating Temperature	T _{OP} (Ts)	Note 1	-20	+70	°C
Storage Temperature	T _{ST} (Ta)	Note 2	-30	+80	°C

Note 1 : Ts is the temperature of panel's surface

Note 2 : Ta is the ambient temperature of samples

1.4 DC Electrical Characteristics

Module

GND = 0V, Ta = 25°C

Item	Symbol	Min.	Typ.	Max.	Unit	Remark
Input Signal Voltage	V _{Bus}	4.75	5.0	5.25	V	-
Supply Current	I _{VBus}	650	750	950	mA	Pattern = Full Display
Input Signal Voltage	V _{COM}	3.3	3.8	4.3	V	-
Logic Supply Voltage	DVDD	2.5	3.3	3.6	V	-
Analog Supply Voltage	AVDD	8.0	11.0	13.5	V	-
Low Supply Voltage	VGL	-7.1	-6.8	-6.5	V	-
High Supply Voltage	VGH	19.7	20.0	20.3	V	-
Logic Input Voltage	V _{IH}	0.7*DVDD	-	DVDD	V	-
	V _{IL}	GND	-	0.3*DVDD	V	-

Note1: The customer has to check the input current is greater than 1.5A.

Note2: Supply voltage which is included backlight drive.

Note3: Maximum current for RGB screen is 735~750mA (Full Display).

Note4: We use advised USB 2.0/3.0 Y-cable to power supply.

1.5 Optical Characteristics

TFT LCD Module

Ta=25°C

Item		Symbol	Condition	Min.	Typ.	Max.	unit	
Response Time	Rise	Tr	Ta = 25°C θX, θY = 0°	-	10	20	ms	Note 2
	Fall	Tf		-	15	30		
Viewing Angle	Top	θY+	CR ≥ 10	-	75	-	Deg.	Note 4
	Bottom	θY-		-	75	-		
	Left	θX-		-	75	-		
	Right	θX+		-	75	-		
Contrast Ratio		CR		500	800	-	-	Note 3
Color of CIE Coordinate (With B/L)	White	X	Ta = 25°C θX , θY = 0°	0.25	0.30	0.35	-	Note1
		Y		0.31	0.36	0.41		
	Red	X		0.60	0.65	0.70		
		Y		0.29	0.34	0.39		
	Green	X		0.27	0.32	0.37		
		Y		0.57	0.62	0.67		
	Blue	X		0.09	0.14	0.19		
		Y		0.01	0.06	0.11		
Average Brightness Pattern=White Display (With LCD) *1		IV	V _{Bus} =5.0V PWM="High" (Duty=100%)	300	350	-	cd/m ²	Note1
Uniformity (With LCD) *2		ΔB		70	-	-	%	Note1

Note1:

1 : $\Delta B = B(\min) / B(\max) \times 100\%$

2 : Measurement Condition for Optical Characteristics:

a : Environment: $25^{\circ}\text{C} \pm 5^{\circ}\text{C}$ / $60 \pm 20\% \text{R.H}$, no wind , dark room below 10 Lux at typical lamp current and typical operating frequency.

b : Measurement Distance: $500 \pm 50 \text{ mm}$, ($\theta = 0^{\circ}$)

c : Equipment: TOPCON BM-7 fast , (field 1°) , after 10 minutes operation.

d : The uncertainty of the C.I.E coordinate measurement ± 0.01 , Average Brightness $\pm 4\%$

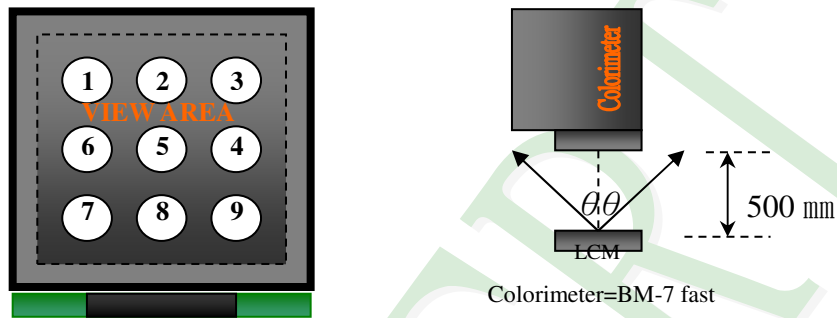

To be measured at the center area of panel with a viewing cone of 1° by Topcon luminance meter BM-7, after 10 minutes operation (module)

Note2: Definition of response time:

The output signals of photo detector are measured when the input signals are changed from "black" to "white"(falling time) and from "white" to "black"(rising time), respectively.

The response time is defined as the time interval between the 10% and 90% of Amplitudes.

Refer to figure as below:

Normally White



Normally Black

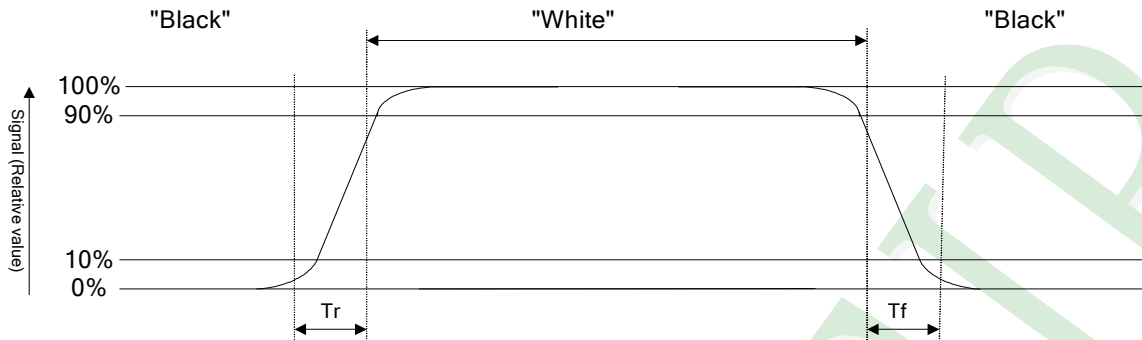

Note3: Definition of contrast ratio:

Contrast ratio is calculated with the following formula

$$\text{Contrast ratio (CR)} = \frac{\text{Photo detector output when LCD is at "White" state}}{\text{Photo detector output when LCD is at "Black" state}}$$

Note4: Definition of viewing angle:

Refer to figure as below:

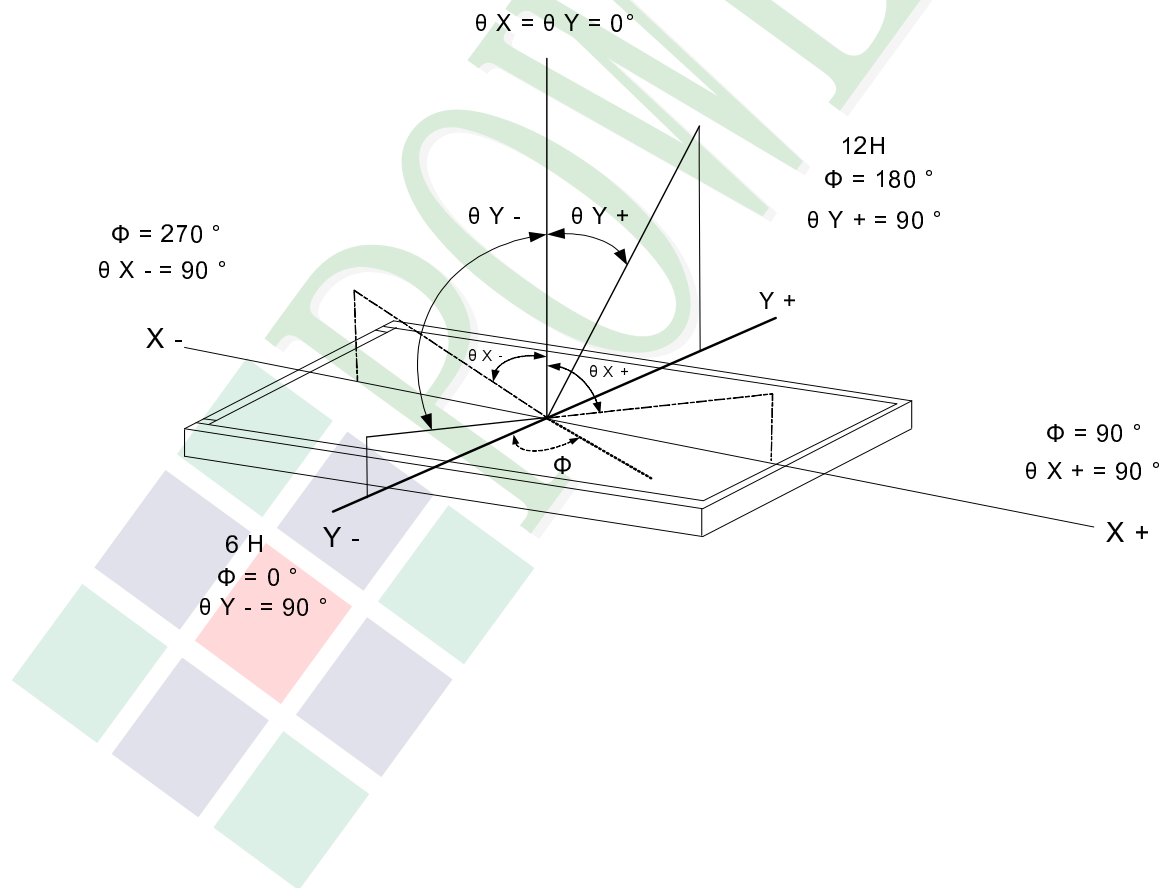

1.6 Backlight Characteristics

Maximum Ratings

Item	Symbol	Min.	Max.	Unit	Remark
LED Forward Current	I_F	20		mA	One LED
LED Reverse Voltage	V_R	5		V	

Electrical / Optical Characteristics

Item	Symbol	Condition	Min.	Typ.	Max.	Unit	Remark
LED Voltage	V_L	$I_L=200\text{mA}$	8.7	9.6	10.2	V	Note1
LED Life Time	-		20000	-	-	hr	Note2

Note 1: The LED Supply Voltage is defined by the number of LED at $T_a=25\text{ }^\circ\text{C}$.

Note 2: The "LED life time" is defined as the module brightness decrease to 50% original brightness at $T_a=25\text{ }^\circ\text{C}$ and $I_L=200\text{ mA}$. The LED life time could be decreased if operating I_L is larger than 200 mA.

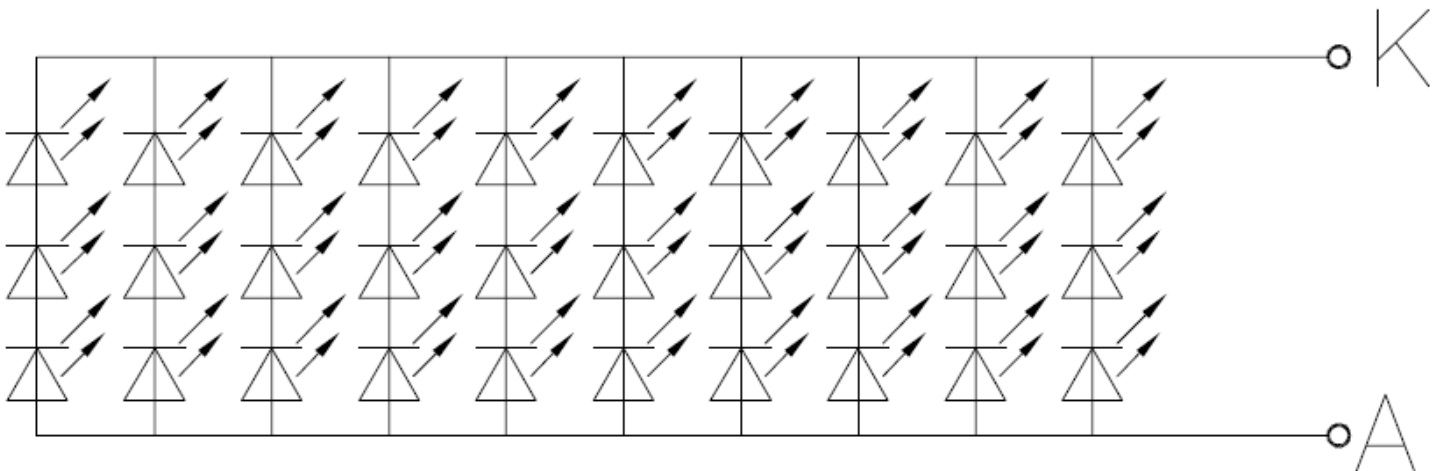

1.7 Touch Panel Characteristics

Features

Item	Standard Value
Touch Panel Size	7"
Touch Type	Projective Capacitive Touch Panel
Input Method	Finger / 5 Points Touch
Interface	I ² C
I ² C Address	0x38 (7-bit)

I²C Address

Bit 7	Bit 6	Bit 5	Bit 4	Bit 3	Bit 2	Bit 1	Bit 0
0	1	1	1	0	0	0	R/W

Bit 0: 0 for Write / 1 for Read

Mechanical Specifications

Item	Standard Value	Unit
Viewing Area	154.88 (W) * 86.72 (L)	mm
Number of Sensing Channel	14 * 24	

Absolute Maximum Ratings

Item	Symbol	Condition	Min.	Max.	Unit
Supply Voltage	TP_VDD	-	-0.3	+6.0	V
Operating Temperature	T _{OP}	-	-20	+70	°C
Storage Temperature	T _{ST}	-	-30	+80	°C
Storage Humidity	HD	T _a < 25 °C	-	90	%RH

DC Electrical Characteristics

Item	Symbol	Condition	Min.	Typ.	Max.	Unit
Power Supply Voltage	TP_VDD	-	2.8	3.3	3.6	V

Touch Panel IC Read/Write description & Register Mapping

Reference: HYCON Touch Driver Porting Reference Guide.

1.8 HYCON I²C Sensitivity command:

Address	Register description	R/W	Bit7	Bit6	Bit5	Bit4	Bit3	Bit2	Bit1	Bit0
0x92	GAIN	R/W	Sensitivity setting, setting range : 0--5							

Application reference:

Register 0x92=02(Default) without cover lens

Caution!

At different cover lens thickness can lead to touch Sensitivity changed (e.g. ghost-touches).

Therefore, the touch needs to be thoroughly tested in the target application.

PTC application design suggestion is only for reference, please adjust based on your final design.

2. MODULE STRUCTURE

2.1 Counter Drawing

2.1.1 LCM Mechanical Diagram

* See Appendix

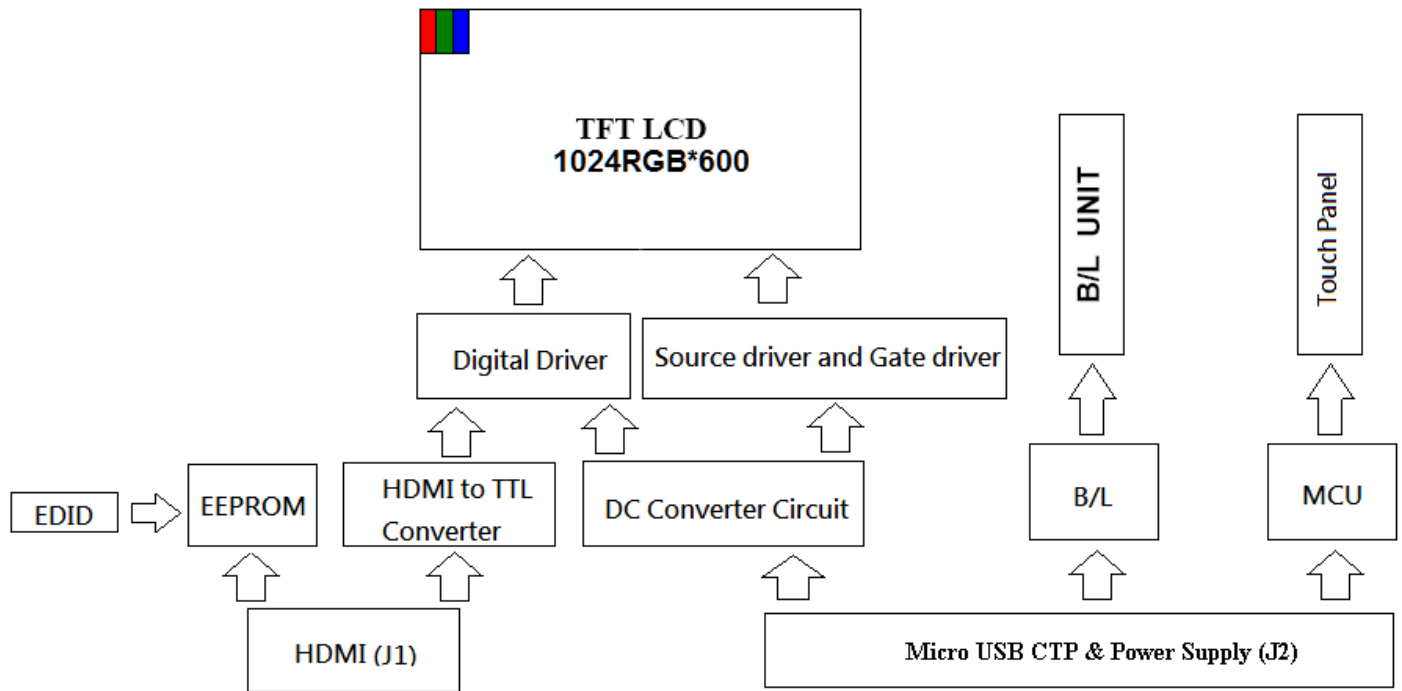

2.2 Interface Pin Description (CN1)

2.2.1 (J1: HDMI 1.3 A type Interface)

Pin#	Name	Description
1	TX2+	TMDS Data 2+
2	TX2 Shield	TMDS Data 2 Shield
3	TX2-	TMDS Data 2-
4	TX1+	TMDS Data 1+
5	TX1 Shield	TMDS Data 1 Shield
6	TX1-	TMDS Data 1-
7	TX0+	TMDS Data 0+
8	TX0 Shield	TMDS Data 0 Shield
9	TX0-	TMDS Data 0-
10	TXC+	TMDS Clock+
11	TXC Shield	TMDS Clock Shield
12	TXC-	TMDS Clock-
13	CEC	CEC
14	NC	No Connection
15	SCL	Serial Clock for DDC
16	SDA	Serial Data for DDC
17	GND	Power Ground
18	V5V	+5V Power
19	Hot Plug Detect	Hot Plug Detect

2.2.2 (J2: Micro USB Capacitive Touch Panel & Power Supply Interface)

Pin#	Name	Description
1	V _{Bus}	V _{Bus} 4.75V-5.25V
2	D-	Data-
3	D+	Data+
4	ID	No Connection
5	GND	Power Ground.

2.3 HDMI Characteristics

2.3.1 Signal DC&AC Characteristics

DC ELECTRICAL CHARACTERISTICS

over operating free-air temperature range (unless otherwise noted)

PARAMETER	TEST CONDITIONS	MIN	TYP	MAX	UNIT
V _{ID} Analog input differential voltage ⁽¹⁾		75		1200	mV
V _{IC} Analog input common-mode voltage ⁽¹⁾		AV _{DD} - 300		AV _{DD} - 37	mV
V _{I(OC)} Open-circuit analog input voltage		AV _{DD} - 10		AV _{DD} + 10	mV
I _{DD(2PIX)} Normal 2-pix/clock power supply current ⁽²⁾	ODCK = 82.5 MHz, 2-pix/clock			370	mA
I _{PD} Power-down current ⁽³⁾	\overline{PD} = low			10	mA
I _{PDO} Output drive power-down current ⁽³⁾	\overline{PDO} = low		35		mA

(1) Specified as dc characteristic with no overshoot or undershoot

(2) Alternating 2-pixel black/2-pixel white pattern. ST = high, STAG = high, QE[23:0] and QO[23:0] C_L = 10 pF.

(3) Analog inputs are open circuit (transmitter is disconnected from TFP401/401A).

AC ELECTRICAL CHARACTERISTICS

over recommended operating free-air temperature range (unless otherwise noted)

PARAMETER	TEST CONDITIONS	MIN	TYP	MAX	UNIT
V _{ID(2)} Differential input sensitivity ⁽¹⁾		150		1560	mV _{p-p}
t _{ps} Analog input intra-pair (+ to -) differential skew ⁽²⁾				0.4	t _{bit} ⁽³⁾
t _{ocs} Analog input inter-pair or channel-to-channel skew ⁽²⁾				1	t _{pix} ⁽⁴⁾
t _{jit} Worst-case differential input clock jitter tolerance ⁽²⁾⁽⁵⁾		50			ps
t _{f1} Fall time of data and control signals ⁽⁶⁾⁽⁷⁾	ST = low, C _L = 5 pF			2.4	ns
	ST = high, C _L = 10 pF			1.9	
t _{r1} Rise time of data and control signals ⁽⁶⁾⁽⁷⁾	ST = low, C _L = 5 pF			2.4	ns
	ST = high, C _L = 10 pF			1.9	
t _{r2} Rise time of ODCK clock ⁽⁶⁾	ST = low, C _L = 5 pF			2.4	ns
	ST = high, C _L = 10 pF			1.9	
t _{f2} Fall time of ODCK clock ⁽⁶⁾	ST = low, C _L = 5 pF			2.4	ns
	ST = high, C _L = 10 pF			1.9	
t _{su1} Setup time, data and control signal to falling edge of ODCK	1 pixel/clock, PIXS = low, OCK_INV = low	1.8			ns
	2 pixel/clock, PIXS = high, STAG = high, OCK_INV = low	3.8			
	2 pixel and STAG, PIXS = high, STAG = low, OCK_INV = low	0.7			
t _{h1} Hold time, data and control signal to falling edge of ODCK	1 pixel/clock, PIXS = low, OCK_INV = low	0.6			ns
	2 pixel and STAG, PIXS = high, STAG = low, OCK_INV = low	2.5			
	2 pixel/clock, PIXS = high, STAG = high, OCK_INV = low	2.9			

(1) Specified as ac parameter to include sensitivity to overshoot, undershoot and reflection.

(2) By characterization

(3) t_{bit} is 1/10 the pixel time, t_{pix}

(4) t_{pix} is the pixel time defined as the period of the Rx/C input clock. The period of ODCK is equal to t_{pix} in 1-pixel/clock mode or 2t_{pix} when in 2-pixel/clock mode.

(5) Measured differentially at 50% crossing using ODCK output clock as trigger

(6) Rise and fall times measured as time between 20% and 80% of signal amplitude.

(7) Data and control signals are QE[23:0], QO[23:0], DE, HSYNC, VSYNC. and CTL[3:1].

AC ELECTRICAL CHARACTERISTICS (continued)

over recommended operating free-air temperature range (unless otherwise noted)

PARAMETER		TEST CONDITIONS	MIN	TYP	MAX	UNIT
t_{su2}	Setup time, data and control signal to rising edge of ODCK	1 pixel/clock, PIXS = low, OCK_INV = high	2.1			ns
		2 pixel/clock, PIXS = high, STAG = high, OCK_INV = high	4			
		2 pixel and STAG, PIXS = high, STAG = low, OCK_INV = high	1.5			
t_{h2}	Hold time, data and control signal to rising edge of ODCK	1 pixel/clock, PIXS = low, OCK_INV = high	0.5			ns
		2 pixel and STAG, PIXS = high, STAG = low, OCK_INV = high	2.4			
		2 pixel/clock, PIXS = high, STAG = high, OCK_INV = high	2.1			
f_{ODCK}	ODCK frequency	PIX = low (1-PIX/CLK)	25		165	MHz
		PIX = high (2-PIX/CLK)	12.5		82.5	
	ODCK duty-cycle		40%	50%	60%	
$t_{pd(PDL)}$	Propagation delay time from \overline{PD} low to Hi-Z outputs				9	ns
$t_{pd(PDOL)}$	Propagation delay time from \overline{PDO} low to Hi-Z outputs				9	ns
$t_{t(HSC)}$	Transition time between DE transition to SCDT low ⁽⁸⁾			1e6		t_{pix}
$t_{t(FSC)}$	Transition time between DE transition to SCDT high ⁽⁸⁾			1600		t_{pix}
$t_{d(st)}$	Delay time, ODCK latching edge to QE[23:0] data output	\overline{STAG} = low, PIXS = high		0.25		t_{pix}

(8) Link active or inactive is determined by amount of time detected between DE transitions. SCDT indicates link activity.

2.3.2 Parameter Measurement Information

PARAMETER MEASUREMENT INFORMATION

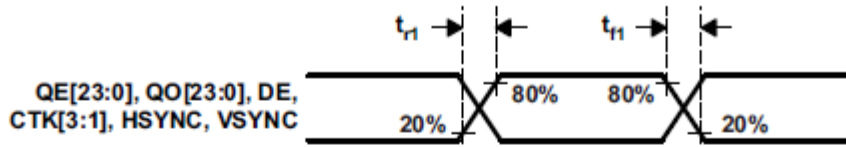

Figure 1. Rise and Fall Times of Data and Control Signals

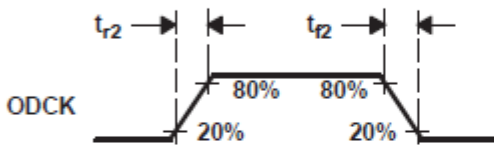

Figure 2. Rise and Fall Times of ODCK

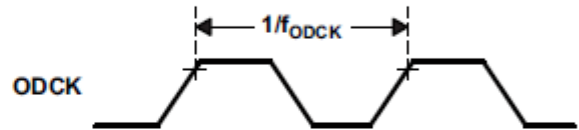

Figure 3. ODCK Frequency

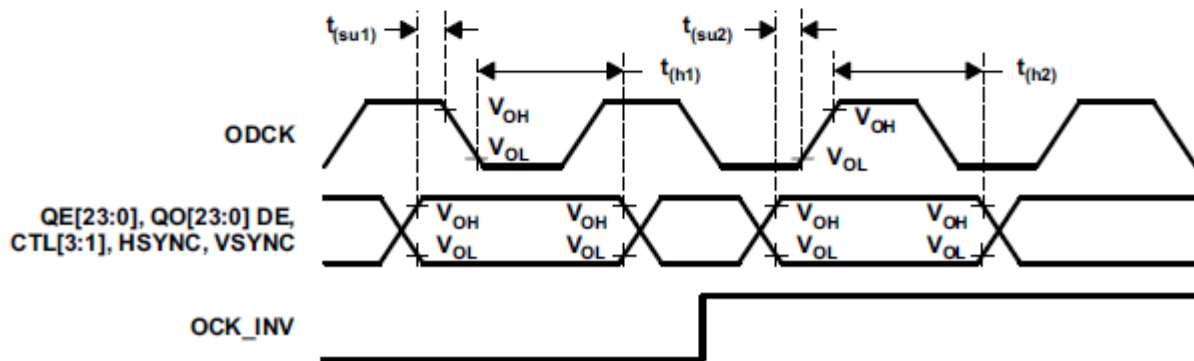

Figure 4. Data Setup and Hold Times to Rising and Falling Edges of ODCK

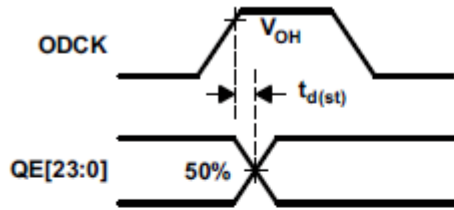

Figure 5. ODCK High to QE[23:0] Staggered Data Output

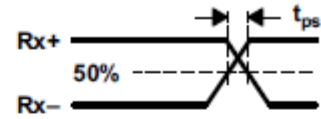

Figure 6. Analog Input Intra-Pair Differential Skew

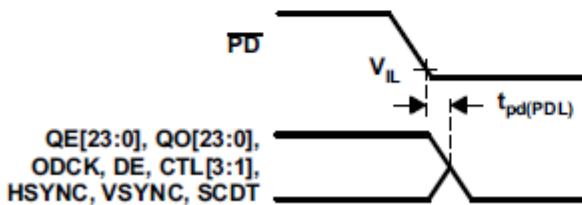

Figure 7. Delay From \overline{PD} Low to Hi-Z Outputs

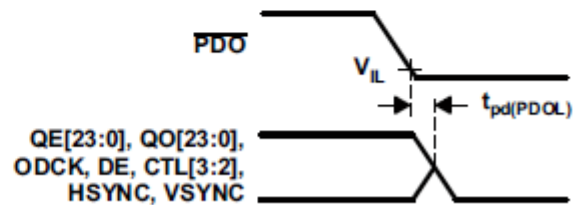

Figure 8. Delay From \overline{PDO} Low to Hi-Z Outputs

PARAMETER MEASUREMENT INFORMATION (continued)

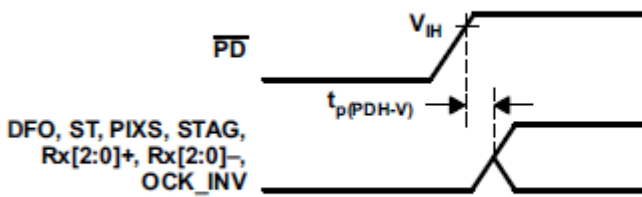

Figure 9. Delay From \overline{PD} Low to High Before Inputs Are Active

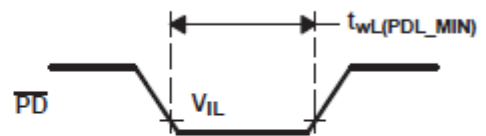

Figure 10. Minimum Time \overline{PD} Low

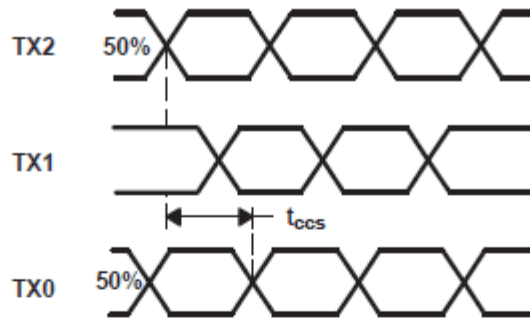

Figure 11. Analog Input Channel-to-Channel Skew

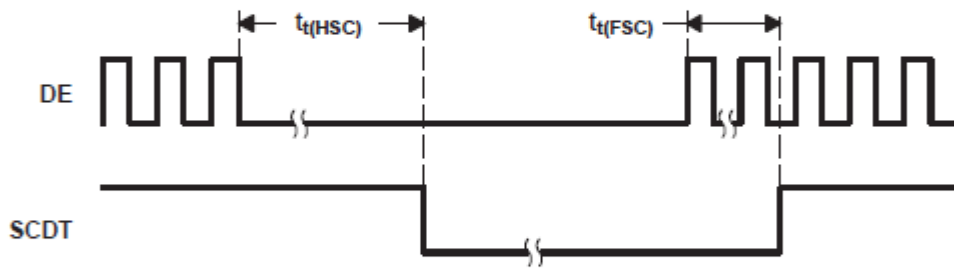

Figure 12. Time Between DE Transitions to SCDT Low and SCDT High

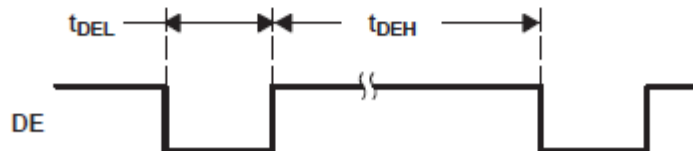
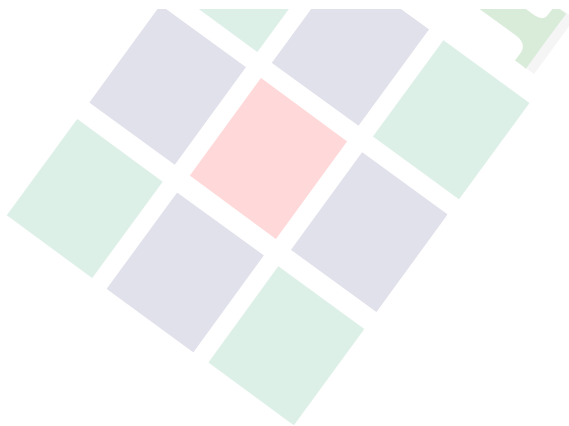

Figure 13. Minimum DE Low and Maximum DE High

DETAILED DESCRIPTION



3. QUALITY ASSURANCE SYSTEM

3.1 Quality Assurance Flow Chart

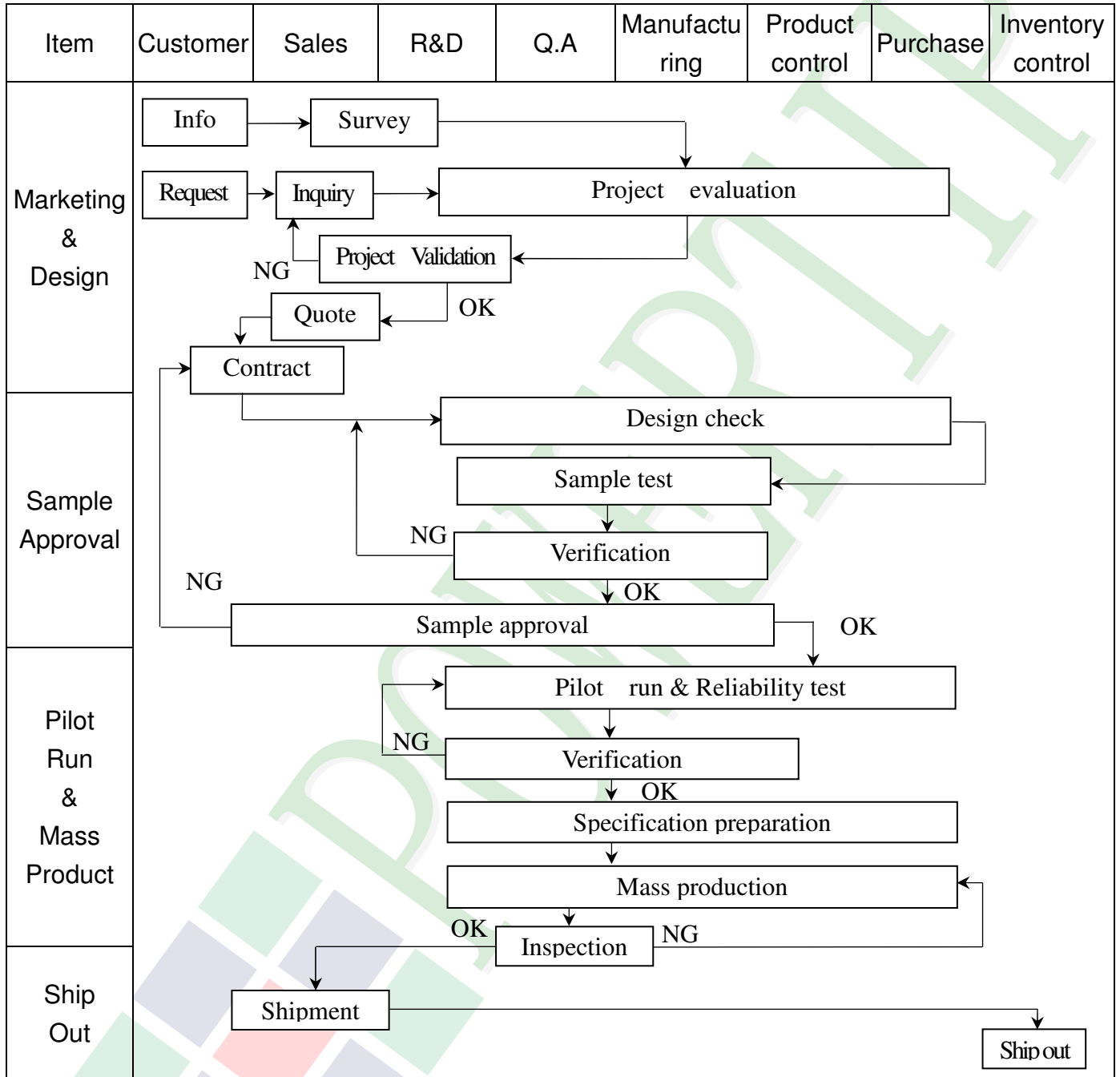

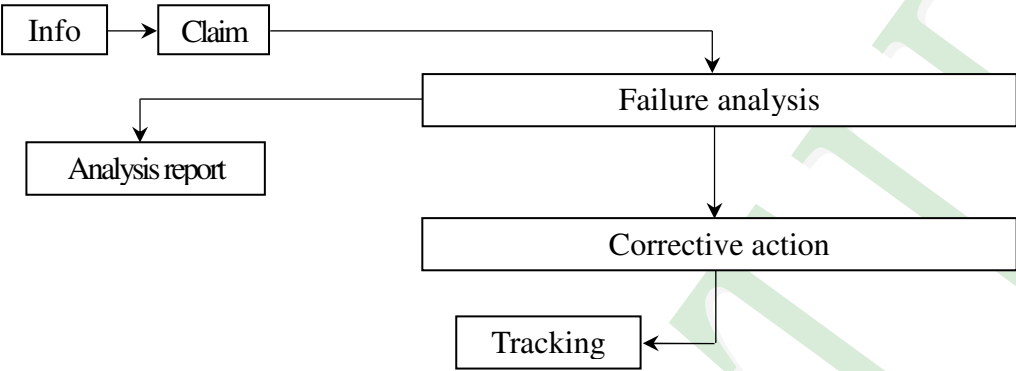
Item	Customer	Sales	R&D	Q.A	Manufacturing	Product control	Purchase	Inventory control
Sales Service	 <pre> graph TD Info[Info] --> Claim[Claim] Claim --> FA[Failure analysis] FA --> AR[Analysis report] FA --> CA[Corrective action] CA --> Tracking[Tracking] </pre>							
Q.A Activity	1. ISO 9001 Maintenance Activities 3. Equipment calibration 5. Standardization Management				2. Process improvement proposal 4. Education And Training Activities			

3.2. Inspection Specification

- ◆Scope: The document shall be applied to TFT-LCD Module for 3.5" ~15" (Ver.B01).
- ◆Inspection Standard: MIL-STD-105E Table Normal Inspection Single Sampling Level II.
- ◆Equipment: Gauge, MIL-STD, Powertip Tester, Sample
- ◆Defect Level: Major Defect AQL: 0.4; Minor Defect AQL: 1.5
- ◆OUT Going Defect Level: Sampling.
- ◆Standard of the product appearance test:

a. Manner of appearance test:

- (1). The test best be under 20W×2 fluorescent light(about 300lux ~500lux)
 , and distance of view must be at 30~40 cm.
- (2). The test direction is base on about around 45° of vertical line.

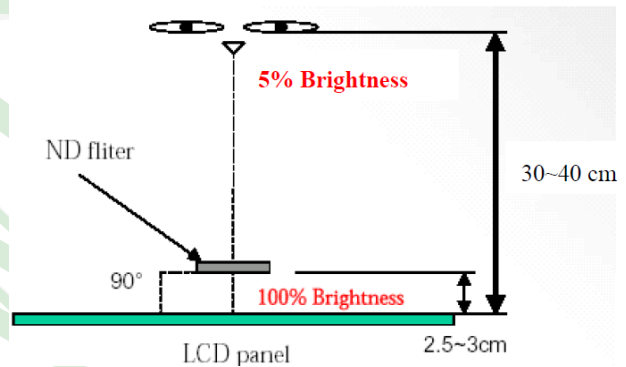
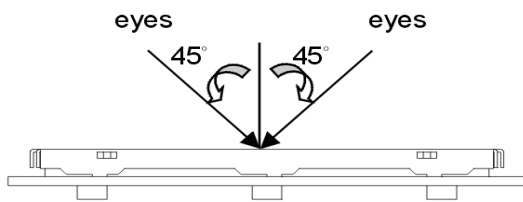

(3). Definition of area.

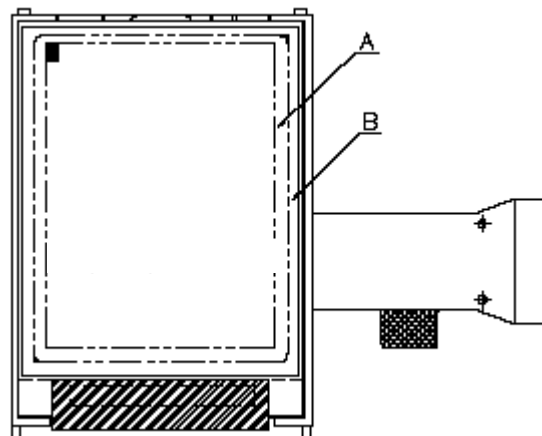

A area: viewing area

B area: Outside of viewing area

(4). Standard of inspection : (Unit : mm)

◆ Specification For TFT-LCD Module 3.5" ~15" :

(Ver.B01)

NO	Item	Criterion	Level												
01	Product condition	1. 1 The part number is inconsistent with work order of production.	Major												
		1. 2 Mixed product types.	Major												
		1. 3 Assembled in inverse direction.	Major												
02	Quantity	2. 1 The quantity is inconsistent with work order of production.	Major												
03	Outline dimension	3. 1 Product dimension and structure must conform to structure diagram.	Major												
04	Electrical Testing	4. 1 Missing line character and icon.	Major												
		4. 2 No function or no display.	Major												
		4. 3 Display malfunction.	Major												
		4. 4 LCD viewing angle defect.	Major												
		4. 5 Current consumption exceeds product specifications.	Major												
		4. 6 Mura cannot be seen through 5% ND filter at 50% Gray, should be judged by the viewing angle of 90 degree.	Minor												
05	Dot defect (Bright dot, Dark dot) On -display	<table border="1"> <thead> <tr> <th></th> <th>Item</th> <th>Acceptance (Q'ty)</th> </tr> </thead> <tbody> <tr> <td rowspan="4">Dot Defect</td> <td>Bright Dot</td> <td>≦ 4</td> </tr> <tr> <td>Dark Dot</td> <td>≦ 5</td> </tr> <tr> <td>Joint Dot</td> <td>≦ 3</td> </tr> <tr> <td>Total</td> <td>≦ 7</td> </tr> </tbody> </table>		Item	Acceptance (Q'ty)	Dot Defect	Bright Dot	≦ 4	Dark Dot	≦ 5	Joint Dot	≦ 3	Total	≦ 7	Minor
			Item	Acceptance (Q'ty)											
		Dot Defect	Bright Dot	≦ 4											
			Dark Dot	≦ 5											
			Joint Dot	≦ 3											
Total	≦ 7														
5. 1 Inspection pattern: full white, full black, Red, Green and blue screens.															
5. 2 It is defined as dot defect if defect area > 1/2 dot.															
5. 3 The distance between two dot defect ≧ 5 mm.															
5. 4 Bright dot that can not be seen through 5% ND filter.															

◆ Specification For TFT-LCD Module 3.5" ~15" :

(Ver.B01)

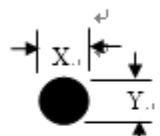
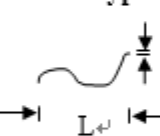
NO	Item	Criterion	Level																																																							
06	<p>Black or white Dot, scratch, contamination</p> <p>Round type</p>  <p>$\Phi = (x + y) / 2$</p> <p>Line type</p> 	<p>6.1 Round type (Non-display or display):</p> <table border="1"> <thead> <tr> <th rowspan="2">Dimension (diameter : Φ)</th> <th colspan="2">Acceptance (Q'ty)</th> </tr> <tr> <th>A area</th> <th>B area</th> </tr> </thead> <tbody> <tr> <td>$\Phi \leq 0.25$</td> <td>Ignore</td> <td rowspan="4">Ignore</td> </tr> <tr> <td>$0.25 < \Phi \leq 0.50$</td> <td>5</td> </tr> <tr> <td>$\Phi > 0.50$</td> <td>0</td> </tr> <tr> <td>Total</td> <td>5</td> </tr> </tbody> </table> <p>6.2 Line type(Non-display or display):</p> <table border="1"> <thead> <tr> <th rowspan="2">module size</th> <th rowspan="2">Length (L)</th> <th rowspan="2">Width (W)</th> <th colspan="2">Acceptance (Q'ty)</th> </tr> <tr> <th>A area</th> <th>B area</th> </tr> </thead> <tbody> <tr> <td rowspan="4">3.5" to less 9"</td> <td>---</td> <td>$W \leq 0.03$</td> <td>Ignore</td> <td rowspan="4">Ignore</td> </tr> <tr> <td>$L \leq 10.0$</td> <td>$0.03 < W \leq 0.05$</td> <td>4</td> </tr> <tr> <td>$L \leq 5.0$</td> <td>$0.05 < W \leq 0.10$</td> <td>2</td> </tr> <tr> <td>---</td> <td>$W > 0.10$</td> <td>As round type</td> </tr> <tr> <td colspan="3">Total</td> <td>5</td> <td></td> </tr> <tr> <td rowspan="4">9" to 15"</td> <td>---</td> <td>$W \leq 0.05$</td> <td>Ignore</td> <td rowspan="4">Ignore</td> </tr> <tr> <td>$L \leq 10.0$</td> <td>$0.05 < W \leq 0.10$</td> <td>5</td> </tr> <tr> <td>---</td> <td>$W > 0.10$</td> <td>As round type</td> </tr> <tr> <td colspan="3">Total</td> <td>5</td> </tr> </tbody> </table>	Dimension (diameter : Φ)	Acceptance (Q'ty)		A area	B area	$\Phi \leq 0.25$	Ignore	Ignore	$0.25 < \Phi \leq 0.50$	5	$\Phi > 0.50$	0	Total	5	module size	Length (L)	Width (W)	Acceptance (Q'ty)		A area	B area	3.5" to less 9"	---	$W \leq 0.03$	Ignore	Ignore	$L \leq 10.0$	$0.03 < W \leq 0.05$	4	$L \leq 5.0$	$0.05 < W \leq 0.10$	2	---	$W > 0.10$	As round type	Total			5		9" to 15"	---	$W \leq 0.05$	Ignore	Ignore	$L \leq 10.0$	$0.05 < W \leq 0.10$	5	---	$W > 0.10$	As round type	Total			5	Minor
Dimension (diameter : Φ)	Acceptance (Q'ty)																																																									
	A area	B area																																																								
$\Phi \leq 0.25$	Ignore	Ignore																																																								
$0.25 < \Phi \leq 0.50$	5																																																									
$\Phi > 0.50$	0																																																									
Total	5																																																									
module size	Length (L)	Width (W)	Acceptance (Q'ty)																																																							
			A area	B area																																																						
3.5" to less 9"	---	$W \leq 0.03$	Ignore	Ignore																																																						
	$L \leq 10.0$	$0.03 < W \leq 0.05$	4																																																							
	$L \leq 5.0$	$0.05 < W \leq 0.10$	2																																																							
	---	$W > 0.10$	As round type																																																							
Total			5																																																							
9" to 15"	---	$W \leq 0.05$	Ignore	Ignore																																																						
	$L \leq 10.0$	$0.05 < W \leq 0.10$	5																																																							
	---	$W > 0.10$	As round type																																																							
	Total				5																																																					
07	Polarizer Bubble	<table border="1"> <thead> <tr> <th rowspan="2">Dimension (diameter: Φ)</th> <th colspan="2">Acceptance (Q'ty)</th> </tr> <tr> <th>A area</th> <th>B area</th> </tr> </thead> <tbody> <tr> <td>$\Phi \leq 0.25$</td> <td>Ignore</td> <td rowspan="5">Ignore</td> </tr> <tr> <td>$0.25 < \Phi \leq 0.50$</td> <td>4</td> </tr> <tr> <td>$0.50 < \Phi \leq 0.80$</td> <td>1</td> </tr> <tr> <td>$\Phi > 0.80$</td> <td>0</td> </tr> <tr> <td>Total</td> <td>5</td> </tr> </tbody> </table>	Dimension (diameter: Φ)	Acceptance (Q'ty)		A area	B area	$\Phi \leq 0.25$	Ignore	Ignore	$0.25 < \Phi \leq 0.50$	4	$0.50 < \Phi \leq 0.80$	1	$\Phi > 0.80$	0	Total	5	Minor																																							
Dimension (diameter: Φ)	Acceptance (Q'ty)																																																									
	A area	B area																																																								
$\Phi \leq 0.25$	Ignore	Ignore																																																								
$0.25 < \Phi \leq 0.50$	4																																																									
$0.50 < \Phi \leq 0.80$	1																																																									
$\Phi > 0.80$	0																																																									
Total	5																																																									

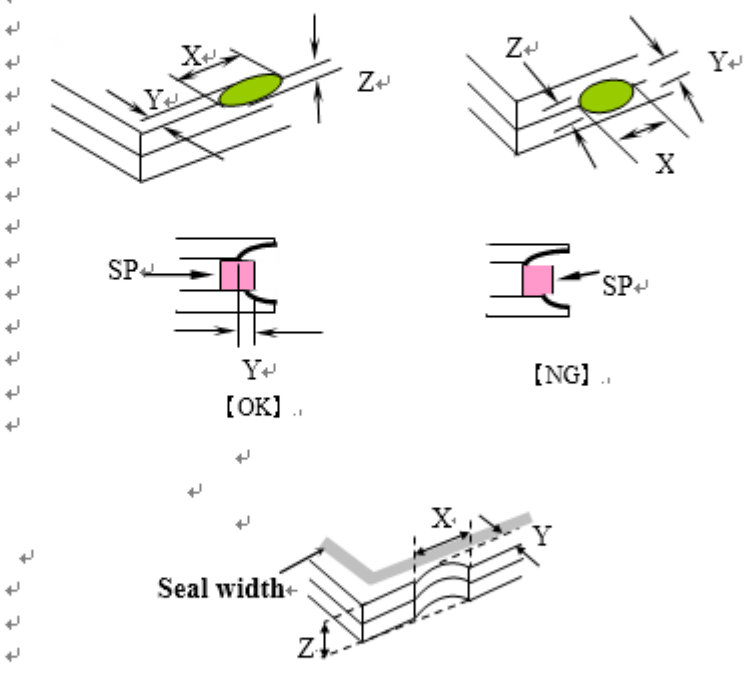
NO	Item	Criterion	Level									
08	The crack of glass	<p>Symbols :</p> <p>X: The length of crack Y: The width of crack Z: The thickness of crack W: terminal length t: The thickness of glass a: LCD side length</p> <hr/> <p>8.1 General glass chip:</p> <p>8.1.1 Chip on panel surface and crack between panels:</p>  <table border="1" data-bbox="566 1444 1292 1713"> <thead> <tr> <th>X</th> <th>Y</th> <th>Z</th> </tr> </thead> <tbody> <tr> <td>$\leq a$</td> <td>Crack can't enter viewing area</td> <td>$\leq 1/2 t$</td> </tr> <tr> <td>$\leq a$</td> <td>Crack can't exceed the half of SP width.</td> <td>$1/2 t < Z \leq t$</td> </tr> </tbody> </table>	X	Y	Z	$\leq a$	Crack can't enter viewing area	$\leq 1/2 t$	$\leq a$	Crack can't exceed the half of SP width.	$1/2 t < Z \leq t$	Minor
X	Y	Z										
$\leq a$	Crack can't enter viewing area	$\leq 1/2 t$										
$\leq a$	Crack can't exceed the half of SP width.	$1/2 t < Z \leq t$										

◆ Specification For TFT-LCD Module 3.5" ~15" :

(Ver.B01)

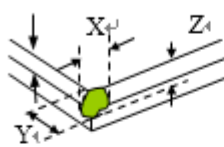
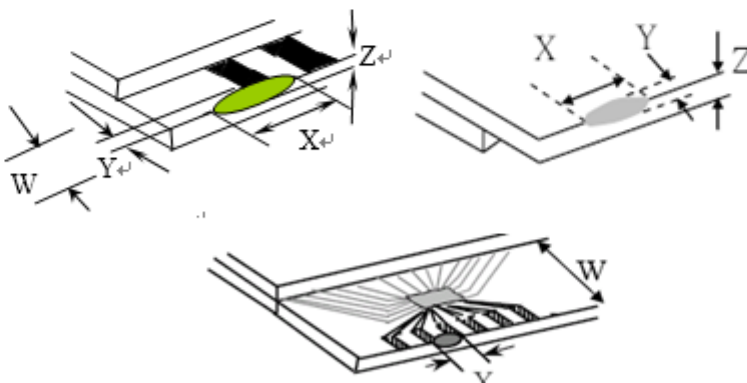
NO	Item	Criterion	Level												
08	The crack of glass	<p>Symbols :</p> <p>X: The length of crack Y: The width of crack. Z: The thickness of crack W: terminal length t: The thickness of glass a: LCD side length</p> <hr/> <p>8.1.2 Corner crack:</p>  <table border="1" data-bbox="555 721 1284 981"> <thead> <tr> <th>X</th> <th>Y</th> <th>Z</th> </tr> </thead> <tbody> <tr> <td>$\leq 1/5 a$</td> <td>Crack can't enter viewing area</td> <td>$Z \leq 1/2 t$</td> </tr> <tr> <td>$\leq 1/5 a$</td> <td>Crack can't exceed the half of SP width.</td> <td>$1/2 t < Z \leq 2 t$</td> </tr> </tbody> </table>	X	Y	Z	$\leq 1/5 a$	Crack can't enter viewing area	$Z \leq 1/2 t$	$\leq 1/5 a$	Crack can't exceed the half of SP width.	$1/2 t < Z \leq 2 t$	Minor			
X	Y	Z													
$\leq 1/5 a$	Crack can't enter viewing area	$Z \leq 1/2 t$													
$\leq 1/5 a$	Crack can't exceed the half of SP width.	$1/2 t < Z \leq 2 t$													
		<p>8.2 Protrusion over terminal:</p> <p>8.2.1 Chip on electrode pad:</p>  <table border="1" data-bbox="587 1556 1292 1713"> <thead> <tr> <th></th> <th>X</th> <th>Y</th> <th>Z</th> </tr> </thead> <tbody> <tr> <td>Front</td> <td>$\leq a$</td> <td>$\leq 1/2 W$</td> <td>$\leq t$</td> </tr> <tr> <td>Back</td> <td>$\leq a$</td> <td>$\leq W$</td> <td>$\leq 1/2 t$</td> </tr> </tbody> </table>		X	Y	Z	Front	$\leq a$	$\leq 1/2 W$	$\leq t$	Back	$\leq a$	$\leq W$	$\leq 1/2 t$	Minor
	X	Y	Z												
Front	$\leq a$	$\leq 1/2 W$	$\leq t$												
Back	$\leq a$	$\leq W$	$\leq 1/2 t$												

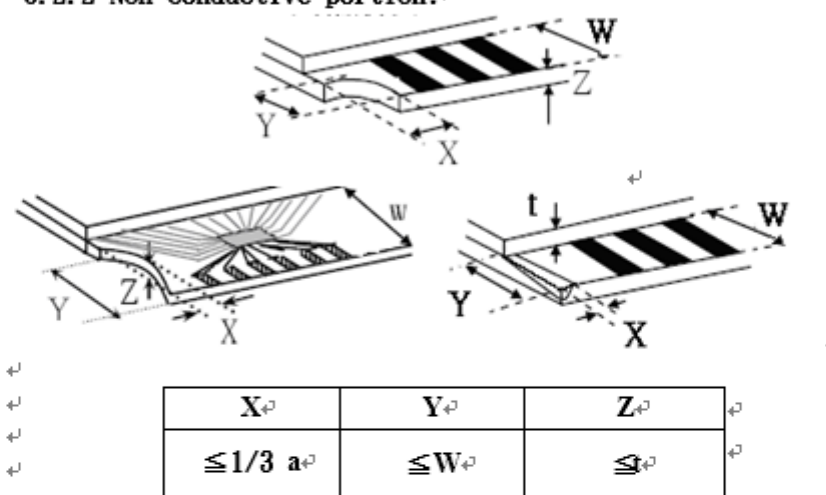
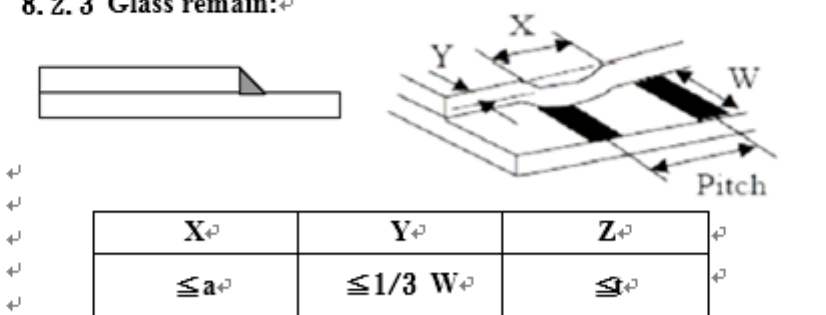
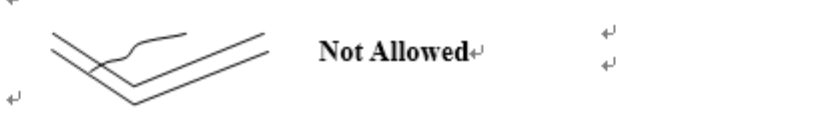
NO	Item	Criterion	Level
08	The crack of glass	<p>Symbols:</p> <p>X: The length of crack Y: The width of crack</p> <p>Z: The thickness of crack W: terminal length</p> <p>t: The thickness of glass a: LCD side length</p> <hr/> <p>8.2.2 Non-conductive portion:</p>  <p>8.2.3 Glass remain:</p>  <p>8.2.4 Cracking:</p> 	Minor

◆ Specification For TFT-LCD Module 3.5" ~15" :

(Ver.B01)

NO	Item	Criterion	Level
09	Backlight elements	9. 1 Backlight can't work normally.	Major
		9. 2 Backlight doesn't light or color is wrong.	Major
		9. 3 Illumination source flickers when lit.	Major
10	General appearance	10. 1 Pin type 、 quantity 、 dimension must match type in structure diagram.	Major
		10. 2 No short circuits in components on PCB or FPC.	Major
		10. 3 Parts on PCB or FPC must be: no wrong parts, missing parts or excess parts.	Major
		10. 4 Product packaging must the same as specified on packaging specification sheet.	Minor
		10. 5 The folding and peeled off in polarizer are not acceptable.	Minor
		10. 6 The PCB or FPC between B/L assembled distance(PCB or FPC) is ≤ 1.5 mm.	Minor

4. RELIABILITY TEST

4.1 Reliability Test Condition

(Ver.B01)

NO.	TEST ITEM	TEST CONDITION											
1	High Temperature Storage Test	Keep in +80 ±5°C 240 hrs											
2	Low Temperature Storage Test	Keep in -30 ±5°C 240 hrs											
3	High Temperature / High Humidity Storage Test	Keep in +60 °C / 90% R.H duration for 240 hrs (Excluding the polarizer)											
4	Temperature Cycling Storage Test	$\begin{array}{cccc} -30^{\circ}\text{C} & \rightarrow & +25^{\circ}\text{C} & \rightarrow & +80^{\circ}\text{C} & \rightarrow & +25^{\circ}\text{C} \\ (30\text{mins}) & & (5\text{mins}) & & (30\text{mins}) & & (5\text{mins}) \\ \leftarrow & & & & & & \rightarrow \\ & & & & \text{20 Cycle} & & \end{array}$											
5	ESD Test	Air Discharge: Apply 2 KV with 5 times Discharge for each polarity +/-	Contact Discharge: Apply 250 V with 5 times discharge for each polarity +/-										
		1. Temperature ambience : 15°C ~ 35°C 2. Humidity relative : 30% ~ 60% 3. Energy Storage Capacitance (Cs+Cd) : 150pF±10% 4. Discharge Resistance (Rd) : 330Ω±10% 5. Discharge, mode of operation : Single Discharge (time between successive discharges at least 1 sec) (Tolerance if the output voltage indication : ±5%)											
6	Vibration Test (Packaged)	1. Sine wave 10~55 Hz frequency (1 min/sweep) 2. The amplitude of vibration : 1.5 mm 3. Each direction (X、Y、Z) duration for 2 Hrs											
7	Drop Test (Packaged)	<table border="1"> <thead> <tr> <th>Packing Weight (Kg)</th> <th>Drop Height (cm)</th> </tr> </thead> <tbody> <tr> <td>0 ~ 45.4</td> <td>122</td> </tr> <tr> <td>45.4 ~ 90.8</td> <td>76</td> </tr> <tr> <td>90.8 ~ 454</td> <td>61</td> </tr> <tr> <td>Over 454</td> <td>46</td> </tr> </tbody> </table>		Packing Weight (Kg)	Drop Height (cm)	0 ~ 45.4	122	45.4 ~ 90.8	76	90.8 ~ 454	61	Over 454	46
		Packing Weight (Kg)	Drop Height (cm)										
0 ~ 45.4	122												
45.4 ~ 90.8	76												
90.8 ~ 454	61												
Over 454	46												
		Drop Direction : ※1 corner / 3 edges / 6 sides each 1time											

◎Result Evaluation Criteria :

Under the display quality test conditions with normal operations with normal operation state. Do not change these conditions as such changes may affect practical display function.

(Normal operation state)

Temperature: +20~30°C

Humidity: 50~70%

Atmospheric pressure: 86~106Kpa

5. PRECAUTION RELATING PRODUCT HANDLING

5.1 SAFETY

- 5.1.1 If the LCD panel breaks, be careful not to get the liquid crystal to touch your skin.
- 5.1.2 If the liquid crystal touches your skin or clothes, please wash it off immediately by using soap and water.

5.2 HANDLING

- 5.2.1 Avoid any strong mechanical shock which can break the glass.
- 5.2.2 Avoid static electricity which can damage the CMOS LSI—When working with the module, be sure to ground your body and any electrical equipment you may be using.
- 5.2.3 Do not remove the panel or frame from the module.
- 5.2.4 The polarizing plate of the display is very fragile. So, please handle it very carefully, do not touch, push or rub the exposed polarizing with anything harder than an HB pencil lead (glass, tweezers, etc.)
- 5.2.5 Do not wipe the polarizing plate with a dry cloth, as it may easily scratch the surface of plate.
- 5.2.6 Do not touch the display area with bare hands, this will stain the display area.
- 5.2.7 Do not use ketonics solvent & aromatic solvent. Use with a soft cloth soaked with a cleaning naphtha solvent.
- 5.2.8 To control temperature and time of soldering is $320 \pm 10^{\circ}\text{C}$ and 3-5 sec.
- 5.2.9 To avoid liquid (include organic solvent) stained on LCM
- 5.2.10 Caution!(LCM products with Capacitive Touch Panel)
Strong EMI-sources such as switch-mode power supplies (SMPS) can lead to touch malfunction (e.g. ghost-touches).
Therefore, the touch needs to be thoroughly tested inside the target application.
- 5.2.11 CAUTION: Continuously displaying same static image will result in high possibility of image sticking/image burn-in effect due to TFT panel characteristic.

5.3 STORAGE

- 5.3.1 Store the panel or module in a dark place where the temperature is $25^{\circ}\text{C} \pm 5^{\circ}\text{C}$ and the humidity is below 65% RH.
- 5.3.2 Do not place the module near organics solvents or corrosive gases.
- 5.3.3 Do not crush, shake, or jolt the module.

5.4 TERMS OF WARRANTY

- 5.4.1 Applicable warrant period The period is within thirteen months since the date of shipping out under normal using and storage conditions.
- 5.4.2 Unaccepted responsibility
This product has been manufactured to your company's specification as a part for use in your company's general electronic products. It is guaranteed to perform according to delivery specifications. For any other use apart from general electronic equipment, we cannot take responsibility if the product is used in nuclear power control equipment, aerospace equipment, fire and security systems or any other applications in which there is a direct risk to human life and where extremely high levels of reliability are required.

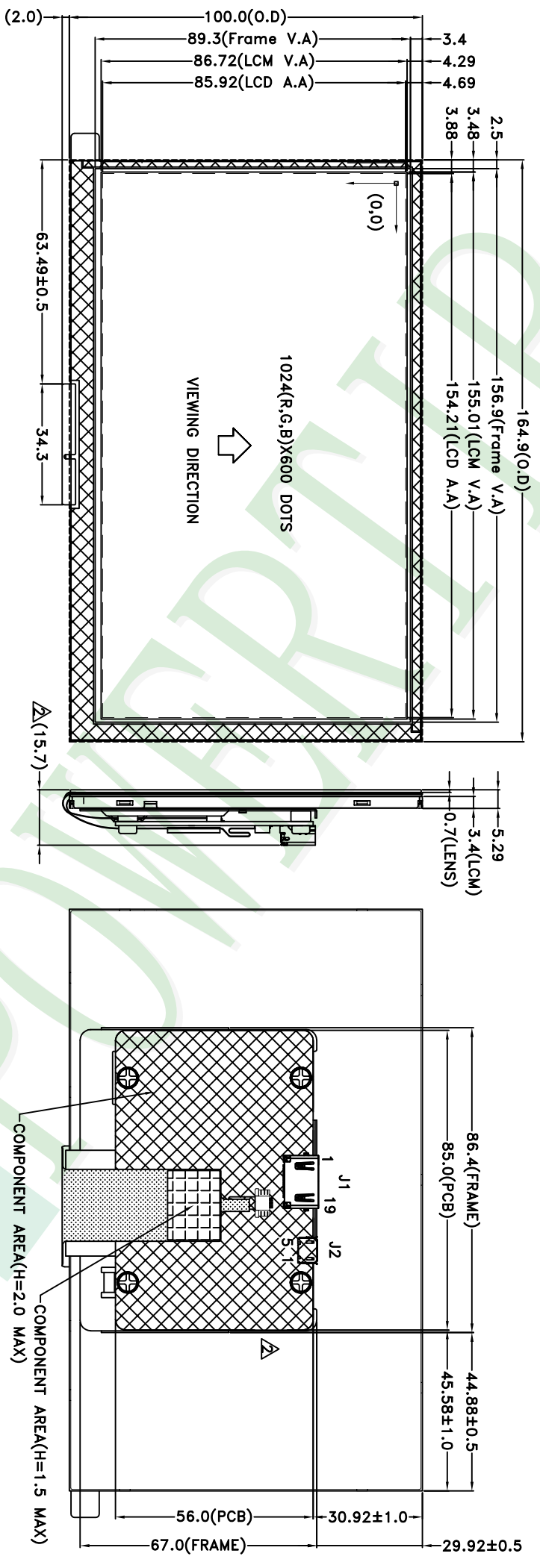

- NOTES:
- 1.LCD TYPE: TFT LCD
 - 2.LCD DISPLAY: POSITIVE/TRANSMISSIVE
 - 3.THE TOLERANCE UNLESS CLASSIFIED ±0.3mm
 - 4.J1 :ETC-HMAR51610U019S-3440N-7RM4-GP OR EQUIVALENT.
 - 5.J2 :ETC-MUSR231F205-GT117266S-RH OR EQUIVALENT.

007																					
006																					
005																					
004																					
003																					
002	CANCEL DC JACK			Stone				Stone		2018/01/25											
001	NEW DRAWING			Stone				Stone		2017/11/14											
REV		REV BY		REVISER				DATE													
PART NO: PH102600T009-IBC07										DRAWING NAME: LMD-PH102600T009-IBC07											
TITLE: LCD MODULE DRAWING																					
Design		Stone		Surface		Unit		Material		Precision Level		Tolerance (mm)		Length (mm)		Width (mm)		Thickness (mm)		Quantity	
Check		Oliver		MM		1:1				1 ~ 4		4 ~ 16		16 ~ 63		63 ~ 250					
Approve		Oliver		Page		1/1		Quantity													

久正光电股份有限公司
POWER TIP TECHNOLOGY CORPORATION

LCM包裝規格書

LCM Packaging Specifications

Approve

Check

Contact

Oliver

Oliver

Stone

1. 包裝材料規格表 (Packaging Material) : (per carton)

No.	Item	Model	Dimensions (mm)	1Pcs Weight	Quantity	Total Weight
1	成品 (LCM)	PH102600T009-IBC07	164.9 X 100.0	0.1991	20	3.982
2	抗靜電氣泡袋(1)Bubble Bag	BAG200160BRABA	200 X 160	0.0096	20	0.192
3	A6隔板(2)A6 Partition	BX33800012BZBA	338 X 125 X 3	0.038	22	0.836
4	B6-1隔板(3)B6-1 Partition	BX00000000056	298 X 125 X 3	0.023	4	0.092
5	海綿墊(4)Foam Rubber Cushion	OTFOAM00005ABA	330 X 290 X 10	0.025	4	0.1
6	舒美墊(5)EPE	OTFOAMT0006ABA	218 X 125 X 20	0.012	4	0.048
7	C4內盒(6)Product Box	BX36031014AABA	360 X 310 X 142	0.406	2	0.812
8	外紙箱(7)Carton	BX39432432CCBA	394 X 324 X 321	0.884	1	0.884
9						

2. 一整箱總重量 (Total LCD Weight in carton) : 6.95 Kg±10%

3. 單箱數量規格表 (Packaging Specifications and Quantity) :

(1) Quantity Of Spacer : A6隔板 X 11 , B6-1隔板 X 2

(2) Total LCM quantity in carton : quantity per box 10 x no of boxes 2 = 20

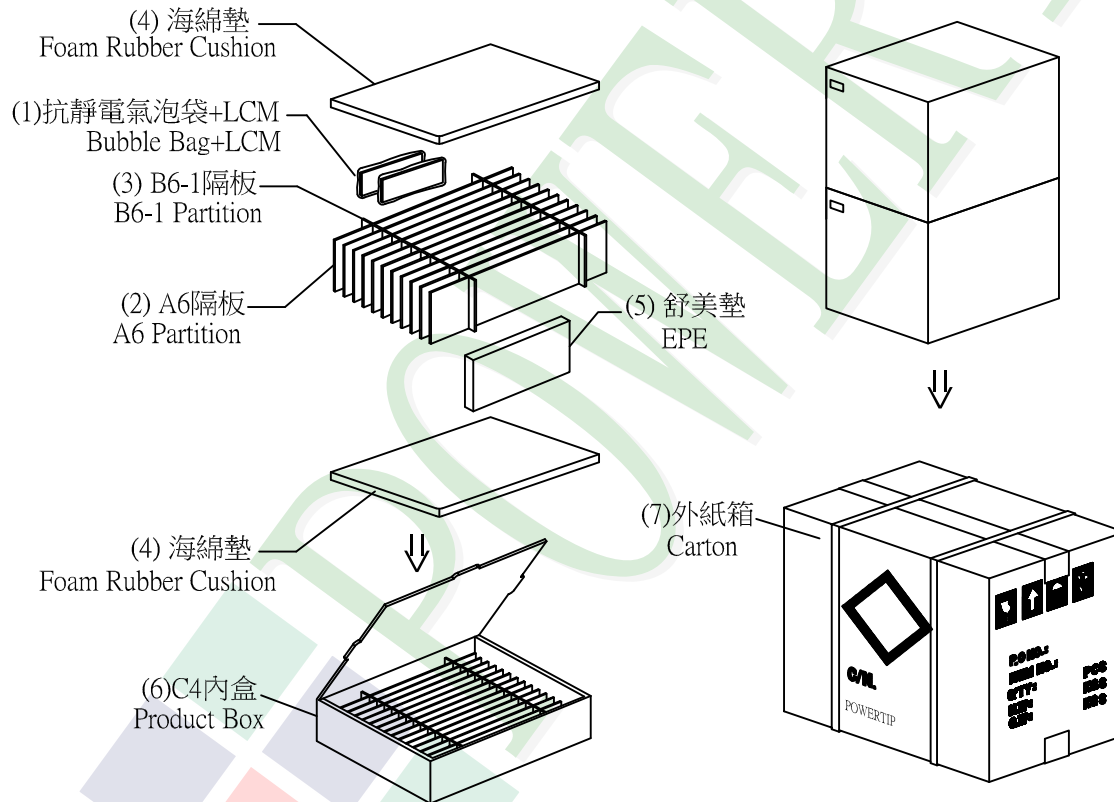

特記事項 (REMARK)

4. 每個間隔放1片模組，前後間隔不放置模組。(如示意圖)

4. 1 LCM are placed on every other slot of the divider.

Note: First and last slot should be empty.
(See remarks 6 on packaging specifications)

5. 放置格示意圖:

5. Each divider is placed inside a product Box

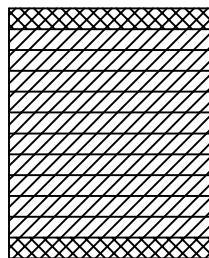

▨ 模組(LCM) X 1pcs.

▩ 舒美墊(EPE)