

REVISIONS					
REV	ECO	DESCRIPTION	DATE	BY	APPR
A1	-	RELEASE DRAWING	03MAY18	RIMON	TOMMY
A2	-	UPDATE NOTES	19FEB19	SULLEN	TOMMY

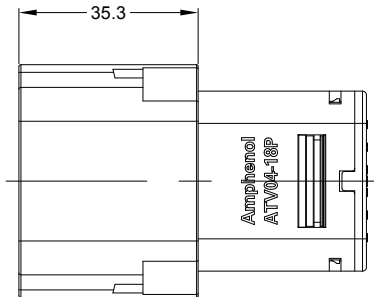
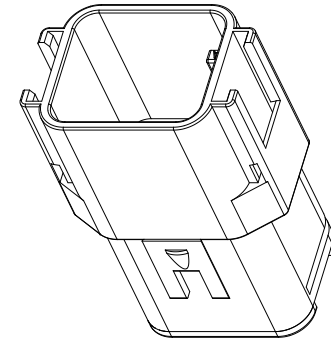
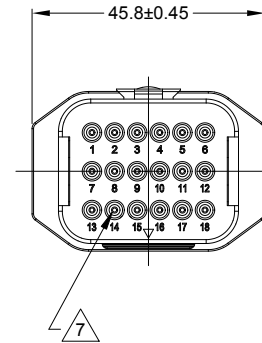
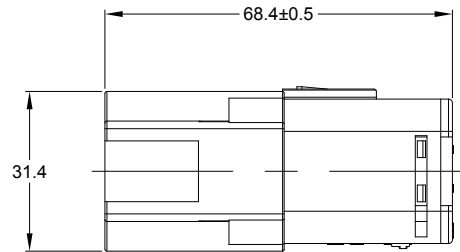
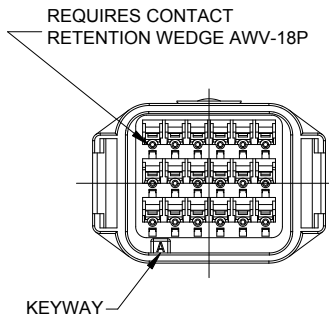
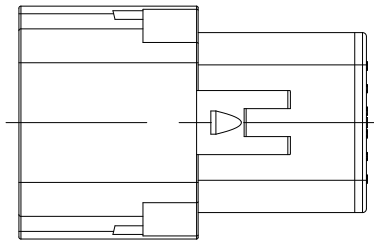

NOTES: UNLESS OTHERWISE SPECIFIED

- SEE SHEET 2 FOR KEY ARRANGEMENTS AND COLORS.
- MATERIAL:
HOUSING: THERMOPLASTIC
SEAL: SILICONE RUBBER, COLOR: YELLOW
- MODIFICATIONS: IN LINE
REDUCED DIAMETER WIRE SEAL
- SPECIFICATIONS:
 - CURRENT RATING: 13 AMPS
 - OPERATING TEMPERATURE: -55°C TO +125°C.
 - DIELECTRIC WITHSTANDING VOLTAGE: LESS THAN 2 MILLIAMPS CURRENT LEAKAGE @ 1500 VOLTS AC.
 - INSULATION RESISTANCE: 1000 MEGOHMS MIN @ 25°C.
 - MOISTURE RESISTANCE: IP67&IP69K (MATED CONDITION)
 - MATING CYCLE DURABILITY: 100 CYCLES
 - RoHS COMPLIANT
- MATING PART: ATV06-18SX* PLUG
(X = A,B,C,D KEYS ; * = MODIFICATIONS AND COLORS)
- ALL DIMENSIONS ARE FOR REFERENCE USE ONLY.

7 CONTACT SIZE AND REAR SEAL WIRE RANGE:

CONTACT SIZE	MIN. INSUL O.D.	MAX. INSUL O.D.	TYPICAL WIRE RANGE
16	1.12 mm (.044 in)	2.31 mm (.090 in)	16 - 22 AWG

SEE SHEET 2		DESCRIPTION		ITEM
QUANTITY	PART NUMBER	MATERIALS LIST		
UNLESS OTHERWISE SPECIFIED		SIGNATURES		DATE
1) All dimensions are in metric(mm).		DRAWN: SULLENZHANG	19FEB19	
2) Tolerances are as follows:		CHECKED: ORIONLI	19FEB19	
1 PL DEC ±0.30		ENGINEER:		
2 PL DEC ±0.15		APPROVAL: TOMMYXIE	19FEB19	
3 PL DEC ±0.08		CUSTOMER:		
3) Note reference =		THIS DRAWING IS SUPPLIED FOR INFORMATION ONLY. DESIGN FEATURES, SPECIFICATIONS AND PERFORMANCE DATA SHOWN HEREON ARE THE PROPERTY OF THE AMPHENOL CORPORATION. NO RIGHTS OF REPRODUCTION ARE IMPLIED. ALL DIMENSIONS ARE SUBJECT TO NORMAL MANUFACTURING VARIATIONS.		
MATERIAL SPECIFICATIONS:		Sine Systems - www.amphenol-sine.com 44724 Morley Drive Clinton Township, MI 48036		
PROCESS SPECIFICATIONS:		RECEPTACLE, IN LINE, 18 PIN, ATV SERIES REDUCED DIAMETER WIRE SEAL		
NEXT ASSY:		SIZE	TYPE	DWG NO.
		B	C-	ATV04-18PX-RR01
		SCALE	NONE	REVISION
				A2
				SHEET 1 OF 2

TITLE: RECEPTACLE, IN LINE, 18 PIN, ATV SERIES, REDUCED DIAMETER WIRE SEAL
DWG NO.: ATV04-18PX-RR01
REV: A2
SH: 1
OF: 2

REVISIONS					
REV	ECO	DESCRIPTION	DATE	BY	APPR
A1	-	RELEASE DRAWING	03MAY18	RIMON	TOMMY
A2	-	UPDATE NOTES	19FEB19	SULLEN	TOMMY

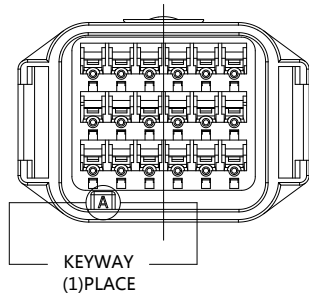

KEY-A CONFIGURATION	
COLOR	PART NUMBER
GREY	ATV04-18PA-RR01

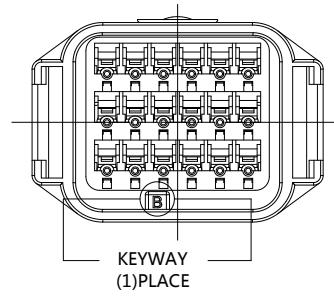

KEY-B CONFIGURATION	
COLOR	PART NUMBER
BLACK	ATV04-18PB-RR01

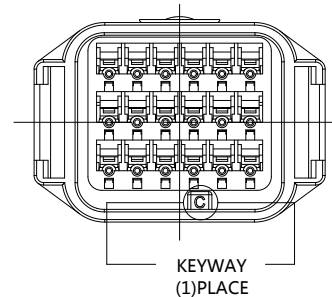

KEY-C CONFIGURATION	
COLOR	PART NUMBER
GREEN	ATV04-18PC-RR01

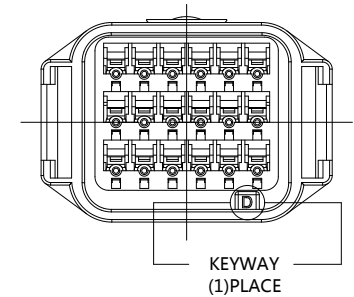



KEY-D CONFIGURATION	
COLOR	PART NUMBER
BROWN	ATV04-18PD-RR01

SEE CONFIGURATION CHART		DESCRIPTION		ITEM
QUANTITY	PART NUMBER			
MATERIALS LIST				
UNLESS OTHERWISE SPECIFIED 1) All dimensions are in metric(mm). 2) Tolerances are as follows: 1 PL DEC ±0.30 2 PL DEC ±0.15 3 PL DEC ±0.08 Fractions ±1/64 Angles ±1° 3) Note reference =		SIGNATURES DATE DRAWN: SULLENZHANG 19FEB19 CHECKED: ORIONLI 19FEB19 ENGINEER: APPROVAL: TOMMYXIE 19FEB19 CUSTOMER:		Amphenol Sine Systems - www.amphenol-sine.com 44724 Morley Drive Clinton Township, MI 48036
MATERIAL SPECIFICATIONS:		THIS DRAWING IS SUPPLIED FOR INFORMATION ONLY. DESIGN FEATURES, SPECIFICATIONS AND PERFORMANCE DATA SHOWN HEREON ARE THE PROPERTY OF THE AMPHENOL CORPORATION. NO RIGHTS OF REPRODUCTION ARE IMPLIED. ALL DIMENSIONS ARE SUBJECT TO NORMAL MANUFACTURING VARIATIONS.		RECEPTACLE, IN LINE, 18 PIN, ATV SERIES REDUCED DIAMETER WIRE SEAL SIZE: B C- TYPE: DWG NO: ATV04-18PX-RR01 REVISION: A2 SCALE: NONE SHEET 2 OF 2
PROCESS SPECIFICATIONS:		NEXT ASSY:		

TITLE: RECEPTACLE IN LINE, 18 PIN, ATV SERIES, REDUCED DIAMETER WIRE SEAL
 DWG NO: ATV04-18PX-RR01
 REV: A2
 SH: 2
 OF: 2

AT Series™ - Contact Size 16 Options

Machined Contacts, Sockets & Pins				
Part Number	Description	Size	AWG	Type
AT60-215-1631	Male Contact - Pin, Gold-plated	16	14	Machined
AT62-209-1631	Female Contact - Socket, Gold-plated	16	14	Machined
AT60-215-16141	Male Contact - Pin, Nickel-plated	16	14	Machined
AT62-209-16141	Female Contact - Socket, Nickel-plated	16	14	Machined
AT60-202-1631	Male Contact - Pin, Gold-plated	16	16-20	Machined
AT62-201-1631	Female Contact - Socket, Gold-plated	16	16-20	Machined
AT60-202-16141	Male Contact - Pin, Nickel-plated	16	16-20	Machined
AT62-201-16141	Female Contact - Socket, Nickel-plated	16	16-20	Machined
AT60-202-1631-22	Male Contact - Pin, Gold-plated	16	22-24	Machined
AT62-201-1631-22	Female Contact - Socket, Gold-plated	16	22-24	Machined
AT60-202-16141-22	Male Contact - Pin, Nickel-plated	16	22-24	Machined
AT62-201-16141-22	Female Contact - Socket, Nickel-plated	16	22-24	Machined

Tooling - Machined Contacts		
Part	Part Number	Description
	CA-5D12	Universal Hand Crimp Tool, Size 12/16/20 (Machined contacts only)
	CA-5E12	Pneumatic Crimp Tool, Size 12/16/20 (Machined contacts only)

Contact Removal Tools		
Part	Part Number	Description
	ATRT-100	Used for removal of contacts for A Series™ products
	AT11-310-1605	Contact Removal Tool, Plastic, Size 16
	A114017	Sealing Plug, Size 16, White

Stamped & Formed Contacts, Sockets & Pins				
Part Number	Description	Size	AWG	Type
AT60-14-0144	Male Contact - Pin, Gold-plated	16	14-16	Stamped & Formed
AT62-14-0144	Female Contact - Socket, Gold-plated	16	14-16	Stamped & Formed
AT60-14-0122	Male Contact - Pin, Nickel-plated	16	14-16	Stamped & Formed
AT62-14-0122	Female Contact - Socket, Nickel-plated	16	14-16	Stamped & Formed
AT60-16-0144	Male Contact - Pin, Gold-plated	16	16-18	Stamped & Formed
AT62-16-0144	Female Contact - Socket, Gold-plated	16	16-18	Stamped & Formed
AT60-16-0122	Male Contact - Pin, Nickel-plated	16	16-18	Stamped & Formed
AT62-16-0122	Female Contact - Socket, Nickel-plated	16	16-18	Stamped & Formed
AT60-16-0644	Male Contact - Pin, Gold-plated	16	18-20	Stamped & Formed
AT62-16-0644	Female Contact - Socket, Gold-plated	16	18-20	Stamped & Formed
AT60-16-0622	Male Contact - Pin, Nickel-plated	16	18-20	Stamped & Formed
AT62-16-0622	Female Contact - Socket, Nickel-plated	16	18-20	Stamped & Formed
AT60-16-0844	Male Contact - Pin, Gold-plated	16	20-22	Stamped & Formed
AT62-16-0844	Female Contact - Socket, Gold-plated	16	20-22	Stamped & Formed
AT60-16-0822	Male Contact - Pin, Nickel-plated	16	20-22	Stamped & Formed
AT62-16-0822	Female Contact - Socket, Nickel-plated	16	20-22	Stamped & Formed

Tooling - Stamped & Formed Contacts		
Part	Part Number	Description
	MF3-3950	Crimp Die - Size 16, 18-20AWG (S&F contacts only)
	MF3-3953	Crimp Die - Size 16, 16-18AWG (S&F contacts only)
	MF3-3975	Crimp Die - Size 16, 14-16AWG (S&F contacts only)
	MF3-3990	Crimp Die - Size 16, 20-22AWG (S&F contacts only)
	ATT-16-00	Hand Crimp Tool - Size 16, 14-16AWG (S&F contacts only)
	ATT-16-01	Hand Crimp Tool - Size 16, 18-20AWG (S&F contacts only)
	ATT-1612-03	Hand Crimp Tool - Size 16, 20-22AWG (S&F contacts only)

Amphenol Sine Systems
 44724 Morley Drive
 Clinton Township, MI 48036 USA
www.amphenol-sine.com
 09/2021