

BILLIE-B

Asymmetric beam for wall-washing. Assembly with holder and installation tape.

TECHNICAL SPECIFICATIONS:

Dimensions	Ø 21.5 mm
Height	16.1 mm
Fastening	pin, tape
Colour	white
Box size	480 x 280 x 300 mm
Box weight	0 kg
Quantity in Box	1792 pcs
ROHS compliant	yes ⓘ



MATERIAL SPECIFICATIONS:

Component	Type	Material	Colour
BILLIE-B	Single lens	PMMA	clear
BILLIE-HLD-PIN-TAPE	Holder	PC	white
HEIDI-TAPE	Tape	PU tape	black

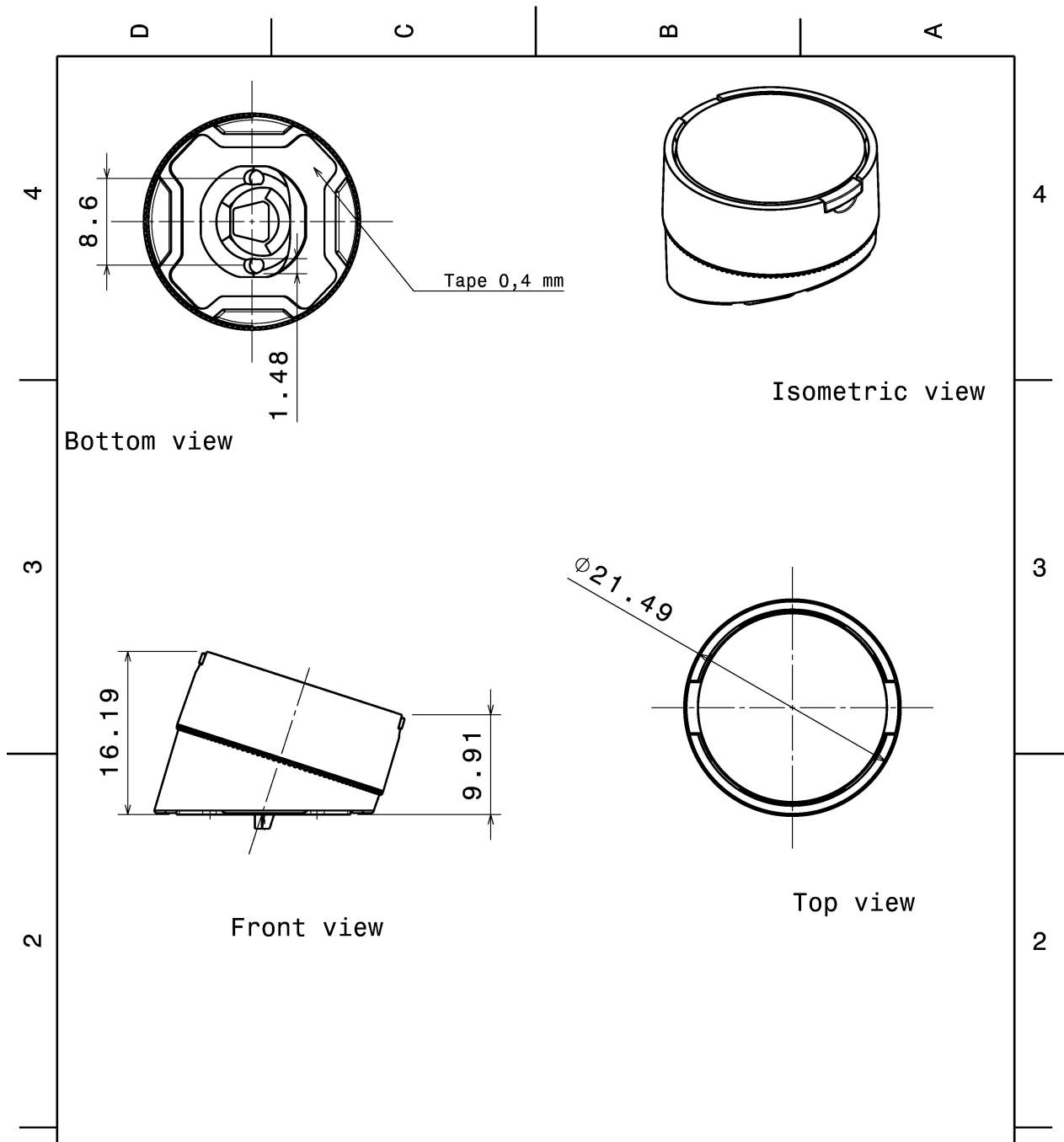

Tolerances if not otherwise shown
According to DIN ISO 2768-1
Linear measures:
Up to 30mm class M, otherwise class C.
According to DIN ISO 2768-2
Form and position: class L

LEDiL

Ledil Oy
Salorankatu 10
FIN 24240 SALO
Finland

THIRD ANGLE PROJECTION:

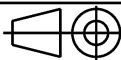

DRAWING TITLE

BILLIE datasheet

This drawing is the property of LEDiL Oy. It may not be reproduced, copied or communicated without a written agreement with LEDiL Oy."

SIZE PART NUMBER

A4

SCALE 2:1 WEIGHT -

SHEET 1/1

PHOTOMETRIC DATA (MEASURED):



LED XP-E
 FWHM Asymmetric
 Efficiency 94 %
 Peak intensity 2.500 cd/lm
 LEDs/each optic 1
 Light colour White
 Required components:

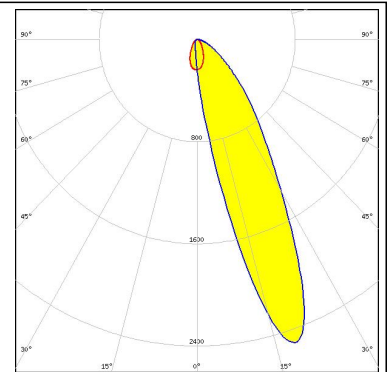
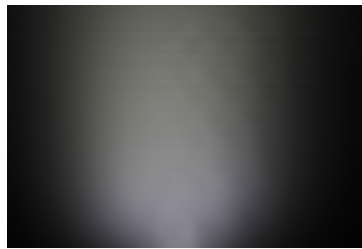

LED XP-G
 FWHM Asymmetric
 Efficiency 93 %
 Peak intensity 2.300 cd/lm
 LEDs/each optic 1
 Light colour White
 Required components:

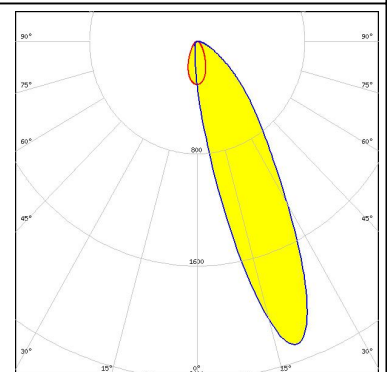
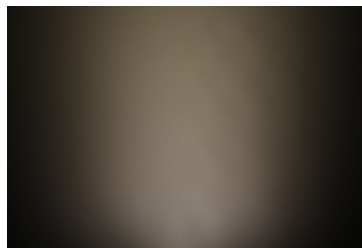

LED LUXEON Rebel
 FWHM Asymmetric
 Efficiency 93 %
 Peak intensity 2.100 cd/lm
 LEDs/each optic 1
 Light colour White
 Required components:

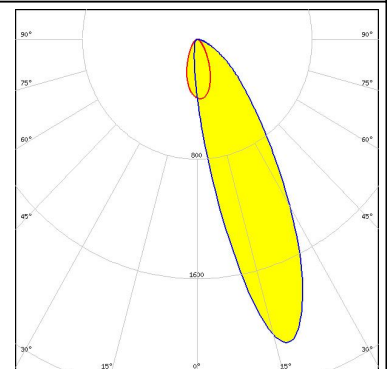
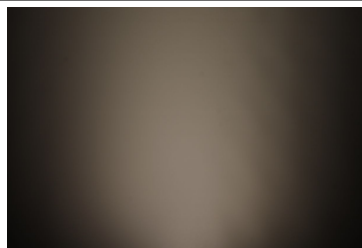

LED LUXEON Rebel ES
 FWHM Asymmetric
 Efficiency 92 %
 Peak intensity 2.000 cd/lm
 LEDs/each optic 1
 Light colour White
 Required components:

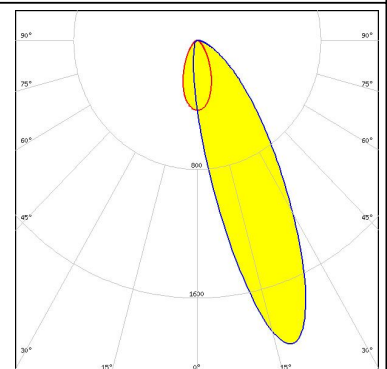
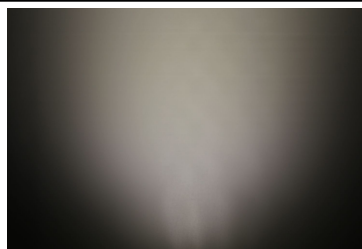

PHOTOMETRIC DATA (MEASURED):

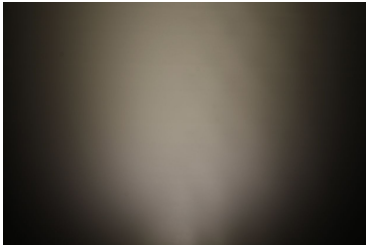
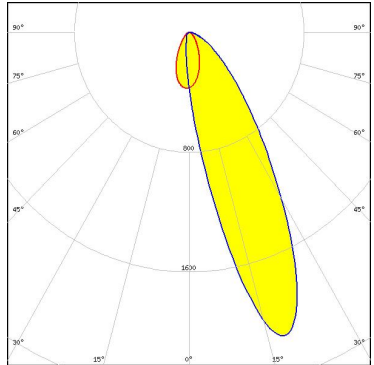
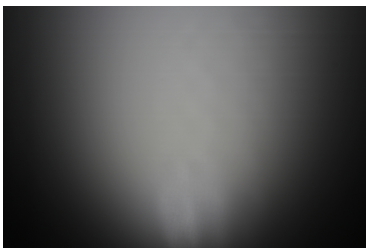
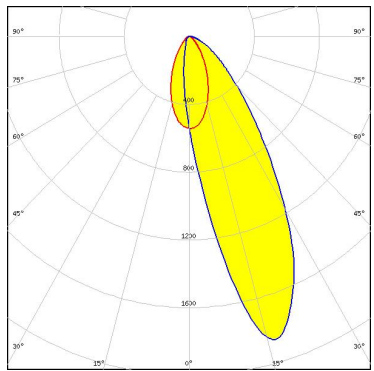
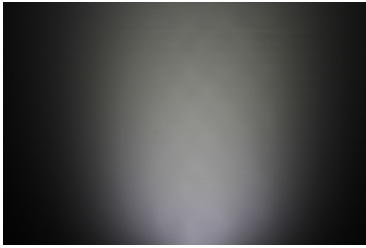
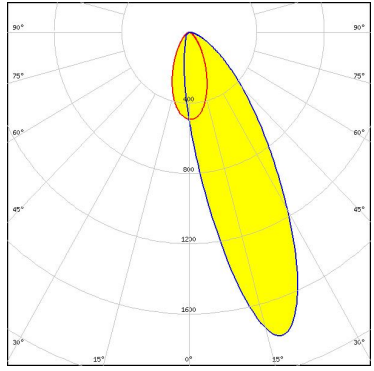
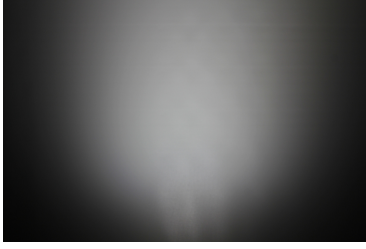
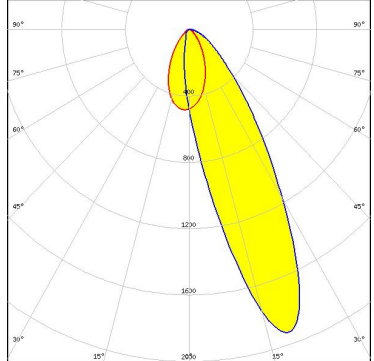
<p>NICHIA</p> <p>LED NCSxx19B FWHM Asymmetric Efficiency 92 % Peak intensity 2.100 cd/lm LEDs/each optic 1 Light colour White Required components:</p>		
<p>NICHIA</p> <p>LED NF2x757D FWHM Asymmetric Efficiency 93 % Peak intensity 1.900 cd/lm LEDs/each optic 1 Light colour White Required components:</p>		
<p>NICHIA</p> <p>LED NVSxx19B/NVSxx19C FWHM Asymmetric Efficiency 91 % Peak intensity 1.800 cd/lm LEDs/each optic 1 Light colour White Required components:</p>		
<p>OSRAM <small>Opto Semiconductors</small></p> <p>LED Duris S5 (2 chip) FWHM Asymmetric Efficiency 93 % Peak intensity 1.900 cd/lm LEDs/each optic 1 Light colour White Required components:</p>		

PHOTOMETRIC DATA (MEASURED):

OSRAM
Opto Semiconductors

LED Oslon Square EC
FWHM Asymmetric
Efficiency 93 %
Peak intensity 2.000 cd/lm
LEDs/each optic 1
Light colour White
Required components:

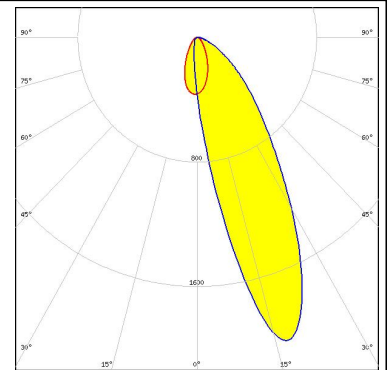
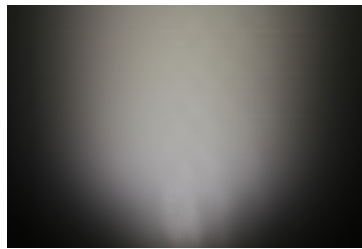

SAMSUNG

LED LH351B
FWHM Asymmetric
Efficiency 93 %
Peak intensity 2.100 cd/lm
LEDs/each optic 1
Light colour White
Required components:

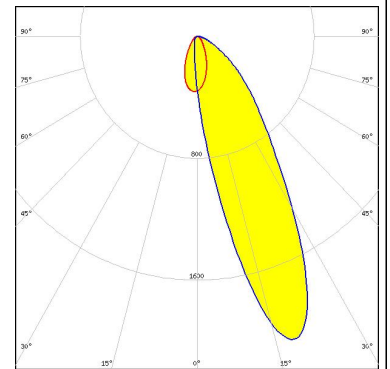
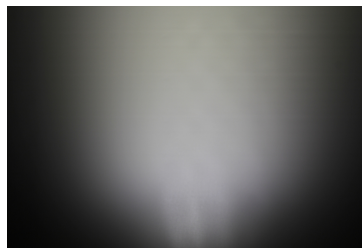

SAMSUNG

LED LH351Z
FWHM Asymmetric
Efficiency 94 %
Peak intensity 2.300 cd/lm
LEDs/each optic 1
Light colour White
Required components:

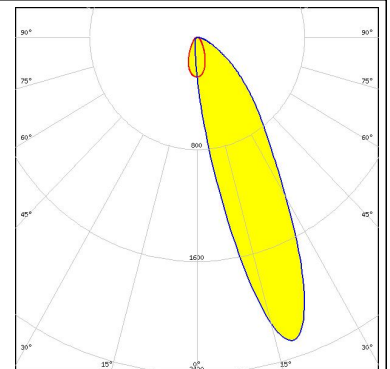
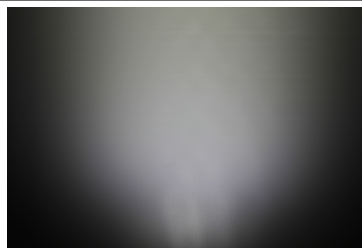

SEOUL SEMICONDUCTOR

LED Z5M1/Z5M2
FWHM Asymmetric
Efficiency 94 %
Peak intensity 2.200 cd/lm
LEDs/each optic 1
Light colour White
Required components:

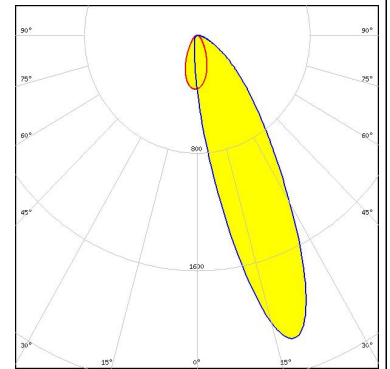
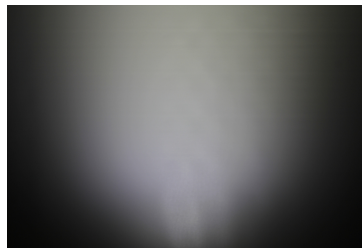

PHOTOMETRIC DATA (SIMULATED):



LED NF2x757G
FWHM Asymmetric
Efficiency 93 %
Peak intensity 2.000 cd/lm
LEDs/each optic 1
Light colour White
Required components:

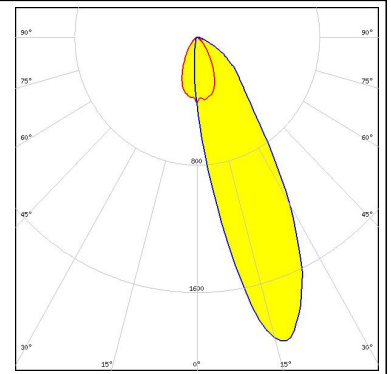

GENERAL INFORMATION:

NOTE: The typical beam angle will be changed by different color, chip size and chip position tolerance. The typical total beam angle is the full angle measured where the luminous intensity is half of the peak value.

MATERIALS:

As part of our continuous research and improvement processes, and to ensure the best possible quality and availability of our products, LEDiL reserves the right to change material grades without notice.

PRODUCT DATA USER AGREEMENT AND DISCLAIMER:

The measured data in the provided downloadable LEDiL Product Datasheets and Mechanical 2D-Drawings is rounded and provided as reference for planning. LEDiL Oy's optical specifications have been verified by conducting performance testing of the products in accordance with the company's quality system. The reported data are averaged results of multiple measurements with typical variation. LEDiL Oy reserves the right to without prior notification make changes and improvements to its products.

LEDiL Oy assumes neither warranty, nor guarantee nor any other liability of any kind for the contents and correctness of the provided data. The provided data has been generated with highest diligence but the provided data may in reality not represent the complete possible variation range of all intrinsic parameters. Therefore, in certain cases a deviation from the provided data could occur.

LEDiL Oy reserves the right to undertake technical changes of its products without further notification which could lead to changes in the provided data. LEDiL Oy assumes no liability of any kind for the possible deviation from any provided data or any other damage resulting from the usage of the provided data.

The user agrees to this disclaimer and user agreement with the download or usage of the provided files.

LEDiL Oy

Joensuunkatu 13
FI-24240 SALO
Finland

LEDiL Inc.

228 West Page Street
Suite D
Sycamore IL 60178
USA

Local sales and technical support

[www.ledil.com/
where_to_buy](http://www.ledil.com/where_to_buy)

Shipping locations

Salo, Finland
Hong Kong, China

Distribution Partners

[www.ledil.com/
where_to_buy](http://www.ledil.com/where_to_buy)