

Data sheet | Item number: 2020-206

2-conductor female connector; Push-in CAGE CLAMP®; 1.5 mm²; Pin spacing 3.5 mm; 6-pole; 1,50 mm²; gray

www.wago.com/2020-206

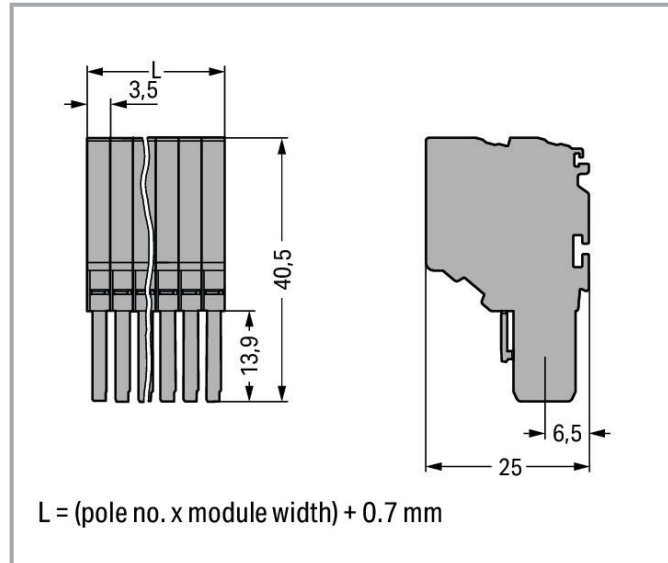
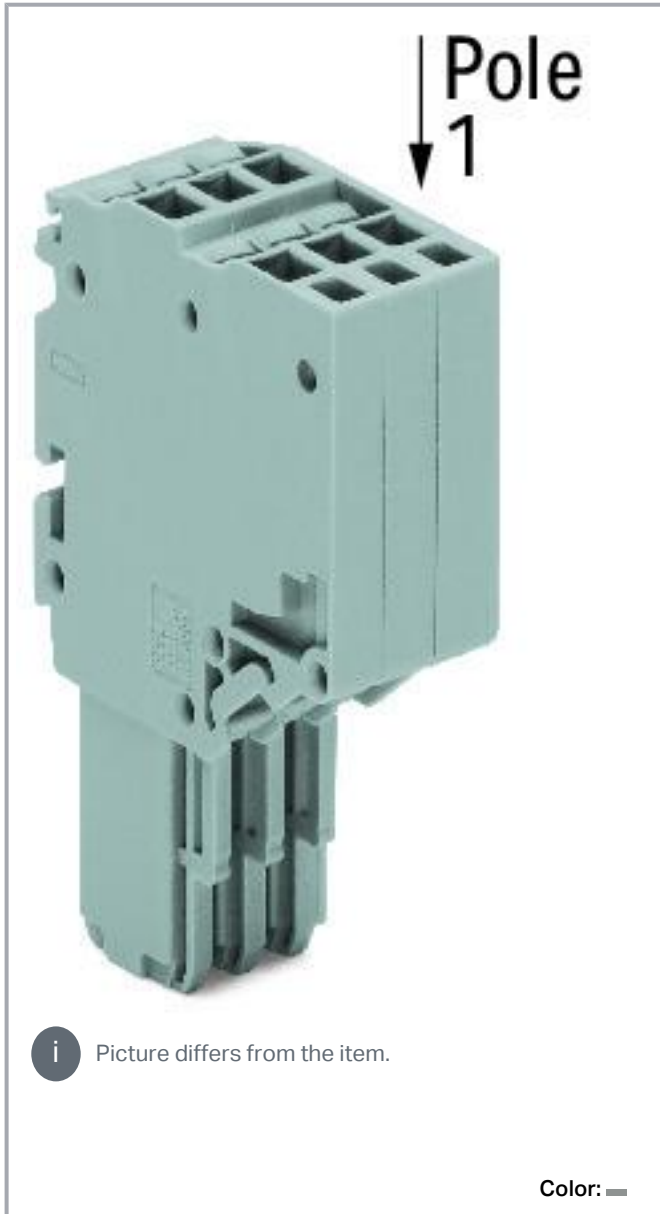

Subject to changes. Please also observe the further product documentation!

WAGO GmbH & Co. KG
Hansastr. 27
32423 Minden
Phone: +49571 887-0 | Fax: +49571 887-169
Email: info.de@wago.com | Web: www.wago.com

Do you have any questions about our products?
We are always happy to take your call at +49 (571) 887-44222.



Data

Notes

Safety information	According to EN 61984, pluggable connectors without current interrupting capacity must not be mated or unmated when live or under load.
Safety information 2	Notice: An appropriate end plate must be applied to the carrier terminal blocks after each female plug.

Electrical data

Ratings per IEC/EN

Ratings per	IEC/EN 61984
Nominal voltage (III/3)	500 V
Rated impulse voltage (III/3)	6 kV
Rated current	13.5 A
Legend (ratings)	(III / 3) ≙ Overvoltage category III / Pollution degree 3

Ratings per UL 1059

Approvals per	UL 1059
Rated voltage UL (Use Group B)	300 V
Rated current UL (Use Group B)	15 A
Rated voltage UL (Use Group C)	300 V
Rated current UL (Use Group C)	15 A
Rated voltage UL (Use Group D)	300 V
Rated current UL (Use Group D)	15 A

Ratings per CSA

Approvals per	CSA 22.2 No 158
Rated voltage CSA (Use Group B)	300 V
Rated current CSA (Use Group B)	10 A
Rated voltage CSA (Use Group C)	300 V
Rated current CSA (Use Group C)	10 A
Rated voltage CSA (Use Group D)	300 V
Rated current CSA (Use Group D)	10 A

Subject to changes. Please also observe the further product documentation!



Connection data

Connection points	12
Total number of potentials	6

Connection 1

Connection technology	Push-in CAGE CLAMP®
Actuation type	Operating tool
Connectable conductor materials	Copper
Nominal cross-section	1 mm ²
Solid conductor	0.14 ... 1.5 mm ² / 24 ... 16 AWG
Solid conductor; push-in termination	0.5 ... 1.5 mm ² / 20 ... 16 AWG
Fine-stranded conductor	0.14 ... 1.5 mm ² / 24 ... 16 AWG
Fine-stranded conductor; with insulated ferrule	0.14 ... 0.75 mm ² / 24 ... 18 AWG
Fine-stranded conductor; with ferrule; push-in termination	0.5 ... 0.75 mm ² / 20 ... 18 AWG
Note (conductor cross-section)	Depending on the conductor characteristic, a conductor with a smaller cross-section can also be inserted via push-in termination.
Strip length	9 ... 11 mm / 0.35 ... 0.43 inches
Pole number	6
Wiring direction	Front-entry wiring

Physical data

Width	21.7 mm / 0.854 inches
Height	40.5 mm / 1.594 inches
Depth	25 mm / 0.984 inches
Module width	3.5 mm / 0.138 inches

Mechanical Data

Variable coding	Yes
Marking level	Side marking
Anti-rotation protection	Yes

Plug-in connection

Contact type (pluggable connector)	Female connector/socket
Connector (connection type)	for conductor
Mismating protection	No

Subject to changes. Please also observe the further product documentation!



Plugging without loss of pin spacing

No

Material Data

Note (material data)

Information on material specifications can be found here

Color	gray
Material group	I
Insulation material	Polyamide (PA66)
Flammability class per UL94	V0
Fire load	0.28 MJ
Weight	16.8 g

Environmental requirements

Processing temperature	-35 ... +85 °C
Continuous operating temperature	-60 ... +105 °C

Commercial data

Product Group	18 (X-COM-System)
eCl@ss 10.0	27-14-11-06
eCl@ss 9.0	27-14-11-06
ETIM 8.0	EC001284
ETIM 7.0	EC001284
PU (SPU)	25 pcs
Packaging type	Box
Country of origin	DE
GTIN	4045454855284
Customs tariff number	85366990990

Environmental Product Compliance

RoHS Compliance Status	Compliant, No Exemption
------------------------	-------------------------

Approvals / Certificates

General approvals

Logo	Approval	Additional Approval Text	Certificate name
	CCA	EN 60947	NTR NL

Subject to changes. Please also observe the further product documentation!

WAGO GmbH & Co. KG
Hansastr. 27
32423 Minden
Phone: +49571 887-0 | Fax: +49571 887-169
Email: info.de@wago.com | Web: www.wago.com

Do you have any questions about our products?
We are always happy to take your call at +49 (571) 887-44222.



DEKRA Certification B.V.

7617

CSA
DEKRA Certification B.V.

C22.2



2516073

UL
UL International Germany GmbH





UL 1059

E 45172

Declarations of conformity and manufacturer's declarations

Logo	Approval	Additional Approval Text	Certificate name
	EU-Declaration of Conformity WAGO GmbH & Co. KG	-	-
	UK-Declaration of Conformity WAGO GmbH & Co. KG	-	-

Approvals for marine applications

Logo	Approval	Additional Approval Text	Certificate name
	ABS American Bureau of Shipping	EN 60947	20- HG1941090- PDA
	BV Bureau Veritas S.A.	EN 60947	38586/B0 BV
	DNV GL Det Norske Veritas, Germanischer Lloyd	-	TAE00001V2
	LR Lloyds Register	EN 60947	91/20112 (E9)



Subject to changes. Please also observe the further product documentation!

WAGO GmbH & Co. KG
Hansastr. 27
32423 Minden
Phone: +49571 887-0 | Fax: +49571 887-169
Email: info.de@wago.com | Web: www.wago.com



Do you have any questions about our products?
We are always happy to take your call at +49 (571) 887-44222.

Optional accessories

Tool

Operating tool		
	Item no.: 210-648 Operating tool; Blade: 2.5 x 0.4 mm; with a partially insulated shaft; angled; short	www.wago.com/210-648
	Item no.: 210-647 Operating tool; Blade: 2.5 x 0.4 mm; with a partially insulated shaft; multicoloured	www.wago.com/210-647
	Item no.: 210-719 Operating tool; Blade: 2.5 x 0.4 mm; with a partially insulated shaft	www.wago.com/210-719



Marking accessories

Marker		
	Item no.: 2009-113 WMB-Inline; for Smart Printer; 2300 pieces on roll; plain; snap-on type; white	www.wago.com/2009-113
	Item no.: 793-3501 WMB marking card; as card; plain; snap-on type; white	www.wago.com/793-3501

Protective warning marker

Cover		
	Item no.: 2000-115 Protective warning marker; for 5 terminal blocks; with high-voltage symbol, black; yellow	www.wago.com/2000-115

Locking levers

Locking system		
	Item no.: 2022-151 Locking lever; gray	www.wago.com/2022-151
	Item no.: 2022-152 Locking lever; orange	www.wago.com/2022-152

Strain relief

Strain relief plate		
	Item no.: 734-328 Strain relief plate; for female and male connectors; 12.5 mm wide; 1 part; gray	www.wago.com/734-328

Ferrule

Ferrule		
	Item no.: 216-241 Ferrule; Sleeve for 0.5 mm ² / 20 AWG; insulated; electro-tin plated; electrolytic copper; gastight	www.wago.com/216-241

Subject to changes. Please also observe the further product documentation!



crimped; acc. to DIN 46228, Part 4/09.90; white

Item no.: 216-242Ferrule; Sleeve for 0.75 mm² / 18 AWG; insulated; electro-tin plated; electrolytic copper; gastight crimped; acc. to DIN 46228, Part 4/09.90; graywww.wago.com/216-242**Item no.: 216-243**Ferrule; Sleeve for 1 mm² / AWG 18; insulated; electro-tin plated; electrolytic copper; gastight crimped; acc. to DIN 46228, Part 4/09.90; red**Downloads****Documentation****Bid Text**

2020-206 X81 - Datei	2019 Feb 19	xml 4.0 kB	Download
2020-206 docx - Datei	2018 Aug 7	docx 15.4 kB	Download

Additional Information

Technical Section Technical explanations		pdf 2.2 MB	Download
---	--	---------------	----------

CAD/CAE-Data**CAD data**

2D/3D Models 2020-206		URL	Download
-----------------------	--	-----	----------

CAE data

EPLAN Data Portal 2020-206		URL	Download
----------------------------	--	-----	----------

WSCAD Universe 2020-206		URL	Download
-------------------------	--	-----	----------

ZUKEN Portal 2020-206		URL	Download
-----------------------	--	-----	----------

Environmental Product Compliance**Compliance Search**

Environmental Product Compliance 2020-206		URL	Download
---	--	-----	----------

Subject to changes. Please also observe the further product documentation!

2-conductor female connector; Push-in CAGE CLAMP®; 1.5 mm²; Pin spacing 3.5 mm;
6-pole; 1,50 mm²; gray

Installation Notes

Coding

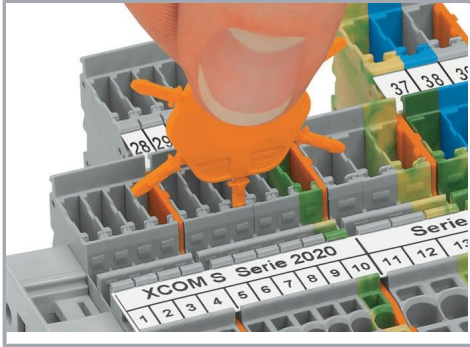

Insert coding pin into the corresponding slot and twist it off.



Coding a female plug: remove coding finger using a suitable tool.

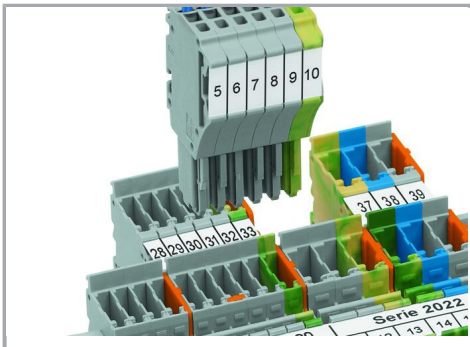

Insert coded female plug into X-COM®S-SYSTEM terminal block assembly.

Locking system

Subject to changes. Please also observe the further product documentation!

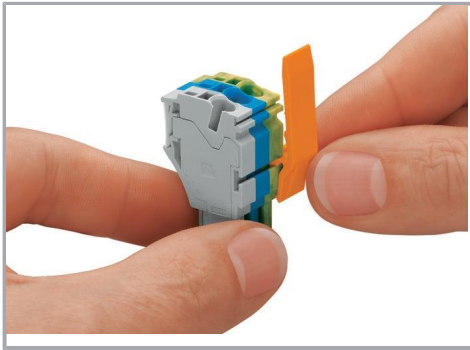

Slide the locking lever into position.

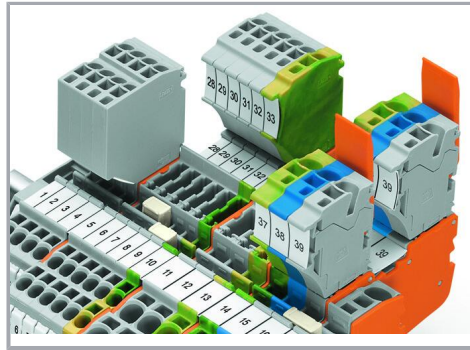

Female plugs can be individually locked.

Product family

X-COM S-Mini

[Show all products from the family](#)

Subject to changes. Please also observe the further product documentation!