

DESCRIPTION: COAXIAL / SIGNAL - RIGHT ANGLE - MALE

SPECIFICATIONS:

ELECTRICAL:
 INSULATOR RESISTANCE: 5,000 MegOHMS Min.
 DIELECTRIC WITHSTANDING: 1,000VAC r.m.s.
 OPERATING TEMPERATURE: -55° C ~ +125° C
 CONTACT RESISTANCE: 30 MillioHMS Max.
 COAXIAL PINS: 50 OHM
 SIGNAL PINS: 5 AMPS

MECHANICAL:
 CONTACT INSERTION FORCE: 4.5 Kg Max.
 CONTACT SEPARATOR FORCE: 0.3Kg Min.

MATERIALS:
 CONTACTS: BRASS
 INSULATOR: PBT UL94V-0 RATED,
 230°C PROCESS TEMP.
 SHELL: STEEL

FINISH:
 SHELL: NICKEL

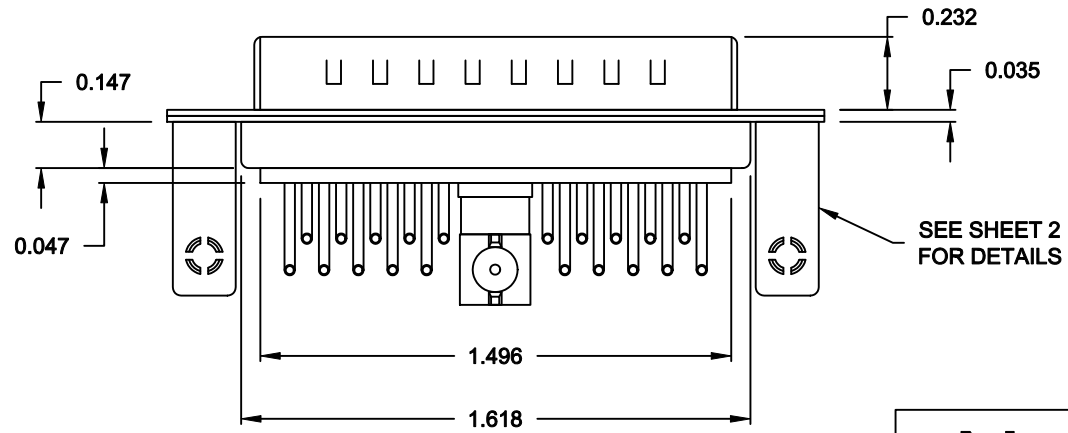
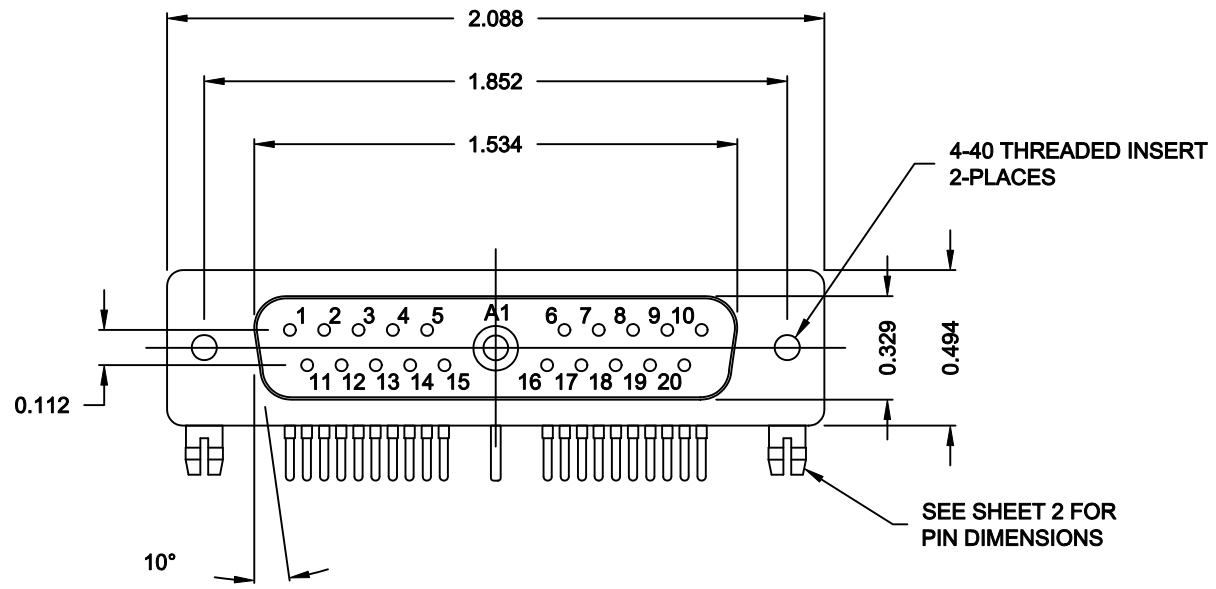

68521W1103L461

46 = 4-40 INSERTS / BOARD LOCKS

RoHS COMPLIANT

	THESE DRAWINGS AND SPECIFICATIONS ARE THE PROPERTY OF NorComp AND SHALL NOT BE REPRODUCED, COPIED OR USED AS THE BASIS FOR THE MANUFACTURE OR SALE OF APPARATUS WITHOUT WRITTEN PERMISSION.		DRAWN: C. SMITH	DATE: 10-11-06
			CHECKED:	DATE:
NorComp		SCALE: 1.5 = 1	SHEET 1 OF 2	REV 2
		DWG NO. 68521W1103L461		

DESCRIPTION: 685 SERIES CONTACTS

NOTE:
POWER CONTACTS COME
PRE-LOADED INTO INSULATORS

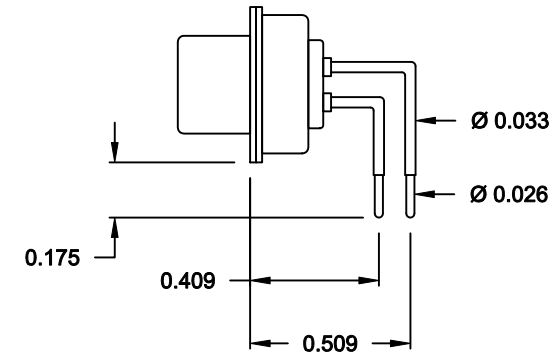
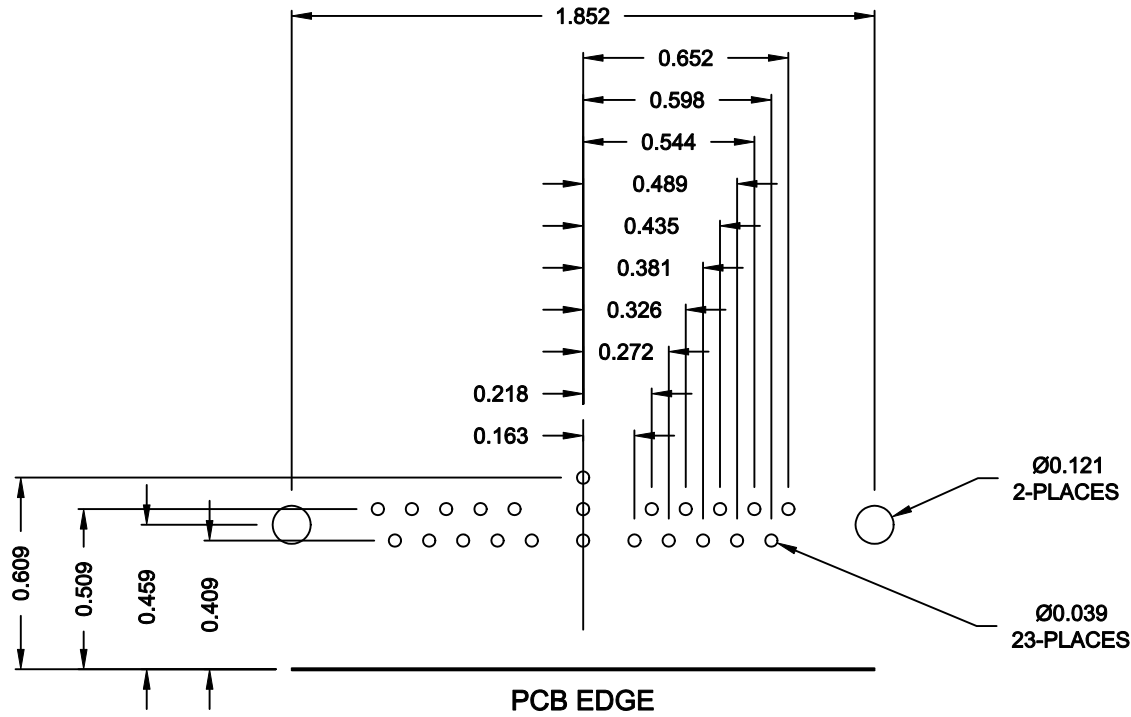

SIGNAL CONTACTS

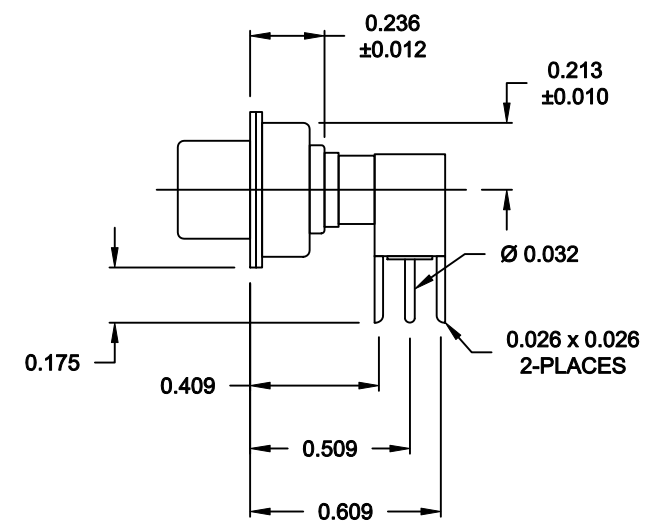

50 OHM COAXIAL CONTACT

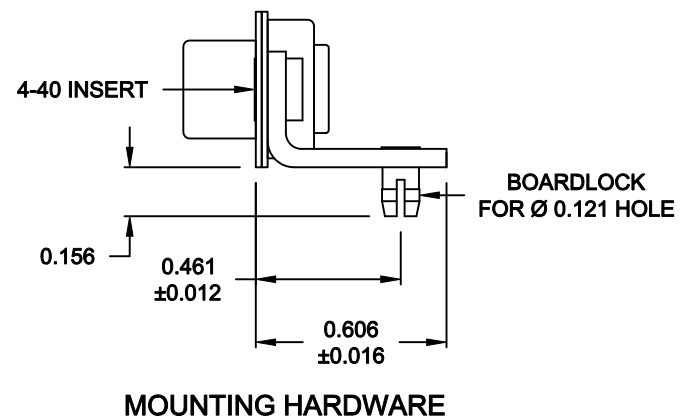

RoHS COMPLIANT

	THESE DRAWINGS AND SPECIFICATIONS ARE THE PROPERTY OF NorComp AND SHALL NOT BE REPRODUCED, COPIED OR USED AS THE BASIS FOR THE MANUFACTURE OR SALE OF APPARATUS WITHOUT WRITTEN PERMISSION.		DRAWN: C. SMITH	DATE: 10-11-06	
	<h1>NorComp</h1>			CHECKED:	DATE:
SCALE: 1.5 = 1				SHEET 2 OF 2	REV 2
DWG NO. 68521W1103L461					