

LAURA-RS-PG

~8° spot beam. Assembly with white holder and location pins.

TECHNICAL SPECIFICATIONS:

Dimensions	21.6 mm
Height	13.1 mm
Fastening	glue, pin
ROHS compliant	yes ⓘ

MATERIAL SPECIFICATIONS:

Component	Type	Material	Colour	Finish
LAURA-RS	Single lens	PMMA		
LAURA-HLD-PIN	Holder	PC		



ORDERING INFORMATION:

Component		Qty in box	MOQ	MPQ	Box weight (kg)
CP12631_LAURA-RS-PG	Single lens	1960	294	98	10.9
» Box size: 480 x 280 x 300 mm					

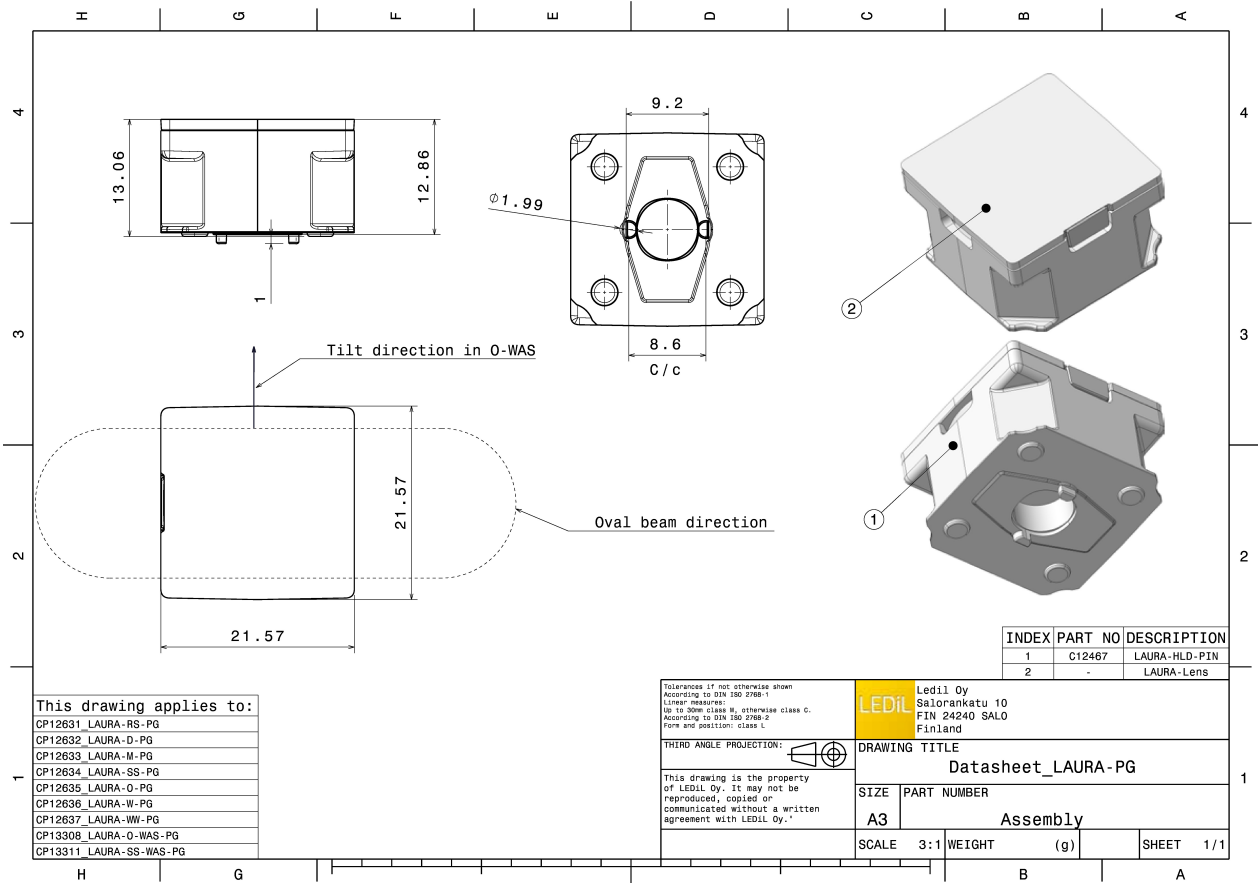

PHOTOMETRIC DATA (MEASURED):



LED XP-G
FWHM 10.0°
Efficiency 92 %
Peak intensity 20.300 cd/lm
LEDs/each optic 1
Light colour White
Required components:

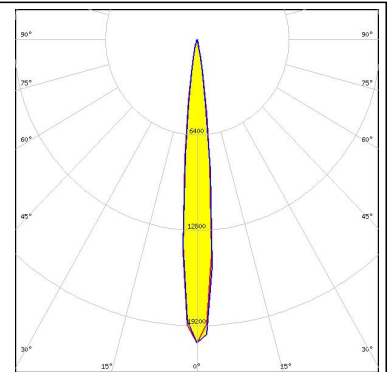
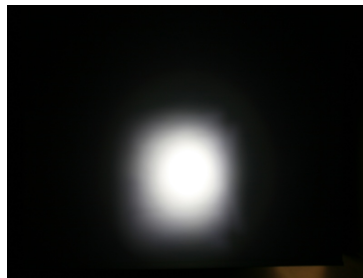

LED LUXEON A
FWHM 11.0°
Efficiency 93 %
Peak intensity 17.800 cd/lm
LEDs/each optic 1
Light colour White
Required components:

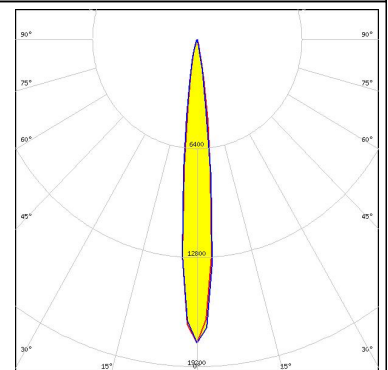

LED LUXEON Rebel
FWHM 7.0°
Efficiency 93 %
Peak intensity 34.000 cd/lm
LEDs/each optic 1
Light colour White
Required components:

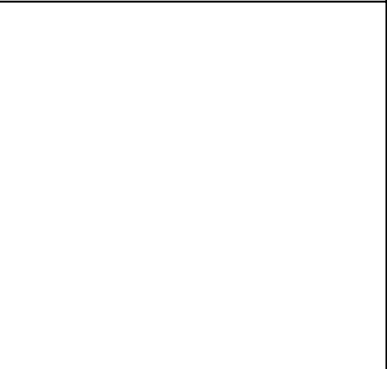

LED NVSxx19A
FWHM 10.0°
Efficiency 92 %
Peak intensity 16.800 cd/lm
LEDs/each optic 1
Light colour White
Required components:

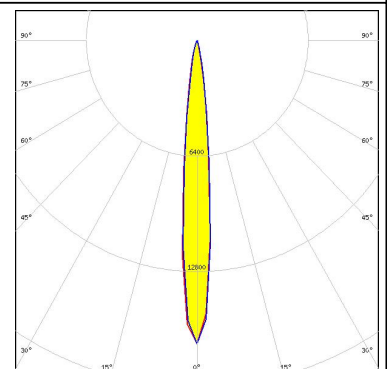

PHOTOMETRIC DATA (MEASURED):

OSRAM
Opto Semiconductors

LED	OSLON Square EC
FWHM	9.0°
Efficiency	91 %
Peak intensity	21.000 cd/m
LEDs/each optic	1
Light colour	White
Required components:	

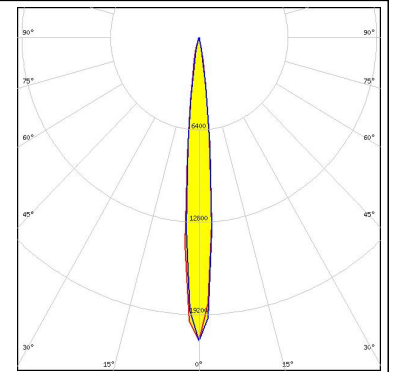

PHOTOMETRIC DATA (SIMULATED):



LED XP-E
 FWHM 8.0°
 Efficiency 95 %
 Peak intensity 34.668 cd/lm
 LEDs/each optic 1
 Light colour White
 Required components:

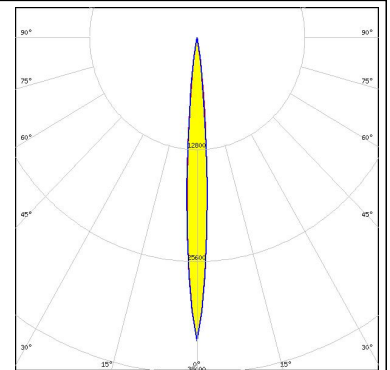

LED NCSxx19A
 FWHM 8.0°
 Efficiency 94 %
 Peak intensity 31.499 cd/lm
 LEDs/each optic 1
 Light colour White
 Required components:

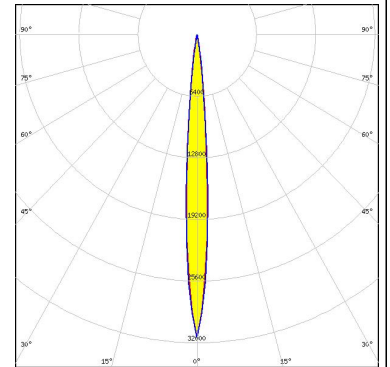

LED OSOLON SSL 150
 FWHM 9.0°
 Efficiency 96 %
 Peak intensity 25.647 cd/lm
 LEDs/each optic 1
 Light colour White
 Required components:

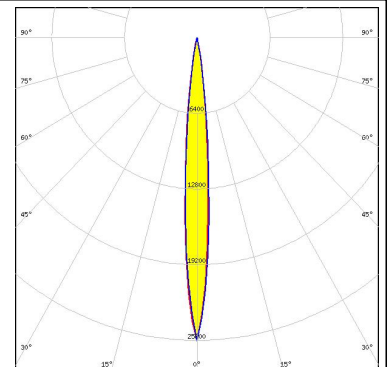

LED OSOLON SSL 80
 FWHM 8.0°
 Efficiency 95 %
 Peak intensity 32.453 cd/lm
 LEDs/each optic 1
 Light colour White
 Required components:

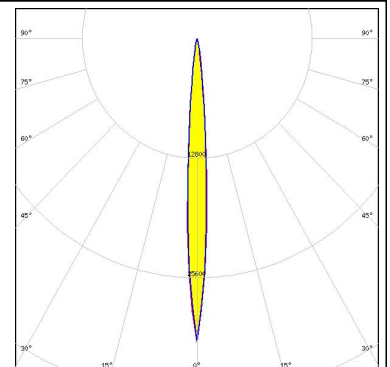

GENERAL INFORMATION:

NOTE: The typical beam angle will be changed by different color, chip size and chip position tolerance. The typical total beam angle is the full angle measured where the luminous intensity is half of the peak value.

MATERIALS:

As part of our continuous research and improvement processes, and to ensure the best possible quality and availability of our products, LEDiL reserves the right to change material grades without notice.

PRODUCT DATA USER AGREEMENT AND DISCLAIMER:

The measured data in the provided downloadable LEDiL Product Datasheets and Mechanical 2D-Drawings is rounded and provided as reference for planning. LEDiL Oy's optical specifications have been verified by conducting performance testing of the products in accordance with the company's quality system. The reported data are averaged results of multiple measurements with typical variation. LEDiL Oy reserves the right to without prior notification make changes and improvements to its products.

LEDiL Oy assumes neither warranty, nor guarantee nor any other liability of any kind for the contents and correctness of the provided data. The provided data has been generated with highest diligence but the provided data may in reality not represent the complete possible variation range of all intrinsic parameters. Therefore, in certain cases a deviation from the provided data could occur.

LEDiL Oy reserves the right to undertake technical changes of its products without further notification which could lead to changes in the provided data. LEDiL Oy assumes no liability of any kind for the possible deviation from any provided data or any other damage resulting from the usage of the provided data.

The user agrees to this disclaimer and user agreement with the download or usage of the provided files.

LEDiL Oy

Joensuunkatu 13
FI-24240 SALO
Finland

LEDiL Inc.

228 West Page Street
Suite D
Sycamore IL 60178
USA

Local sales and technical support

[www.ledil.com/
where_to_buy](http://www.ledil.com/where_to_buy)

Shipping locations

Salo, Finland
Hong Kong, China

Distribution Partners

[www.ledil.com/
where_to_buy](http://www.ledil.com/where_to_buy)