

Automotive 2xLTE MIMO + GNSS + AM/FM Sharkfin Antenna



AECS1806D07Z

Request Samples



Check Inventory



181.7 x 69.1 x 68.9 mm
RoHS/RoHS II Compliant
MSL Level = 1

Features

- 4 Cabled Combo Antenna
 - MIMO 2xLTE
 - 1x Active GNSS/GPS/GLONASS/BeiDou/QZSS
 - 1x AM/FM
- Manufactured in Automotive Certified lines
 - IATF 16949 certified
 - ISO 9001 certified
- Level-3 PPAP available on request
- IP67 rated
- Easy installation using Screw
- Customizable cable & connector options for RF connection

Applications

- IoT
- M2M
- Telematics
- Transportation
- Smart Agriculture
- Geolocation and tracking

Product Image



Automotive 2xLTE MIMO + GNSS + AM/FM Sharkfin Antenna



AECS1806D07Z

Request Samples



Check Inventory



181.7 x 69.1 x 68.9 mm
RoHS/RoHS II Compliant
MSL Level = 1

Part Number Builder

AECS1806D07Z -

Color / UV Coating	
Code	Description
S (Standard)	Black without UV coating
A	Black with UV Coating
B	White without UV Coating
C	White with UV Coating

Cable length in 'mm'	
Code	Description
3000 (Standard)	3000 mm
Other Examples :	
0200	200 mm
2000	2000 mm

Cable Type & Connector Type				
Code	Cable Type	Connector Type		
		LTE MIMO	GNSS	AMFM
S (Standard)	RG-174	SMA (M)	SMA (M)	FME (M)
A		SMA (M)	SMA (M)	SMA (M)
B		SMA (M)	SMA (M)	DIN (M)
C		SMA (M)	FAKRA C (F)	SMA(M)
D		SMA (M)	FAKRA C (F)	FME (M)
E		SMA (M)	FAKRA C (F)	DIN (M)
F		FAKRA D (F)	SMA (M)	SMA(M)
G		FAKRA D (F)	SMA (M)	FME (M)
H		FAKRA D (F)	SMA (M)	DIN (M)
I		FAKRA D (F)	FAKRA C (F)	SMA (M)
J		FAKRA D (F)	FAKRA C (F)	FME (M)
K		FAKRA D (F)	FAKRA C (F)	DIN (M)
L		SMA (M)	SMA (M)	SMA (M)
M		SMA (M)	SMA (M)	FME (M)
N	SMA (M)	SMA (M)	DIN (M)	
O	SMA (M)	FAKRA C (F)	SMA(M)	
P	SMA (M)	FAKRA C (F)	FME (M)	
Q	SMA (M)	FAKRA C (F)	DIN (M)	
R	LMR-100	FAKRA D (F)	SMA (M)	SMA(M)
T		FAKRA D (F)	SMA (M)	FME (M)
U		FAKRA D (F)	SMA (M)	DIN (M)
V		FAKRA D (F)	FAKRA C (F)	SMA (M)
W		FAKRA D (F)	FAKRA C (F)	FME (M)
X		FAKRA D (F)	FAKRA C (F)	DIN (M)

Example Configurations :

Part Number	UV Protection Coating / Color	Cable length	Cable Type / Connector Type
AECS1806D07Z S-3000S	Yes / Black	3000 mm	4xRG-174 with 2xSMA (M) for LTE MIMO + 1xGNSS + 1xFME (M) for AM/FM (Standard)
AECS1806D07Z A-1000A	Yes / Black	1000 mm	4xRG-174 with 2xSMA (M) for LTE MIMO + 1xSMA (M) for GNSS + 1xSMA (M) for AM/FM
AECS1806D07Z B-5000X	No / White	5000 mm	4xLMR-100 with 2xFAKRA D (F) for LTE MIMO + 1xFAKRA C (F) for GNSS + 1xDIN (M) for AM/FM

Note :

- For the standard part number (AECS1806D07Z**S-3000S**), please refer to the packaging at the end of the document.
- For additional configuration (AECS1806D07Z-), MOQs, pricing and packaging changes may be applicable.



5101 Hidden Creek Ln Spicewood TX 78669
 Phone: 512-371-6159 | Fax: 512-351-8858
 For terms and conditions of sales, please visit:
www.abracon.com

REVISED: 05-08-20

ABRACON IS
 ISO9001-2015
 CERTIFIED

Automotive 2xLTE MIMO + GNSS + AM/FM Sharkfin Antenna



AECS1806D07Z

Request Samples



Check Inventory



181.7 x 69.1 x 68.9 mm
RoHS/RoHS II Compliant
MSL Level = 1

Electrical Specification

Parameter	Specification			Unit
	Min	Typ	Max	
GNSS Antenna				
Operating Frequency	1561		1602	MHz
Gain (Zenith)			2.0	dBiC
VSWR			1.5	
Impedance		50		Ω
Polarization	RHCP			
LNA				
Noise Figure			2.0	dB
Gain	26	28	30	dB
VSWR			2.0	
Supply Voltage	3.0		5.0	V
Current Consumption	5.0		15.0	mA
LTE Antenna (Main)				
Operating Frequency	698		960	MHz
	1710		2690	
VSWR			3.0	
Gain (Zenith)			3.5	dBi
Impedance		50		Ω
Polarization	Linear			
LTE Antenna (Aux)				
Operating Frequency	698		960	MHz
	1710		2690	
VSWR			3.0	
Gain (Zenith)			3.0	dBi
Impedance		50		Ω
Polarization	Linear			
FM/AM Antenna				
Operating Frequency	0.529		1.629	MHz
	76		108	
VSWR			2.5	
Peak Gain	FM	13	16	dB
	AM	2	5	
Impedance		50		Ω
Polarization	Linear			
Supply Voltage (DC)	9		16	V

Automotive 2xLTE MIMO + GNSS + AM/FM Sharkfin Antenna



AECS1806D07Z

Request Samples



Check Inventory



181.7 x 69.1 x 68.9 mm
RoHS/RoHS II Compliant
MSL Level = 1

Mechanical Specification

Parameter	Specification
Antenna Dimension	181.7 x 69.1 x 68.9 mm
Mounting Type	Screw
RF Connector	3x SMA (M) + 1x FME (M)
RF Cable	4x RG174
Cable Length	3 m
Material	PC + ABS

Environmental Specification

Parameter	Specification
Operating Temperature	-40°C to +85°C
Storage Temperature	-40°C to +85°C
Relative Humidity	Up to 95%
RoHS Compliance	Yes
PB Free	Yes
MSL	1
ESD Sensitive	Yes
Vibration	10~1000 Hz G =28.7m/s ²
Ingress Protection	IP67 (excluding cable outlet)

Automotive 2xLTE MIMO + GNSS + AM/FM Sharkfin Antenna



AECS1806D07Z

Request Samples



Check Inventory



181.7 x 69.1 x 68.9 mm
RoHS/RoHS II Compliant
MSL Level = 1

Product Dimension

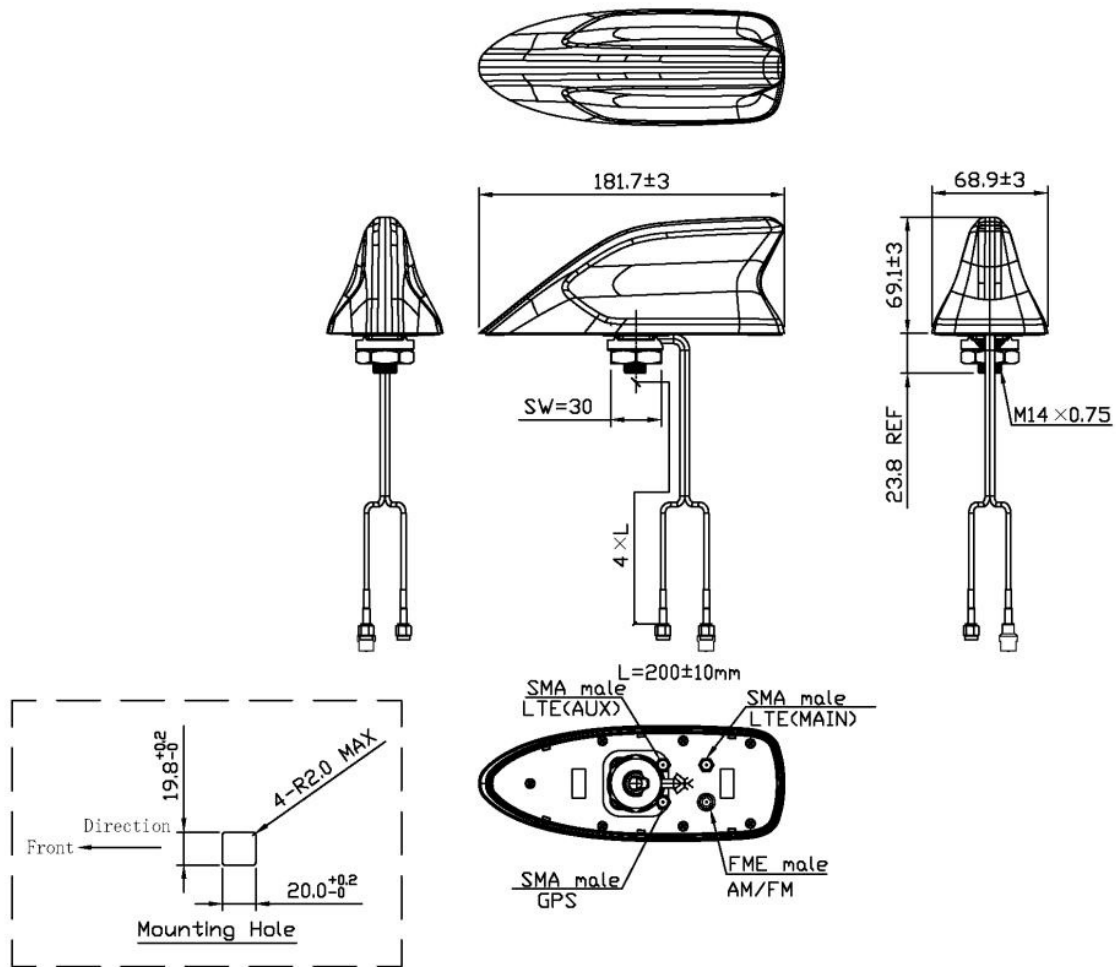

Unit : mm

Automotive 2xLTE MIMO + GNSS + AM/FM Sharkfin Antenna



AECS1806D07Z

Request Samples



Check Inventory



181.7 x 69.1 x 68.9 mm
RoHS/RoHS II Compliant
MSL Level = 1

Test Measurement - VSWR

GNSS

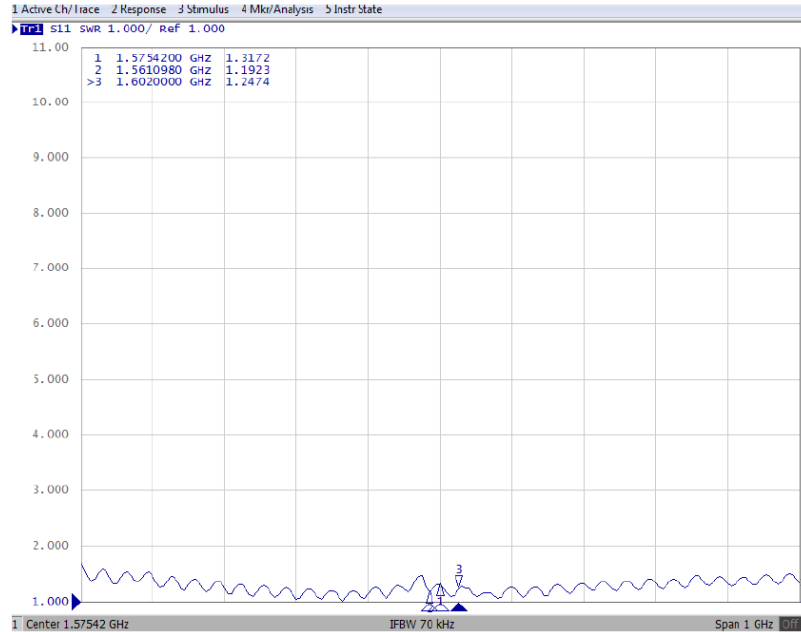

LTE

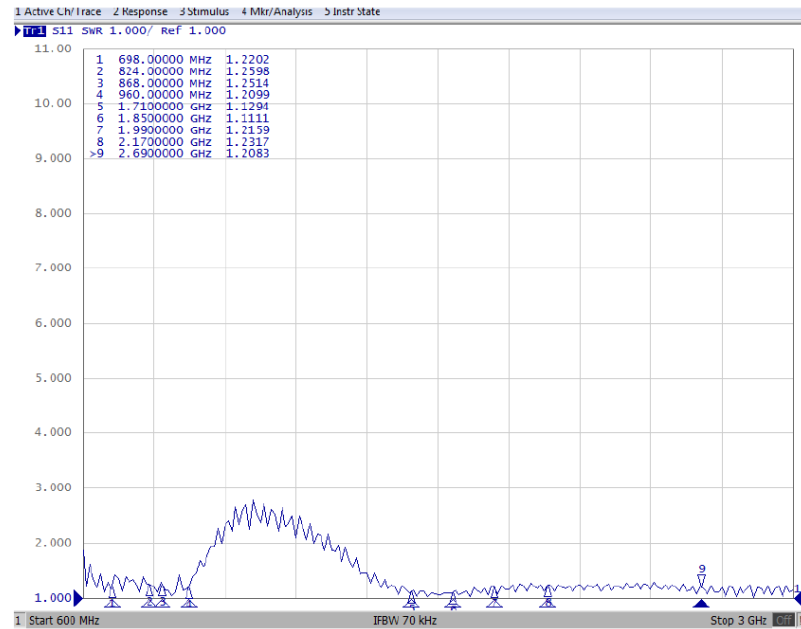

5101 Hidden Creek Ln Spicewood TX 78669
Phone: 512-371-6159 | Fax: 512-351-8858
For terms and conditions of sales, please visit:
www.abracon.com

REVISED: 05-08-20

ABRACON IS
ISO9001-2015
CERTIFIED

Automotive 2xLTE MIMO + GNSS + AM/FM Sharkfin Antenna



AECS1806D07Z

Request Samples



Check Inventory



181.7 x 69.1 x 68.9 mm
RoHS/RoHS II Compliant
MSL Level = 1

FM

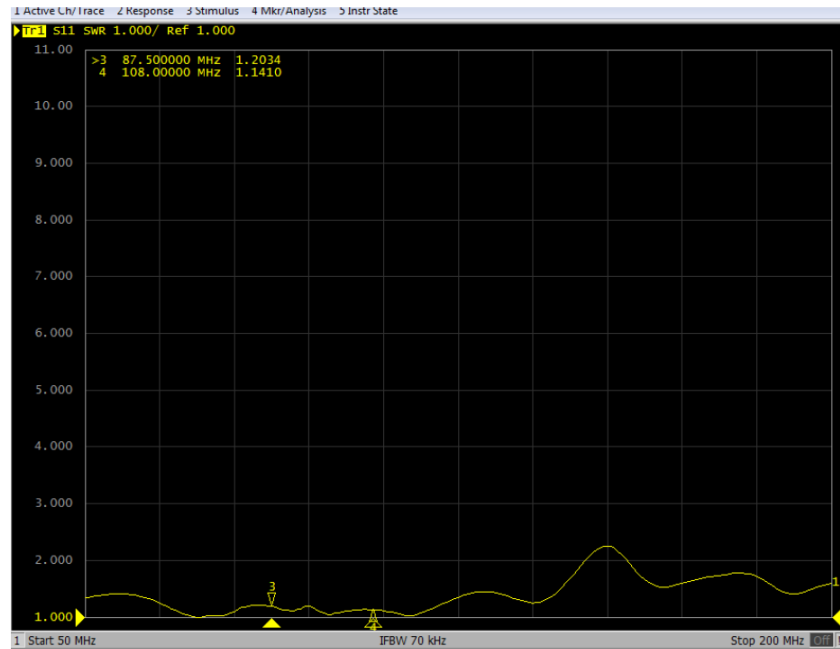

Radiation Characteristics

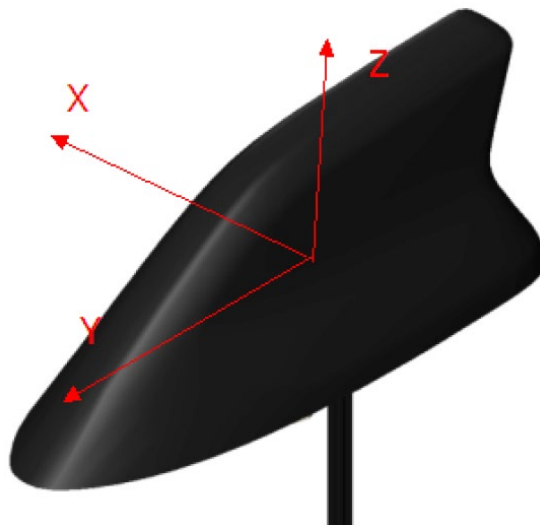

Automotive 2xLTE MIMO + GNSS + AM/FM Sharkfin Antenna



AECS1806D07Z

Request Samples



Check Inventory



181.7 x 69.1 x 68.9 mm
RoHS/RoHS II Compliant
MSL Level = 1

2D Pattern

GNSS Antenna

XY - Plane

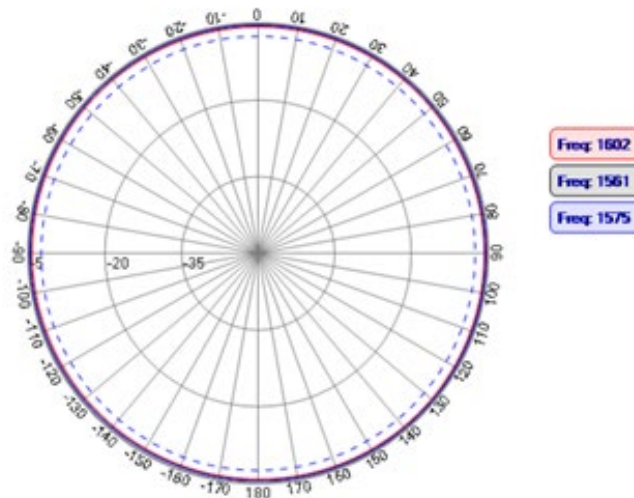

XZ - Plane

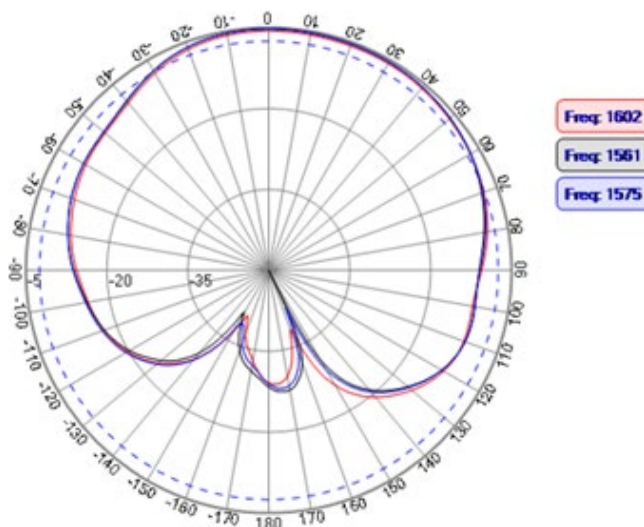

YZ - Plane

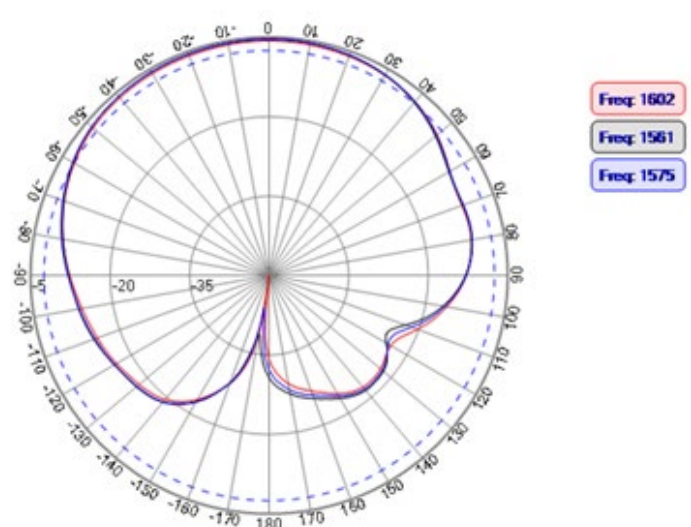

5101 Hidden Creek Ln Spicewood TX 78669
Phone: 512-371-6159 | Fax: 512-351-8858
For terms and conditions of sales, please visit:
www.abracon.com

REVISED: 05-08-20

ABRACON IS
ISO9001-2015
CERTIFIED

Automotive 2xLTE MIMO + GNSS + AM/FM Sharkfin Antenna



AECS1806D07Z

Request Samples



Check Inventory



181.7 x 69.1 x 68.9 mm
RoHS/RoHS II Compliant
MSL Level = 1

MIMO 2x LTE : Main and Aux

XY – Plane

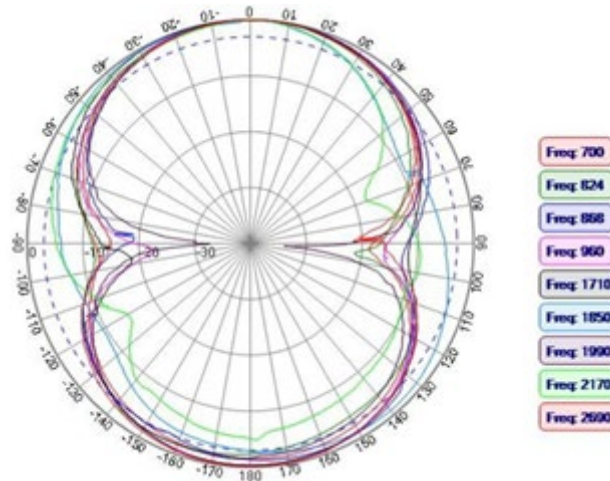

XZ - Plane

YZ – Plane

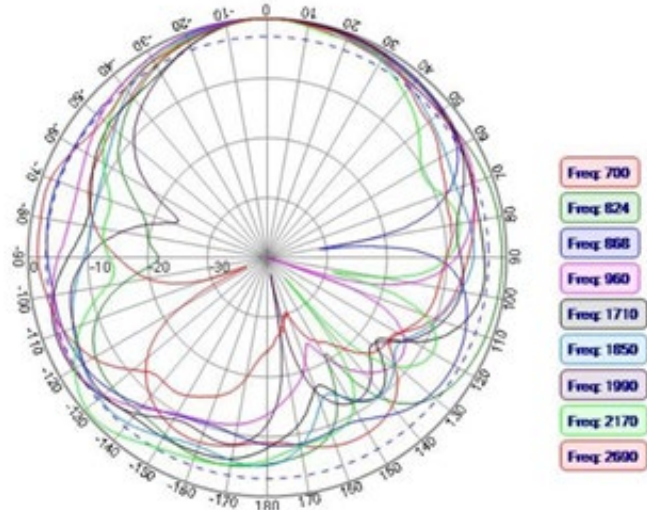
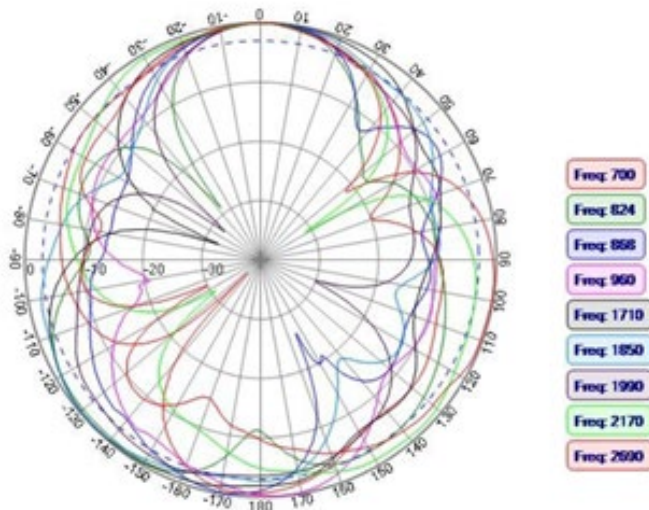

5101 Hidden Creek Ln Spicewood TX 78669
Phone: 512-371-6159 | Fax: 512-351-8858
For terms and conditions of sales, please visit:
www.abracon.com

REVISED: 05-08-20

ABRACON IS
ISO9001-2015
CERTIFIED

Automotive 2xLTE MIMO + GNSS + AM/FM Sharkfin Antenna



AECS1806D07Z

Request Samples



Check Inventory



181.7 x 69.1 x 68.9 mm
RoHS/RoHS II Compliant
MSL Level = 1

3D Pattern

MIMO 2x LTE : Main and Aux

698 MHz

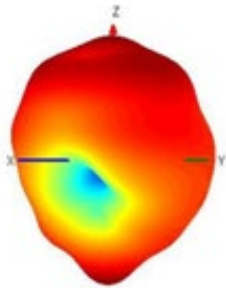

824 MHz

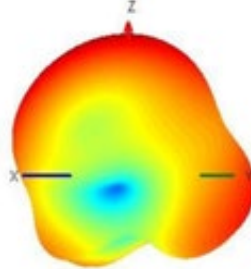

868 MHz

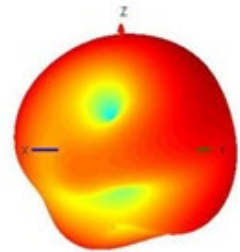

960 MHz

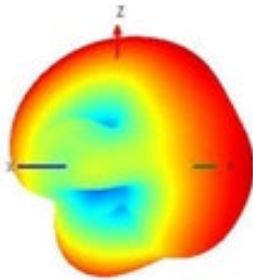

1710 MHz

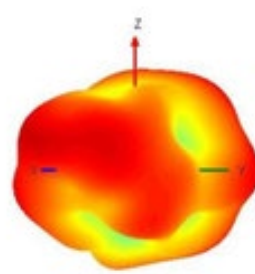

1850 MHz

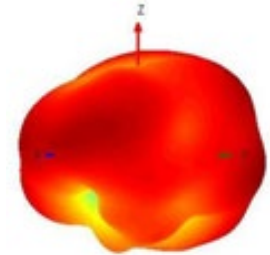

1990 MHz

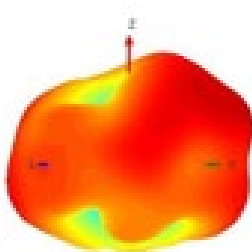

2170 MHz

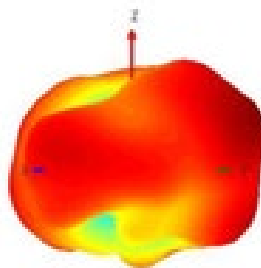

2690 MHz

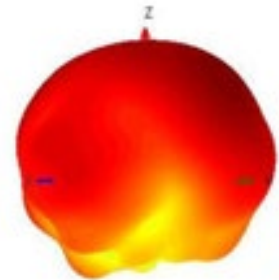

Automotive 2xLTE MIMO + GNSS + AM/FM Sharkfin Antenna



AECS1806D07Z

Request Samples



Check Inventory



181.7 x 69.1 x 68.9 mm
RoHS/RoHS II Compliant
MSL Level = 1

Gain and Efficiency

Frequency (MHz)	Gain (dBi)	Efficiency
698	3.47	0.68
824	2.29	0.59
868	1.92	0.57
960	2.2	0.56
1710	1.23	0.57
1850	0.65	0.54
1990	0.57	0.56
2170	1.91	0.59
2690	0.88	0.58

Packaging Information

Number of Antenna/ Carton : 12 pcs
Weight of 1 pc of antenna : 500 g
Size of the carton : 495 x 220 x 270 mm
Weight of the carton : 7 kg

ATTENTION: Abracon LLC's products are COTS – Commercial-Off-The-Shelf products; suitable for Commercial, Industrial and, where designated, Automotive Applications. Abracon's products are not specifically designed for Military, Aviation, Aerospace, Life-dependent Medical applications or any application requiring high reliability where component failure could result in loss of life and/or property. For applications requiring high reliability and/or presenting an extreme operating environment, written consent and authorization from Abracon LLC is required. Please contact Abracon LLC for more information.



5101 Hidden Creek Ln Spicewood TX 78669
Phone: 512-371-6159 | Fax: 512-351-8858
For terms and conditions of sales, please visit:
www.abracon.com

REVISED: 05-08-20

ABRACON IS
ISO9001-2015
CERTIFIED