

## DETAILS

<b>Product Number</b>	FCN13929_BARBARA-WW-PF-VERO13/18
<b>Family</b>	Barbara
<b>Type</b>	RefPack
<b>Color</b>	metal
<b>Diameter</b>	70 mm
<b>Height</b>	41,7 mm
<b>Style</b>	round
<b>Optic Material</b>	PC
<b>Holder Material</b>	
<b>Fastening</b>	
<b>Status</b>	production ready
<b>ROHS Compliant</b>	Yes
<b>Date Updated</b>	11/09/2015



## OPTICAL PROPERTIES

LED	Viewing Angle	Light Beam	Efficiency	cd/lm	Connector
CXM-14	sim: 50	Very Wide	sim: 86 %	sim: 1.300	Bender Wirth: 433 Typ L1
ZC12/18	sim: 50	Very Wide	sim: 86 %	sim: 1.300	Bender Wirth: 433 Typ L1
CXM-9	sim: 43	Very Wide	sim: 88 %	sim: 1.600	Bender Wirth: 434 Typ L1
ZC4/6	sim: 43	Very Wide	sim: 88 %	sim: 1.600	Bender Wirth: 434 Typ L1
CLU700	28 deg	Very Wide	88 %	2.100	Bender Wirth: 434 Typ L1
LUXEON CoB 1202/1203	39 deg	Very Wide	88 %	1.700	Bender Wirth: 438 Typ L1
NSBxL066A/NFCxL036B	41 deg	Very Wide	89 %	1.700	Bender Wirth: 438 Typ L1
CXA/B 15xx	41 deg	Very Wide	87 %	1.700	Bender Wirth: 441 Typ L1
Solieriq P9	43 deg	Very Wide	90 %	1.700	Bender Wirth: 461 Typ L1
CLL02x/CLU02x (LES10)	43 deg	Very Wide	88 %	1.600	Bender Wirth: 434 Typ L1
CLU720	43 deg	Very Wide	86 %	sim: 1.600	Bender Wirth: 433 Typ L1
SLE G5 LES11	43 deg	Very Wide	89 %	1.600	Bender Wirth: 434 Typ L1
CXA/B 1816 & CXA/B 1820 & CXA 1850	46 deg	Very Wide	86 %	1.400	Bender Wirth: 437 Typ L1
L121A/L060B/L024Z	46 deg	Very Wide	87 %	1.500	Bender Wirth: 438 Typ L1
Solieriq S13	47 deg	Very Wide	87 %	1.400	Bender Wirth: 437 Typ L1
Solieriq P13	48 deg	Very Wide	88 %	1.400	Bender Wirth: 437 Typ L1
CLL03x/CLU03x	50 deg	Very Wide	86 %	1.300	Bender Wirth: 433 Typ L1
VERO13	51 deg	Very Wide	90 %	1.400	-
V15	51 deg	Very Wide	86 %	1.390	Bender Wirth: 456 Typ L2
J216A/J130B/J108B/J048Z	51 deg	Very Wide	86 %	1.300	Bender Wirth: 463 Typ L2
LC026B/LC040B	55 deg	Very Wide	86 %	1.100	Bender Wirth: 450 Typ L2
VERO18	58 deg	Very Wide	91 %	1.170	-

Relative intensity of FCN13929\_BARBARA-WW-PF-VERO13\_18\_(V15)

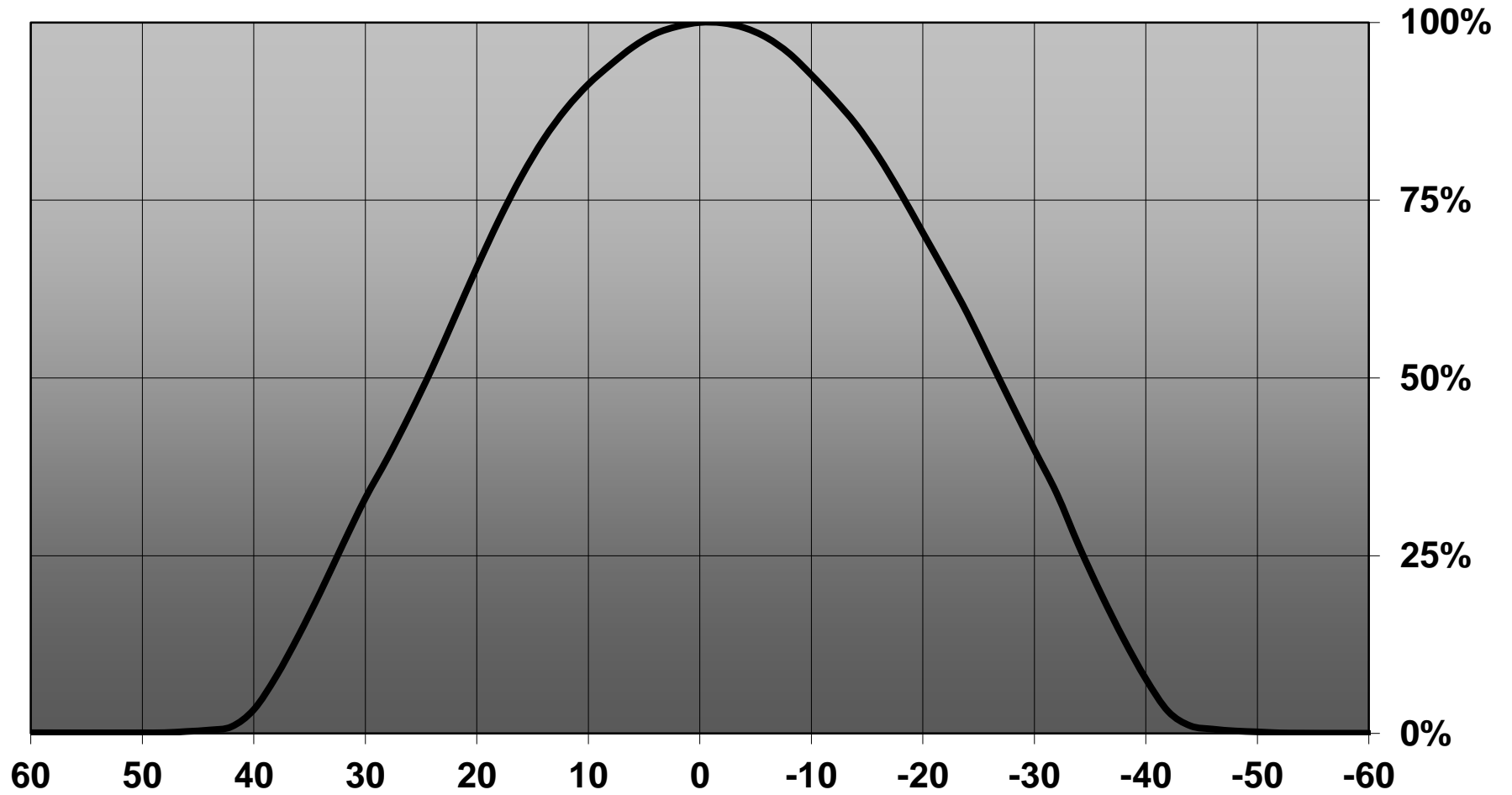

H G F E D C B A

4

3

2

1

4

3

2

1

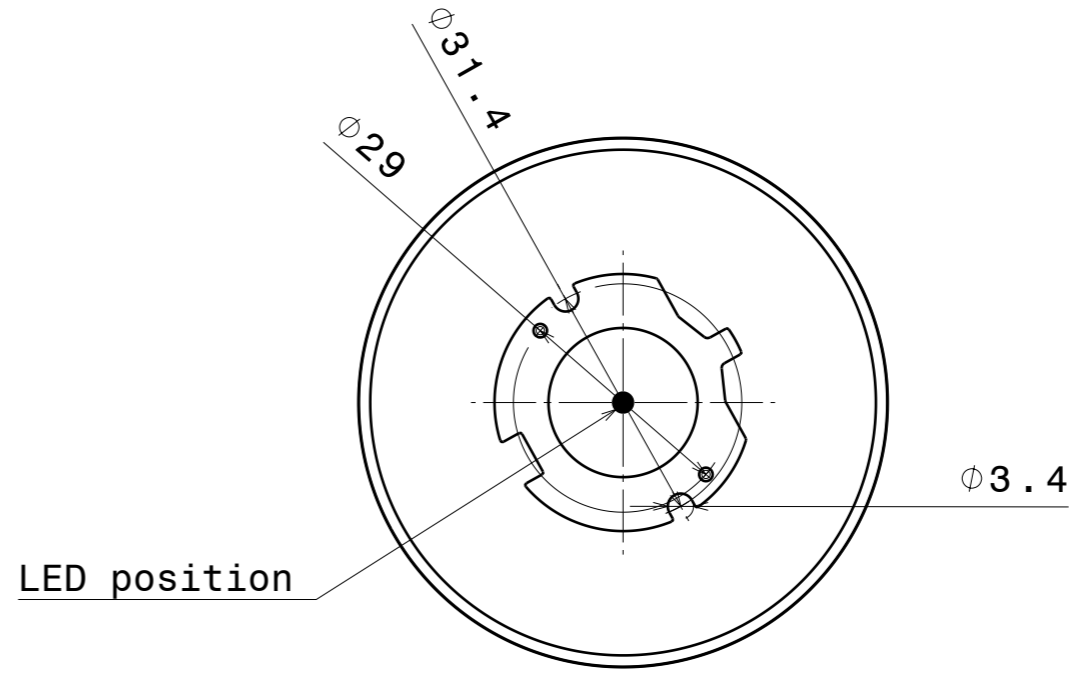
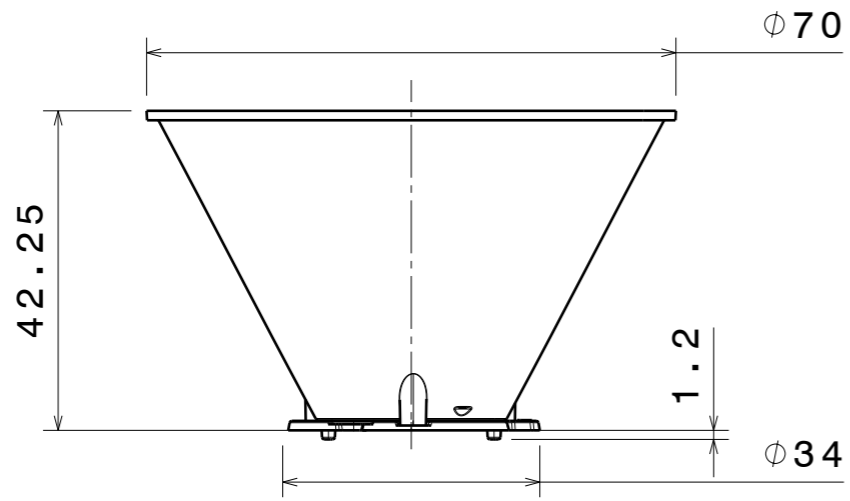

LED position

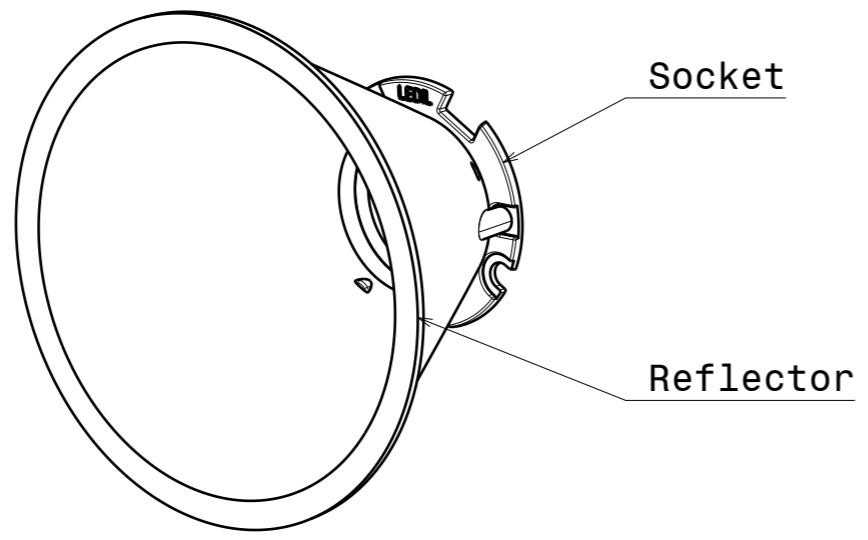

Socket

Reflector

INDEX	PART NO	MATERIAL	COLOUR
1	Socket	PC	White
2	Reflector	PC	Metal

Tolerances if not otherwise shown  
 According to DIN ISO 2768-1  
 Linear measures: class C  
 According to DIN ISO 2768-2  
 Form and position: class L

**LEDiL** LediL Oy  
 Salorankatu 10  
 FIN 24240 SALO  
 Finland

THIRD ANGLE PROJECTION:

DRAWING TITLE **DATA SHEET BARBARA-PF SOCKET-VERO13-18**

This drawing is the property of LEDiL Oy. It may not be reproduced, copied or communicated without a written agreement with LEDiL Oy.

SIZE **A3** PART NUMBER -

SCALE 1:1 WEIGHT - SHEET 1/1

H G B A

Luminaire: LEDiL Oy FCN13929\_BARBARA-WW-PF-VERO13-18\_(CLU700)

Lamps: 1 x Citizen\_CLU700\_(CLU700-1002B8-273M2G1)\_(C13709)\_(434\_Typ\_L1)\_374.62lm@100mA\_P=2.81352W\_I=0.1002A

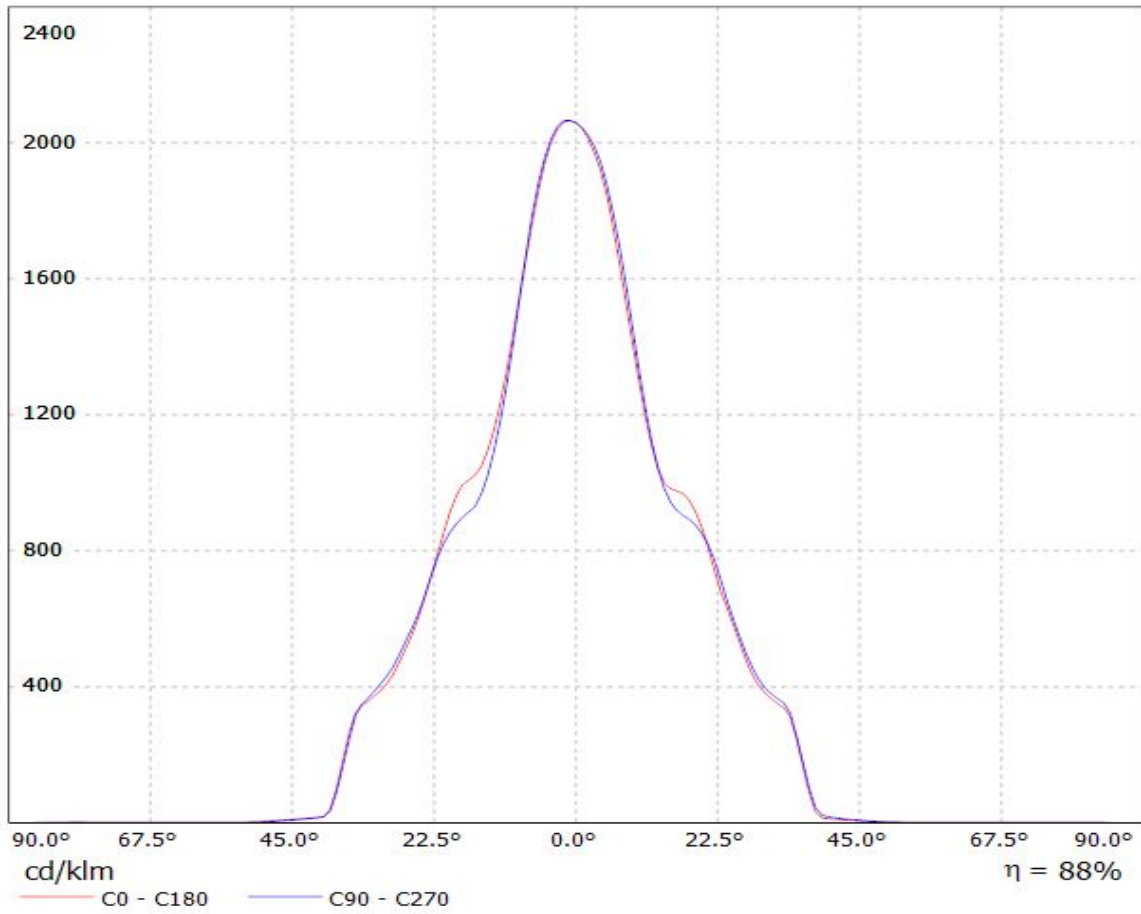

Luminaire: LEDiL Oy FCN13929\_BARBARA-WW-PF-VERO13-18\_(Luxeon CoB 1203)

Lamps: 1 x Luxeon\_COB\_1203\_(LHC1-3080-1203)\_(C13868\_LENA-STD-BASE-VERO13-18)\_(438\_Typ\_L1)\_990.381lm@250mA\_P=8.6818W\_I=0.2498A

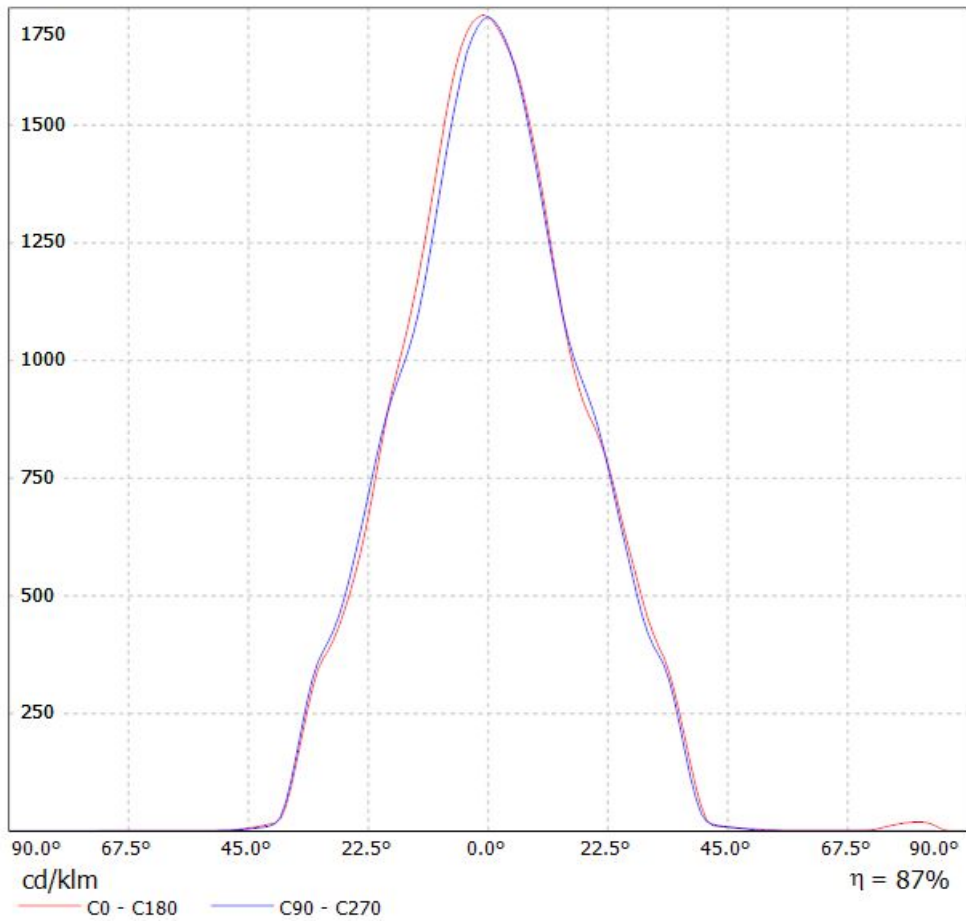

Luminaire: LEDiL Oy FCN13929\_BARBARA-WW-PF-VERO13-18\_(NFCLL036B)

Lamps: 1 x Nichia NFCLL036B (sm403J1300R8000)\_542.652lm@100mA\_CCT=4000K\_P=3.34084W\_I=0.100A

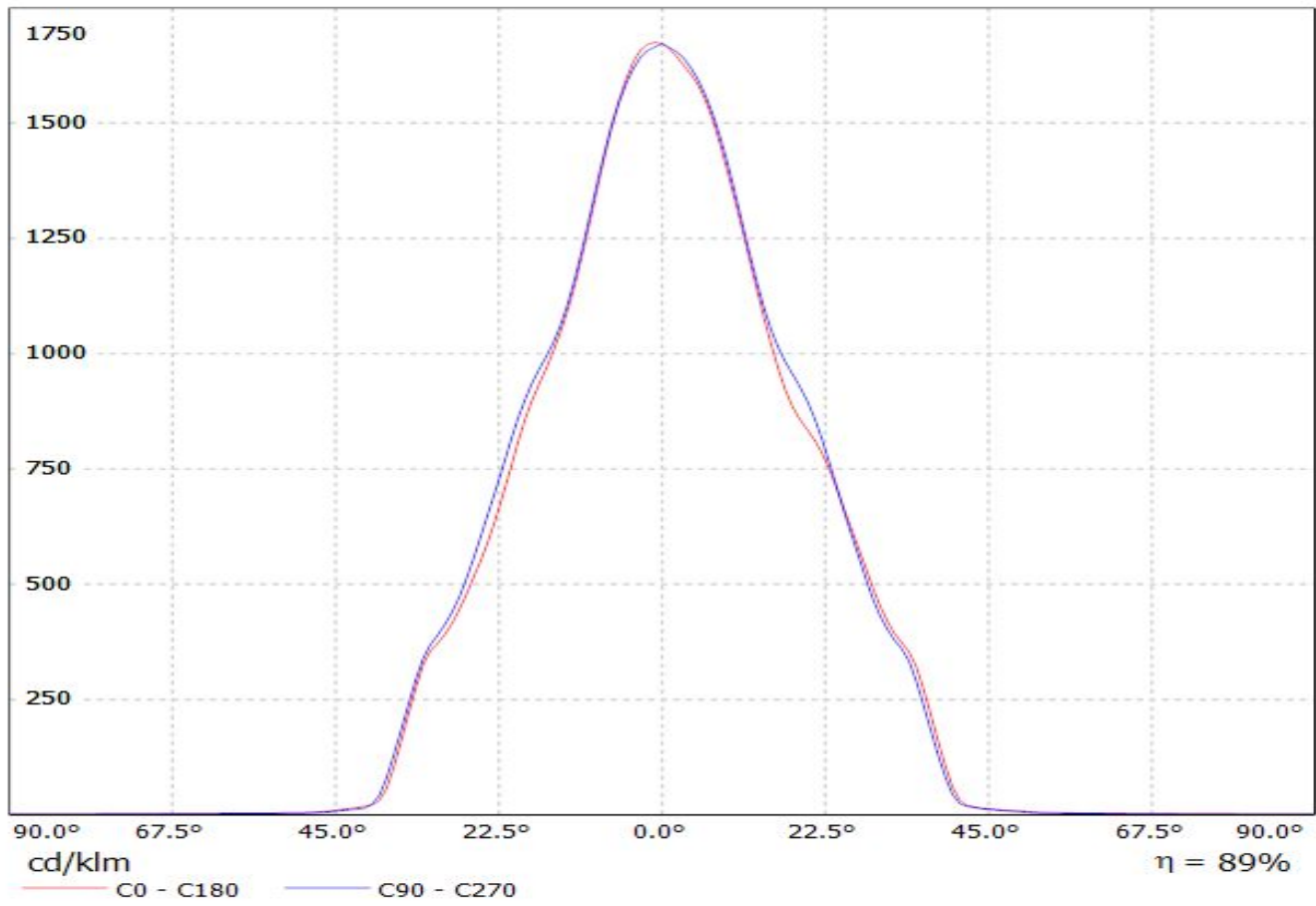

Luminaire: Ledil FCN13929\_BARBARA-WW-PF-VERO13-18\_(CXA1520) CXA1520\_(CXA1520-30F-N4-N0H-00001)\_(441\_Typ\_L1)\_(C13709\_PF-SOCKET-VERO13-18)\_1036.14lm@250mA\_P=8.825W\_I=0.25A  
Lamps: 1 x CXA1520\_(CXA1520-30F-N4-N0H-00001)\_(441\_Typ\_L1)\_(C13709\_PF-SOCKET-VERO13-18)\_1036.14lm@250mA\_P=8.825W\_I=0.25A

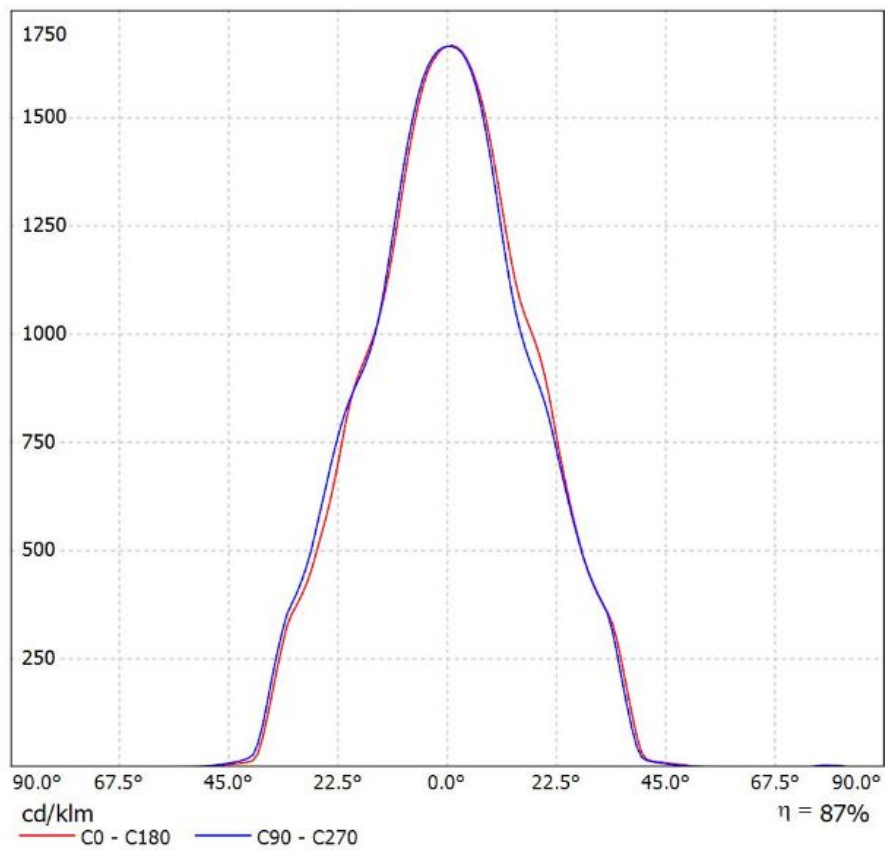

Luminaire: LEDiL Oy FCN13929\_BARBARA-WW-PF-VERO13/18\_(Soleriq\_P9)\_Bender+Wirth\_connector\_461  
Lamps: 1 x Osram\_Soleriq\_P9\_(GQ\_MAFJB1.EM)\_875.631lm@250mA\_P=6.94894W\_I=0.2498A

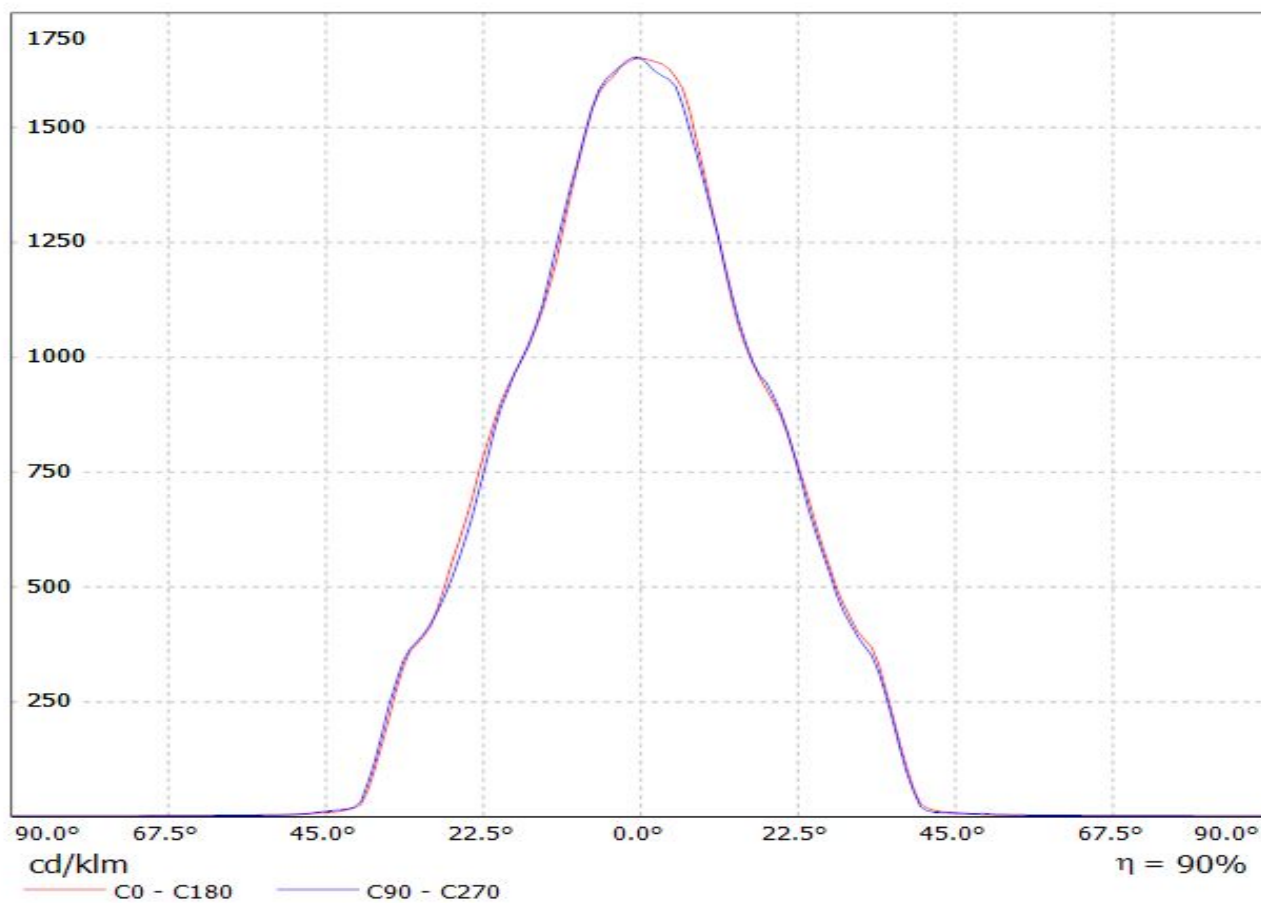



Luminaire: Ledil FCN13929\_BARBARA-WW-PF-VERO13/18\_(CLU024) Citizen\_CLU024\_(434\_Typ\_L1)\_  
(C13709\_PF-SOCKET-VERO13-18)\_1065.5lm@250mA\_P=8.55W\_I=0.25A  
Lamps: 1 x Citizen\_CLU024\_(434\_Typ\_L1)\_ (C13709\_PF-SOCKET-VERO13-18)  
\_1065.5lm@250mA\_P=8.55W\_I=0.25A

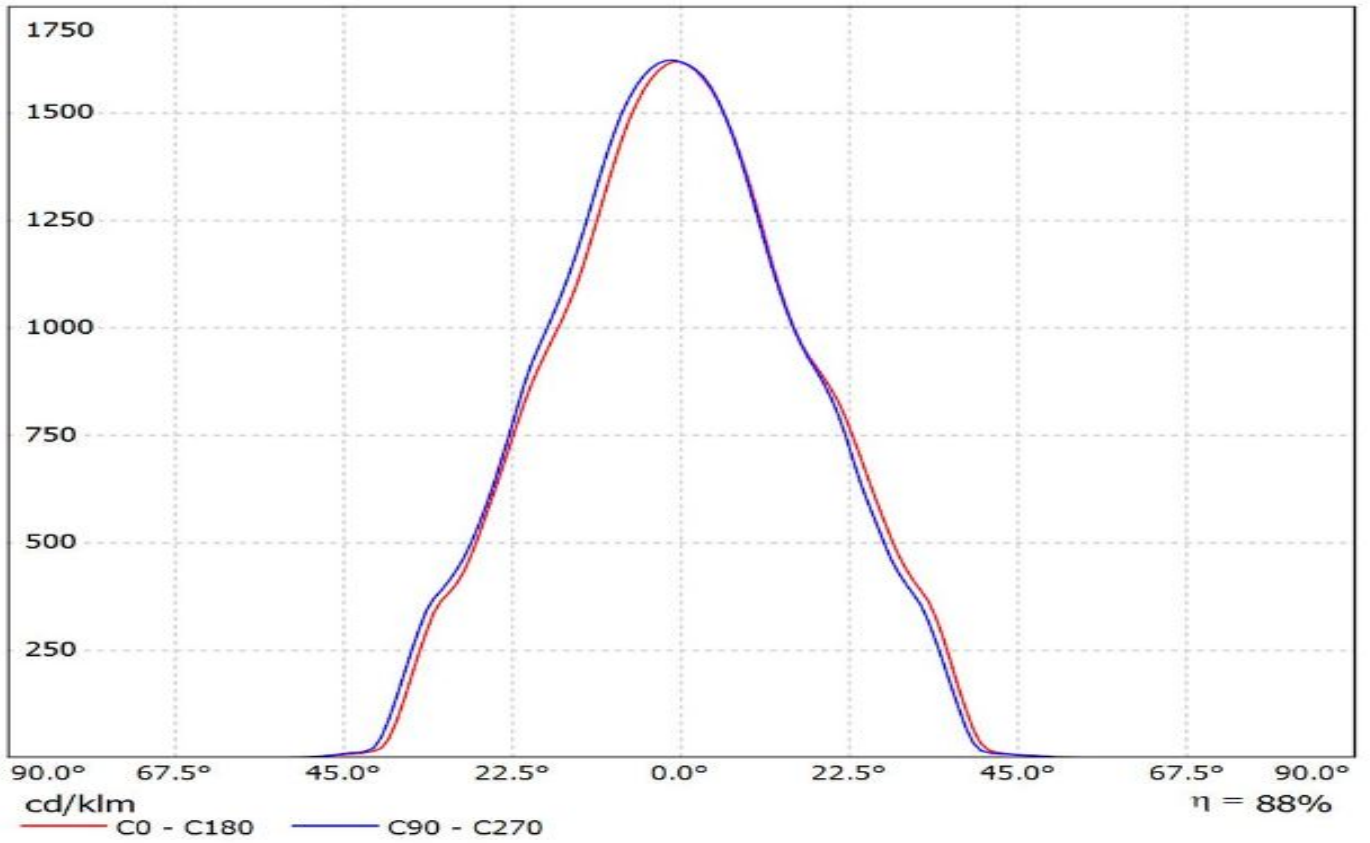

**Ledil FCN13929\_BARBARA-WW-PF-VERO13-18\_(CLU720)\_(433\_Typ\_L1) / LDC  
(Linear)**

Luminaire: Ledil FCN13929\_BARBARA-WW-PF-VERO13-18\_(CLU720)\_(433\_Typ\_L1)  
Lamps: 1 x Citizen\_CLU720\_(433\_Typ\_L1)\_(C13709\_PF-SOCKET-VERO13-18)  
\_1233.06lm@250mA\_P=8.3W\_I=0.25A

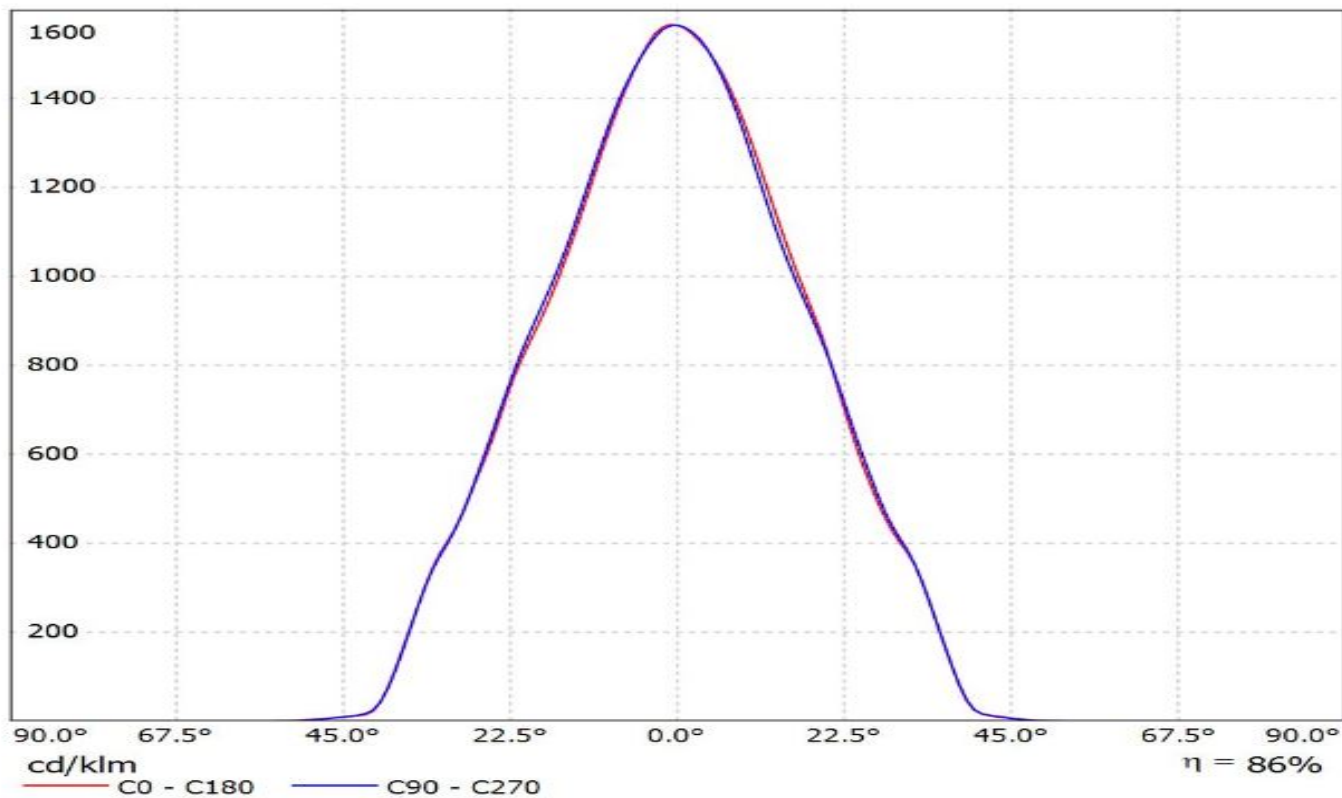

Luminaire: LEDiL Oy FCN13929\_BARBARA-WW-PF-VERO13/18\_(SLE-G5\_LES-11)  
Lamps: 1 x Tridonic\_SLE-G5\_LES-11\_1142.55lm@250mA\_P=8.4070W\_I=0.250A

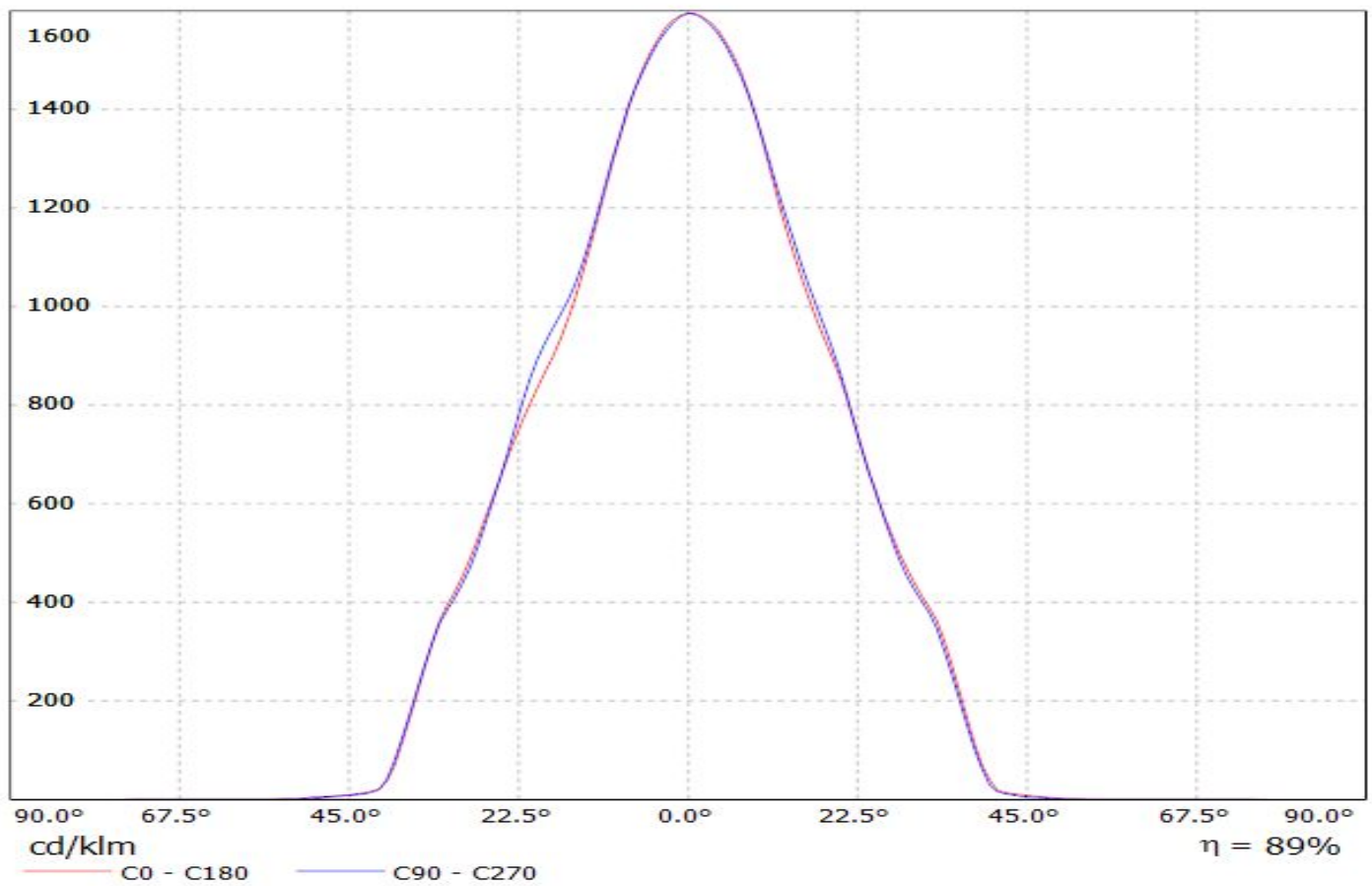

# Ledil FCN13929\_BARBARA-WW-PF-VERO13-18\_(CXA1850) / LDC (Linear)

Luminaire: Ledil FCN13929\_BARBARA-WW-PF-VERO13-18\_(CXA1850)

Lamps: 1 x CREE\_CXA1850\_(CXA1850-30F-T4-N0Y-00001)

\_847.836lm@250mA\_CCT=3000K\_P=8.27W\_I=0.25A

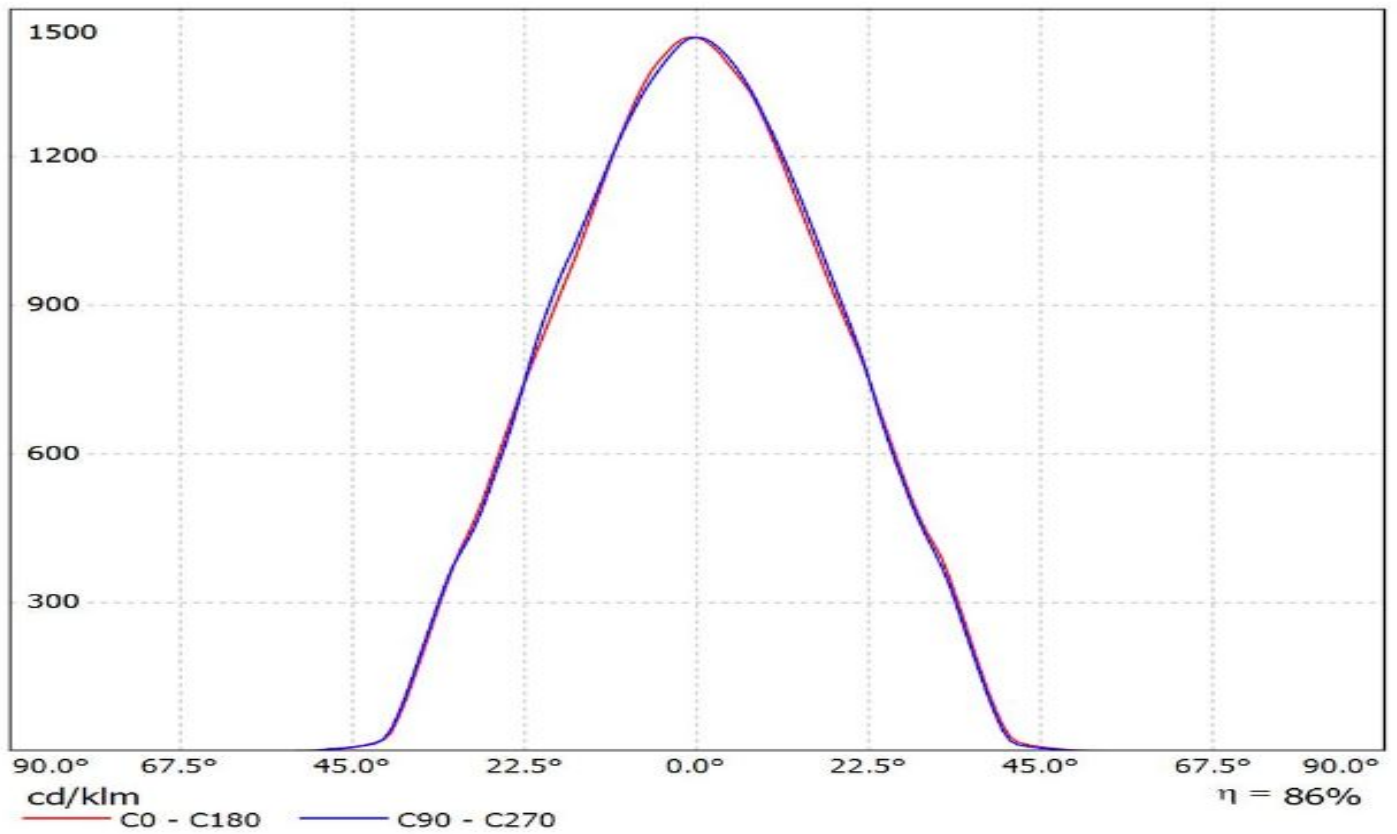

Luminaire: Ledil FCN13929\_BARBARA-WW-PF-VERO13/18\_(NFCLL060B)  
Lamps: 1 x Nichia\_NFCLL060B\_(438\_TYP\_L1)\_1365.88lm@250mA\_P=8.375W\_I=0.25A

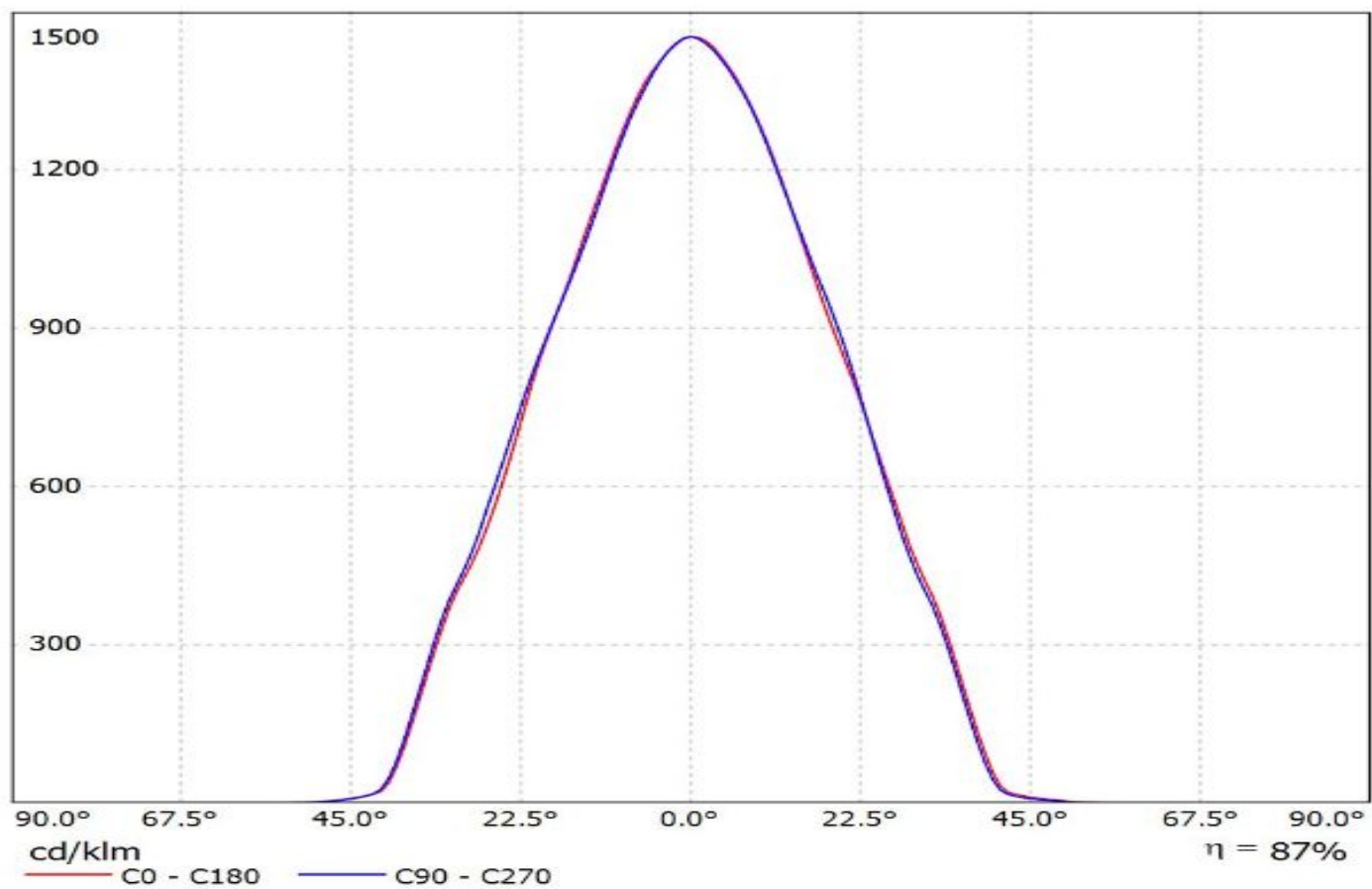

Luminaire: Ledil FCN13929\_BARBARA-WW-PF-VERO13-18\_(Soleriq\_S13)

Lamps: 1 x Osram\_Soleriq\_S13\_(GW\_KAGHB1.EM)\_931.029lm@250mA\_P=7.44679W\_I=250mA

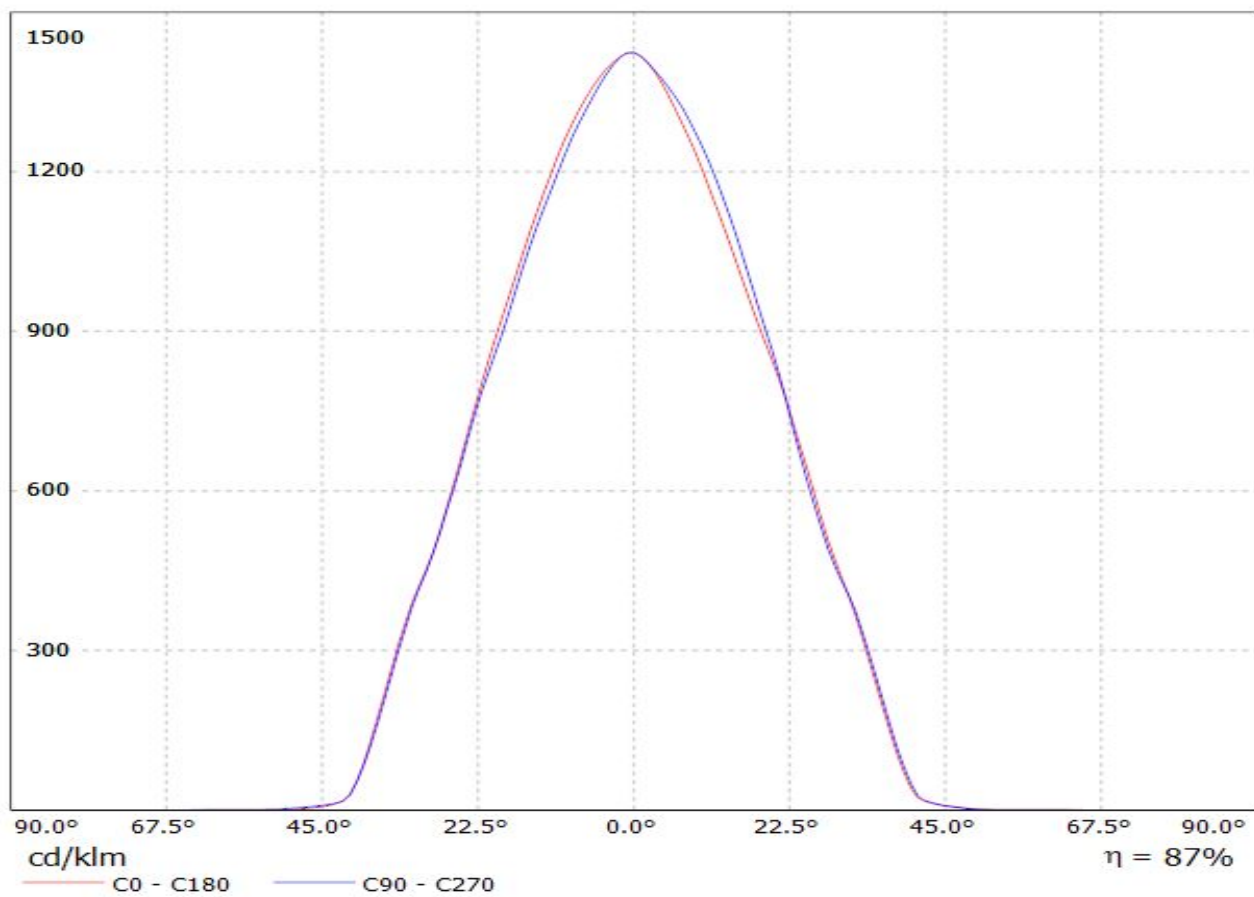

Luminaire: LEDiL Oy FCN13929\_BARBARA-WW-PF-VERO13/18\_(Soleriq P13)

Lamps: 1 x Osram Soleriq P13 (GW MAGMB1.EM)\_921.649lm@250mA\_CCT=3500K\_P=8.8097W\_I=0.25A

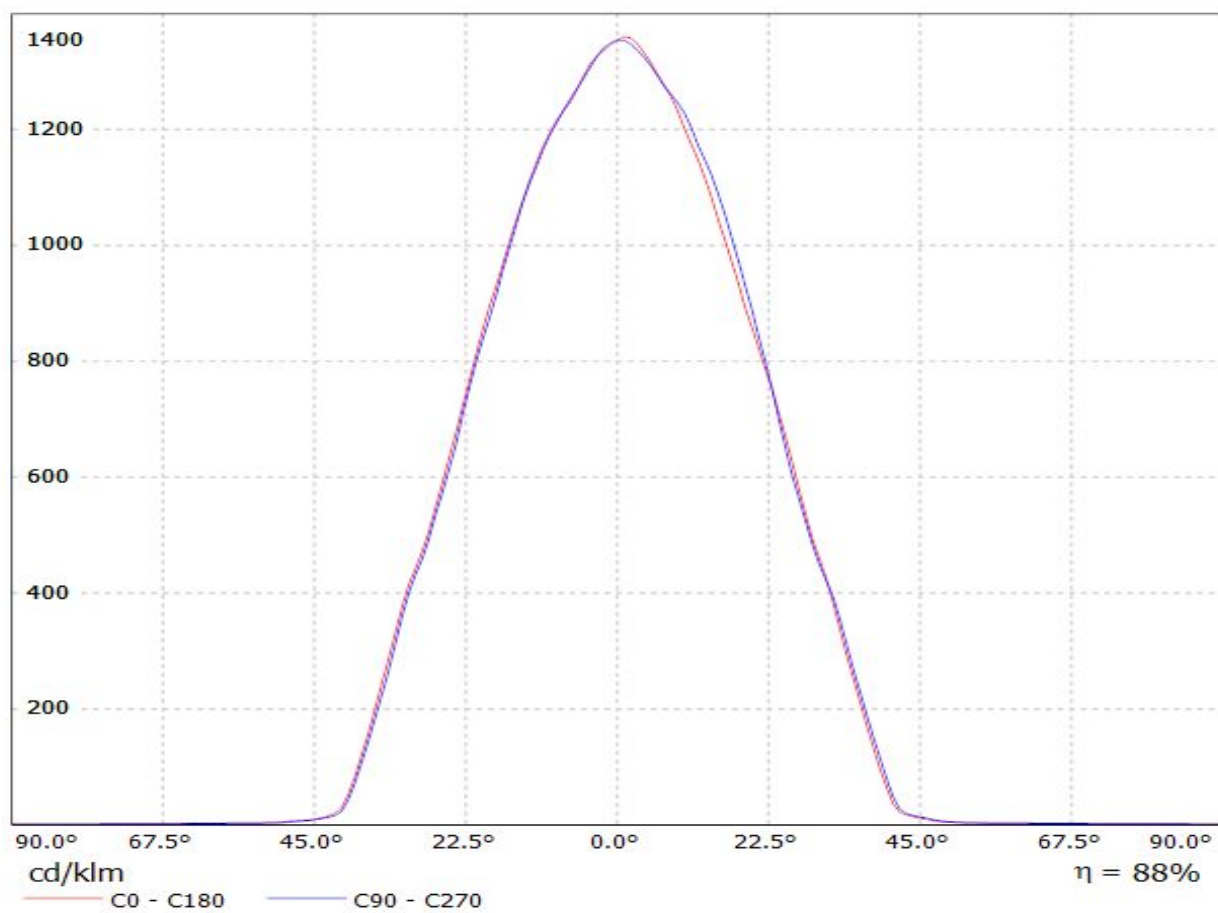

# Ledil FCN13929\_BARBARA-WW-PF-VERO13-18\_(CLU034)\_(433\_Typ\_L1) / LDC (Linear)

Luminaire: Ledil FCN13929\_BARBARA-WW-PF-VERO13-18\_(CLU034)\_(433\_Typ\_L1)

Lamps: 1 x Citizen\_CLU034\_(CLU034-1205B8-303M1A2)\_1180.79lm@250mA\_P=8.50075W\_I=0.25A

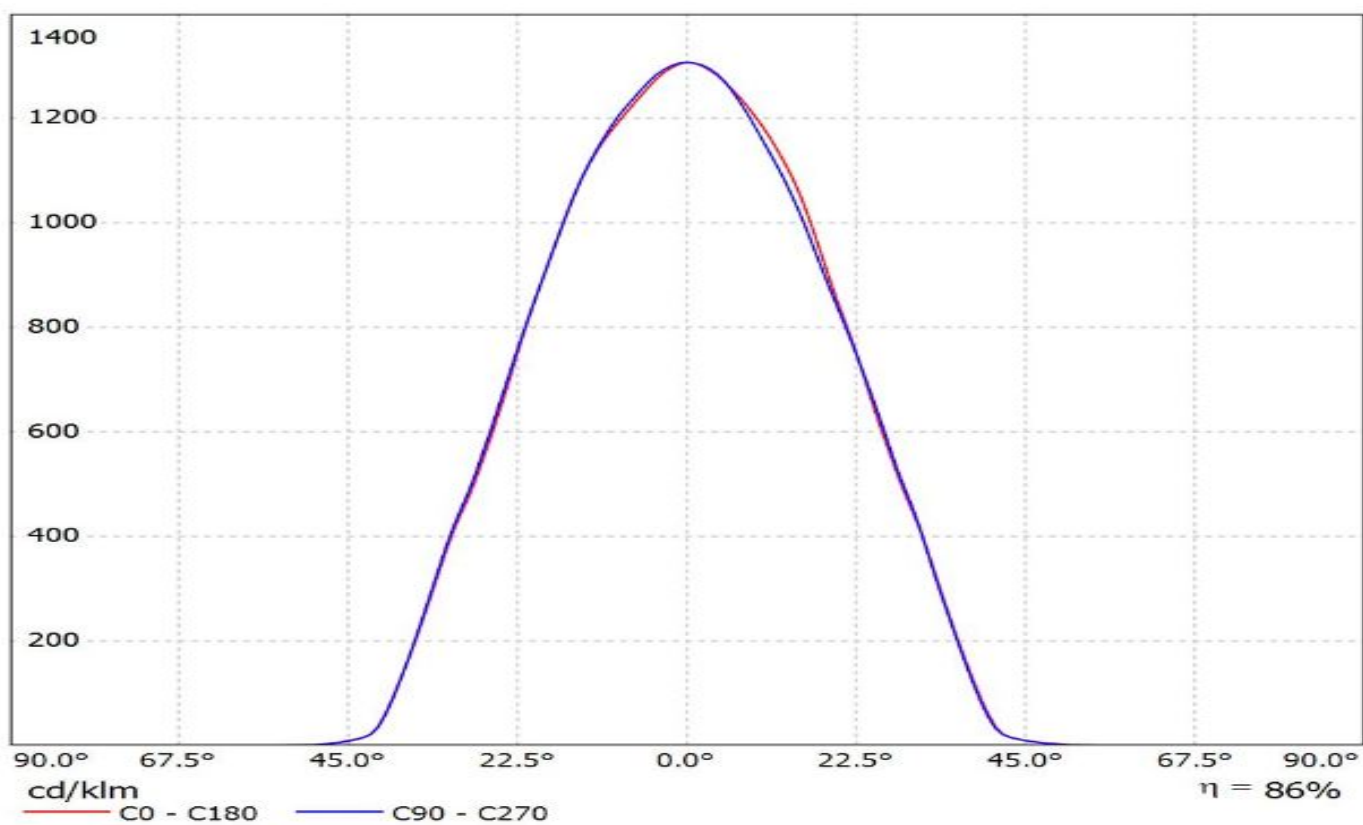



Luminaire: LEDil Oy FCN13929\_BARBARA-WW-PF-VERO1318\_(VERO13) Efficiency=90%  
Lamps: 1 x Bridgelux (BXRC-40E2000C) 1025lm @ 250mA CCT=4000K P=7.7W I=250mA

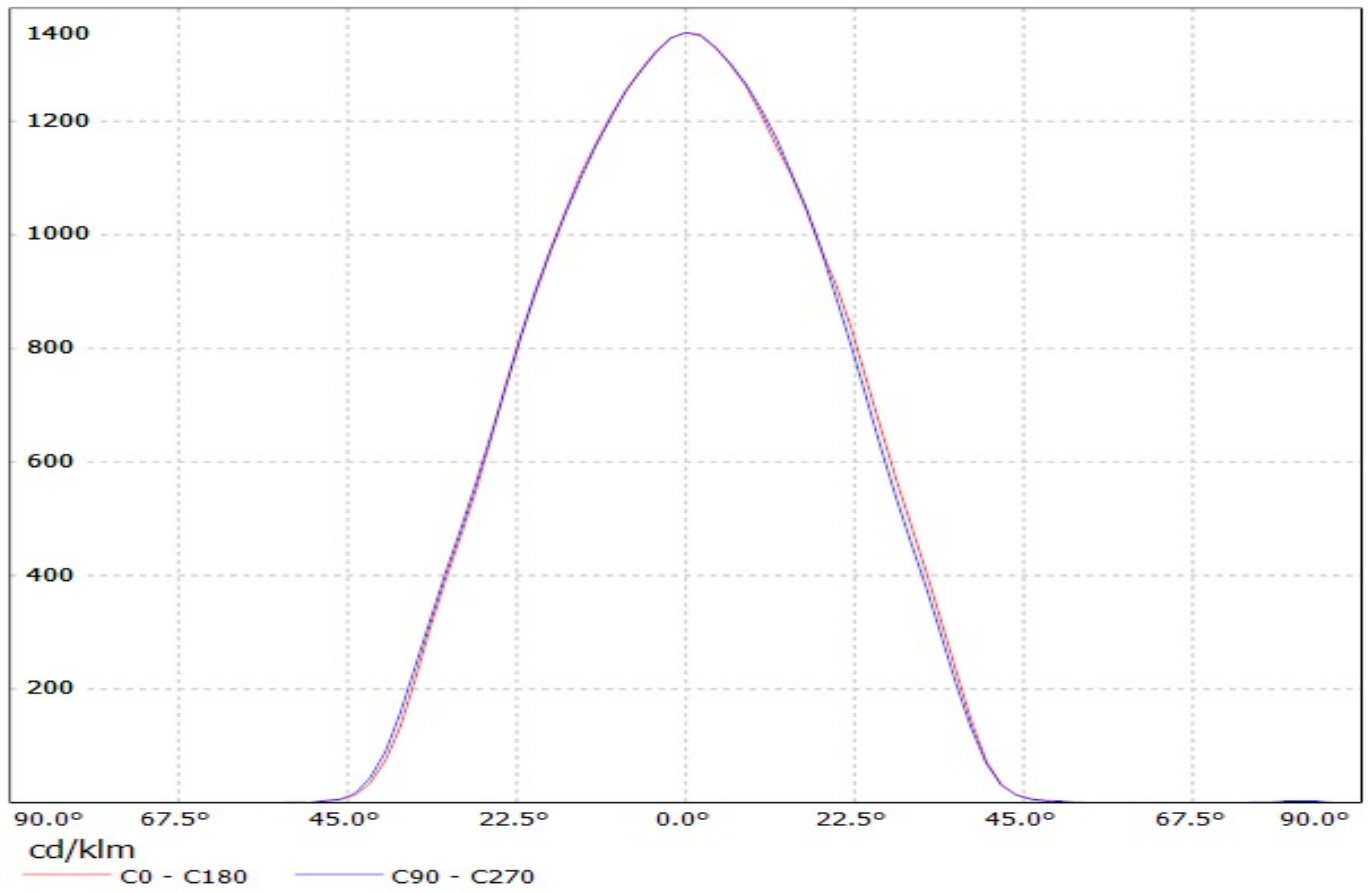

Luminaire: Ledil FCN13929\_BARBARA-WW-PF-VERO13/18\_(NFDxJ130B)  
Lamps: 1 x Nichia\_NFDxJ130B\_(463 Typ L2)\_C13709\_PF-SOCKET-VERO13-18\_1532.05lm@250mA\_P=8.27W\_I=0.25A

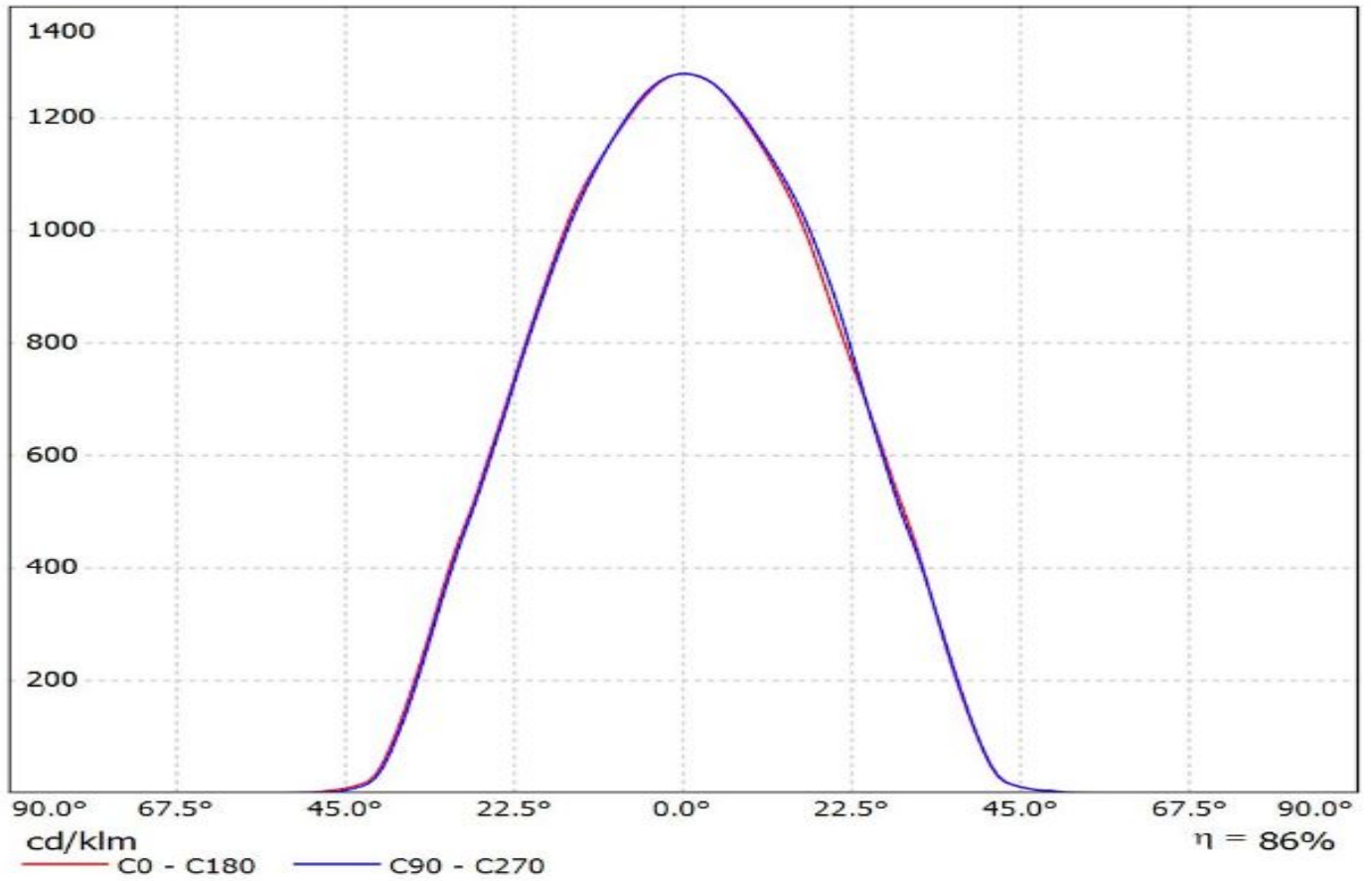

Luminaire: Ledil FCN13929\_BARBARA-WW-PF-VERO13/18\_(LC040B)\_(450\_Typ\_L2)\_(C13709)  
Lamps: 1 x Samsung\_LC040B\_(SPHWW1HDNE25010101)\_CCT=3000k\_(450\_Typ\_L2)\_(C13709\_PF-SOCKET-VERO13-18)\_1115.79lm@250mA\_P=8.075W\_I=0.25A

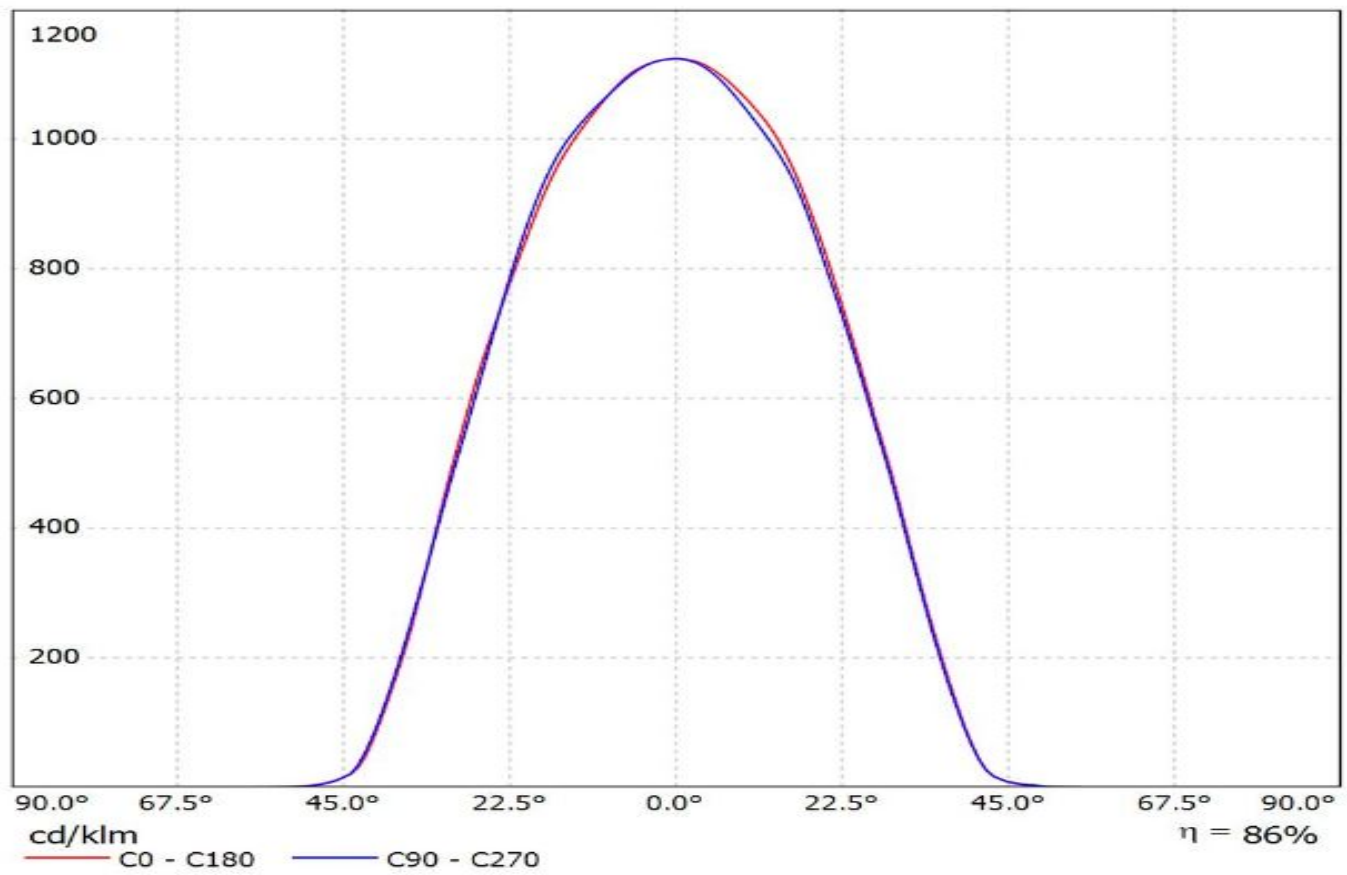

Luminaire: LEDil Oy FCN13929\_BARBARA-WW-PF-VERO1318\_(VERO18)

Lamps: 1 x Bridgelux VERO18 (BXRC-30E4000F) 865lm @ 250mA CCT=3200K P=6.9W I=250mA

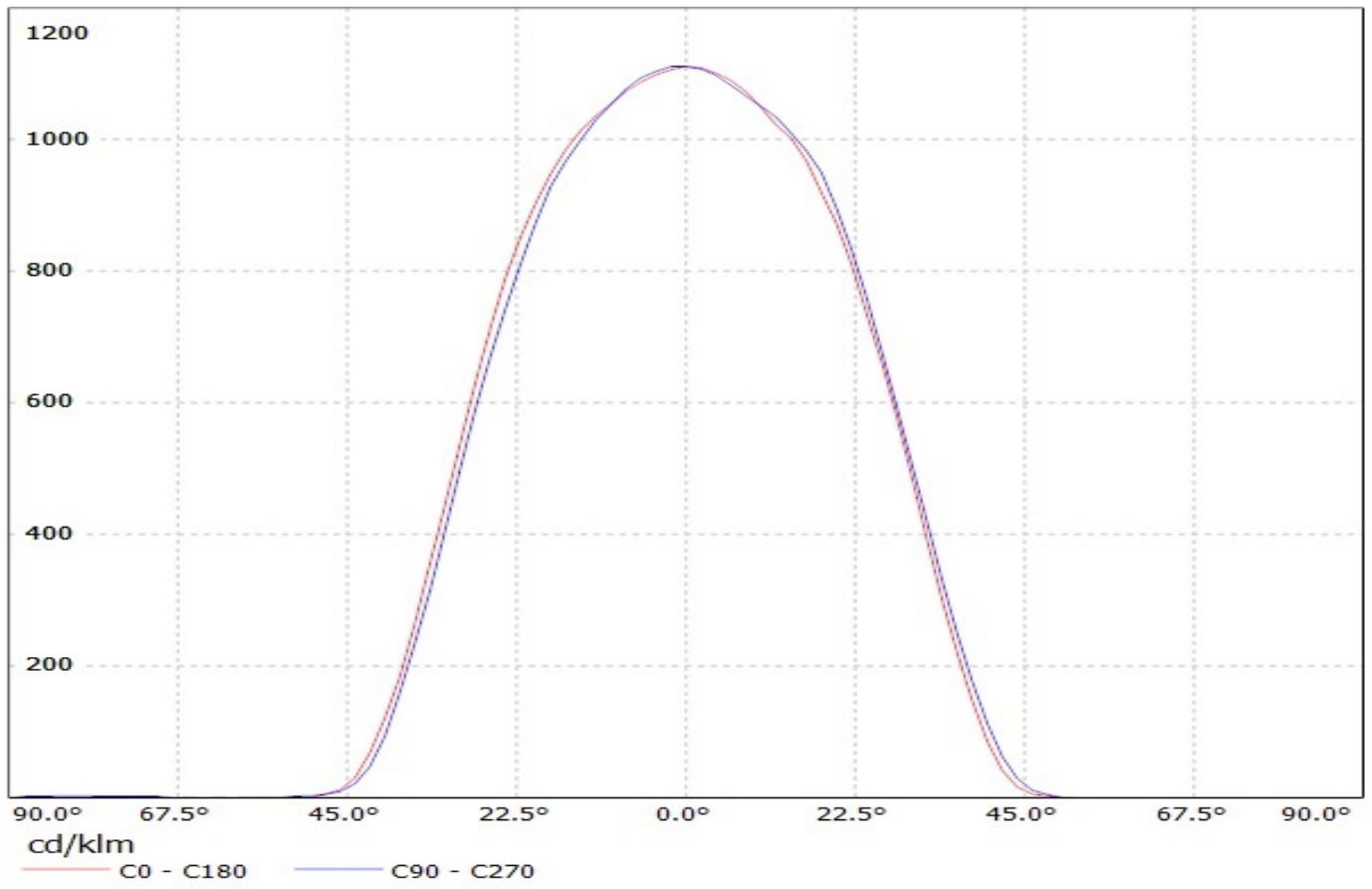

Luminaire: LEDiL Oy FCN13929\_BARBARA-WW-PF-VERO13-18\_(CLU700)

Lamps: 1 x Citizen\_CLU700\_(CLU700-1002B8-273M2G1)\_(C13709)\_(434\_Typ\_L1)\_374.62lm@100mA\_P=2.81352W\_I=0.1002A

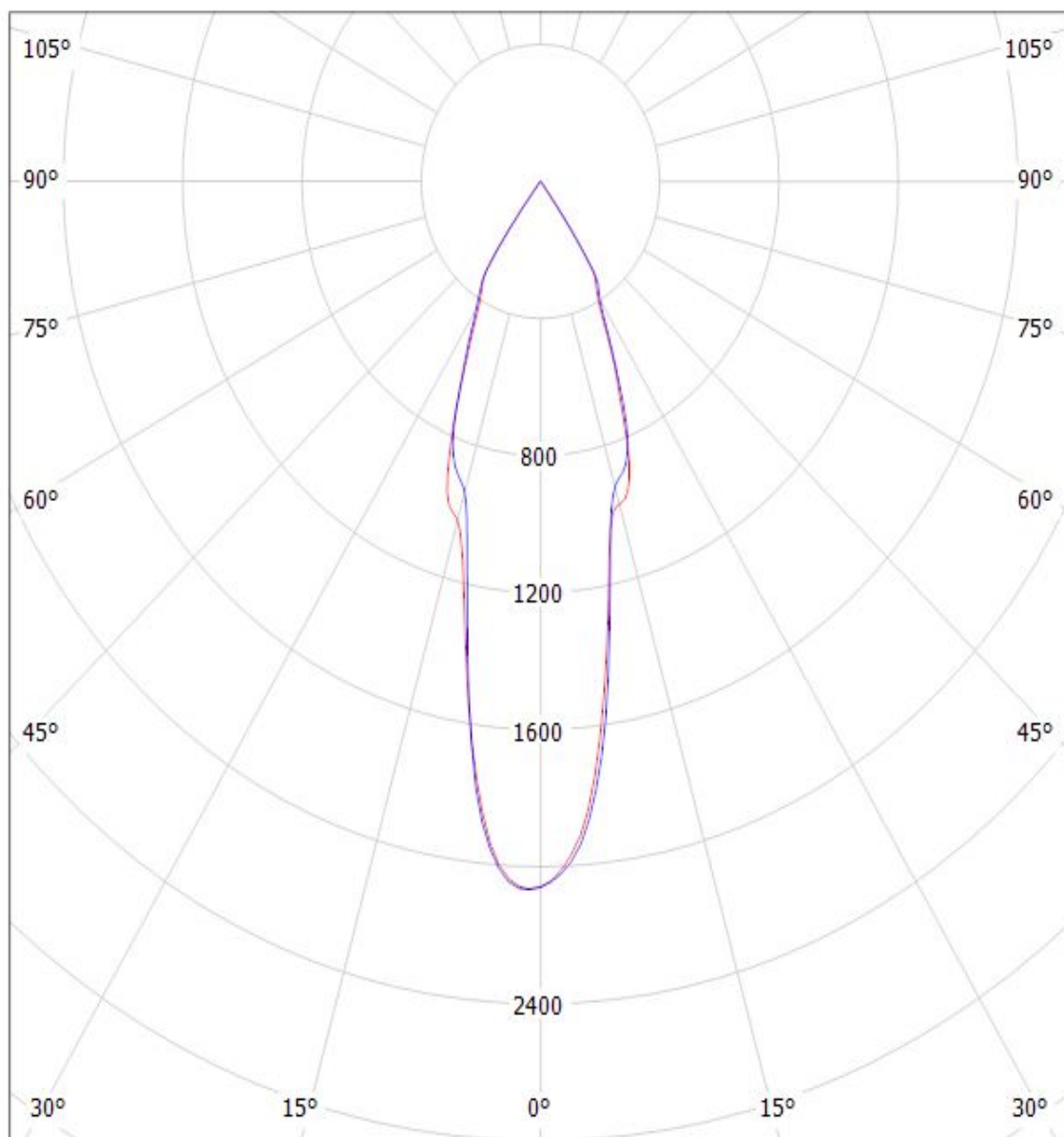

cd/klm

— C0 - C180 — C90 - C270

$\eta = 88\%$

Luminaire: LEDiL Oy FCN13929\_BARBARA-WW-PF-VERO13-18\_(Luxeon CoB 1203)

Lamps: 1 x Luxeon\_COB\_1203\_(LHC1-3080-1203)\_C13868\_LENA-STD-BASE-VERO13-18\_(438\_Typ\_L1)\_990.381lm@250mA\_P=8.6818W\_I=0.2498A

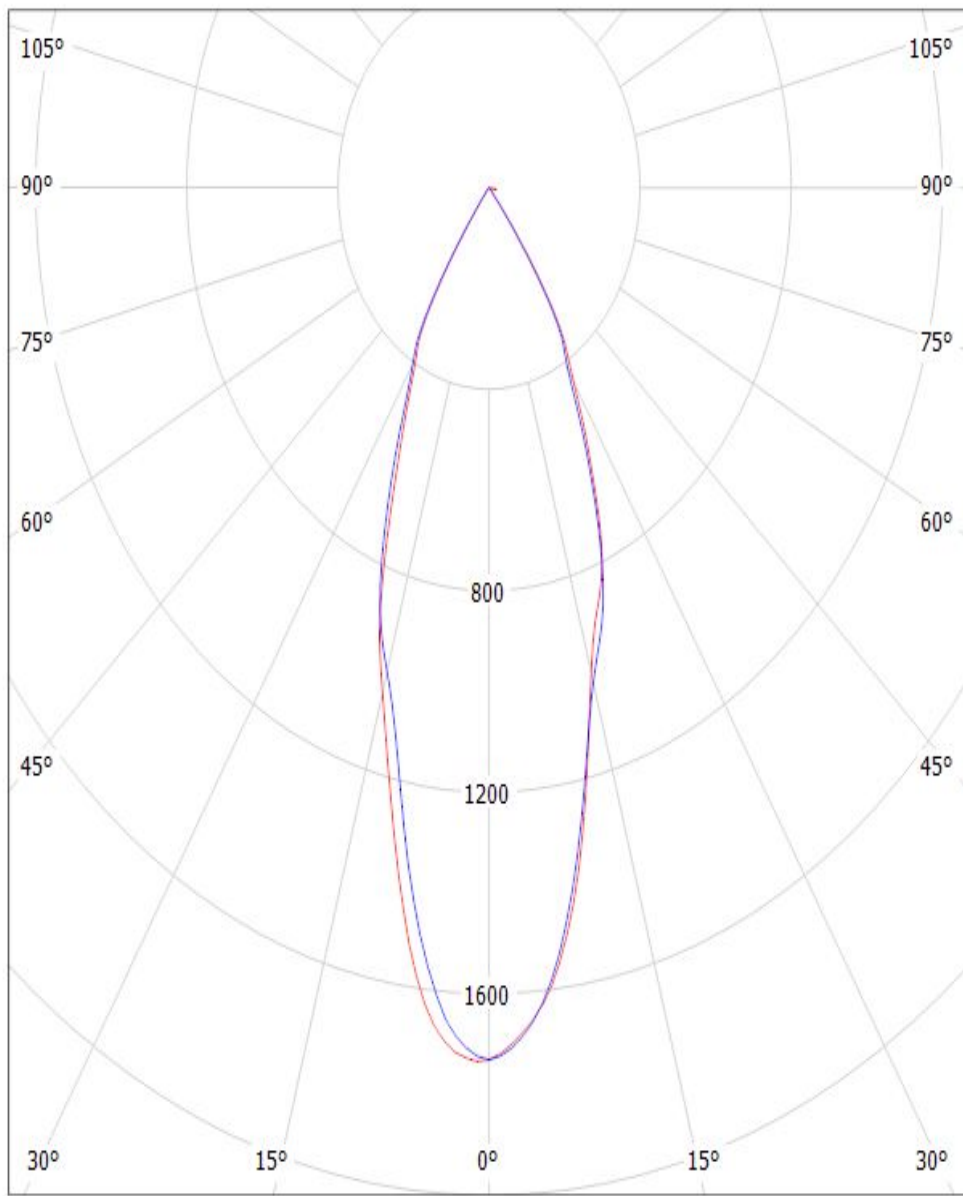

cd/klm

$\eta = 87\%$

— C0 - C180 — C90 - C270

Luminaire: LEDiL Oy FCN13929\_BARBARA-WW-PF-VERO13-18\_(NFCLL036B)

Lamps: 1 x Nichia NFCLL036B (sm403J1300R8000)\_542.652lm@100mA\_CCT=4000K\_P=3.34084W\_I=0.100A

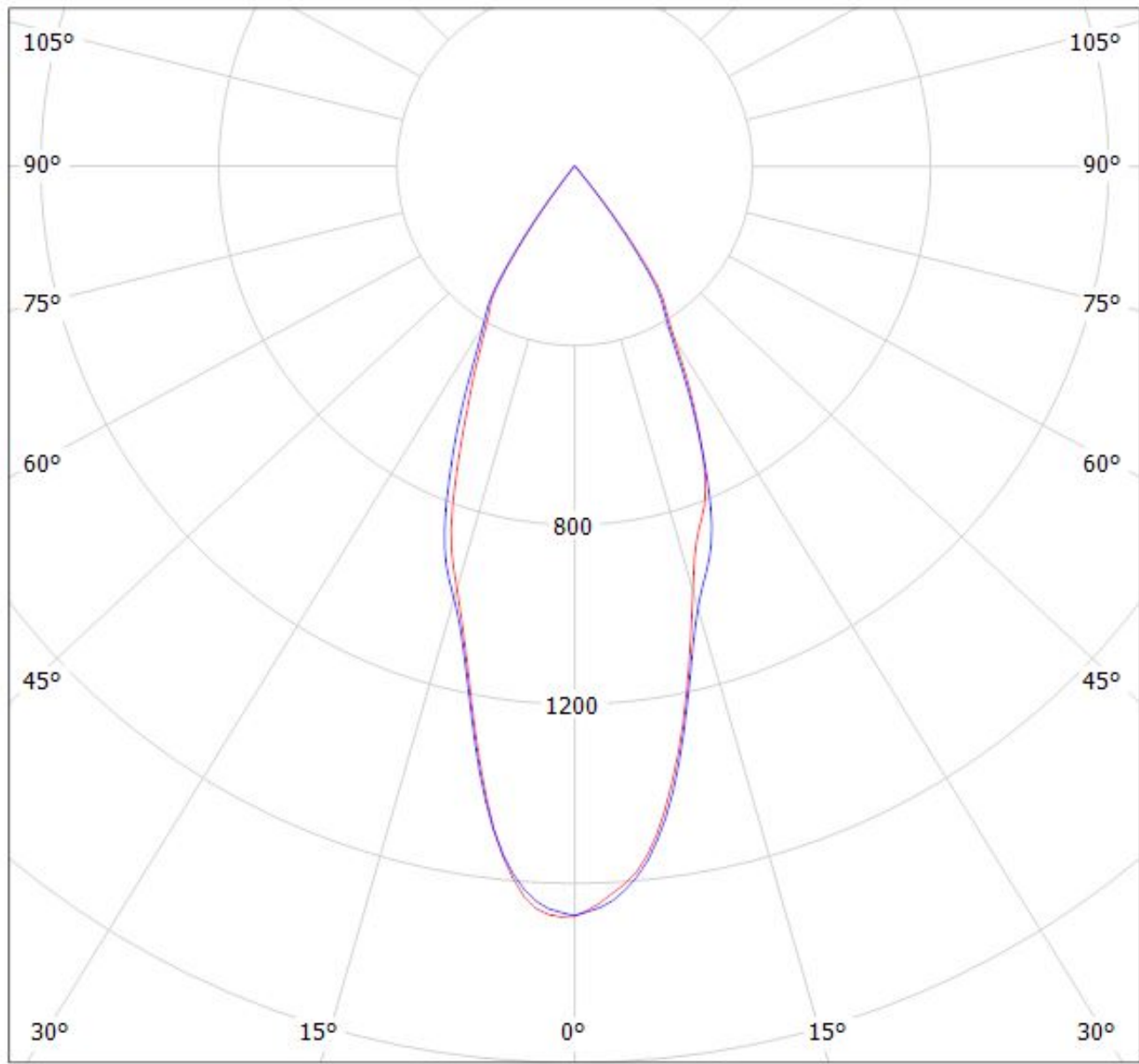

cd/klm

$\eta = 89\%$

— C0 - C180

— C90 - C270

Luminaire: Ledil FCN13929\_BARBARA-WW-PF-VERO13-18\_(CXA1520) CXA1520\_(CXA1520-30F-N4-N0H-00001)\_(441\_Typ\_L1)\_(C13709\_PF-SOCKET-VERO13-18)\_1036.14lm@250mA\_P=8.825W\_I=0.25A

Lamps: 1 x CXA1520\_(CXA1520-30F-N4-N0H-00001)\_(441\_Typ\_L1)\_(C13709\_PF-SOCKET-VERO13-18)\_1036.14lm@250mA\_P=8.825W\_I=0.25A

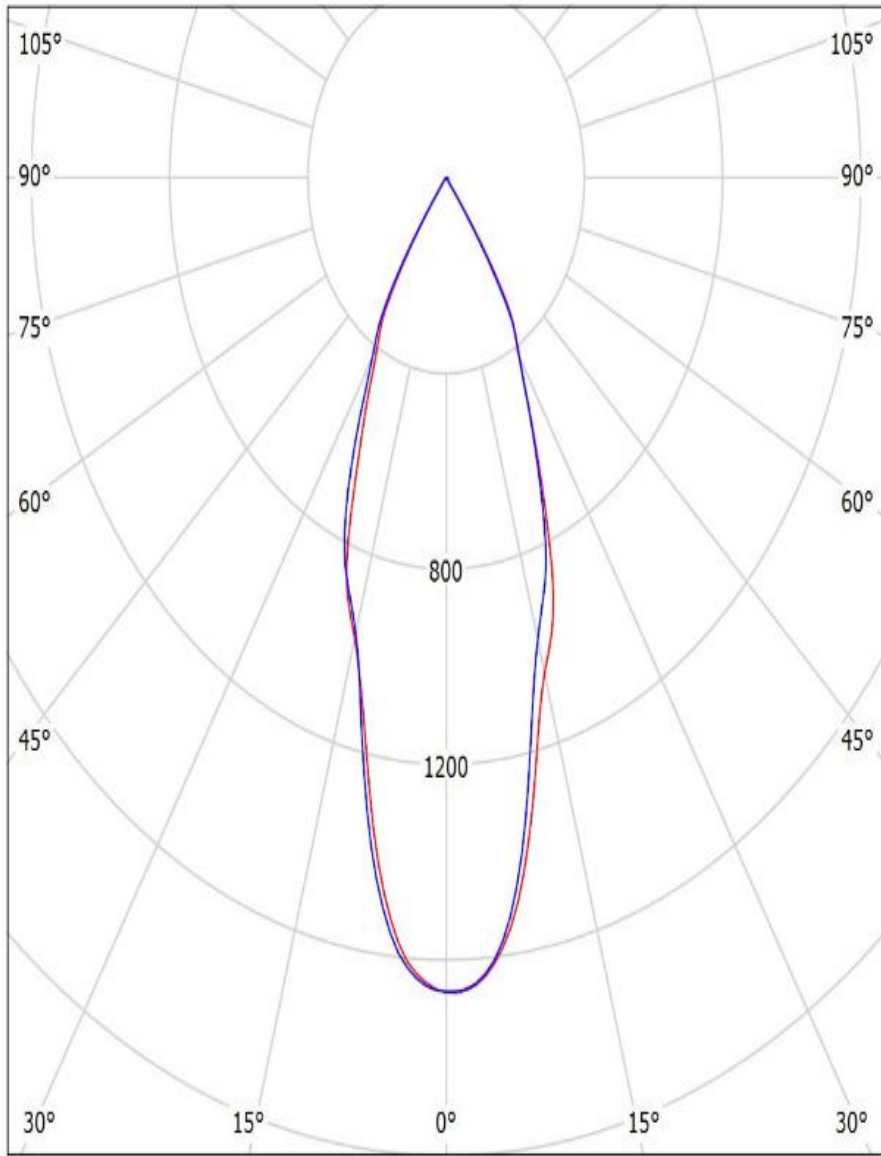

cd/klm

— C0 - C180 — C90 - C270

$\eta = 87\%$



Luminaire: LEDiL Oy FCN13929\_BARBARA-WW-PF-VERO13/18\_(Soleriq\_P9)\_Bender+Wirth\_connector\_461  
Lamps: 1 x Osram\_Soleriq\_P9\_(GQ\_MAFJB1.EM)\_875.631lm@250mA\_P=6.94894W\_I=0.2498A

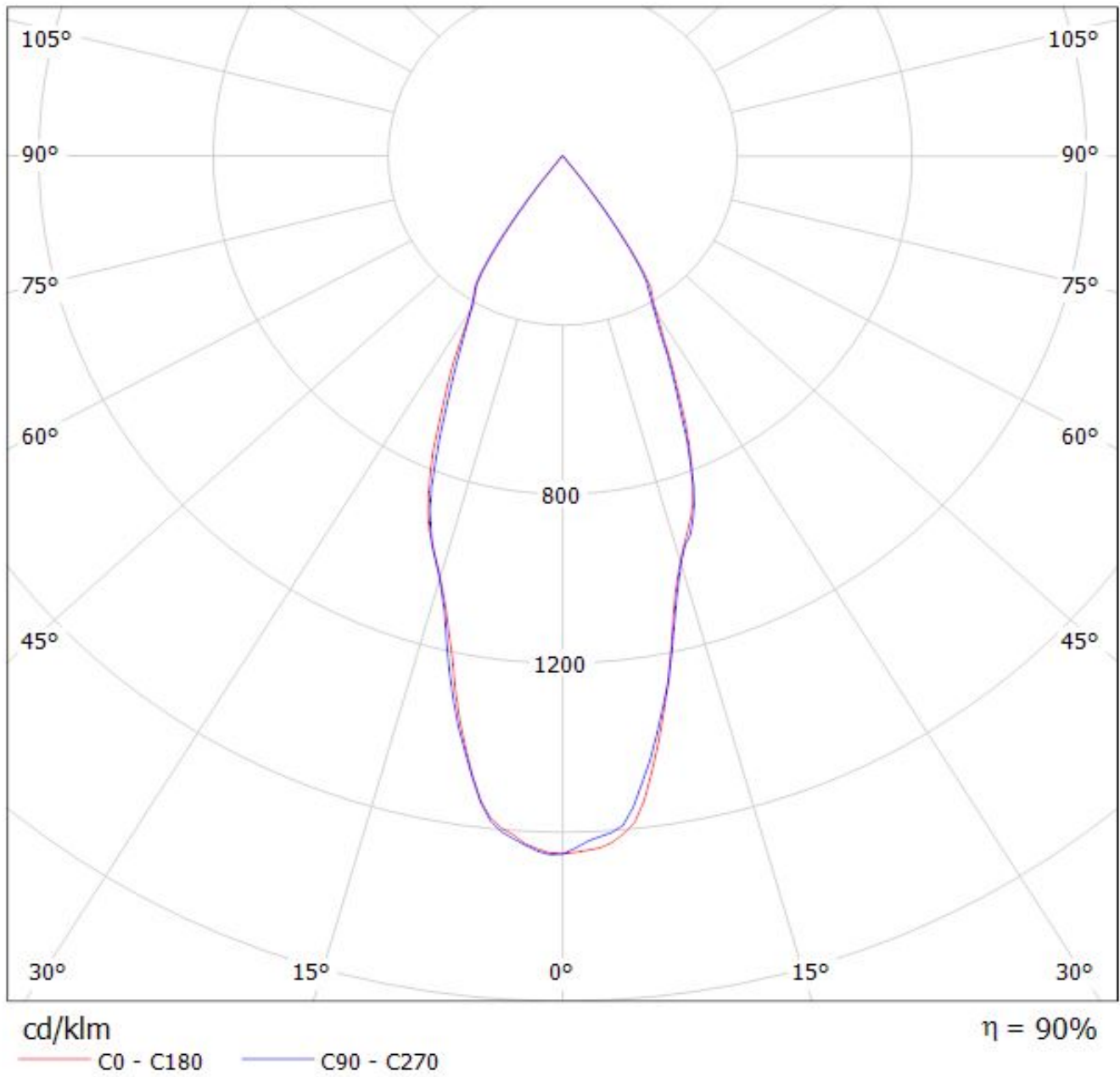

Luminaire: Ledil FCN13929\_BARBARA-WW-PF-VERO13/18\_(CLU024) Citizen\_CLU024\_(434\_Typ\_L1)\_  
(C13709\_PF-SOCKET-VERO13-18)\_1065.5lm@250mA\_P=8.55W\_I=0.25A  
Lamps: 1 x Citizen\_CLU024\_(434\_Typ\_L1)\_ (C13709\_PF-SOCKET-VERO13-18)  
\_1065.5lm@250mA\_P=8.55W\_I=0.25A

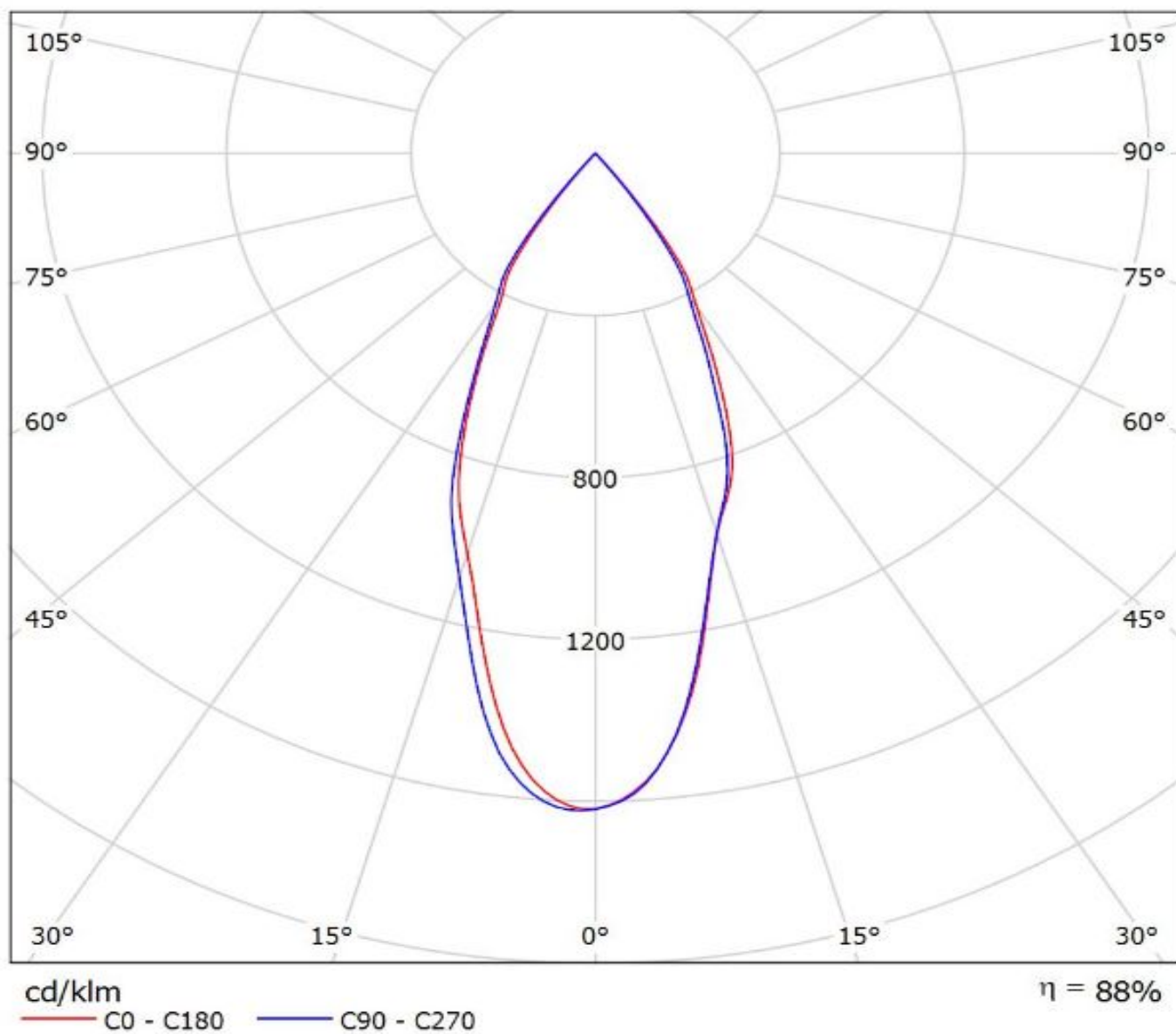

# Ledil FCN13929\_BARBARA-WW-PF-VERO13-18\_(CLU720)\_(433\_Typ\_L1) / LDC (Polar)

Luminaire: Ledil FCN13929\_BARBARA-WW-PF-VERO13-18\_(CLU720)\_(433\_Typ\_L1)  
Lamps: 1 x Citizen\_CLU720\_(433\_Typ\_L1)\_(C13709\_PF-SOCKET-VERO13-18)  
\_1233.06lm@250mA\_P=8.3W\_I=0.25A

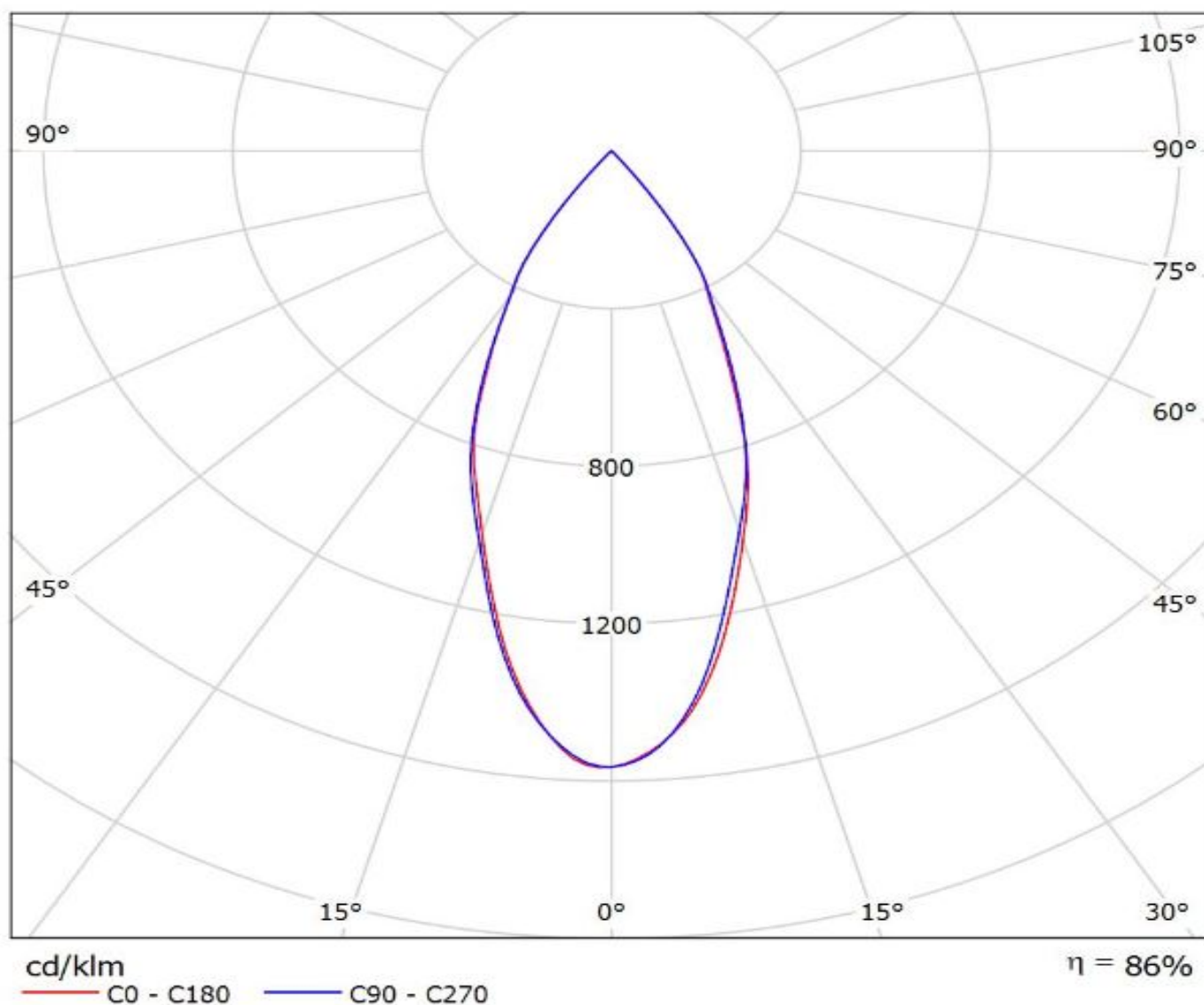

Luminaire: LEDiL Oy FCN13929\_BARBARA-WW-PF-VERO13/18\_(SLE-G5\_LES-11)

Lamps: 1 x Tridonic\_SLE-G5\_LES-11\_1142.55lm@250mA\_P=8.4070W\_I=0.250A

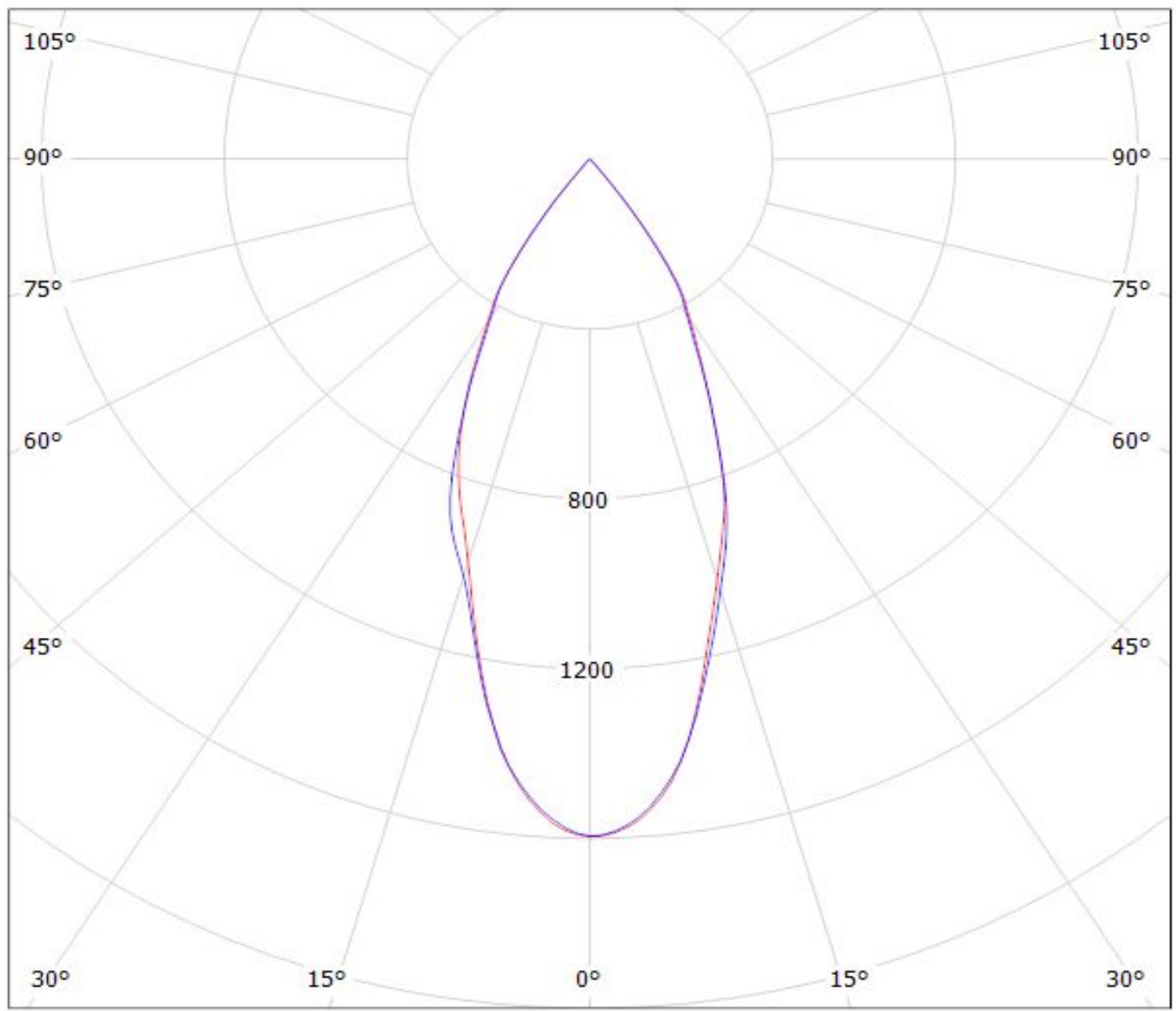

cd/klm

— C0 - C180 — C90 - C270

$\eta = 89\%$

# Ledil FCN13929\_BARBARA-WW-PF-VERO13-18\_(CXA1850) / LDC (Polar)

Luminaire: Ledil FCN13929\_BARBARA-WW-PF-VERO13-18\_(CXA1850)  
Lamps: 1 x CREE\_CXA1850\_(CXA1850-30F-T4-N0Y-00001)  
\_847.836lm@250mA\_CCT=3000K\_P=8.27W\_I=0.25A

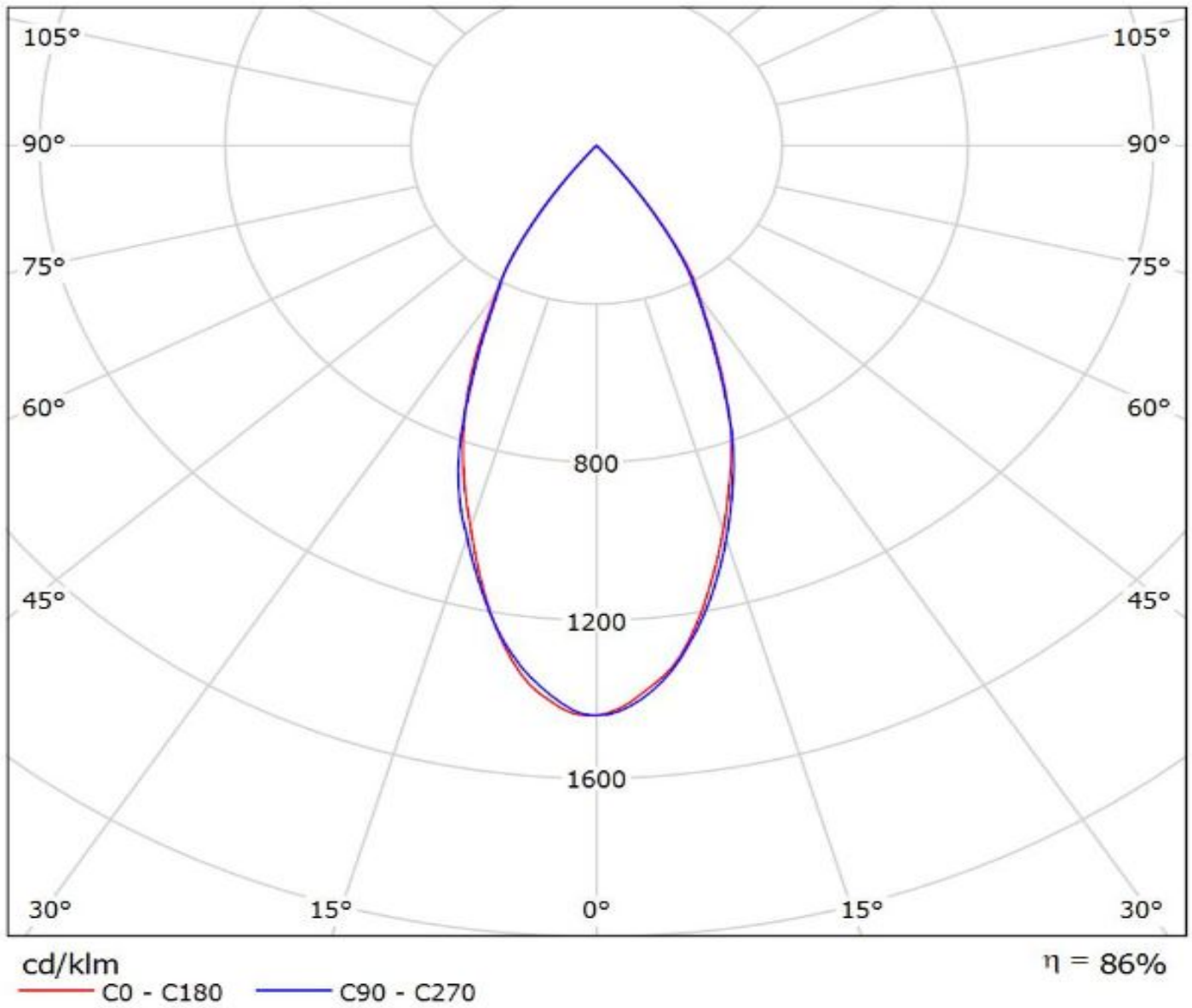

Luminaire: Ledil FCN13929\_BARBARA-WW-PF-VERO13/18\_(NFCLL060B)

Lamps: 1 x Nichia\_NFCLL060B\_(438\_TYP\_L1)\_1365.88lm@250mA\_P=8.375W\_I=0.25A

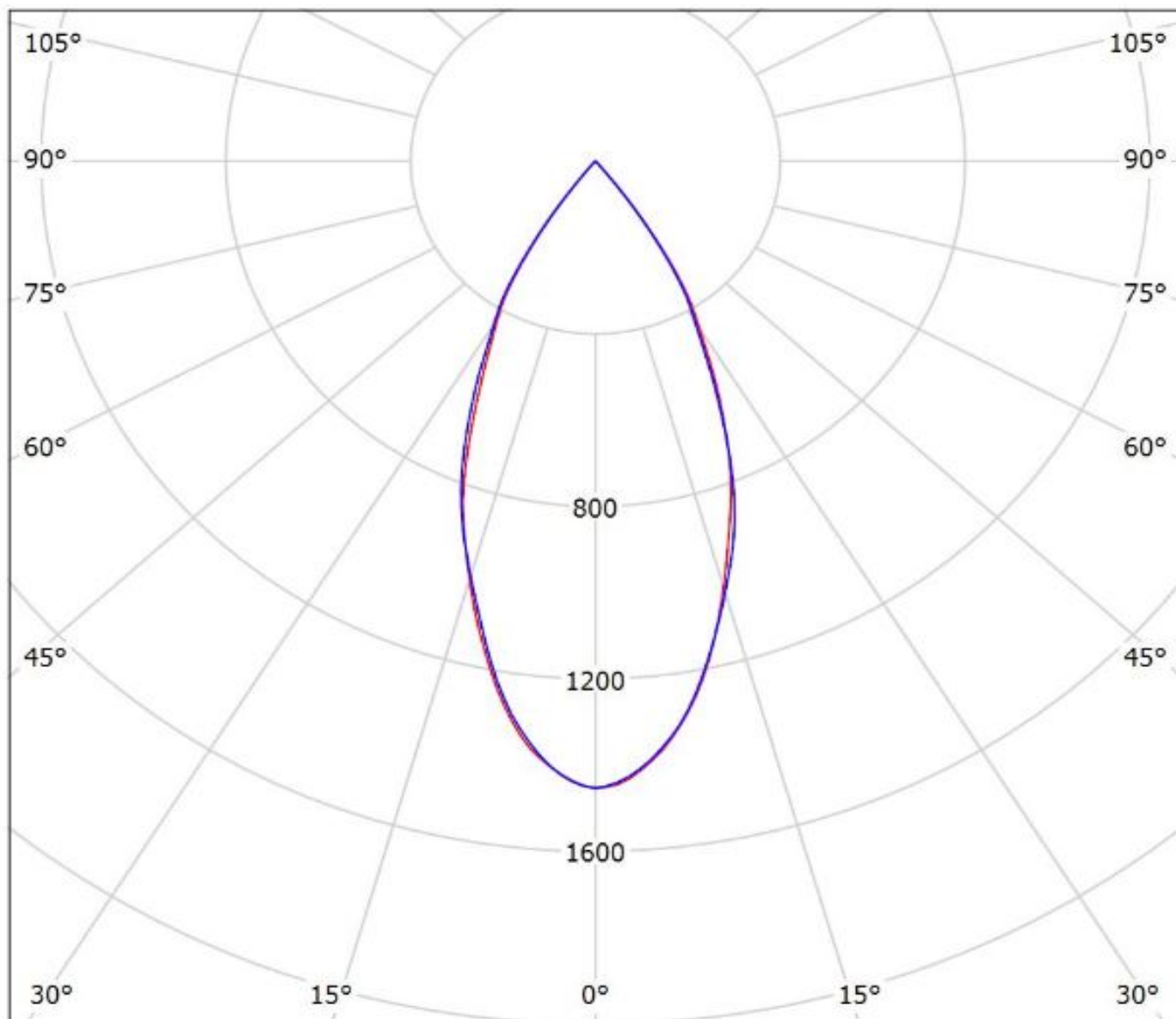

cd/klm

— C0 - C180 — C90 - C270

$\eta = 87\%$

Luminaire: Ledil FCN13929\_BARBARA-WW-PF-VERO13-18\_(Soleriq\_S13)

Lamps: 1 x Osram\_Soleriq\_S13\_(GW\_KAGHB1.EM)\_931.029lm@250mA\_P=7.44679W\_I=250mA

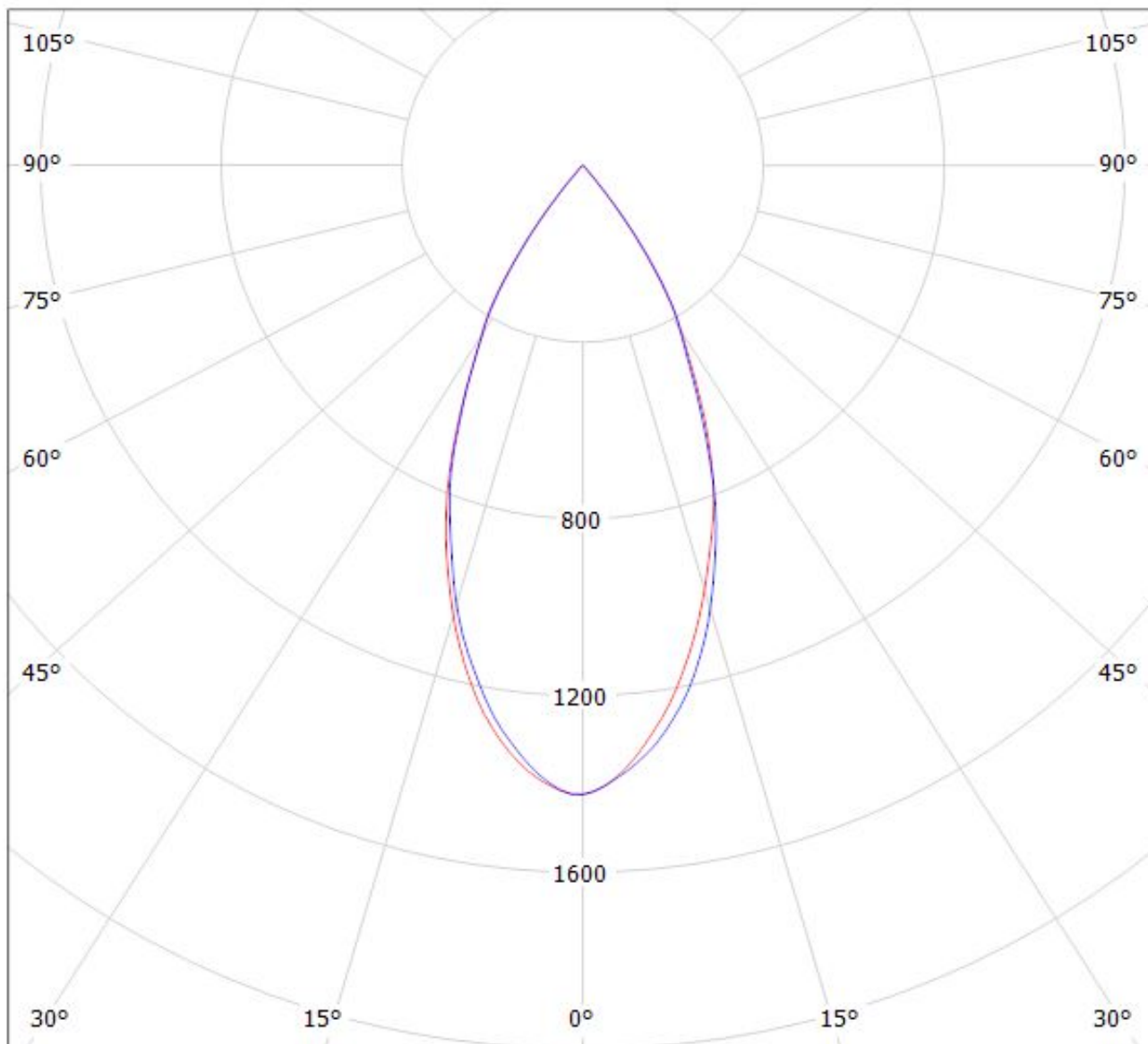

cd/klm

— C0 - C180

— C90 - C270

$\eta = 87\%$

Luminaire: LEDiL Oy FCN13929\_BARBARA-WW-PF-VERO13/18\_(Soleriq P13)  
Lamps: 1 x Osram Soleriq P13 (GW MAGMB1.EM)\_921.649lm@250mA\_CCT=3500K\_P=8.8097W\_I=0.25A

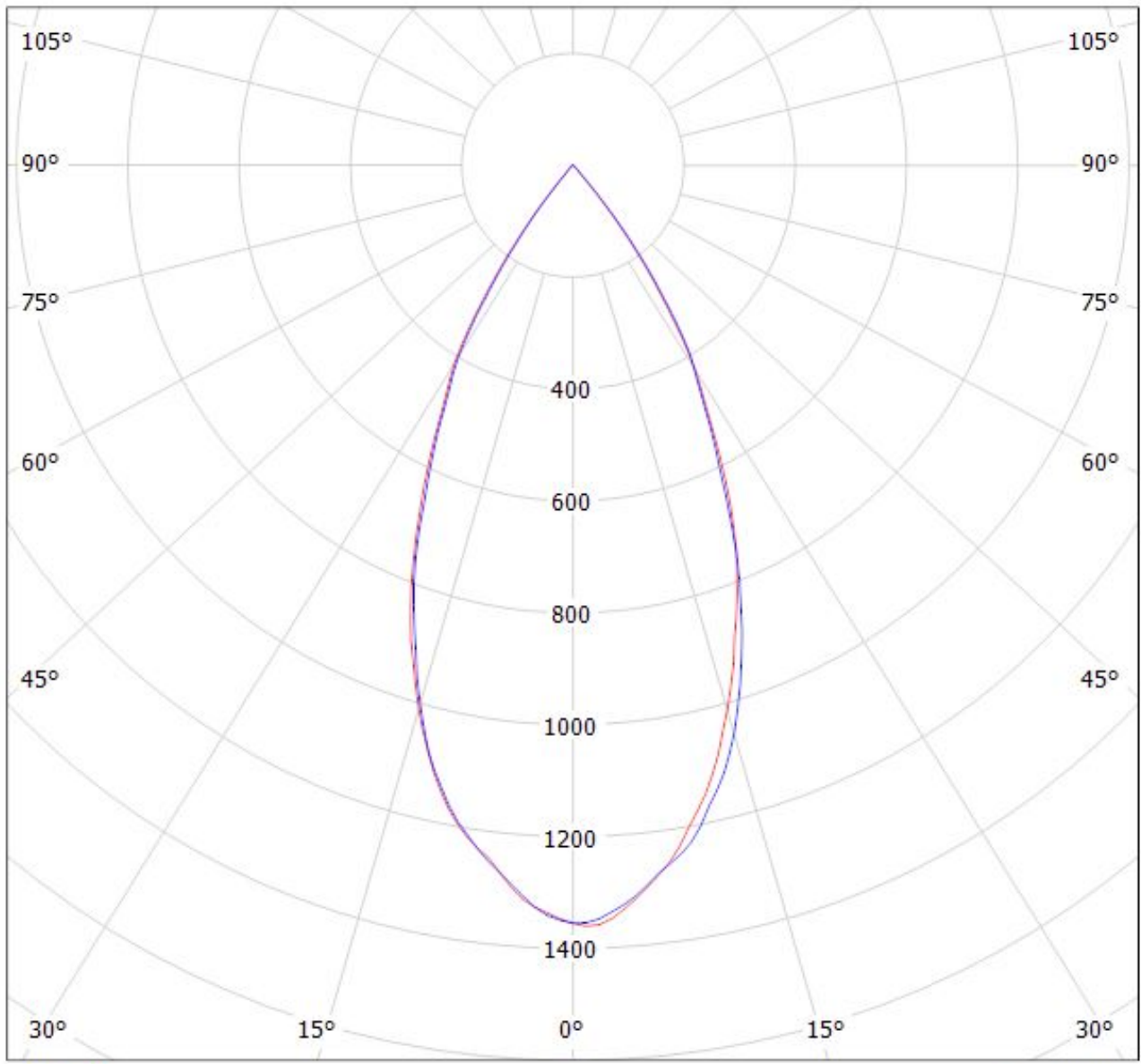

cd/klm

— C0 - C180    — C90 - C270

$\eta = 88\%$



# Ledil FCN13929\_BARBARA-WW-PF-VERO13-18\_(CLU034)\_(433\_Typ\_L1) / LDC (Polar)

Luminaire: Ledil FCN13929\_BARBARA-WW-PF-VERO13-18\_(CLU034)\_(433\_Typ\_L1)

Lamps: 1 x Citizen\_CLU034\_(CLU034-1205B8-303M1A2)\_1180.79lm@250mA\_P=8.50075W\_I=0.25A

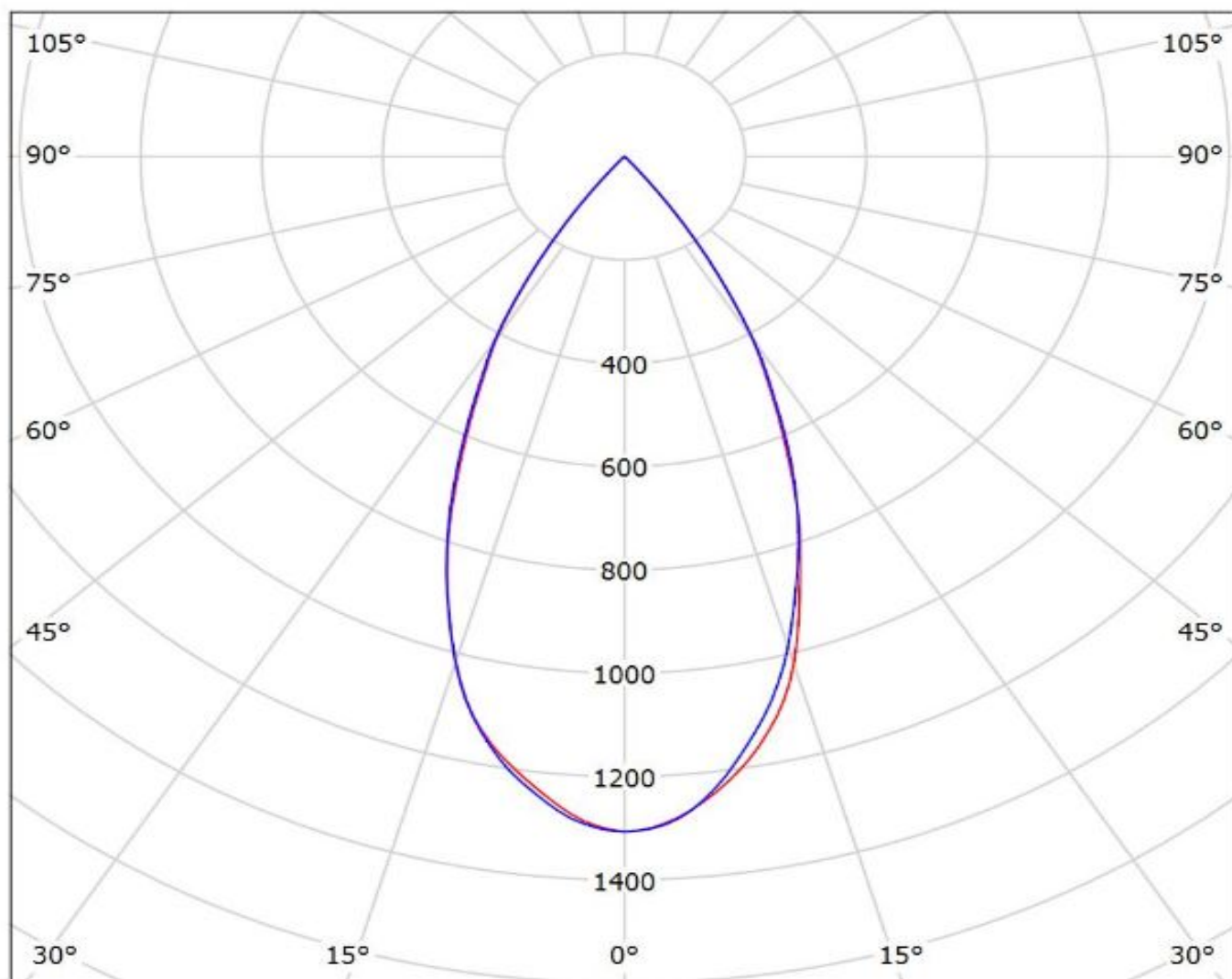

Luminaire: LEDil Oy FCN13929\_BARBARA-WW-PF-VERO1318\_(VERO13) Efficiency=90%  
Lamps: 1 x Bridgelux (BXRC-40E2000C) 1025lm @ 250mA CCT=4000K P=7.7W I=250mA

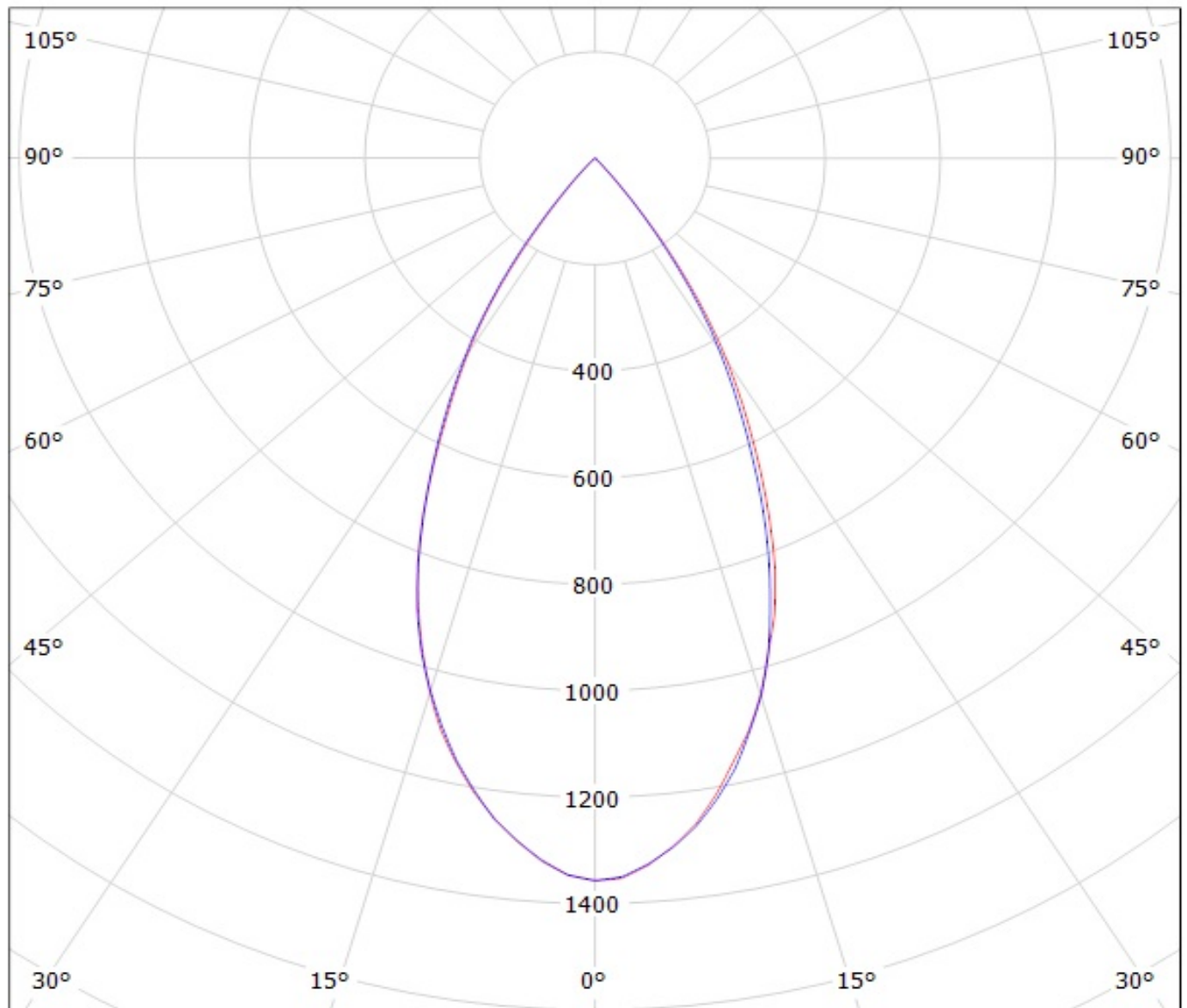

cd/klm

— C0 - C180

— C90 - C270

Luminaire: Ledil FCN13929\_BARBARA-WW-PF-VERO13/18\_(NFDxJ130B)  
Lamps: 1 x Nichia\_NFDxJ130B\_(463 Typ L2)\_C13709\_Pf-SOCKET-VERO13-18\_1532.05lm@250mA\_P=8.27W\_I=0.25A

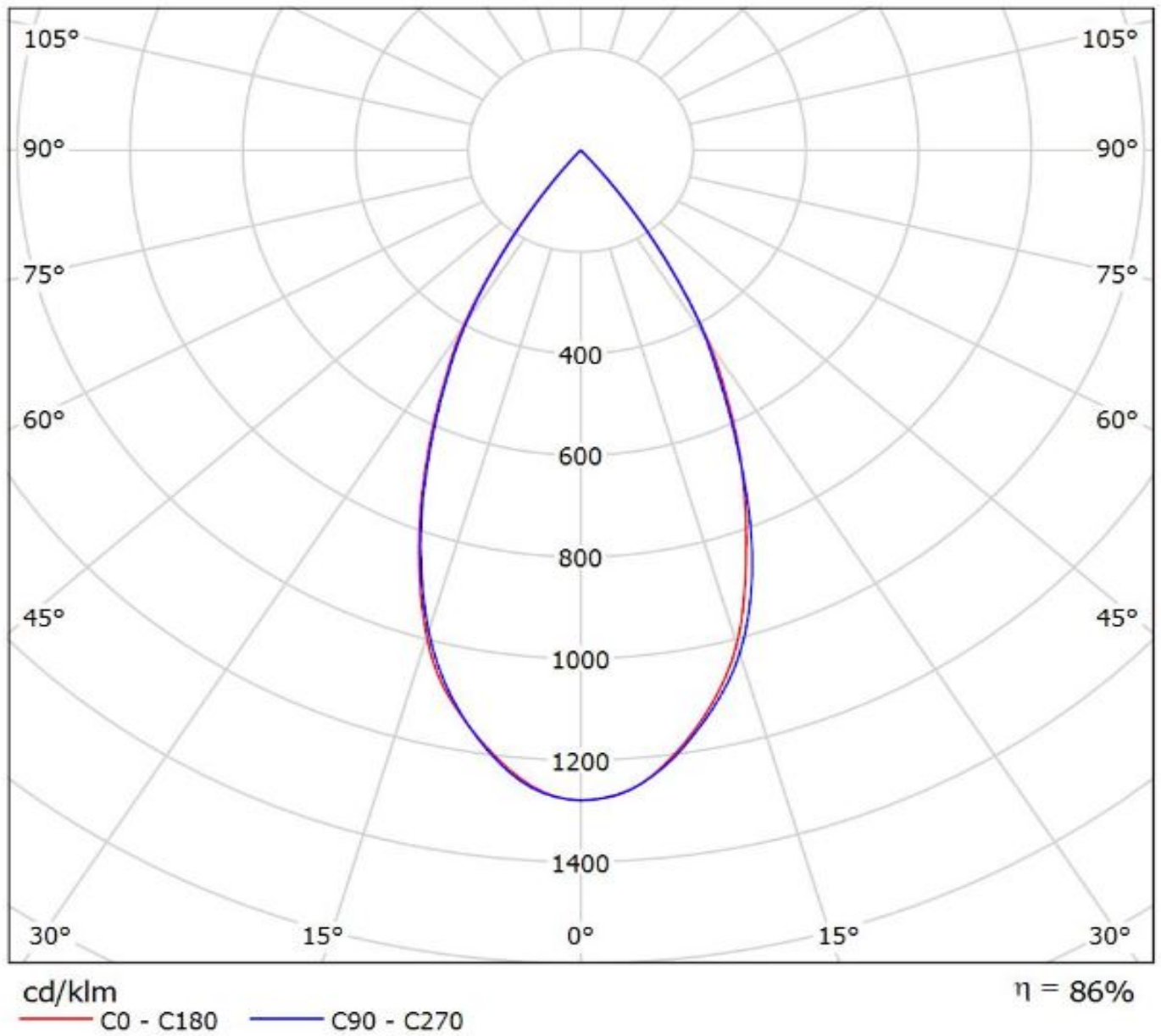

Luminaire: Ledil FCN13929\_BARBARA-WW-PF-VERO13/18\_(LC040B)\_(450\_Typ\_L2)\_(C13709)  
Lamps: 1 x Samsung\_LC040B\_(SPHWW1HDNE25010101)\_CCT=3000k\_(450\_Typ\_L2)\_(C13709\_PF-SOCKET-VERO13-18)\_1115.79lm@250mA\_P=8.075W\_I=0.25A

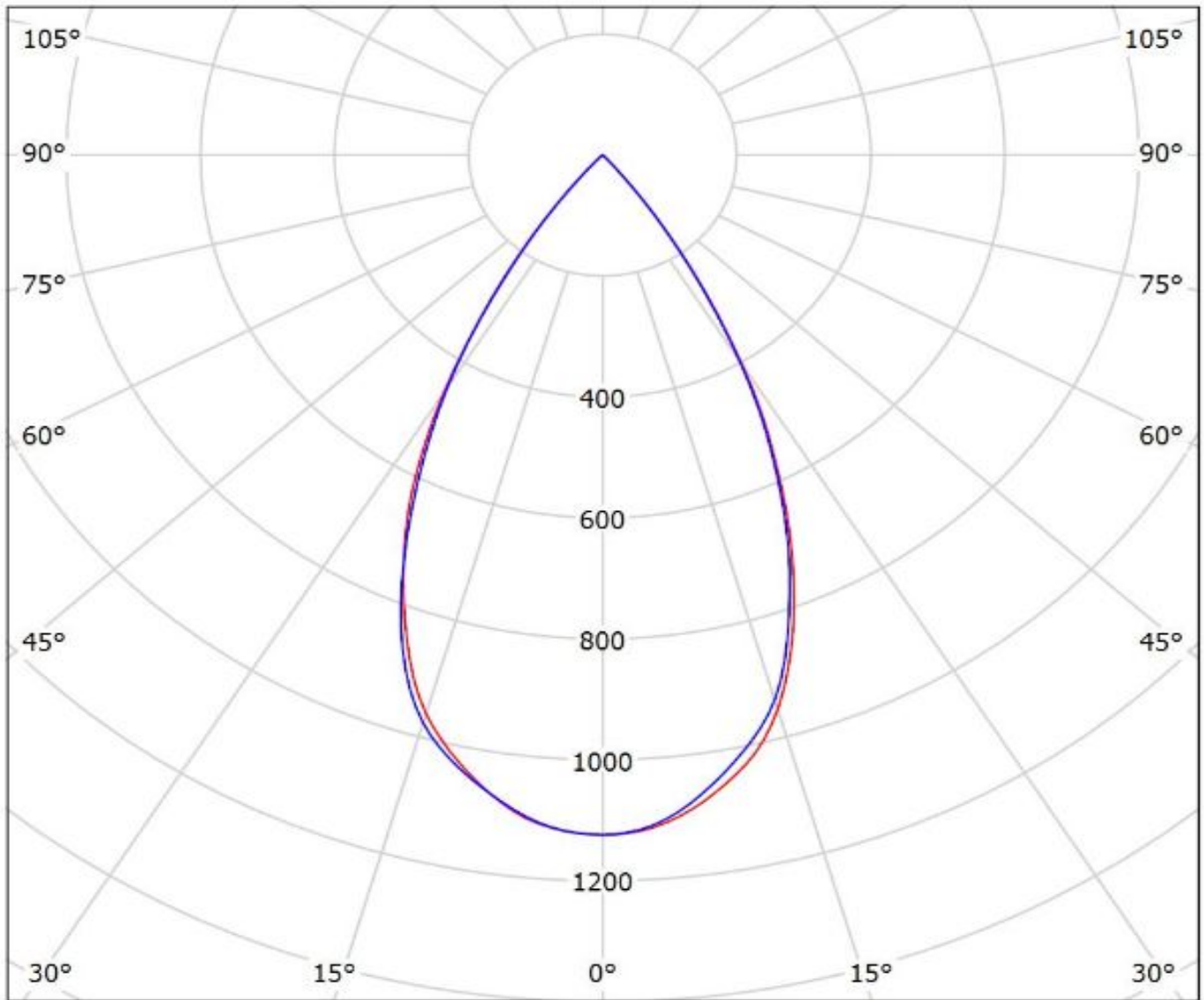

cd/klm

— C0 - C180    — C90 - C270

$\eta = 86\%$

Luminaire: LEDil Oy FCN13929\_BARBARA-WW-PF-VERO1318\_(VERO18)

Lamps: 1 x Bridgelux VERO18 (BXRC-30E4000F) 865lm @ 250mA CCT=3200K P=6.9W I=250mA

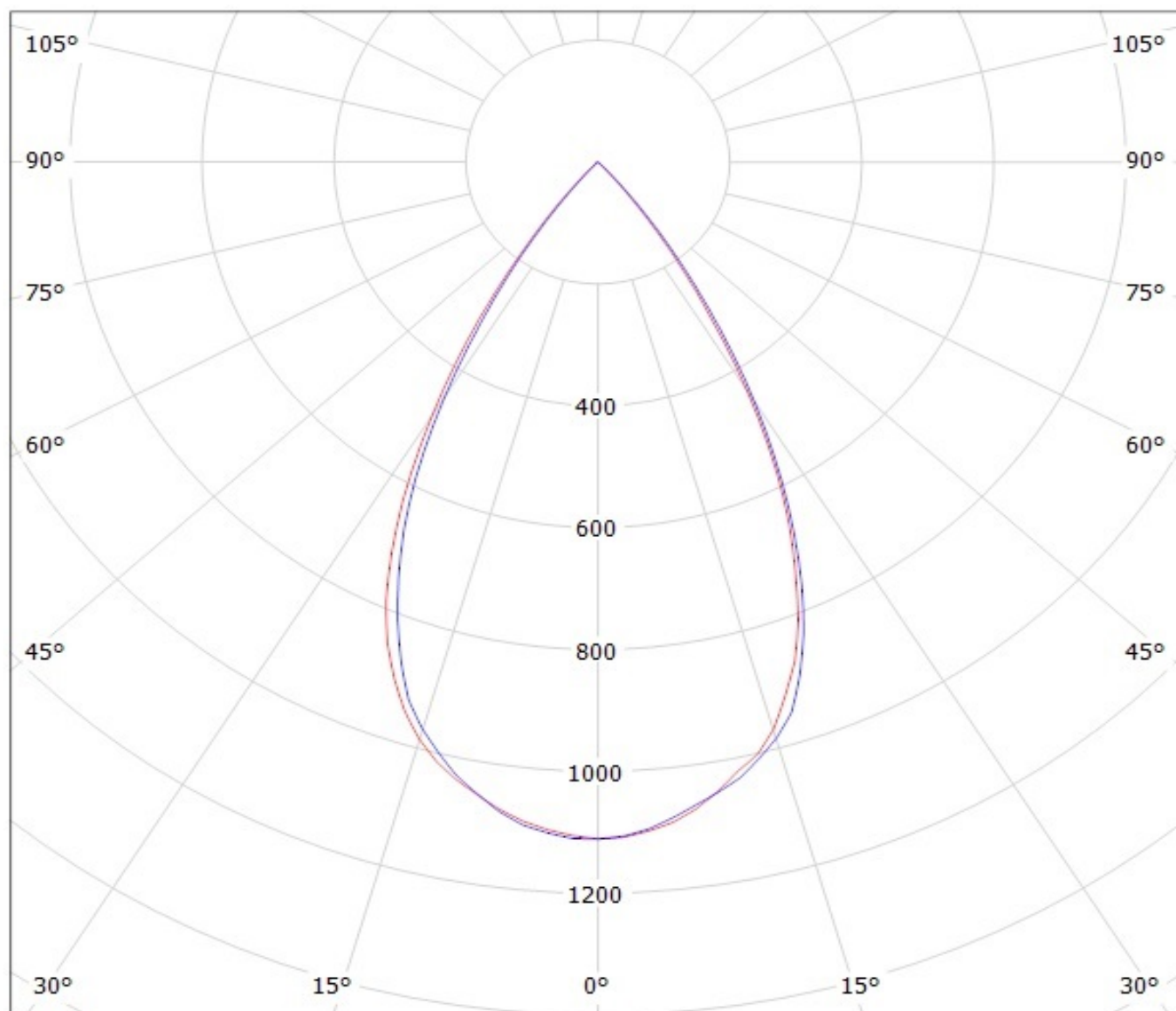

cd/klm

— C0 - C180

— C90 - C270

**NOTE: The typical divergence will be changed by different color, chip size and chip position tolerance. The typical total divergence is the full angle measured where the luminous intensity is half of the peak value.**

### **GENERAL INFORMATION**

- Product series especially designed & optimized for series of LEDs.
- Special care taken to make light distribution as uniform as possible.

Note! Due to use of high power COB's with this product, special attention to proper thermal design is highly recommended. LEDiL has no liability for direct, indirect or consecutive damages arising from the LEDiL products being used outside of the recommended temperature range.