

DETTAGLIO A

DETTAGLIO B

DETTAGLIO C

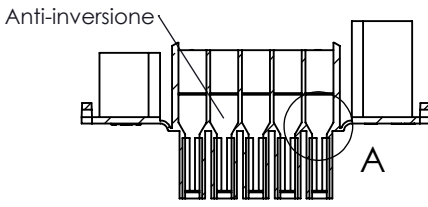
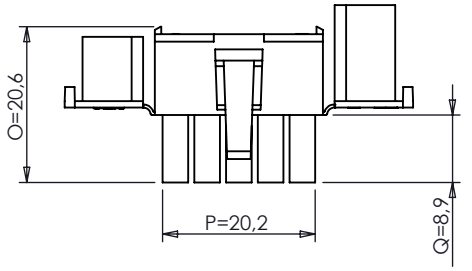
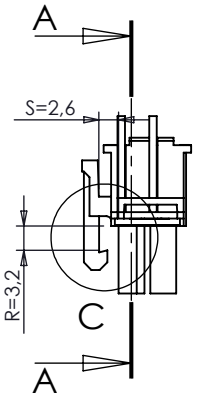

SEZIONE A-A  
SCALA 1:1

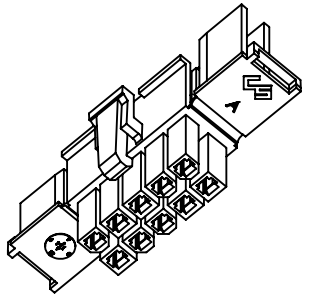
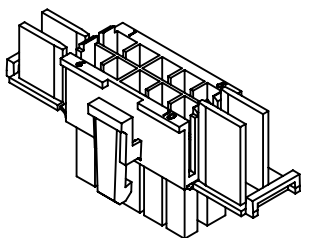
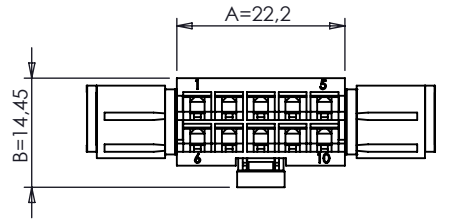

6	Miglioria anti inversione, datario e nuovo termoplastico	16-06-2014
5	Aumentati smussi cavità a 0,6 mm ( dettaglio A )	15-05-2014
4	Aggiornamento cartiglio e inserti smussi nelle cavità	06-03-2014
3	Aggiornamenti: logo, n. vie, n. cavità	15-11-2013
2	Inserita numerazione vie (dettaglio B)	30-01-2012
1	Aggiunte tolleranze generali (dettaglio B)	09-09-2011
INDEX	MODIFICATION	DATE



CS S.r.l.  
20063 CERNUSCO S/N - VIA COMO, 11  
TEL +39.02.9210.7404 - FAX +39.02.9210.0217  
<http://www.cscolombo.com> - e-mail: [info@cscolombo.com](mailto:info@cscolombo.com)

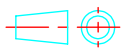

CHECKED BY	DATE	DESIGN UNITS
Stefano Galimberti	01-06-2011	METRIC
DRAWN BY	DATE	WEIGHT
Stefano Querzoli	01-06-2011	

DIMENSIONS WITHOUT TOLERANCES		CS-MFT52M	PA66 UL94 V-2
$\angle \pm 2^\circ$	0 - 6	±0.1	CS-MFT52MV0
	6 - 30	±0.2	PA6/66 UL94 V-0
	> 30	±0.3	CS-MFT52MV0750NF
			PA66 UL94 V-0 GWIT 775
			CS-MFT52MFV7-G
			PA6 UL94 V-2 GWIT 775
			CS-MFT52M-162.05
			PA66GF7-05 UL94-V2 GWIT 775°C
			PART NUMBER
			MATERIAL

SCALE	CAD REFER	SIZE	INDEX 0
1:1	Y:\dis\cs\mft\mftxm\Tavole\sw\tavole x escubedo\	A4	03-01-2011
BASE CODE		DESCRIPTION	
CS-MFT52M		Connettore maschio a 10 vie (5x2) p.4.2 mm	