

Features

- ◆ Ideal for automated placement
- ◆ Applicable for automative insertion
- ◆ High surge current capability
- ◆ Solder Dip 260°C, 10seconds

Mechanical Data

- ◆ Case:DFS
Epoxy meets UL-94V-0 Flammability rating
- ◆ Terminals:Matte tin plated leads, solderable per J-STD-002B and JESD22-B102D
- ◆ Polarity:As markde on body

Typical Applications

General purpose use in ac-to-dc bridge full wave rectification for SMPS, Lighting Ballaster, Adapter, Battery Chargwe, Home Appliances, Office Equipment, and Telecommunication applicationsy.

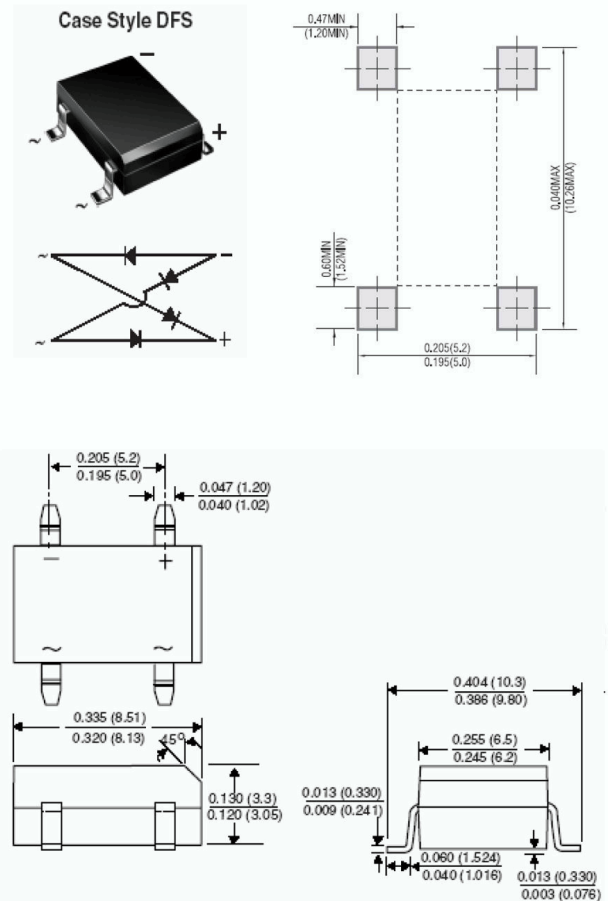

Maximum Ratings & Electrical Characteristics Ratings at 25°C

ambient temperature unless otherwise specified.

Parameter	Symbol	DF20005S	DF2001S	DF2002S	DF2004S	DF2006S	DF2008S	DF2010S	Unit
Maximum repetitive peak reverse voltage	V_{RRM}	50	100	200	400	600	800	1000	V
Maximum RMS voltage	V_{RMS}	35	70	140	280	420	560	700	V
Maximum DC blocking voltage	V_{DC}	50	100	200	400	600	800	1000	V
Maximum Average forward output rectified current at TA=40°C	$I_{F(AV)}$	2.0							A
Peak forward surge current single sine-wave superimposed on rated load (JEDEC Method)	I_{FSM}	60							A
Rating for fusig (t<8.3ms)	i^2t	10							A ² sec
Maximum instantaneous forward voltage drop per leg at 2A	VF	1.20							V
Maximum DC reverse current at TA=25°C rated DC blocking voltage per leg TA=125°C	IR	5 500							μA
Typical junction capacitance per eiement at 4.0V,1MHz	Cj	25							pF
Operating junction temperature range	TJ	-55 to +150							°C
Storage temperature range	T _{STG}	-55 to +150							°C

Notes:

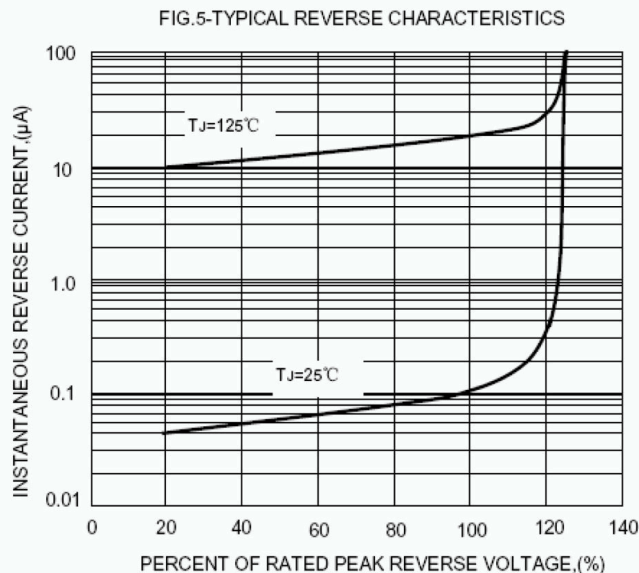
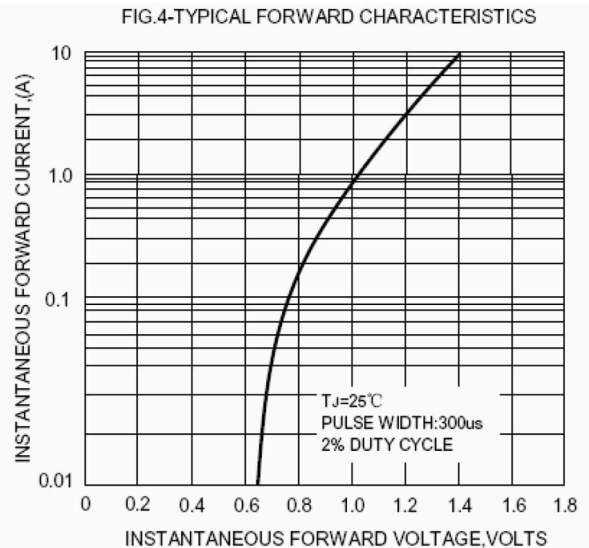
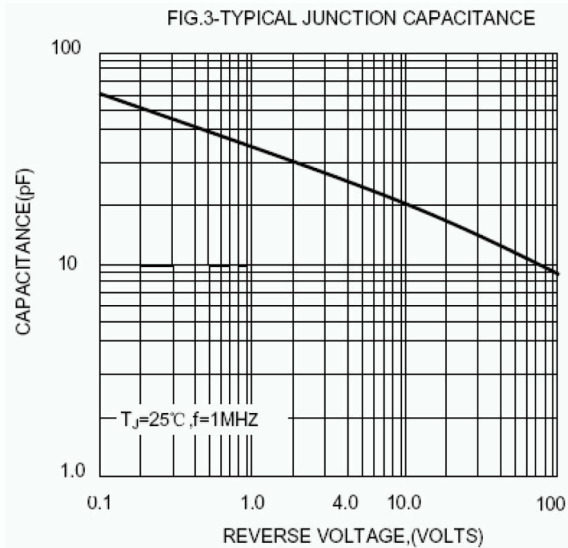
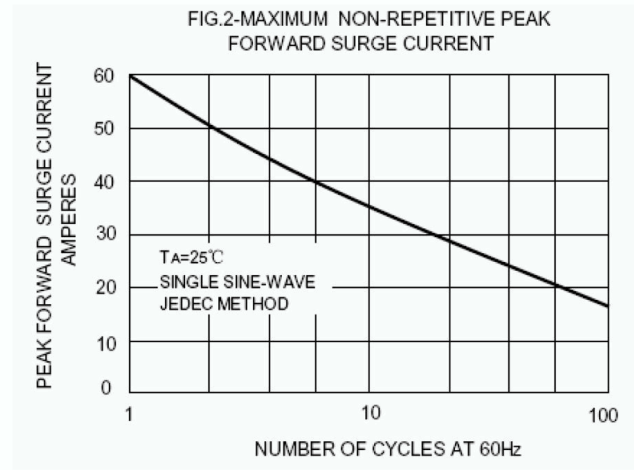
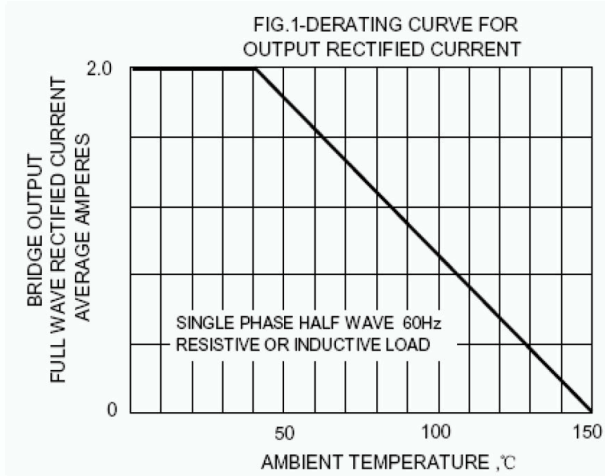
Ratings and Characteristics Curves ($T_A = 25^\circ\text{C}$ unless otherwise noted)





DF20005S thru DF2010S

Miniature Glass Passivated Single-Phase Bridge Rectifier
Reverse Voltage 50 and 1000V Forward Current 2.0A

Marking

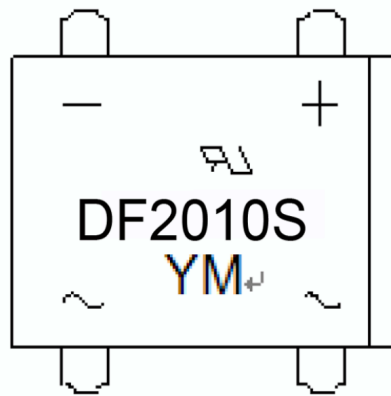

DATE CODE

Year	2009	2010	2011	2012	2013	2014	2015	2016	2017	2018	2019	2020
Code	9	A	B	C	D	E	F	G	H	J	K	0
Month	1	2	3	4	5	6	7	8	9	10	11	12
Code	1	2	3	4	5	6	7	8	9	O	N	D