

Figure 1.1. Top View of AHV12V8KV2R5MAW

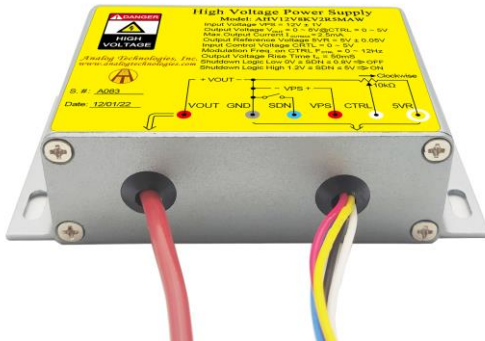

Figure 1.2. Side View

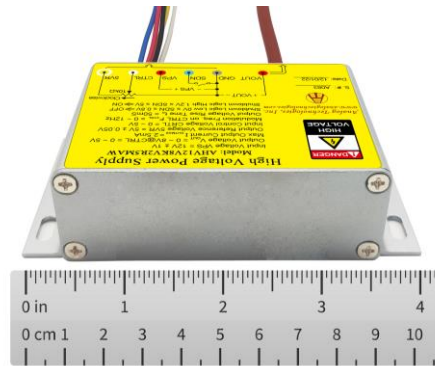

Figure 1.3. Side View



Figure 1.4. Side View

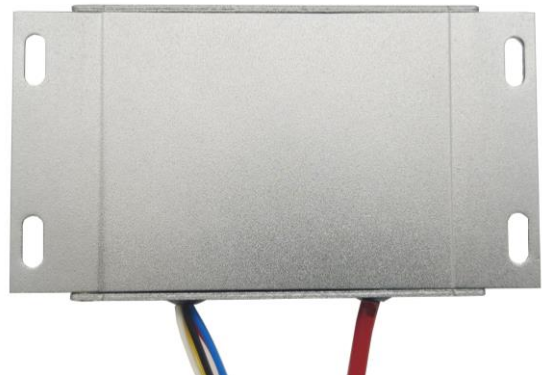

Figure 1.5. Bottom View



FEATURES

- Input Power Voltage: 12V ± 1V
- Input Current Range: 575mA to 2.4A
- Output Voltage: 0 to 8000V@CTRL = 0 to 5V
- Max. Output Current: 2.5mA
- Reference Voltage: 5V ± 0.02V
- Input Control Voltage: 0 to 5V
- Electronic Shutdown Control Available
- Zero EMIs and Good Heat Sinking by Metal Enclosure

APPLICATIONS

This power module, AHV12V8KV2R5MAW, is designed for achieving DC-DC conversion from low voltage to high voltage as a power supply source. It can be used for:

- X-ray Machine
- Spectral Analysis
- Nondestructive Inspection
- Semiconductor Manufacturing Equipment
- Particle Accelerator
- Capillary Electrophoresis
- Particles Injection
- Physical Vapor Phase Deposition
- Electrospinning Preparation of Nanofiber
- Glass/ Fabric Coating
- DC Reactive Magnetron Sputtering

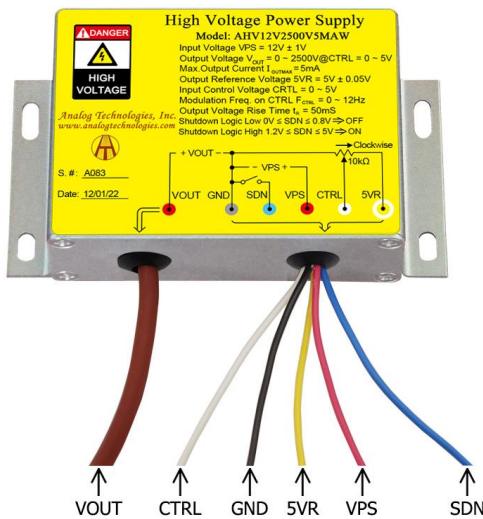

Figure 2. The Connecting Lead Wires of AHV12V8KV2R5MAW

Table 1. Pin Names, Colors, Functions and Specifications.

No.	Name	Description	Type	Color		Min.	Typ.	Max.
1	SDN	Shutdown logic low	Digital input	●	Blue	0V		0.8V
		Shutdown logic high				1.2V		5V
2	5VR	Reference voltage	Analog output	●	Yellow		5V	
3	CTRL	Regulation	Analog input	○	White	0V		5V
4	VPS	Input voltage	Power supply input	●	Red	11V	12V	13V
5	GND	Ground	Ground for power supply and analog & digital signals	●	Black		0V	
6	VOUT	Output high voltage	Power output	●	Brown	0V		2.5kV



DESCRIPTION

Figure 1 shows the actual pictures of AHV12V8KV2R5MAW. Figure 2 shows its connecting wires. More detail information is given in Table 1. The high voltage output can be set to a constant value between 0V to 8kV by connecting the CTRL port to the central tap of a POT (Potentiometer) or modulated by an AC signal ranging from 0V to 5V, as see Figure 3 and Figure 4 respectively. The output voltage equals to 1600 times the input control voltage: $V_{OUT}=1600 \times V_{CTRL}$.

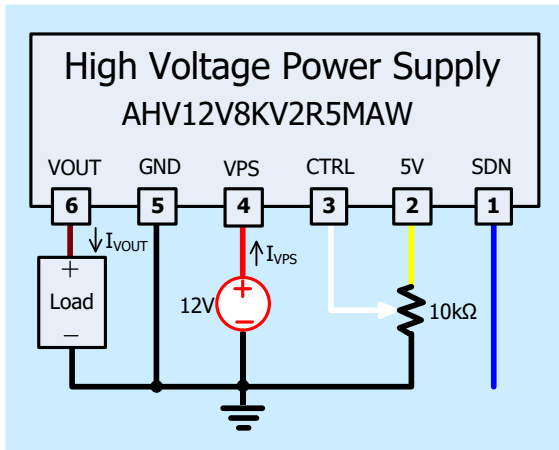

Figure 3. Setting Output to be a Constant Voltage

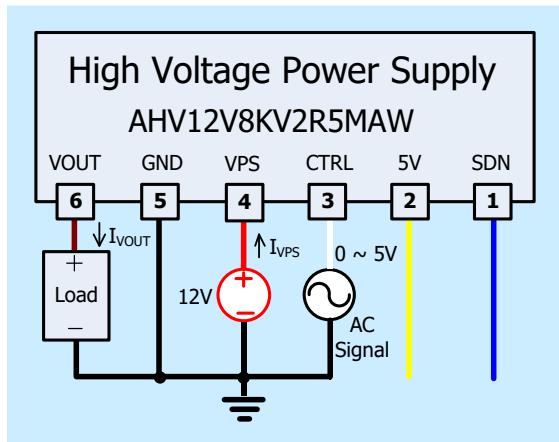

Figure 4. Modulating Output by an AC Signal Source

Please note that the modulation signal must have a low frequency $\leq 12\text{Hz}$ and the value range must be $0\text{V} \leq V_{CTRL} \leq 5\text{V}$. The equivalent input circuit for the CTRL is shown in Figure 5.

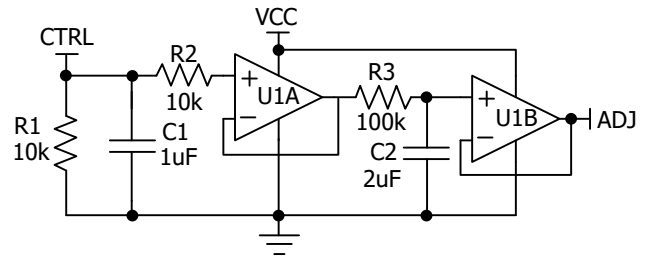

Figure 5. The Equivalent Circuit for CTRL Port

To shutdown AHV12V8KV2R5MAW, pull down SDN pin to $<0.8\text{V}$; to turn it on, leave SDN pin unconnected or pull it $>1.2\text{V}$. The maximum voltage allowed on the SDN pin is 5V. The equivalent circuit for SDN port is shown in Figure 6.

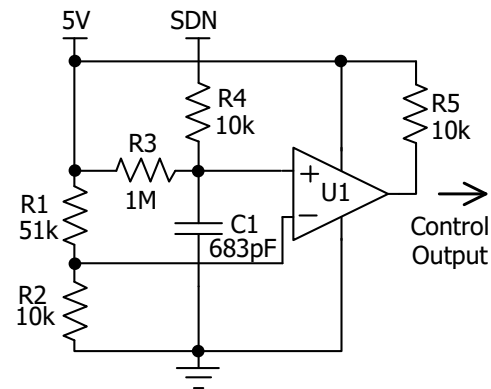

Figure 6. The Equivalent Circuit for SDN Port

USING AHV12V8KV2R5MAW

This high voltage power supply must be mounted tightly onto a metal plate, ideally, thus expanding its heating sinking capacity of the metal enclosure. Sufficient ventilation must be provided to keep the power supply surface temperature under 55°C .

SAFETY PRECAUTIONS

Although AHV12V8KV2R5MAW high voltage power supply comes with an over current protection circuit, a short circuit at the output should always be avoided. Make sure the high voltage wire for connecting VOUT node has sufficient insulation capability with its surrounding objects.

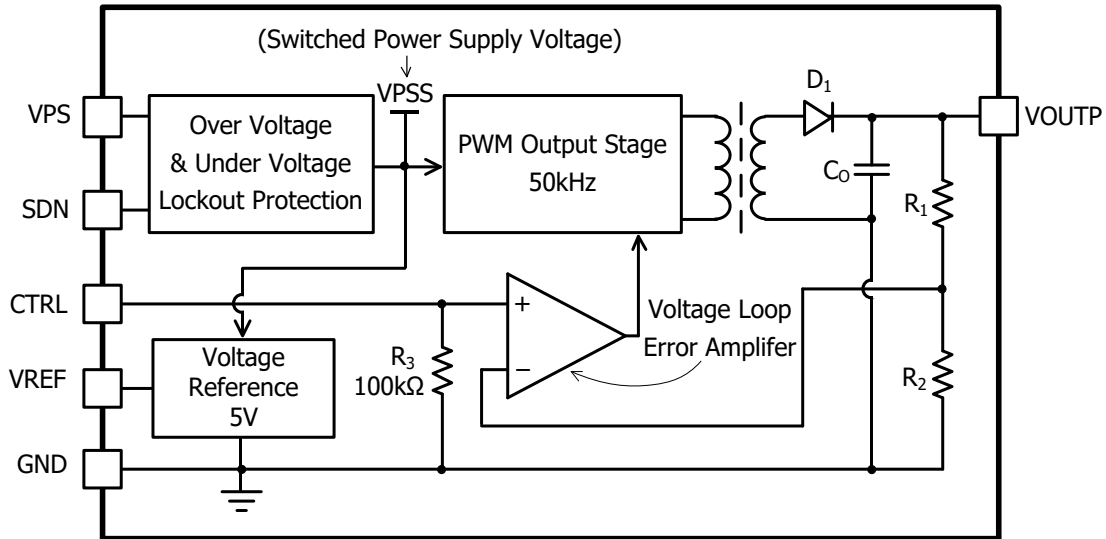

$V_{OUTP} = N \times V_{CTRL}$, where N is the amplification factor: $N = R_1/R_2$.

High Voltage Power Supply Function Block Diagram

SPECIFICATIONS

Table 2. Characteristics. $T_A = 25^\circ\text{C}$, unless otherwise noted.

Parameter	Symbol	Test Conditions	Min.	Typ.	Max.	Unit/Note
Input Power Supply Voltage	V_{VPS}		11	12	13	V
Input Power Supply Quiescent Current	I_{VPS_QC}	$I_{VOUT} = 0\text{mA}$ $V_{SDN} = V_{CTRL} = 5\text{V}$	575	600	625	mA
Input Power Supply Current at Full Load	I_{VPS_FL}	$I_{VOUT} = 2.5\text{mA}$	2.3	2.4	2.5	A
Input Power Supply Current at Shutdown	I_{VPS_SHDN}	$T_A = -10^\circ\text{C} \sim 55^\circ\text{C}$		13		mA
Modulation Voltage Range on CTRL	V_{CTRL}		0		5	V
Modulation Frequency Range on CTRL	f_{CTRL}		0		12	Hz
Shutdown Port Current	I_{SDNL}	$0 \leq V_{SDNL} < 0.8\text{V}$	4		4.8	μA
	I_{SDNH}	$1.2\text{V} < V_{SDNL} < 5\text{V}$	0		3.6	μA
Shutdown Voltage Logic Low	V_{SDNL}		0		0.8	V
Shutdown Voltage Logic High	V_{SDNH}		1.2		5	V
Output Voltage Range	V_{VOUT}	$I_{VOUT} = 0 \sim 2.5\text{mA}$	0		8000	V
Output Current Range	$I_{VOUTMAX}$	$V_{VPS} = 11\text{V} \sim 13\text{V}$	0		2.5	mA
Reference Output Voltage Range	V_{5VR}	$T_A = -10^\circ\text{C} \sim 55^\circ\text{C}$ $I_{5VR} \leq 1\text{mA}$	4.98	5	5.02	V
Reference Output Current Range	I_{5VR}	$T_A = -10^\circ\text{C} \sim 55^\circ\text{C}$ $V_{5VR} = 0 \sim 5\text{V}$	0		1	mA



Parameter		Symbol	Test Conditions	Min.	Typ.	Max.	Unit/Note
Output Load Resistance Range				$\frac{V_{VOUT}}{I_{VOUT}}$		∞	M Ω
Output Voltage Ripple		V_{VOUT_RP}	Bandwidth = 1MHz $R_{LOAD} = 3.2M\Omega$ $V_{VOUT} = 8000V$	≤ 4			V_{P-P}
Output Voltage Temperature Coefficient		TCV_{VOUT}	$V_{VPS} = 12V$ $V_{CTRL} = V_{5VR} = 5V$ $V_{VOUT} = 8000V$ $I_{VOUT} = 2.5mA$ $T_A = -10^{\circ}C \sim 55^{\circ}C$		≤ 0.01		%/ $^{\circ}C$
Output Voltage Range v.s. Temperature		$V_{VOUT}(T)$	$V_{VPS} = 12V$ $V_{CTRL} = V_{5VR} = 5V$ $V_{VOUT} = 8000V$ $I_{VOUT} = 2.5mA$ $T_A = -10^{\circ}C \sim 55^{\circ}C$	$0.99V_{VOUT}$	V_{VOUT}	$1.01V_{VOUT}$	V
Output Voltage Drift	Short Term Drift	$\frac{ \Delta V_{VOUT} }{V_{VOUT}}$ Δt (min)	$V_{VPS} = 12V$ $V_{CTRL} = V_{5VR} = 5V$ $V_{VOUT} = 8000V$ $I_{VOUT} = 2.5mA$ $T_A = -10^{\circ}C \sim 55^{\circ}C$		≤ 0.5		%/min
	Long Term Drift	$\frac{ \Delta V_{VOUT} }{V_{VOUT}}$ Δt (h)			≤ 1		%/h
Output Voltage Rise Time		t_r	$V_{VOUT}(t_1) = 800V$ $V_{VOUT}(t_2) = 7200V$ $R_{Load} = 3.2M\Omega$		50		ms
Output Voltage Fall Time		t_f	$V_{VOUT}(t_2) = 7200V$ $V_{VOUT}(t_3) = 800V$ $R_{Load} = 3.2M\Omega$		100		ms
Mean Time Between Failure		MTBF			1M		h
Instantaneous Short Circuit Current at the Output		I_{VOUT_SC}			≤ 250		mA
Load Regulation		$\frac{ \Delta V_{VOUT} }{V_{VOUT}}$ ΔI_{VOUT}	$V_{VOUT} = 8000V$ $I_{VOUT} = 2.5mA$		≤ 0.05		%/mA
Full Load Efficiency		η	$V_{VPS} = 12V$ $V_{VOUT} = 8000V$ $I_{VOUT} = 2.5mA$		≥ 70		%
Operating Temperature Range		T_{opr}		-10		55	$^{\circ}C$
Storage Temperature Range		T_{stg}		-20		85	$^{\circ}C$
External Dimensions				82×55×28			mm
				3.23×2.17×1.10			inch
Weight					210		g
					0.46		lbs
					7.4		Oz



TESTING DATA

Test conditions: $V_{PS} = 12V$, $T_A = 25^{\circ}C$, $R_{LOAD} = 3.2M\Omega$

DC Testing

The measured output voltage, V_{OUT} , corresponding to the control port input voltage, V_{CTRL} , is shown in Figure 7.

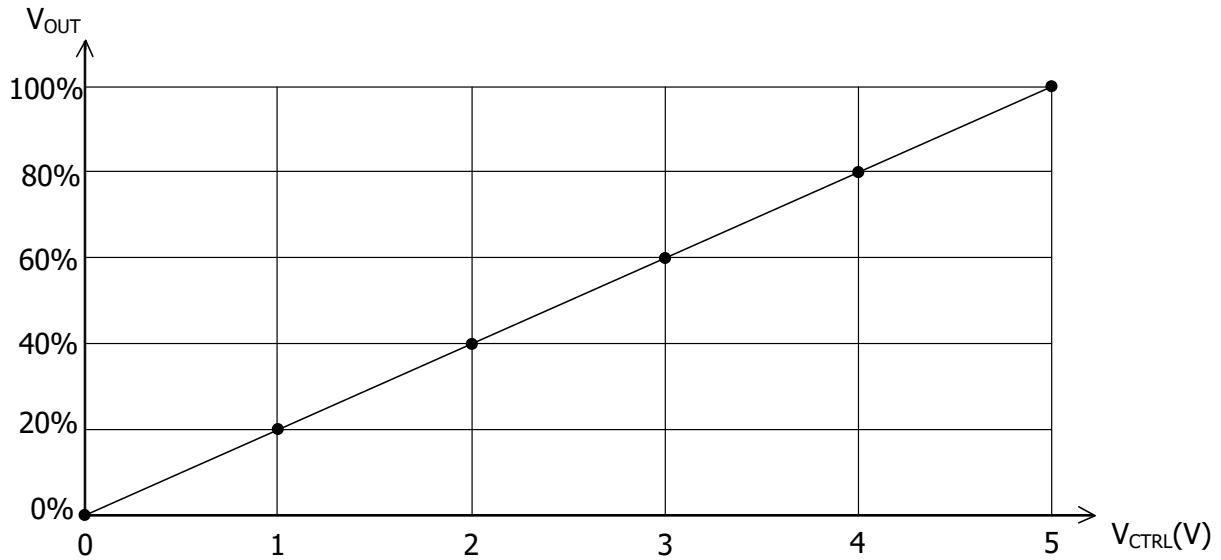

Figure 7. V_{CTRL} vs. V_{OUT}

AC Testing

To test the analog modulation function, a triangle and sine-wave voltage signals are applied to the CTRL port as the input source signal respectively. Figure 8 and 9 show both the input signal and the output signal waveforms when using the triangle and sine-wave signals at the CTRL port respectively.

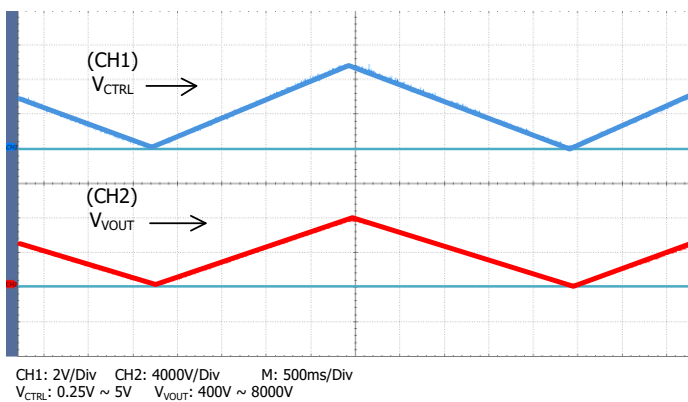

Figure 8. Triangle Wave Modulation

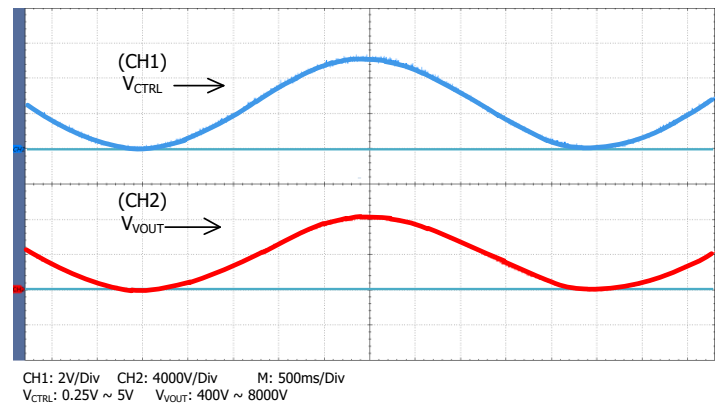

Figure 9. Input vs. Sine Wave Modulation



To test the rise and fall times at the output, a step function signal is applied to the CTRL port. The testing results are shown in Figure 10, Figure 11, and Figure 12. As shown in Figure 11 and Figure 12, a square wave of 0.25V ~ 5V, f = 0.10Hz, is applied to CTRL port, the output waveform fall time is measured to be about 100ms and the rise time is about 50ms. These two values are not the same, that is because on the rising trail, the power supply injects a current to the load; while on the falling trail, the best the power supply can do is to stop its output current and let the load resistor drain the output filtering capacitor to a lower voltage, and the draining current is much smaller than the injection current.

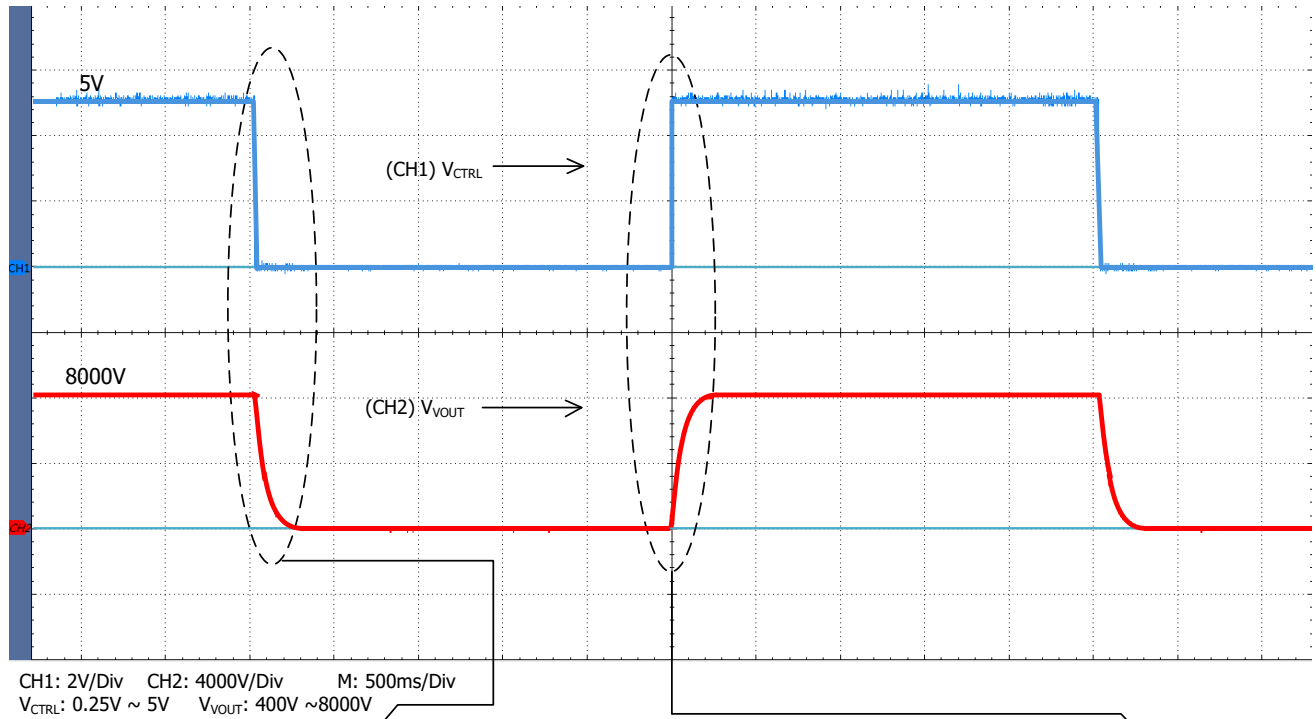

Figure 10. Input vs. Output Waveforms for Square Wave Control

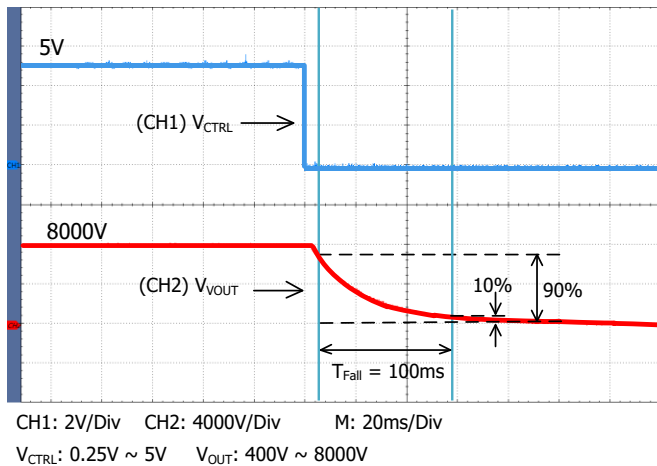

Figure 11. Falling Trail for Large Signal Response

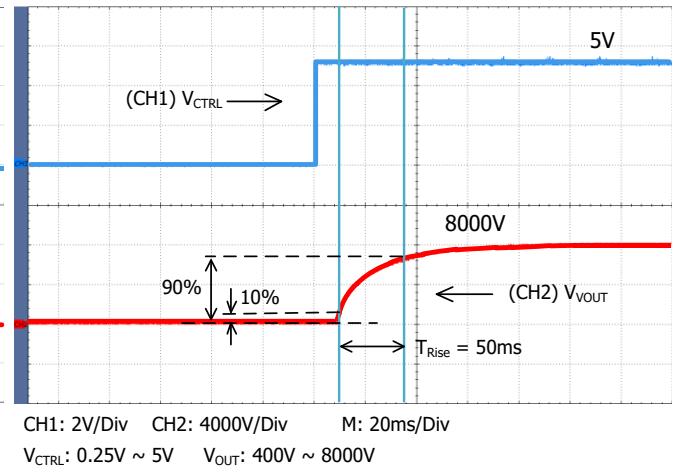
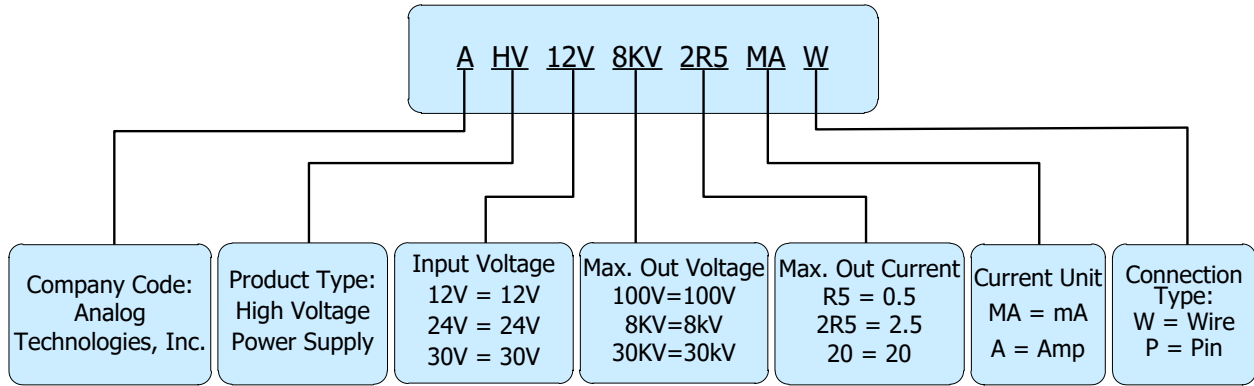

Figure 12. Rising Trail for Large Signal Response



NAMING PRINCIPLE



Naming Principle of AHV12V8KV2R5MAW

DIMENSIONS

Connecting Lead Wire Sizes and Lengths

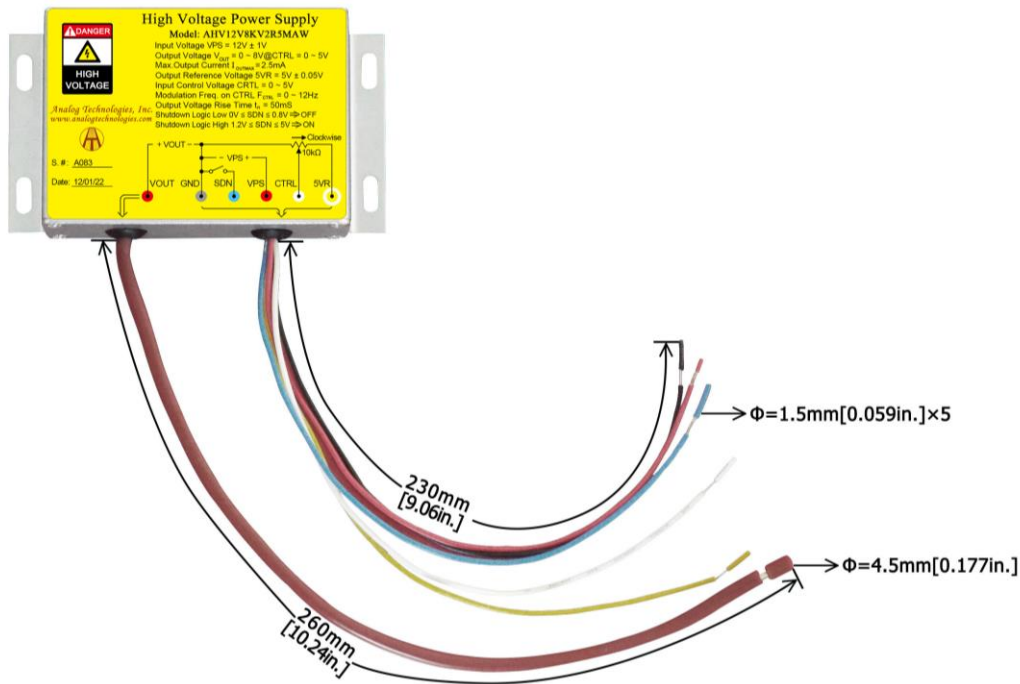

Figure 13. Connecting Lead Wires of AHV12V8KV2R5MAW

Lead Wires	Diameter		Length	
	mm	inch	mm	inch
Thick brown lead wire	4.5	0.177	260 ± 1	10.24 ± 0.039
Yellow, red, blue, black and white lead wires	1.5	0.059	230 ± 1	9.06 ± 0.039



Outline Dimensions

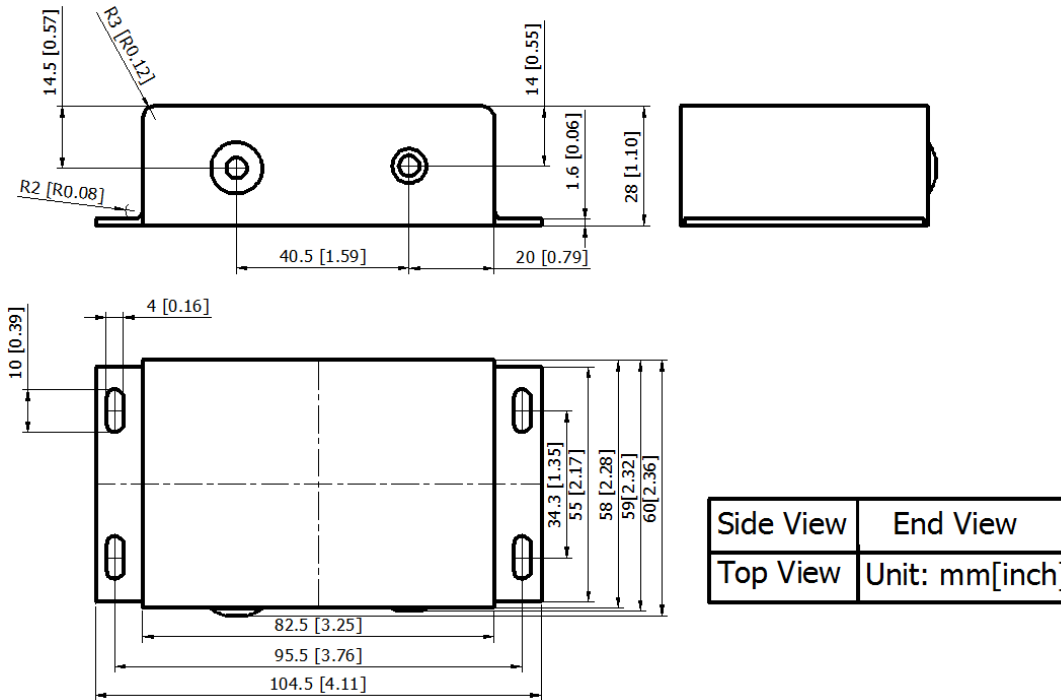

Figure 14. Outline Dimensions

ORDERING INFORMATION

Part Number	Buy Now
AHV12V8KV2R5MAW	



RELATED PRODUCTS

































Input Voltage: 12V, Input Control Voltage: 0 to 5V, Efficiency: 70%.



Table with 6 columns: Part #, Datasheet, Output Voltage (V), Output Current (mA), Description, Buy Now*. Rows list various high voltage power supply models like AHV12V500V1MAW, AHV12V1KV1MAW, etc.



Part #	Datasheet	Output Voltage (V)	Output Current (mA)	Description	Buy Now*
AHV12V4KV2R5MAW		4000	2.5	Positive 4kV 2.5mA module with lead wires	* *
AHV12V4KV5MAW		4000	5	Positive 4kV 5mA module with lead wires	* *
AHV12V5KV1MAW		5000	1	Positive 5kV 1mA module with lead wires	* *
AHV12V5KV2MAW		5000	2	Positive 5kV 2mA module with lead wires	* *
AHV12V5KV4MAW		5000	4	Positive 5kV 4mA module with lead wires	* *
AHV12V6KV1MAW		6000	1	Positive 6kV 1mA module with lead wires	* *
AHV12V6KV3MAW		6000	3	Positive 6kV 3mA module with lead wires	* *
AHV12V7KV1MAW		7000	1	Positive 7kV 1mA module with lead wires	* *
AHV12V7KV2MAW		7000	2	Positive 7kV 2mA module with lead wires	* *
AHV12V8KV1MAW		8000	1	Positive 8kV 1mA module with lead wires	* *
AHV12V8KV2R5MAW	Contact Us	8000	2.5	Positive 8kV 2.5mA module with lead wires	Contact Us
AHV12V9KV1MAW		9000	1	Positive 9kV 1mA module with lead wires	* *
AHV12V10KV1MAW		10,000	1	Positive 10kV 1mA module with lead wires	* *
AHV12V30KVR7MAW		30,000	0.7	Positive 30kV 0.7mA module with lead wires	* *
AHV12VN500V1MAW	Contact Us	-500	1	Negative 500V 1mA module with lead wires	Contact Us
AHV12VN500V2MAW	Contact Us	-500	2	Negative 500V 2mA module with lead wires	Contact Us
AHV12VN500V5MAW	Contact Us	-500	5	Negative 500V 5mA module with lead wires	Contact Us
AHV12VN500V10MAW	Contact Us	-500	10	Negative 500V 10mA module with lead wires	Contact Us
AHV12VN500V20MAW	Contact Us	-500	20	Negative 500V 20mA module with lead wires	Contact Us
AHV12VN1KV1MAW		-1000	1	Negative 1kV 1mA module with lead wires	* *
AHV12VN1KV2MAW	Contact Us	-1000	2	Negative 2kV 1mA module with lead wires	Contact Us
AHV12VN1KV3MAW		-1000	3	Negative 1kV 3mA module with lead wires	* *
AHV12VN1KV5MAW		-1000	5	Negative 1kV 5mA module with lead wires	* *
AHV12VN1KV10MAW		-1000	10	Negative 1kV 10mA module with lead wires	* *
AHV12VN1KV20MAW		-1000	20	Negative 1kV 20mA module with lead wires	* *
AHV12VN1500V1MAW	Contact Us	-1500	1	Negative 1.5kV 1mA module with lead wires	Contact Us
AHV12VN1500V2MAW	Contact Us	-1500	2	Negative 1.5kV 2mA module with lead wires	Contact Us
AHV12VN1500V5MAW	Contact Us	-1500	5	Negative 1.5kV 5mA module with lead wires	Contact Us
AHV12VN1500V10MAW	Contact Us	-1500	10	Negative 1.5kV 10mA module with lead wires	Contact Us
AHV12VN2KV1MAW		-2000	1	Negative 2kV 1mA module with lead wires	* *



Part #	Datasheet	Output Voltage (V)	Output Current (mA)	Description	Buy Now*
AHV12VN2KV3MAW	Contact Us	-2000	3	Negative 2kv 3mA module with lead wires	Contact Us
AHV12VN2KV5MAW	Contact Us	-2000	5	Negative 2kv 5mA module with lead wires	Contact Us
AHV12VN2KV10MAW	Contact Us	-2000	10	Negative 2kv 10mA module with lead wires	Contact Us
AHV12VN2500V1MAW	Contact Us	-2500	1	Negative 2.5kv 1mA module with lead wires	Contact Us
AHV12VN2500V3MAW	Contact Us	-2500	3	Negative 2.5kv 3mA module with lead wires	Contact Us
AHV12VN2500V5MAW	Contact Us	-2500	5	Negative 2.5kv 5mA module with lead wires	Contact Us
AHV12VN3KV1MAW		-3000	1	Negative 3kv 1mA module with lead wires	 *  *
AHV12VN3KV3MAW		-3000	3	Negative 3kv 3mA module with lead wires	 *  *
AHV12VN3KV5MAW		-3000	5	Negative 3kv 5mA module with lead wires	 *  *
AHV12VN3KV10MAW		-3000	10	Negative 3kv 10mA module with lead wires	 *  *
AHV12VN4KV1MAW		-4000	1	Negative 4kv 1mA module with lead wires	 *  *
AHV12VN4KV2R5MAW	Contact Us	-4000	2.5	Negative 4kv 2.5mA module with lead wires	Contact Us
AHV12VN4KV5MAW	Contact Us	-4000	5	Negative 4kv 5mA module with lead wires	Contact Us
AHV12VN5KV1MAW		-5000	1	Negative 5kv 1mA module with lead wires	 *  *
AHV12VN5KV2MAW	Contact Us	-5000	2	Negative 5kv 2mA module with lead wires	Contact Us
AHV12VN5KV4MAW	Contact Us	-5000	4	Negative 5kv 4mA module with lead wires	Contact Us
AHV12VN6KV1MAW		-6000	1	Negative 6kv 1mA module with lead wires	 *  *
AHV12VN6KV3MAW	Contact Us	-6000	3	Negative 6kv 3mA module with lead wires	Contact Us
AHV12VN7KV1MAW		-7000	1	Negative 7kv 1mA module with lead wires	 *  *
AHV12VN7KV2MAW	Contact Us	-7000	2	Negative 7kv 2mA module with lead wires	Contact Us
AHV12VN8KV1MAW		-8000	1	Negative 8kv 1mA module with lead wires	 *  *
AHV12VN8KV2R5MAW		-8000	2.5	Negative 8kv 2.5mA module with lead wires	 *  *
AHV12VN9KV1MAW		-9000	1	Negative 9kv 1mA module with lead wires	 *  *
AHV12VN10KV1MAW		-10000	1	Negative 10kv 1mA module with lead wires	 *  *

*: both  and  are our online store icons. Our products can be ordered from either one of them with the same pricing and delivery time.



NOTICE

1. ATI warrants performance of its products for one year to the specifications applicable at the time of sale, except for those being damaged by excessive abuse. Products found not meeting the specifications within one year from the date of sale can be exchanged free of charge.
2. ATI reserves the right to make changes to its products or to discontinue any product or service without notice, and advise customers to obtain the latest version of relevant information to verify, before placing orders, that the information being relied on is current and complete.
3. All products are sold subject to the terms and conditions of sale supplied at the time of order acknowledgment, including those pertaining to warranty, patent infringement, and limitation of liability. Testing and other quality control techniques are utilized to the extent ATI deems necessary to support this warranty. Specific testing of all parameters of each device is not necessarily performed, except those mandated by government requirements.
4. Customers are responsible for their applications using ATI products. In order to minimize risks associated with the customers' applications, adequate design and operating safeguards must be provided by the customers to minimize inherent or procedural hazards. ATI assumes no liability for applications assistance or customer product design.
5. ATI does not warrant or represent that any license, either express or implied, is granted under any patent right, copyright, mask work right, or other intellectual property right of ATI covering or relating to any combination, machine, or process in which such products or services might be or are used. ATI's publication of information regarding any third party's products or services does not constitute ATI's approval, warranty or endorsement thereof.
6. IP (Intellectual Property) Ownership: ATI retains the ownership of full rights for special technologies and/or techniques embedded in its products, the designs for mechanics, optics, plus all modifications, improvements, and inventions made by ATI for its products and/or projects.