

CARMEN-S-C

~14° spot beam. Assembly with holder C compatible with LEDiL HEKLA.

SPECIFICATION:

Dimensions	Ø 69.5 mm
Height	41.5 mm
Fastening	socket
ROHS compliant	yes ⓘ



MATERIALS:

Component	Type	Material	Colour	Finish
CARMEN-S	Single lens	PMMA	clear	
CARMEN-HLD-C	Holder	PC	black	





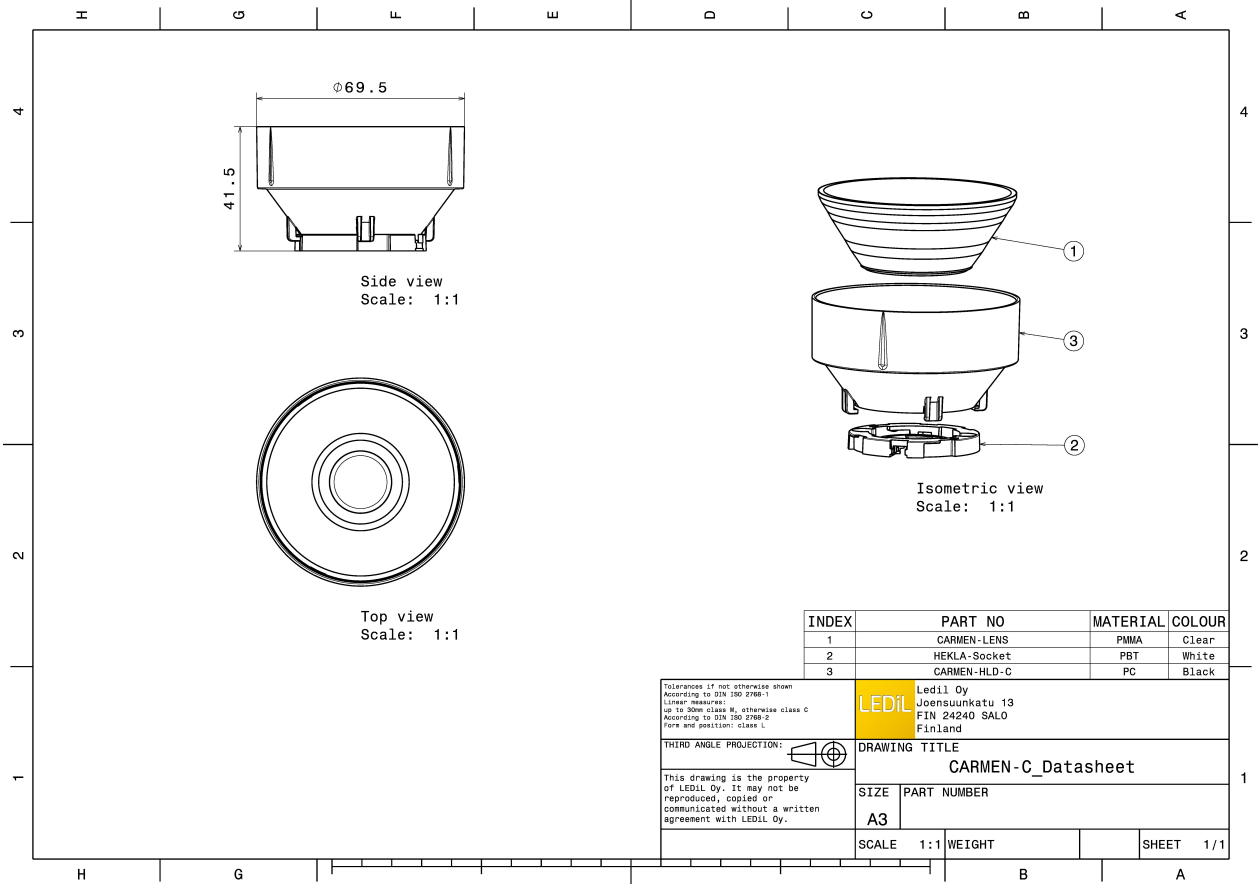



ORDERING INFORMATION:

Component	Type	Qty in box	MOQ	MPQ	Box weight (kg)
CP15774_CARMEN-S-C	Single lens	150	150	15	4.5
» Box size: 476 x 273 x 292 mm					

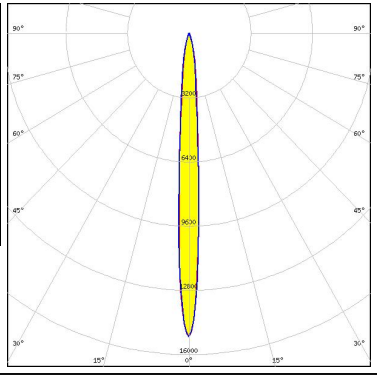

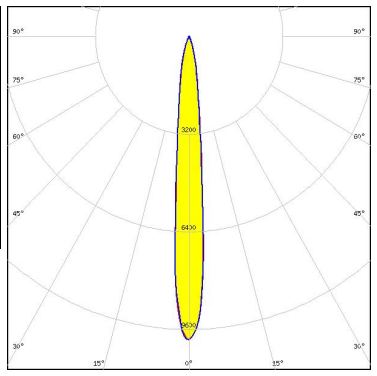

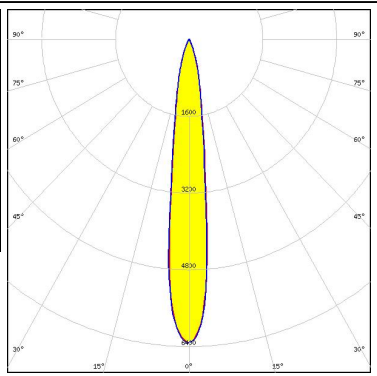

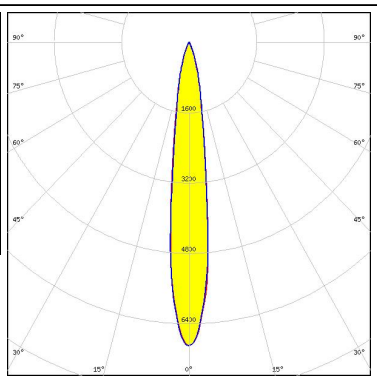

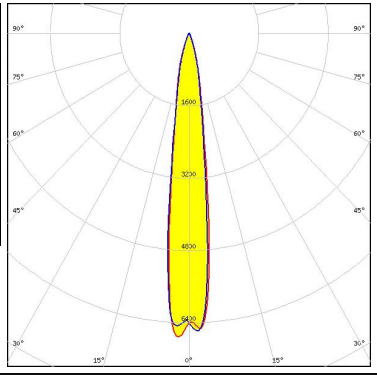

See also our general installation guide: www.ledil.com/installation_guide

OPTICAL RESULTS (MEASURED):

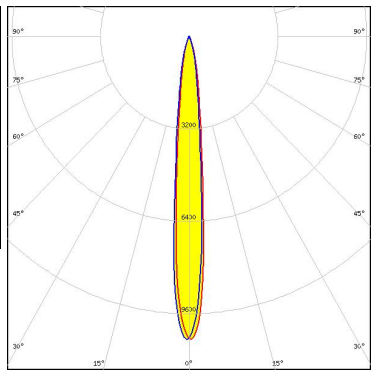
<p></p> <p>LED V4 HD Gen 7</p> <p>FWHM / FWTM 8.0° / 23.0°</p> <p>Efficiency 78 %</p> <p>Peak intensity 15 cd/lm</p> <p>LEDs/each optic 1</p> <p>Light colour White</p> <p>Required components: F15253_HEKLA-SOCKET-A</p>		
<p></p> <p>LED V6 HD Gen 7</p> <p>FWHM / FWTM 10.0° / 28.0°</p> <p>Efficiency 75 %</p> <p>Peak intensity 9.9 cd/lm</p> <p>LEDs/each optic 1</p> <p>Light colour White</p> <p>Required components: F15255_HEKLA-SOCKET-C</p>		
<p></p> <p>LED V9 HD Gen7</p> <p>FWHM / FWTM 14.0° / 34.0°</p> <p>Efficiency 72 %</p> <p>Peak intensity 6.3 cd/lm</p> <p>LEDs/each optic 1</p> <p>Light colour White</p> <p>Required components: F15859_HEKLA-SOCKET-I</p>		
<p></p> <p>LED VERO10</p> <p>FWHM / FWTM 14.0° / 34.0°</p> <p>Efficiency 75 %</p> <p>Peak intensity 6.9 cd/lm</p> <p>LEDs/each optic 1</p> <p>Light colour White</p> <p>Required components: F15616_HEKLA-SOCKET-F</p>		

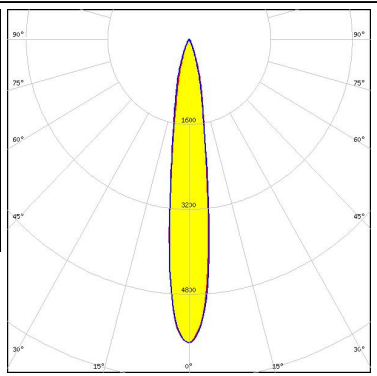
OPTICAL RESULTS (MEASURED):

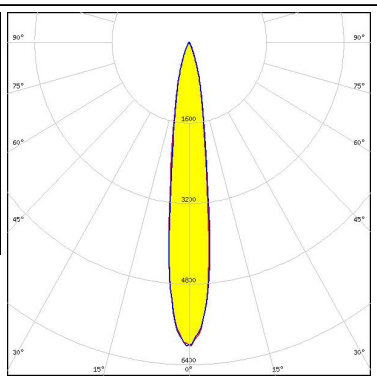
<p></p> <p>LED Vesta DTW 9mm (4W/6W/12W)</p> <p>FWHM / FWTM 14.0° / 33.0°</p> <p>Efficiency 71 %</p> <p>Peak intensity 6.8 cd/lm</p> <p>LEDs/each optic 1</p> <p>Light colour White</p> <p>Required components: C16142_HEKLA-SOCKET-K Bender Wirth: 490 Typ L8</p>		
<p></p> <p>LED Vesta TW 6mm DP</p> <p>FWHM / FWTM 11.0° / 27.0°</p> <p>Efficiency 75 %</p> <p>Peak intensity 10.5 cd/lm</p> <p>LEDs/each optic 1</p> <p>Light colour White</p> <p>Required components: C16142_HEKLA-SOCKET-K Bender Wirth: 504 Typ L8</p>		
<p></p> <p>LED Vesta TW 9mm (9W) DP</p> <p>FWHM / FWTM 15.0° / 36.0°</p> <p>Efficiency 71 %</p> <p>Peak intensity 5.7 cd/lm</p> <p>LEDs/each optic 1</p> <p>Light colour White</p> <p>Required components: C16142_HEKLA-SOCKET-K Bender Wirth: 489 Typ L8</p>		
<p>CITIZEN</p> <p>LED CLL02x/CLU02x (LES10)</p> <p>FWHM / FWTM 15.0° / 36.0°</p> <p>Efficiency 74 %</p> <p>Peak intensity 6 cd/lm</p> <p>LEDs/each optic 1</p> <p>Light colour White</p> <p>Required components: F15255_HEKLA-SOCKET-C</p>		

OPTICAL RESULTS (MEASURED):

CITIZEN

LED CLU700/701/702/703
 FWHM / FWTM 10.0° / 25.0°
 Efficiency 78 %
 Peak intensity 12.7 cd/lm
 LEDs/each optic 1
 Light colour White
 Required components:
 F15255_HEKLA-SOCKET-C

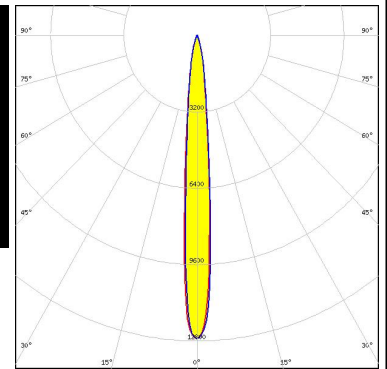
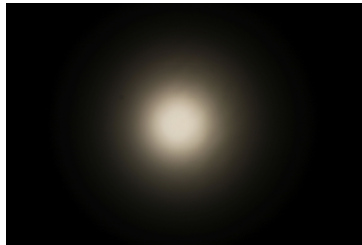

CITIZEN

LED CLU710/711
 FWHM / FWTM 13.0° / 33.0°
 Efficiency 73 %
 Peak intensity 7.2 cd/lm
 LEDs/each optic 1
 Light colour White
 Required components:
 F15859_HEKLA-SOCKET-I

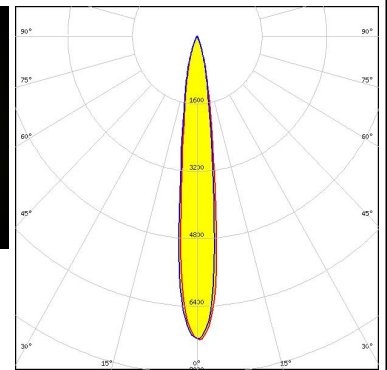

CITIZEN

LED CLU7A2/7A3
 FWHM / FWTM 7.0° / 20.0°
 Efficiency 80 %
 Peak intensity 18.5 cd/lm
 LEDs/each optic 1
 Light colour White
 Required components:
 F15255_HEKLA-SOCKET-C

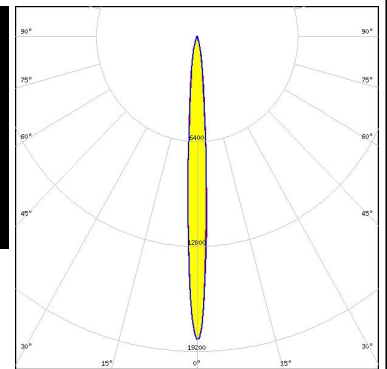
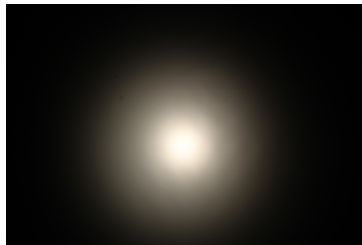





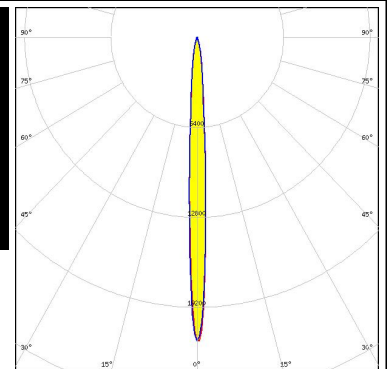
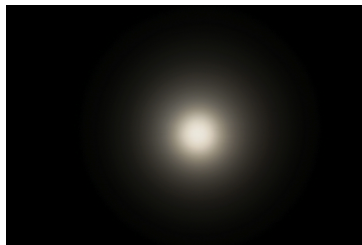

CITIZEN

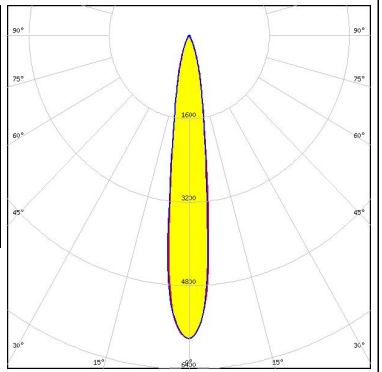

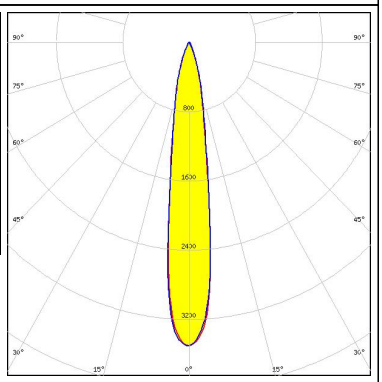

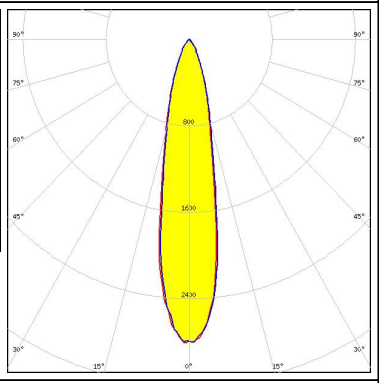
LED CLU7B2
 FWHM / FWTM 6.0° / 19.0°
 Efficiency 80 %
 Peak intensity 21.7 cd/lm
 LEDs/each optic 1
 Light colour White
 Required components:
 F15255_HEKLA-SOCKET-C

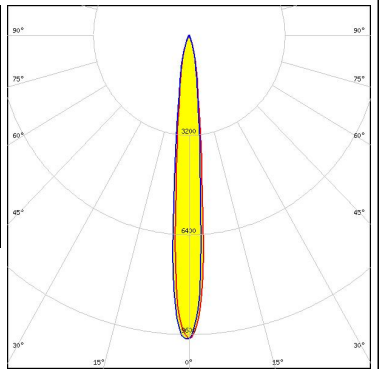

OPTICAL RESULTS (MEASURED):

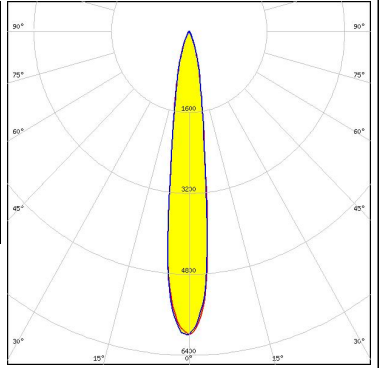
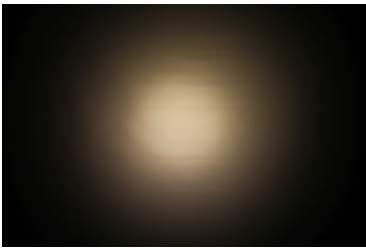
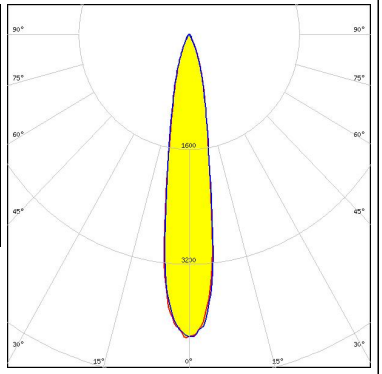
<p>CREE LED</p> <p>LED CMA1516 FWHM / FWTM 14.0° / 36.0° Efficiency 72 % Peak intensity 5.8 cd/m LEDs/each optic 1 Light colour White Required components: F15256_HEKLA-SOCKET-D</p>		
<p>CREE LED</p> <p>LED CMT14xx FWHM / FWTM 15.0° / 37.0° Efficiency 48 % Peak intensity 3.5 cd/m LEDs/each optic 1 Light colour White Required components: F15255_HEKLA-SOCKET-C</p>		
<p>LUMILEDS</p> <p>LED LUXEON CX Plus CoB L08 (Gen2) FWHM / FWTM 21.0° / 50.0° Efficiency 67 % Peak intensity 2.8 cd/m LEDs/each optic 1 Light colour White Required components: Bender Wirth: 637a Hekla</p>		
<p>LUMILEDS</p> <p>LED LUXEON CoB 1202HD FWHM / FWTM 10.0° / 28.0° Efficiency 75 % Peak intensity 9.8 cd/m LEDs/each optic 1 Light colour White Required components: F15848_HEKLA-SOCKET-G</p>		

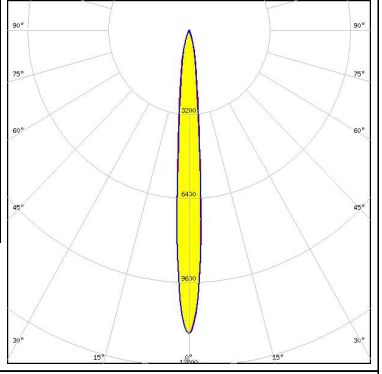
OPTICAL RESULTS (MEASURED):

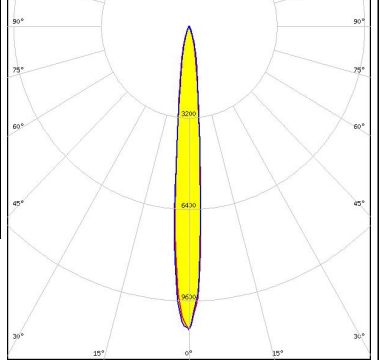
<p>LUMILEDS</p> <p>LED LUXEON CoB 1204HD</p> <p>FWHM / FWTM 14.0° / 35.0°</p> <p>Efficiency 73 %</p> <p>Peak intensity 6 cd/lm</p> <p>LEDs/each optic 1</p> <p>Light colour White</p> <p>Required components: F15858_HEKLA-SOCKET-H</p>		
<p>LUMILEDS</p> <p>LED LUXEON CoB 1205HD</p> <p>FWHM / FWTM 17.0° / 41.0°</p> <p>Efficiency 69 %</p> <p>Peak intensity 4.2 cd/lm</p> <p>LEDs/each optic 1</p> <p>Light colour White</p> <p>Required components: F15858_HEKLA-SOCKET-H</p>		
<p>LUMILEDS</p> <p>LED LUXEON CX Plus CoB - HD S01H4</p> <p>FWHM / FWTM 9.0° / 26.0°</p> <p>Efficiency 75 %</p> <p>Peak intensity 11.6 cd/lm</p> <p>LEDs/each optic 1</p> <p>Light colour White</p> <p>Required components: Bender Wirth: 634c Hekla</p>		
<p>LUMILEDS</p> <p>LED LUXEON CX Plus CoB - HD S02H6</p> <p>FWHM / FWTM 10.0° / 26.0°</p> <p>Efficiency 75 %</p> <p>Peak intensity 10.6 cd/lm</p> <p>LEDs/each optic 1</p> <p>Light colour White</p> <p>Required components: Bender Wirth: 634c Hekla</p>		

OPTICAL RESULTS (MEASURED):

LUMILEDS

LED LUXEON CX Plus CoB - HD S04H9
 FWHM / FWTM 14.0° / 36.0°
 Efficiency 72 %
 Peak intensity 5.9 cd/lm
 LEDs/each optic 1
 Light colour White
 Required components:
 Bender Wirth: 634c Hekla

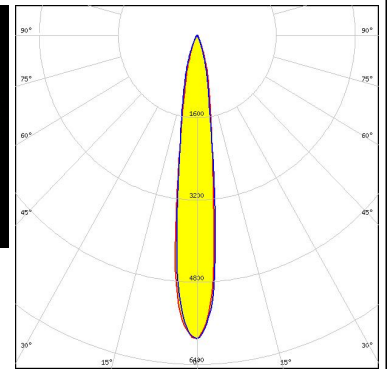

LUMILEDS

LED LUXEON CX Plus CoB L04 / L05 (Gen2)
 FWHM / FWTM 18.0° / 42.0°
 Efficiency 69 %
 Peak intensity 4.1 cd/lm
 LEDs/each optic 1
 Light colour White
 Required components:
 Bender Wirth: 637a Hekla

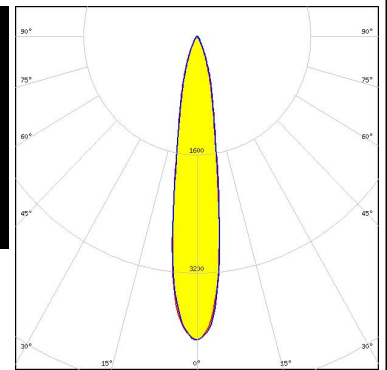
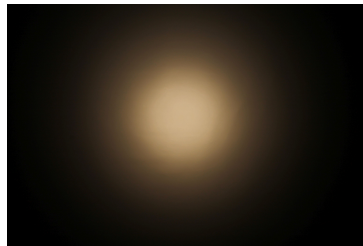

LUMILEDS

LED LUXEON CX Plus CoB M02 / M03 (Gen2)
 FWHM / FWTM 13.0° / 33.0°
 Efficiency 72 %
 Peak intensity 6.8 cd/lm
 LEDs/each optic 1
 Light colour White
 Required components:
 Bender Wirth: 641a Hekla

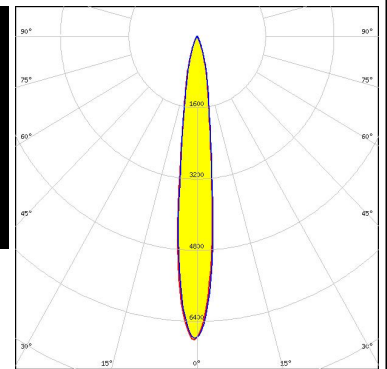

LUMILEDS

LED LUXEON CX Plus CoB S01 (Gen2)
 FWHM / FWTM 9.0° / 25.0°
 Efficiency 76 %
 Peak intensity 11.9 cd/lm
 LEDs/each optic 1
 Light colour White
 Required components:
 Bender Wirth: 634c Hekla

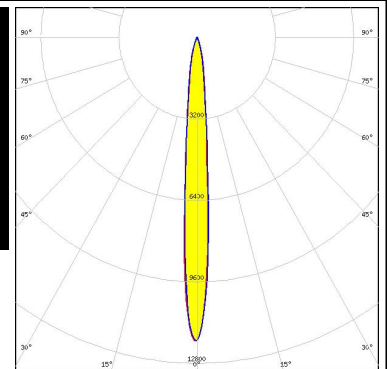

OPTICAL RESULTS (MEASURED):



LED CDM-9 (Dim-To-Warm)
 FWHM / FWTM 14.0° / 33.0°
 Efficiency 71 %
 Peak intensity 6.7 cd/lm
 LEDs/each optic 1
 Light colour White
 Required components:
 C16142_HEKLA-SOCKET-K
 Bender Wirth: 490 Typ L8

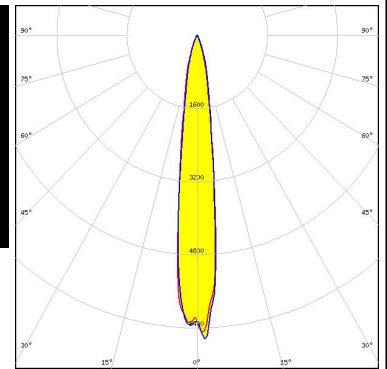

LED CxM-11 (19x19)
 FWHM / FWTM 18.0° / 42.0°
 Efficiency 70 %
 Peak intensity 4.2 cd/lm
 LEDs/each optic 1
 Light colour White
 Required components:
 F15859_HEKLA-SOCKET-I

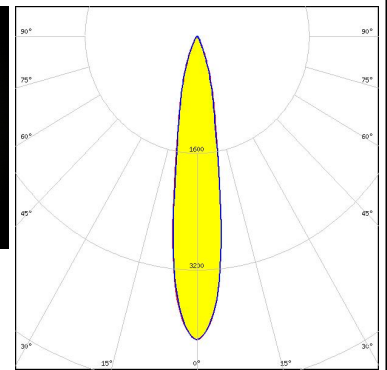



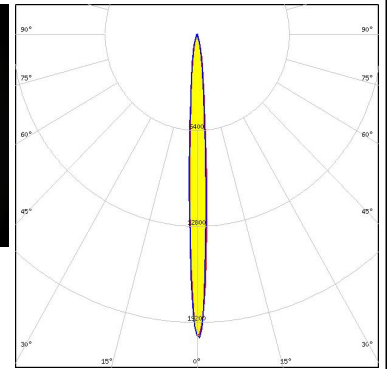

LED CXM-3
 FWHM / FWTM 7.0° / 19.0°
 Efficiency 80 %
 Peak intensity 20.2 cd/lm
 LEDs/each optic 1
 Light colour White
 Required components:
 F15255_HEKLA-SOCKET-C

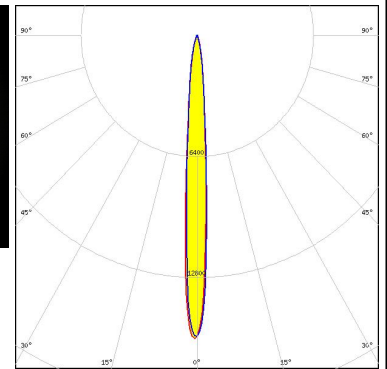

LED CXM-4
 FWHM / FWTM 8.0° / 22.0°
 Efficiency 78 %
 Peak intensity 16 cd/lm
 LEDs/each optic 1
 Light colour White
 Required components:
 F15255_HEKLA-SOCKET-C

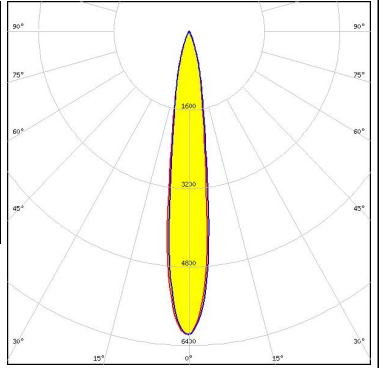

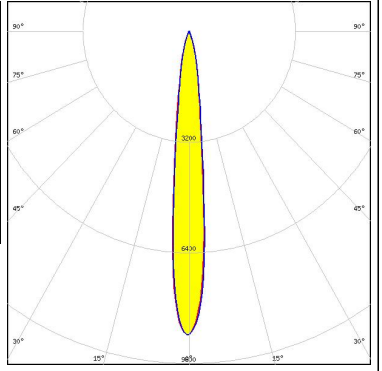
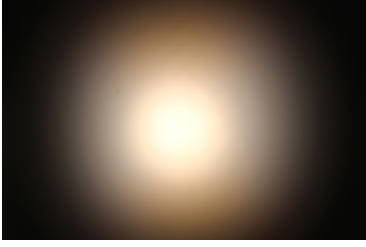
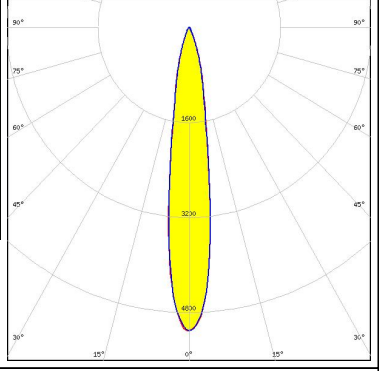
OPTICAL RESULTS (MEASURED):

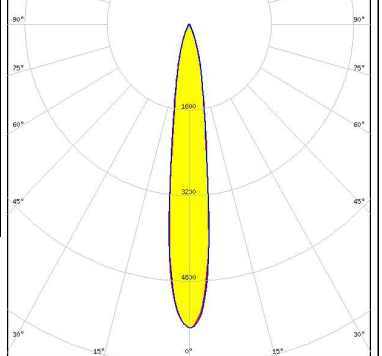
<p>LUMINUS</p> <p>LED CxM-9 (13.5x13.5)</p> <p>FWHM / FWTM 15.0° / 35.0°</p> <p>Efficiency 74 %</p> <p>Peak intensity 6.2 cd/m</p> <p>LEDs/each optic 1</p> <p>Light colour White</p> <p>Required components: F15255_HEKLA-SOCKET-C</p>		
<p>NICHIA</p> <p>LED NJCWL024Z-V1MT: COB L-Type Tunable White</p> <p>FWHM / FWTM 12.0° / 29.0°</p> <p>Efficiency 71 %</p> <p>Peak intensity 8.8 cd/m</p> <p>LEDs/each optic 1</p> <p>Light colour White</p> <p>Required components: C16142_HEKLA-SOCKET-K Bender Wirth: 497 Typ L8</p>		
<p>NICHIA</p> <p>LED NVCWJ024Z-V1MT: COB J-Type Tunable White</p> <p>FWHM / FWTM 16.0° / 37.0°</p> <p>Efficiency 69 %</p> <p>Peak intensity 5.1 cd/m</p> <p>LEDs/each optic 1</p> <p>Light colour White</p> <p>Required components: C16142_HEKLA-SOCKET-K Bender Wirth: 498 Typ L8</p>		
<p>PHILIPS</p> <p>LED Fortimo SLM L09 CoB</p> <p>FWHM / FWTM 15.0° / 36.0°</p> <p>Efficiency 72 %</p> <p>Peak intensity 5.7 cd/m</p> <p>LEDs/each optic 1</p> <p>Light colour White</p> <p>Required components: F15858_HEKLA-SOCKET-H</p>		

OPTICAL RESULTS (MEASURED):

SAMSUNG

LED LC003D / LC006D / LC009D / LC013D
 FWHM / FWTM 15.0° / 36.0°
 Efficiency 74 %
 Peak intensity 6 cd/lm
 LEDs/each optic 1
 Light colour White
 Required components:
 F15255_HEKLA-SOCKET-C

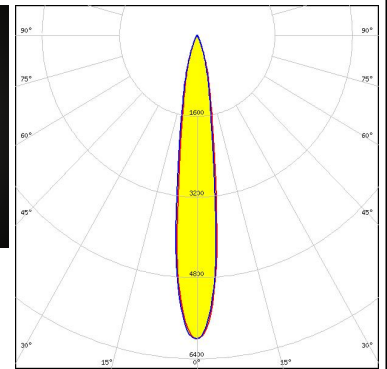
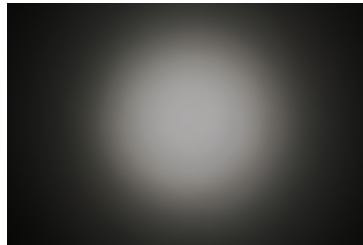

SAMSUNG

LED LC010C G2
 FWHM / FWTM 9.0° / 24.0°
 Efficiency 77 %
 Peak intensity 13.1 cd/lm
 LEDs/each optic 1
 Light colour White
 Required components:
 F15255_HEKLA-SOCKET-C

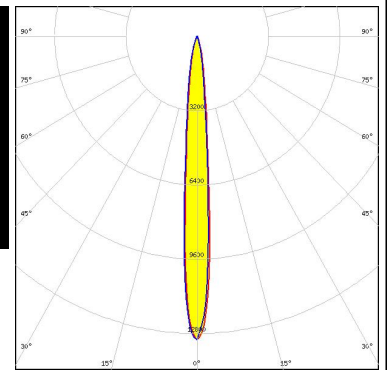

SAMSUNG

LED LC010T (Tunable White)
 FWHM / FWTM 15.0° / 35.0°
 Efficiency 71 %
 Peak intensity 5.8 cd/lm
 LEDs/each optic 1
 Light colour Tunable White
 Required components:
 C16142_HEKLA-SOCKET-K
 Bender Wirth: 501 Typ L8

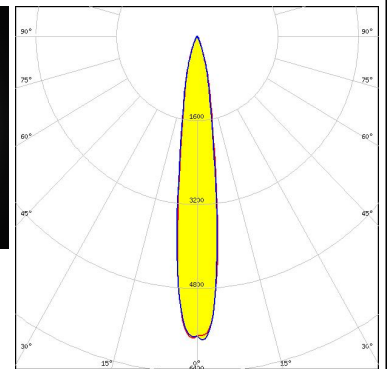

SAMSUNG

LED LC020C
 FWHM / FWTM 12.0° / 31.0°
 Efficiency 76 %
 Peak intensity 8.2 cd/lm
 LEDs/each optic 1
 Light colour White
 Required components:
 F15848_HEKLA-SOCKET-G

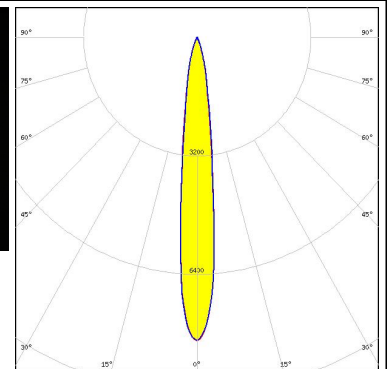
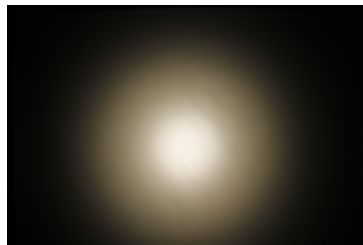

OPTICAL RESULTS (MEASURED):

SAMSUNG

LED LC020C G2
 FWHM / FWTM 14.0° / 33.0°
 Efficiency 74 %
 Peak intensity 6.9 cd/lm
 LEDs/each optic 1
 Light colour White
 Required components:
 F15859_HEKLA-SOCKET-I

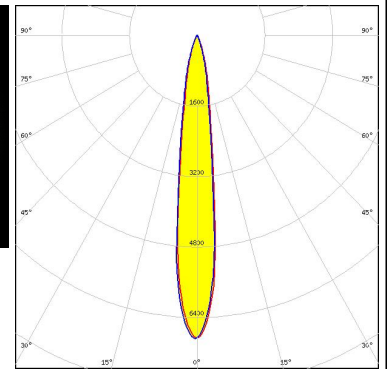

SEOUL SEMICONDUCTOR
 LED MJT COB LES 6
 FWHM / FWTM 9.0° / 23.0°
 Efficiency 76 %
 Peak intensity 13.1 cd/lm
 LEDs/each optic 1
 Light colour White
 Required components:
 F15255_HEKLA-SOCKET-C

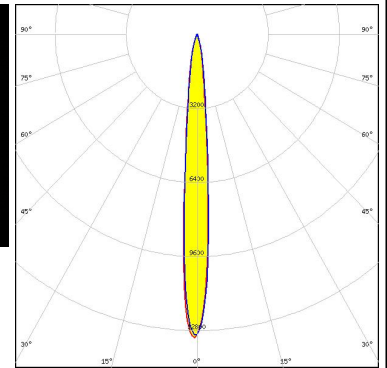

SEOUL SEMICONDUCTOR
 LED MJT COB LES 9.8
 FWHM / FWTM 15.0° / 35.0°
 Efficiency 72 %
 Peak intensity 5.9 cd/lm
 LEDs/each optic 1
 Light colour White
 Required components:
 F15255_HEKLA-SOCKET-C

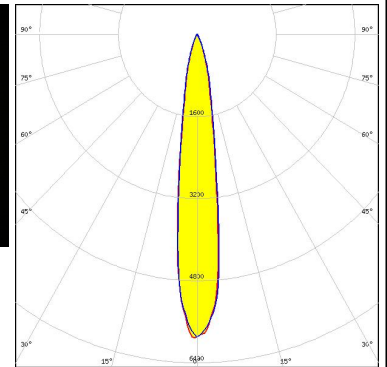
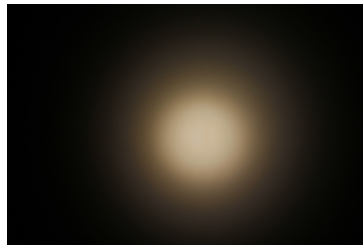

TRIDONIC

LED SLE G7 LES09
 FWHM / FWTM 14.0° / 34.0°
 Efficiency 74 %
 Peak intensity 6.7 cd/lm
 LEDs/each optic 1
 Light colour White
 Required components:
 F15255_HEKLA-SOCKET-C

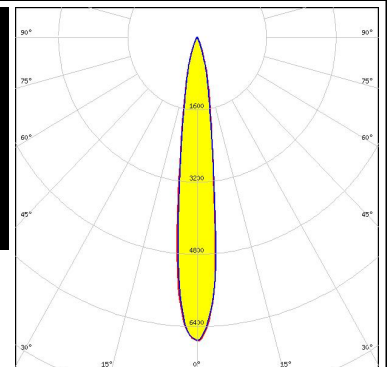

OPTICAL RESULTS (MEASURED):

TRIDONIC

LED SLE G7 LES13
 FWHM / FWTM 20.0° / 45.0°
 Efficiency 69 %
 Peak intensity 3.5 cd/lm
 LEDs/each optic 1
 Light colour White
 Required components:
 F15859_HEKLA-SOCKET-I

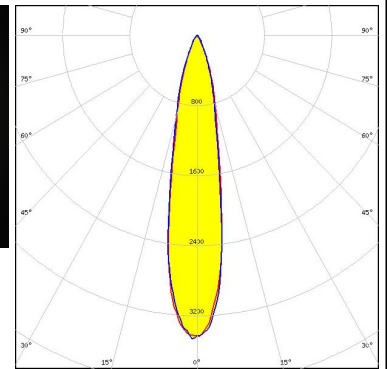
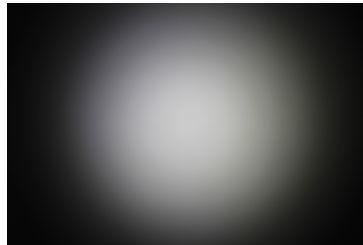

XICATO

LED XOB 6 mm
 FWHM / FWTM 10.0° / 26.0°
 Efficiency 76 %
 Peak intensity 11.4 cd/lm
 LEDs/each optic 1
 Light colour White
 Required components:
 F15255_HEKLA-SOCKET-C

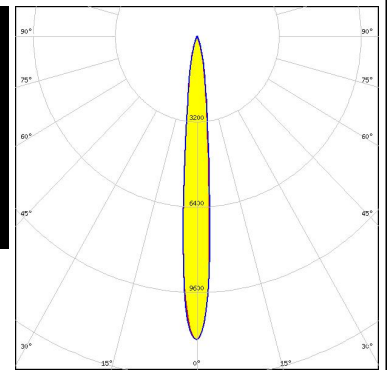
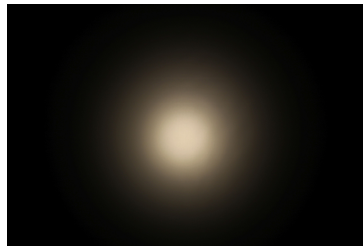

XICATO

LED XOB 9.8 mm
 FWHM / FWTM 14.0° / 34.5 + 34.0°
 Efficiency 74 %
 Peak intensity 6.4 cd/lm
 LEDs/each optic 1
 Light colour White
 Required components:
 F15255_HEKLA-SOCKET-C

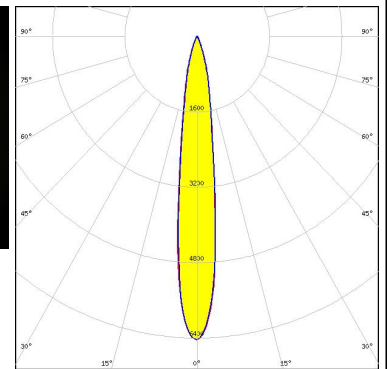
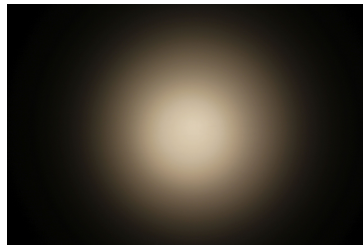

XICATO

LED XTM - 19mm LES
 FWHM / FWTM 23.0° / 60.0°
 Efficiency 66 %
 Peak intensity 2.2 cd/lm
 LEDs/each optic 1
 Light colour White
 Required components:
 C16058_XTM-ADAPTER-50-C

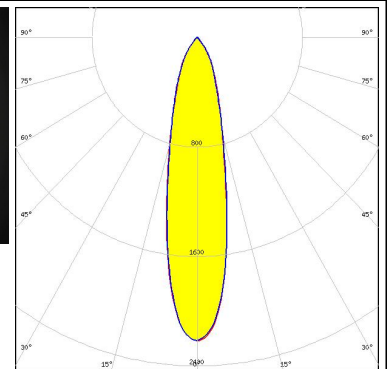
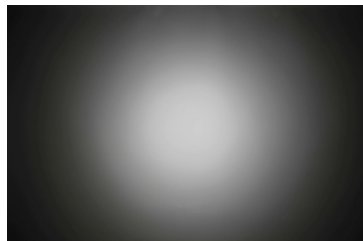

OPTICAL RESULTS (SIMULATED):

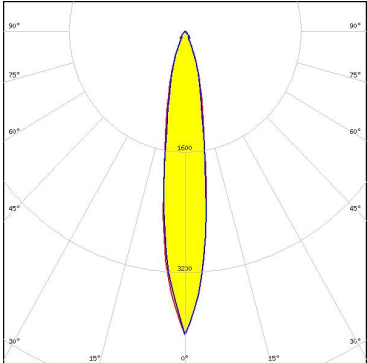
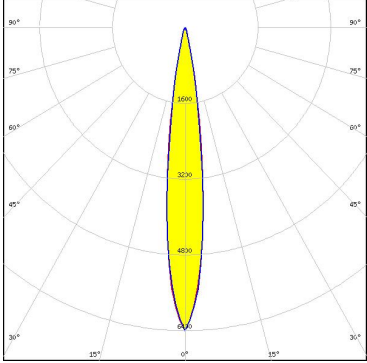
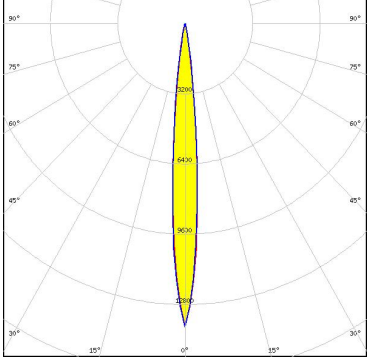
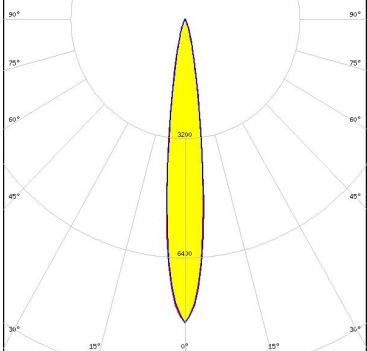
<p>bridgelux</p> <p>LED VERO13 FWHM / FWTM 16.0° / 42.0° Efficiency 70 % Peak intensity 4 cd/lm LEDs/each optic 1 Light colour White Required components: C16142_HEKLA-SOCKET-K</p>	
<p>CITIZEN</p> <p>LED CLL02x/CLU02x (LES10) FWHM / FWTM 14.0° / 26.0° Efficiency 50 % Peak intensity 6.4 cd/lm LEDs/each optic 1 Light colour White Required components: F15859_HEKLA-SOCKET-I C16752_CARMEN-70-SHD</p>	
<p>CITIZEN</p> <p>LED CLU700/701/702/703 FWHM / FWTM 10.0° / 19.0° Efficiency 54 % Peak intensity 13.8 cd/lm LEDs/each optic 1 Light colour White Required components: F15255_HEKLA-SOCKET-C C16752_CARMEN-70-SHD</p>	
<p>CITIZEN</p> <p>LED CLU712/713 FWHM / FWTM 14.0° / 30.0° Efficiency 75 % Peak intensity 8.1 cd/lm LEDs/each optic 1 Light colour White Required components: F15859_HEKLA-SOCKET-I</p>	

OPTICAL RESULTS (SIMULATED):

CITIZEN

LED CLU712/713
 FWHM / FWTM 12.0° / 24.0°
 Efficiency 51 %
 Peak intensity 7.6 cd/lm
 LEDs/each optic 1
 Light colour White
 Required components:
 F15859_HEKLA-SOCKET-I
 C16752_CARMEN-70-SHD

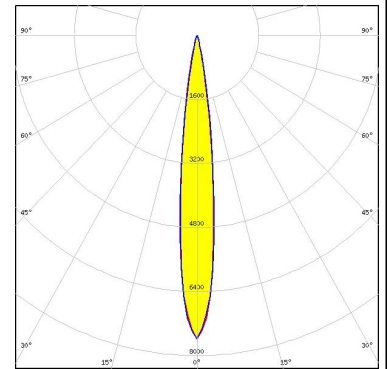

CITIZEN

LED CLU7A2/7A3
 FWHM / FWTM 8.0° / 16.0°
 Efficiency 55 %
 Peak intensity 18.2 cd/lm
 LEDs/each optic 1
 Light colour White
 Required components:
 F15255_HEKLA-SOCKET-C
 C16752_CARMEN-70-SHD

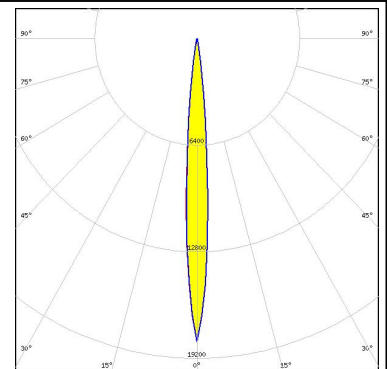

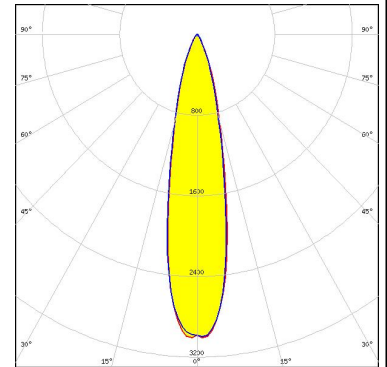

LED CMA1840
 FWHM / FWTM 22.0° / 47.0°
 Efficiency 66 %
 Peak intensity 3 cd/lm
 LEDs/each optic 1
 Light colour White
 Required components:
 Bender Wirth: 637a Hekla

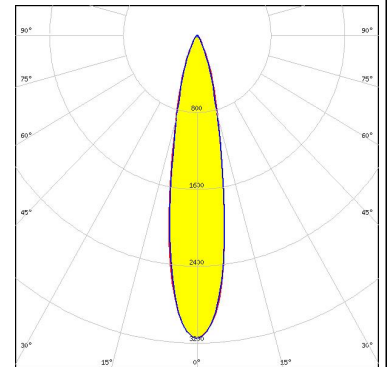

LED CMU15xx
 FWHM / FWTM 21.0° / 46.0°
 Efficiency 65 %
 Peak intensity 3.2 cd/lm
 LEDs/each optic 1
 Light colour White
 Required components:
 F17438_HEKLA-G2-I

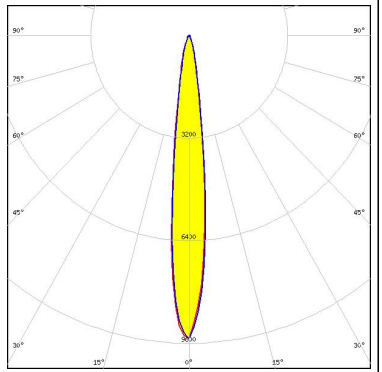
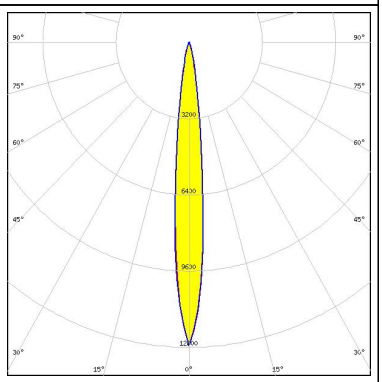

OPTICAL RESULTS (SIMULATED):

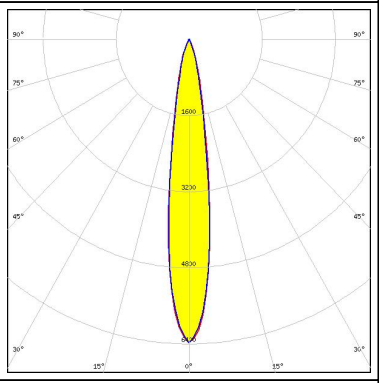
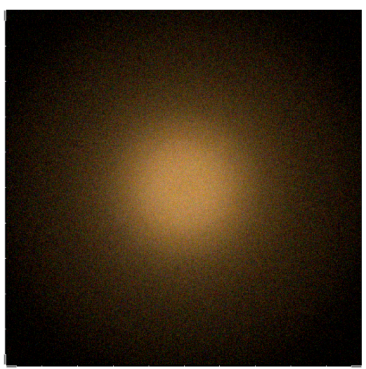
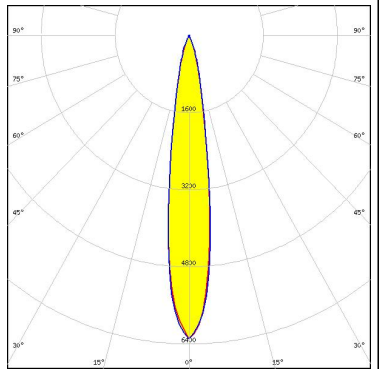
<p>CREE LED</p> <p>LED: CXA/B 15xx FWHM / FWTM: 12.9° / 28.4° Efficiency: 0 % Peak intensity: 9.5 cd/lm LEDs/each optic: 1 Light colour: White Required components: F15256_HEKLA-SOCKET-D</p>		
<p>NICHIA</p> <p>LED: COB T-Type FWHM / FWTM: 11.0° / 24.0° Efficiency: 78 % Peak intensity: 12.7 cd/lm LEDs/each optic: 1 Light colour: White Required components: F15848_HEKLA-SOCKET-G</p>		
<p>SAMSUNG</p> <p>LED: LC003D / LC006D / LC009D / LC013D FWHM / FWTM: 16.0° / 34.0° Efficiency: 73 % Peak intensity: 6.4 cd/lm LEDs/each optic: 1 Light colour: White Required components: F17435_HEKLA-G2-C</p>		
<p>SAMSUNG</p> <p>LED: LC003D / LC006D / LC009D / LC013D FWHM / FWTM: 16.0° / 34.0° Efficiency: 73 % Peak intensity: 6.3 cd/lm LEDs/each optic: 1 Light colour: White Required components: F17435_HEKLA-G2-C</p>		

OPTICAL RESULTS (SIMULATED):

SAMSUNG

LED	LC010C
FWHM / FWTM	11.0° / 24.0°
Efficiency	78 %
Peak intensity	13 cd/lm
LEDs/each optic	1
Light colour	White
Required components:	
F17435_HEKLA-G2-C	

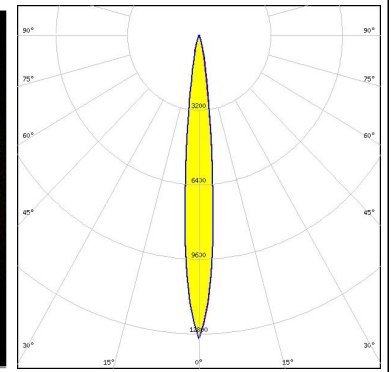
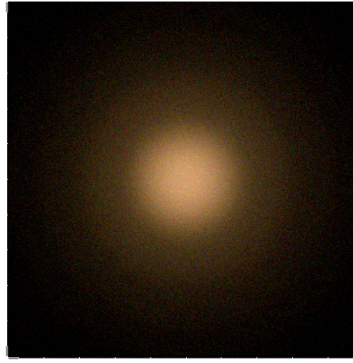

GENERAL INFORMATION:

NOTE: The typical beam angle will be changed by different color, chip size and chip position tolerance. The typical total beam angle is the full angle measured where the luminous intensity is half of the peak value.

Due to use of high power COB's with this product, special attention to proper thermal design is highly recommended. LEDiL has no liability for direct, indirect or consecutive damages arising from the LEDiL products being used outside of the recommended temperature range.

MATERIALS:

As part of our continuous research and improvement processes, and to ensure the best possible quality and availability of our products, LEDiL reserves the right to change material grades without notice.

PRODUCT DATA USER AGREEMENT AND DISCLAIMER:

The measured data in the provided downloadable LEDiL Product Datasheets and Mechanical 2D-Drawings is rounded and provided as reference for planning. LEDiL Oy's optical specifications have been verified by conducting performance testing of the products in accordance with the company's quality system. The reported data are averaged results of multiple measurements with typical variation. LEDiL Oy reserves the right to without prior notification make changes and improvements to its products.

LEDiL Oy assumes neither warranty, nor guarantee nor any other liability of any kind for the contents and correctness of the provided data. The provided data has been generated with highest diligence but the provided data may in reality not represent the complete possible variation range of all intrinsic parameters. Therefore, in certain cases a deviation from the provided data could occur.

LEDiL Oy reserves the right to undertake technical changes of its products without further notification which could lead to changes in the provided data. LEDiL Oy assumes no liability of any kind for the possible deviation from any provided data or any other damage resulting from the usage of the provided data.

The user agrees to this disclaimer and user agreement with the download or usage of the provided files.

LEDiL Oy

Joensuunkatu 13
FI-24240 SALO
Finland

LEDiL Inc.

228 West Page Street
Suite D
Sycamore IL 60178
USA

Ledil Optics Technology (Shenzhen) Co., Ltd.

405 , Block B
Casic Motor Building
Shenzhen 518057
P.R.CHINA

Local sales and technical support

[www.ledil.com/
where_to_buy](http://www.ledil.com/where_to_buy)

Shipping locations

Salo, Finland
Hong Kong, China

Distribution Partners

[www.ledil.com/
where_to_buy](http://www.ledil.com/where_to_buy)