

# **SPECIFICATION**

## **PATENTED**

Part No. : **TG.30.8111W**

Product Name : Apex White Straight TG.30  
Ultra-Wideband 4G LTE Antenna

Feature : LTE / GSM / CDMA /DCS /PCS / WCDMA /  
UMTS / HSDPA / GPRS / EDGE /GPS /Wi-Fi  
698~960MHz, 1575.42MHz, 1710~2700MHz  
Typical 70%+ Efficiency and 3dBi+ Peak Gain  
Dipole Swivel Terminal Antenna  
White Version  
Straight SMA(M) Connector  
**RoHS Compliant**



## 1. Introduction

The Apex White Straight TG.30 Dipole LTE Antenna is primarily designed for use with 4G LTE modules and devices that require the highest possible efficiency and peak gain to deliver best in class throughput on all major cellular (4G/3G/2G) bands worldwide for access points, terminals and routers. The antenna is a ground plane independent antenna with a SMA (M) connector and swivel mechanism that allows the antenna part to be rotated around the connector. The Apex exhibits high efficiency across the ultra wide band and is backward compatible with 2G and 3G cellular applications such as GSM, LTE, UMTS, WiFi and even has GPS included for Assisted GPS and/or E911 applications. With very high efficiency on every cellular band globally it is an ideal solution for any device requiring high, reliable performance. It is also guaranteed to meet any type approval or carrier certification requirements from a RF standpoint. It is an omnidirectional antenna and the radiation patterns display this and are stable across all bands.

It has a quality robust housing for use with wireless terminals. The swivel mechanism allows the antenna part itself to be orientated in different directions and can help avoid touching off other antennas or objects close by as well as helping with isolation by orientating the antenna in different directions in MIMO systems or when other TG.30 antennas are present on the same device.

This patented antenna is also available in Black; hinged and right angled versions.

## 2. Specification

<b>ELECTRICAL</b>							
Frequency (MHz)	700~800	824~960	1575.42	1710 ~ 1880	1850 ~ 1990	1710 ~ 2170	2400~2700
<b>Peak Gain (dBi)</b>							
Free Space	2.0	1.2	0.3	2.4	3.0	3.0	4.2
On 30*30cm GP	3.0	1.5	2.9	3.7	3.6	3.7	6.5
<b>Average Gain</b>							
Free Space	-0.7	-1.1	-1.7	-0.2	-0.5	-0.2	-0.7
On 30*30cm GP	-0.3	-1.0	-1.2	-0.4	-0.6	-0.4	-0.4
<b>Efficiency</b>							
Free Space	86%	78%	67%	82%	89%	55%	60%
On 30*30cm GP	90%	68%	75%	82%	86%	70%	72%
Impedance	50Ω						
Polarization	Linear						
Radiation Pattern	Omnidirectional						
Input Power	10W						
<b>MECHANICAL</b>							
Casing	UV Resistant, PC/ABS						
Connector	SMA Male						
<b>ENVIRONMENTAL</b>							
Temperature Range	-40°C to 85°C						
Humidity	Non-condensing 65°C 95% RH						

LTE BANDS			
Band Number	LTE / LTE-Advanced / WCDMA / HSPA / HSPA+ / TD-SCDMA		
	Uplink	Downlink	Covered
1	UL: 1920 to 1980	DL: 2110 to 2170	✓
2	UL: 1850 to 1910	DL: 1930 to 1990	✓
3	UL: 1710 to 1785	DL: 1805 to 1880	✓
4	UL: 1710 to 1755	DL: 2110 to 2155	✓
5	UL: 824 to 849	DL: 869 to 894	✓
7	UL: 2500 to 2570	DL: 2620 to 2690	✓
8	UL: 880 to 915	DL: 925 to 960	✓
9	UL: 1749.9 to 1784.9	DL: 1844.9 to 1879.9	✓
11	UL: 1427.9 to 1447.9	DL: 1475.9 to 1495.9	✗
12	UL: 699 to 716	DL: 729 to 746	✓
13	UL: 777 to 787	DL: 746 to 756	✓
14	UL: 788 to 798	DL: 758 to 768	✓
17	UL: 704 to 716	DL: 734 to 746 (LTE only)	✓
18	UL: 815 to 830	DL: 860 to 875 (LET only)	✓
19	UL: 830 to 845	DL: 875 to 890	✓
20	UL: 832 to 862	DL: 791 to 821	✓
21	UL: 1447.9 to 1462.9	DL: 1495.9 to 1510.9	✗
22	UL: 3410 to 3490	DL: 3510 to 3590	✗
23	UL: 2000 to 2020	DL: 2180 to 2200 (LTE only)	✓
24	UL: 1625.5 to 1660.5	DL: 1525 to 1559 (LTE only)	✓
25	UL: 1850 to 1915	DL: 1930 to 1995	✓
26	UL: 814 to 849	DL: 859 to 894	✓
27	UL: 807 to 824	DL: 852 to 869 (LTE only)	✓
28	UL: 703 to 748	DL: 758 to 803 (LTE only)	✓
29	UL: -	DL: 717 to 728 (LTE only)	✓
30	UL: 2305 to 2315	DL: 2350 to 2360 (LTE only)	✓
31	UL: 452.5 to 457.5	DL: 462.5 to 467.5 (LTE only)	✗
32	UL: -	DL: 1452 - 1496	✗
35		1850 to 1910	✓
38		2570 to 2620	✓
39		1880 to 1920	✓
40		2300 to 2400	✓
41		2496 to 2690	✓
42		3400 to 3600	✗
43		3600 to 3800	✗

\*Covered bands represent an efficiency greater than 20%

## 3. Antenna Characteristics

### 3.1 Return Loss



### 3.2 Peak Gain

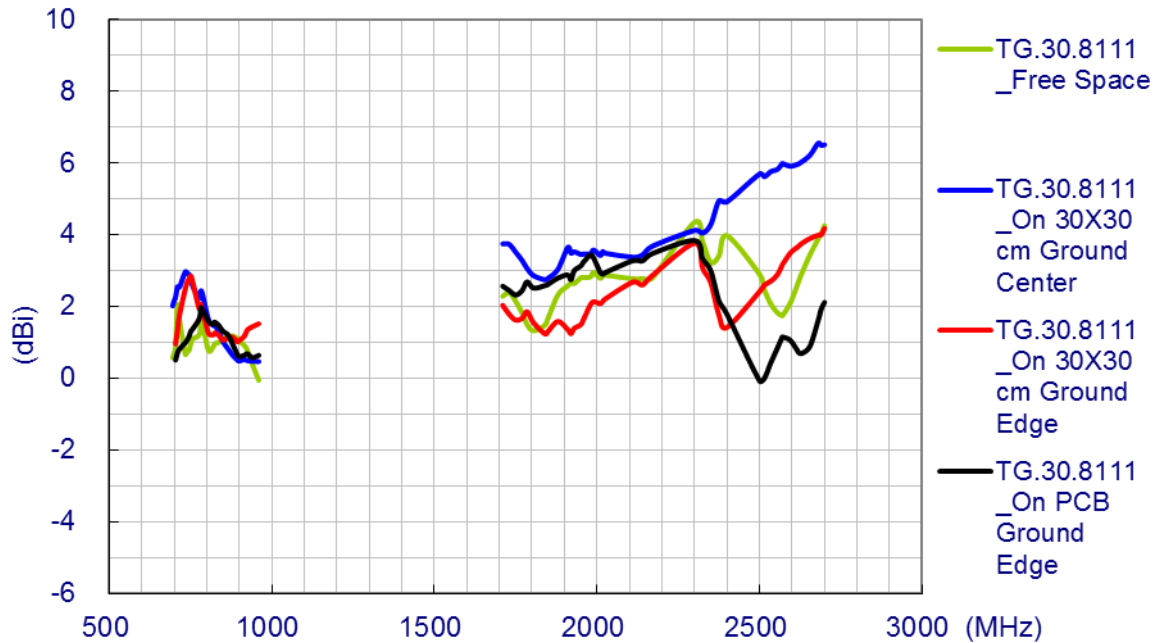

### 3.3 Average Gain

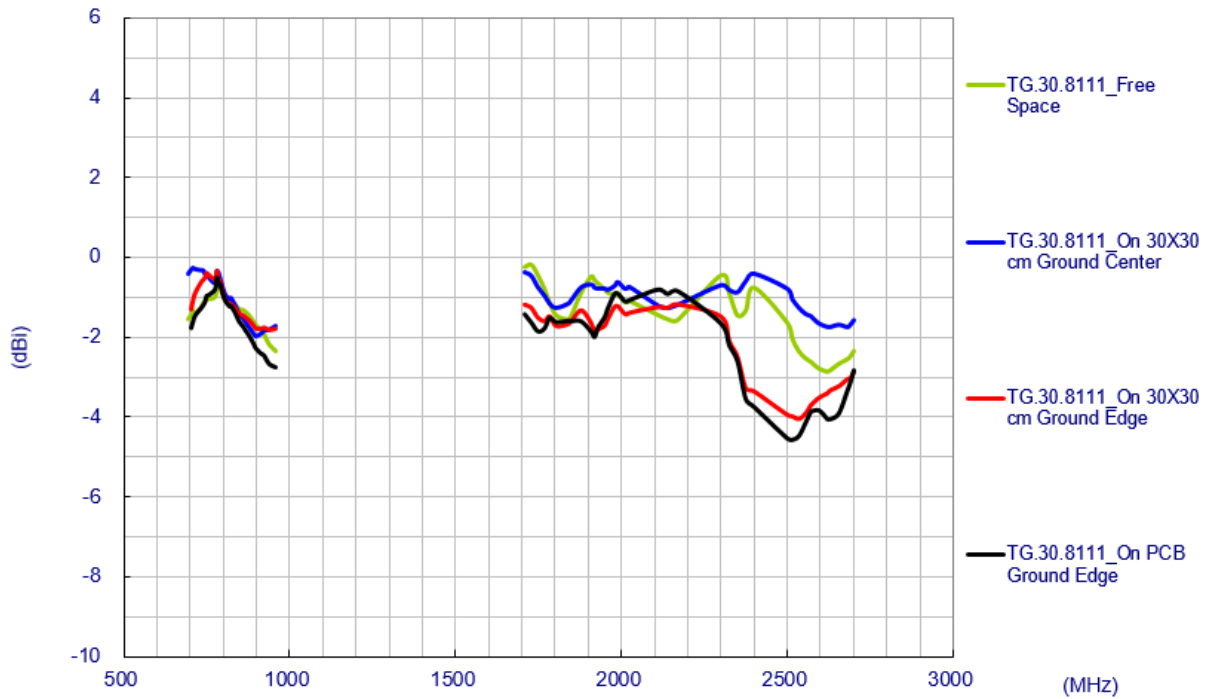

### 3.4 Efficiency

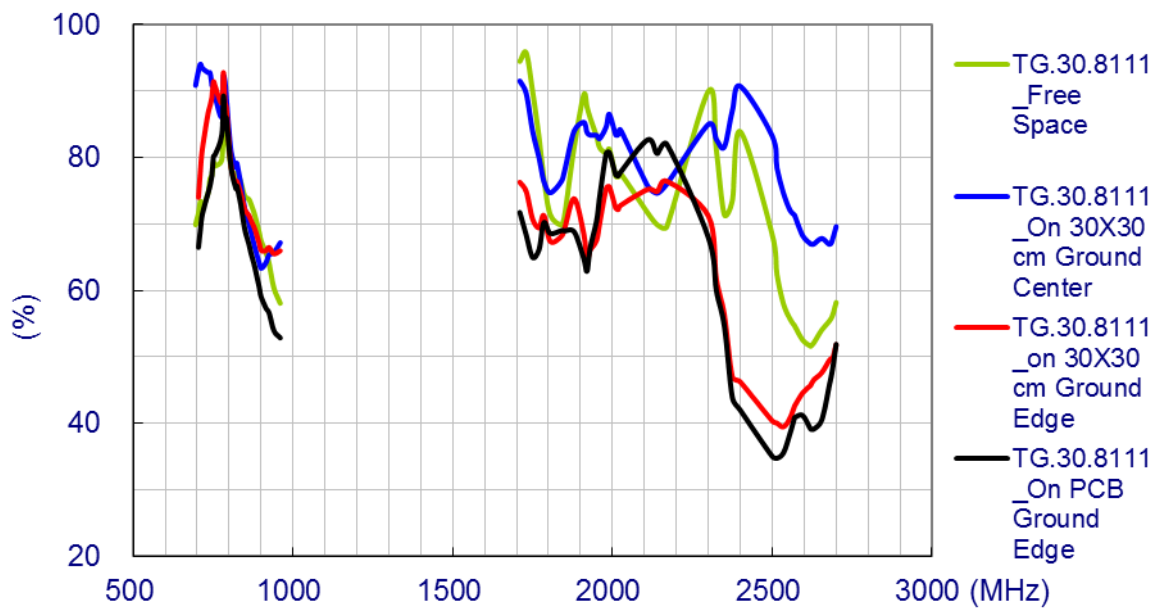

## 4. Antenna Radiation Patterns

### 4.1 Antenna setup (Free Space)

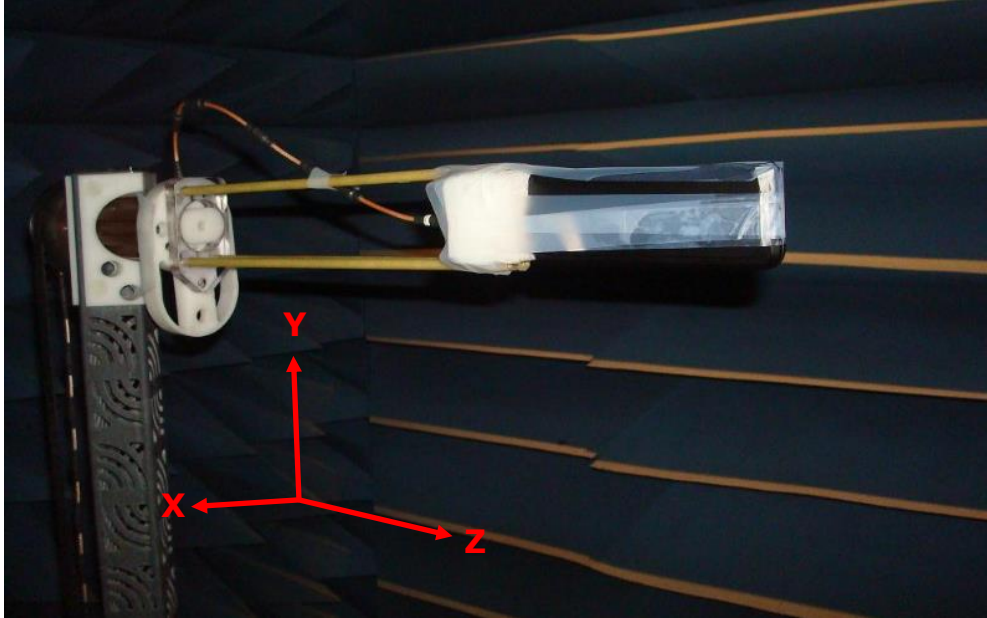

## 4.2 Radiation Patterns (Free Space)

XY Plane

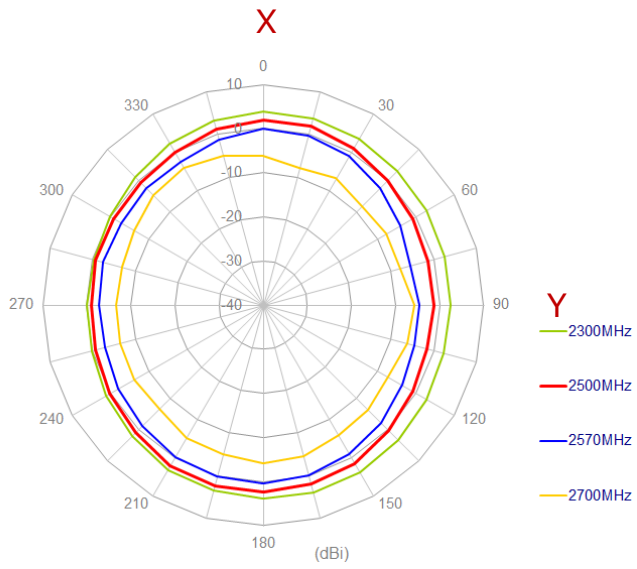
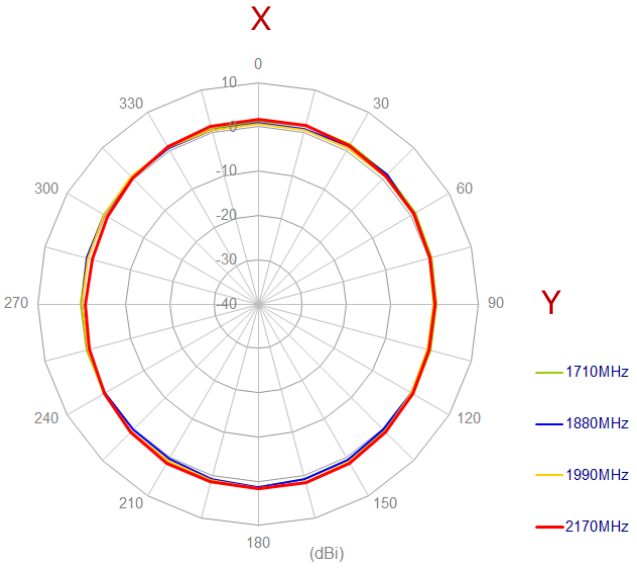
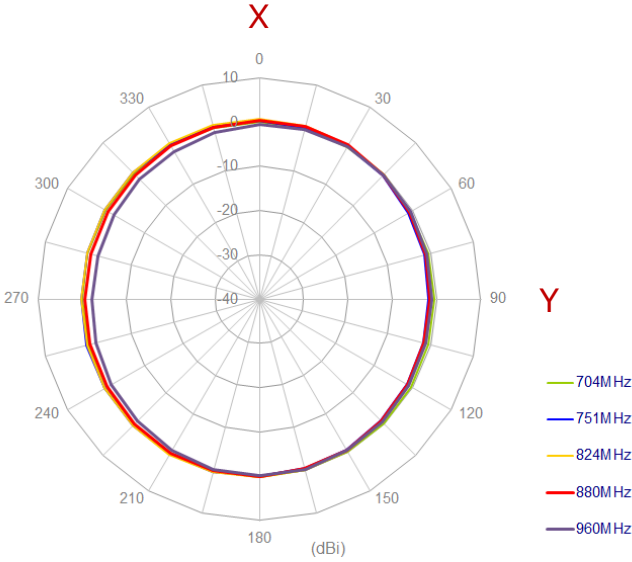



XZ Plane

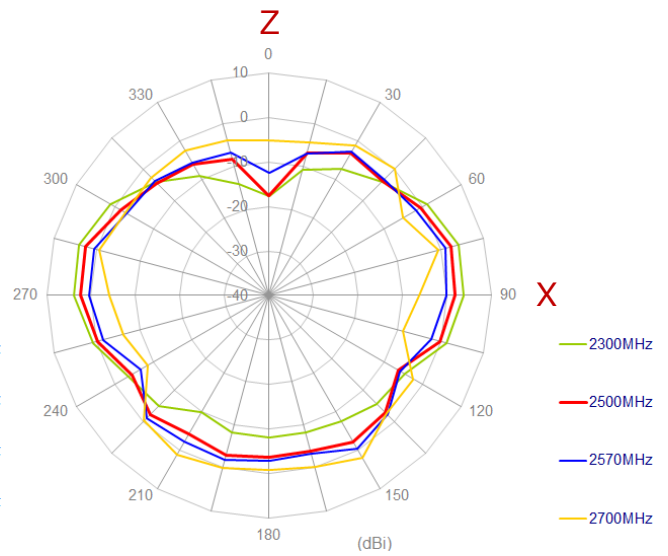
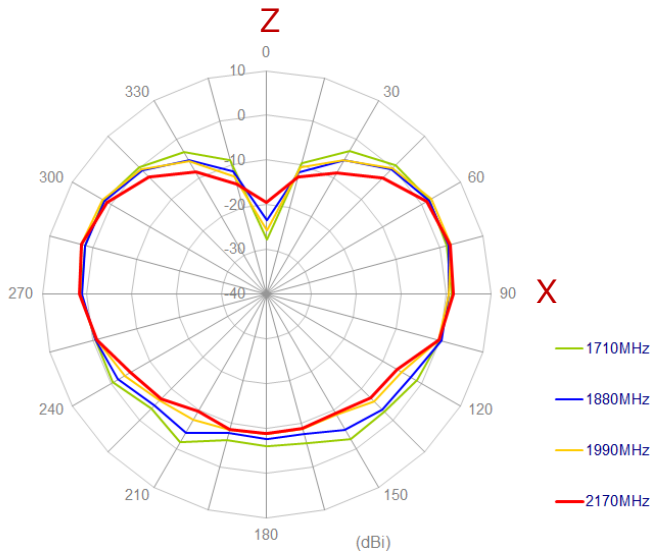
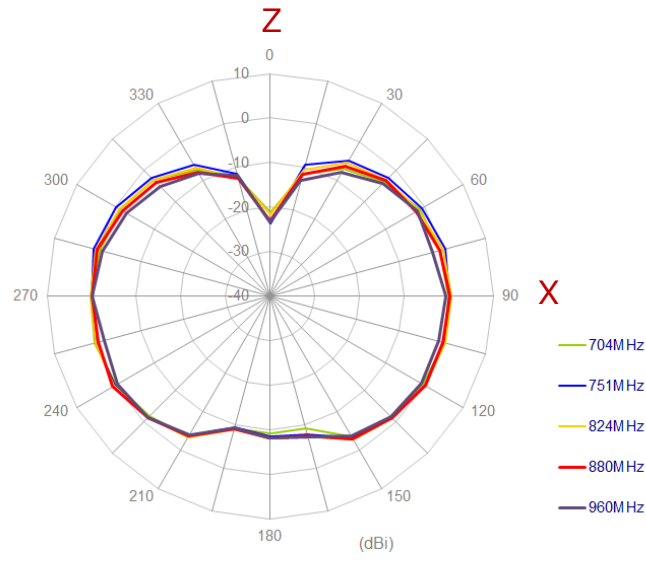

### 4.3 Antenna setup (On 300\*300mm ground center)

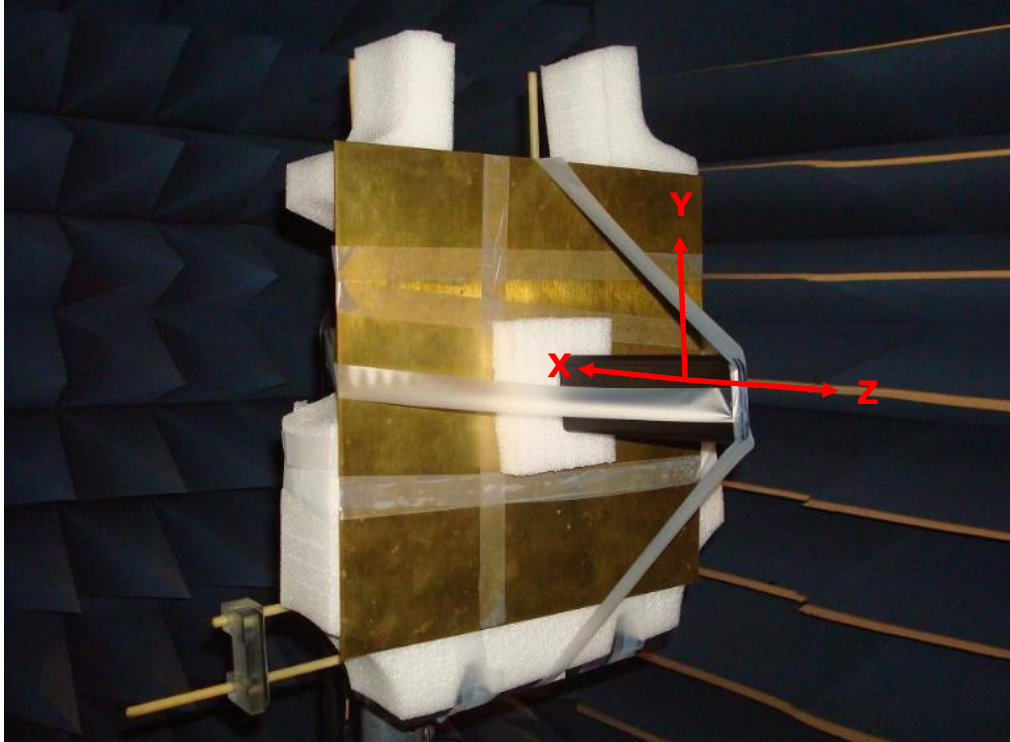

## 4.4 Radiation Patterns (On 300\*300mm ground center)

### XY Plane

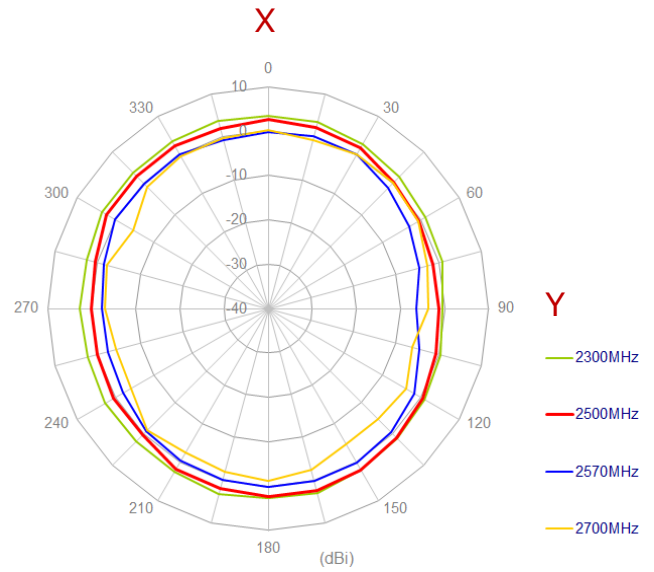
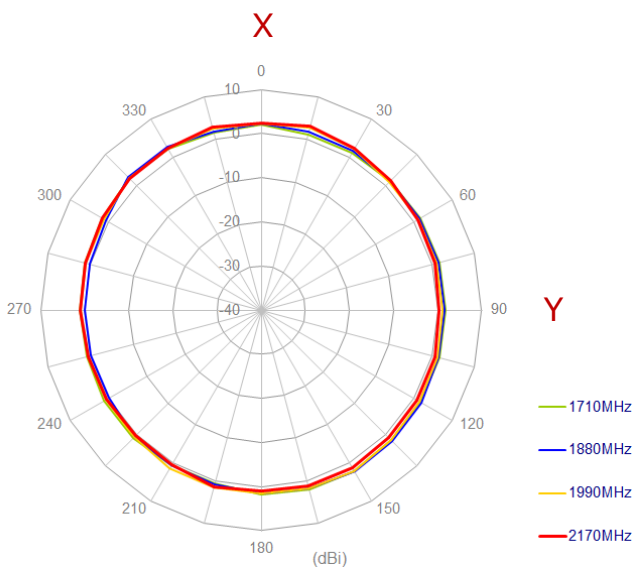
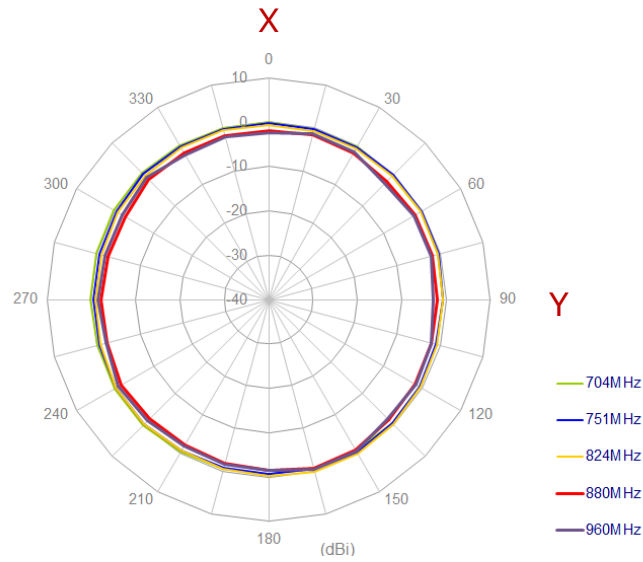

**XZ Plane**

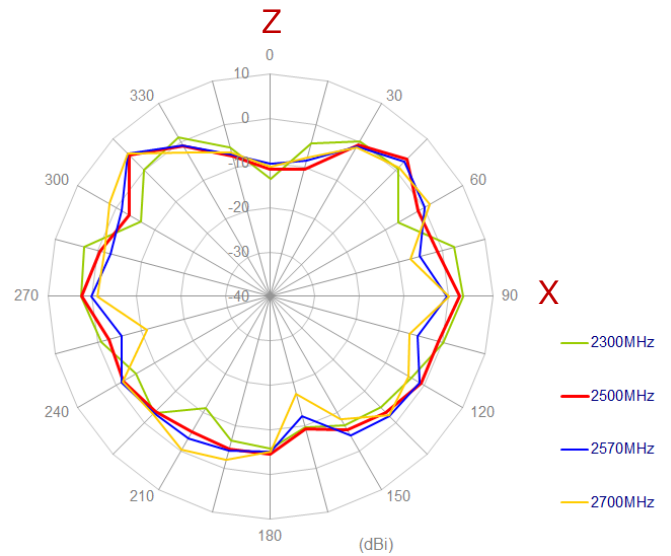
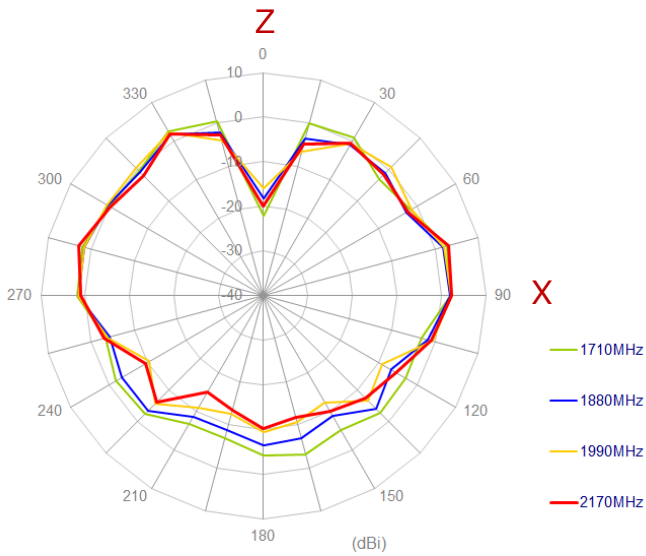
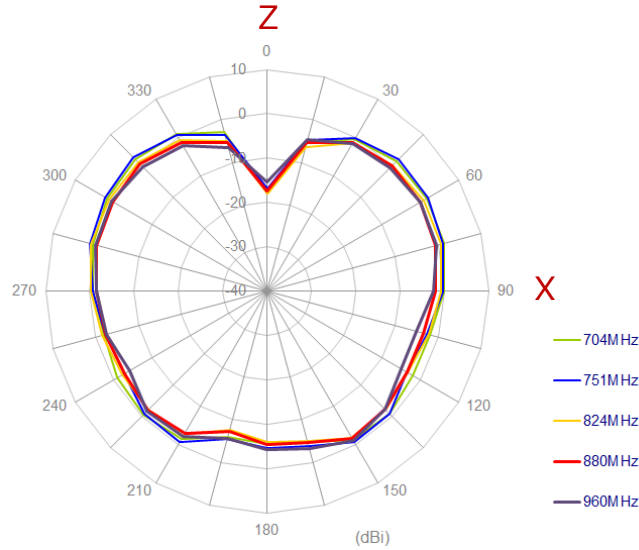

**4.5 Antenna setup (On 300\*300mm ground edge)**

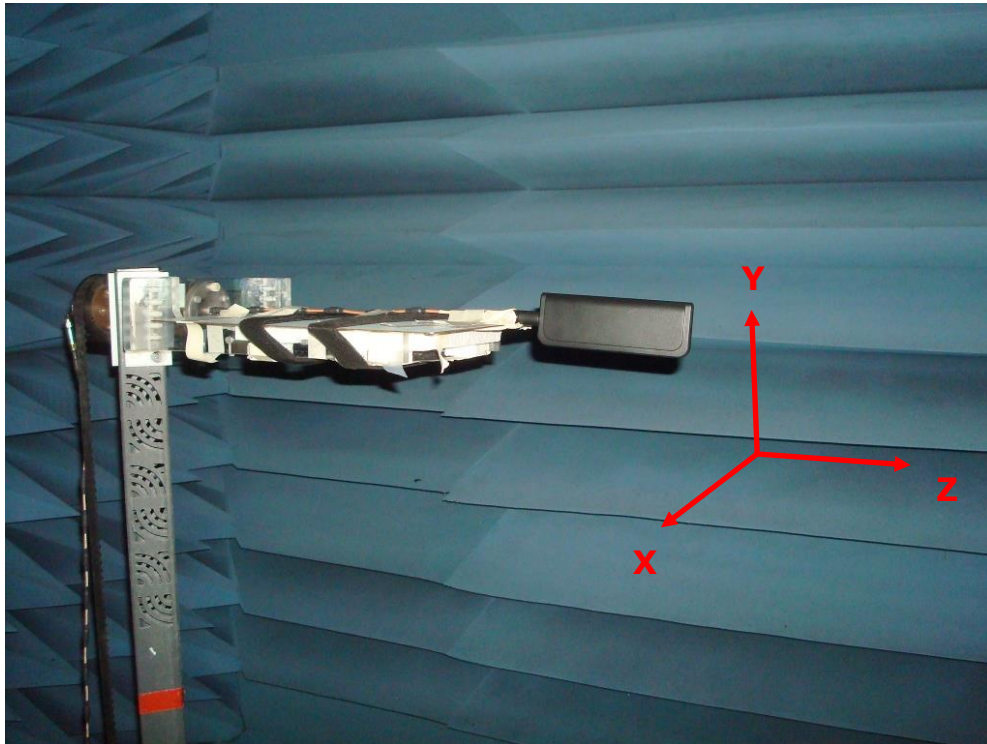

## 4.6 Radiation Patterns (On 300\*300mm ground edge)

### XY Plane

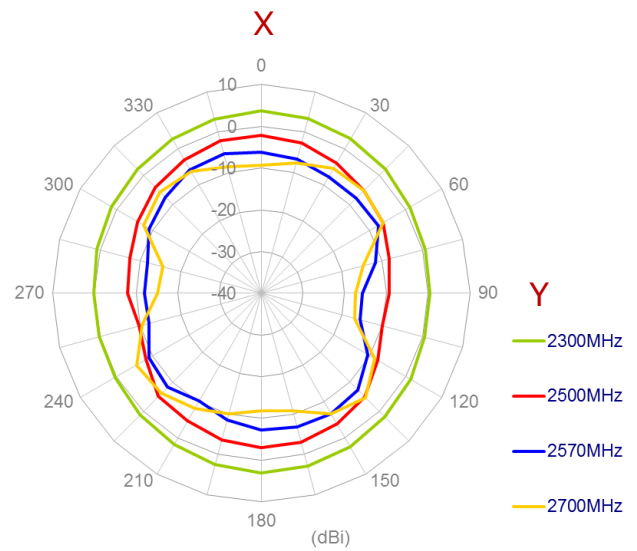
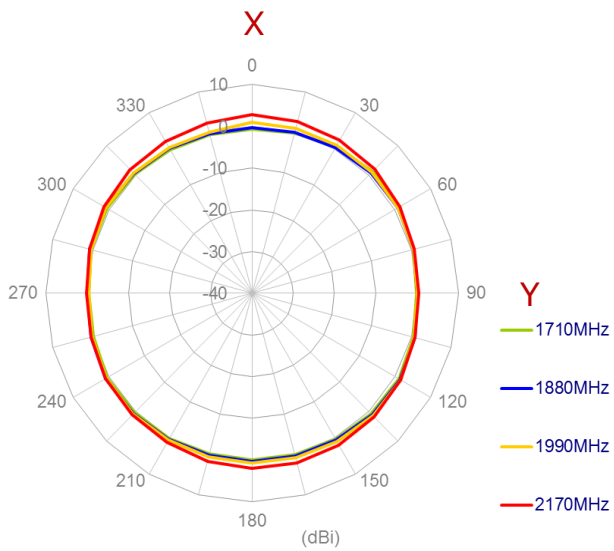
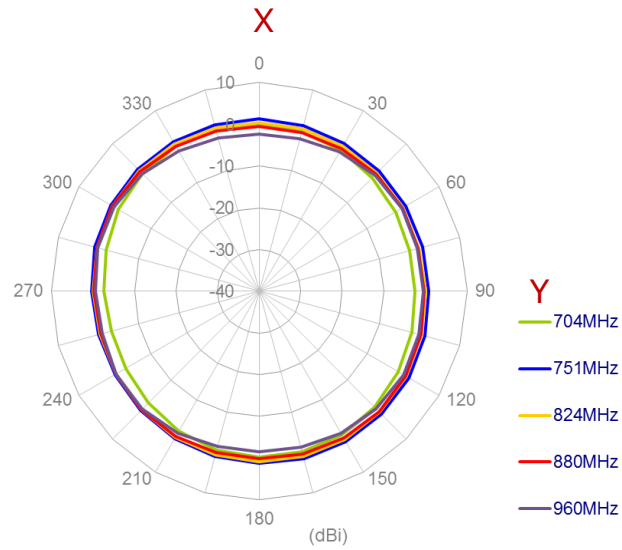

**XZ Plane**

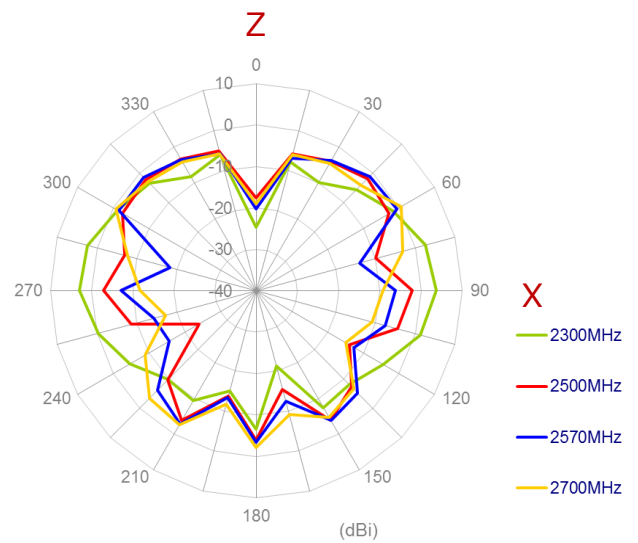
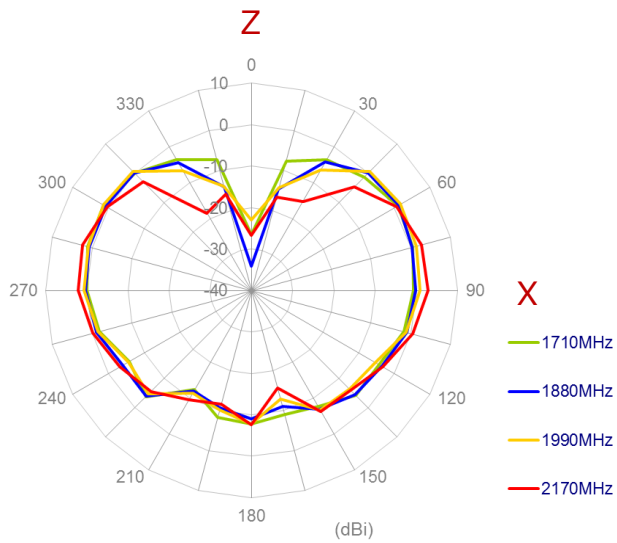
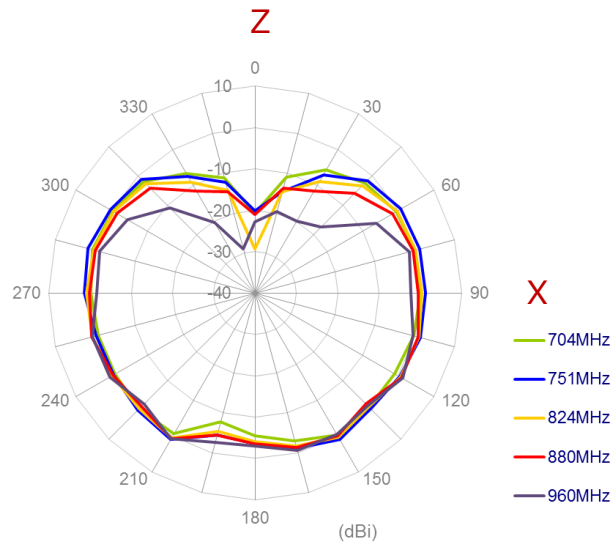



#### 4.7 Antenna setup (On ground edge)

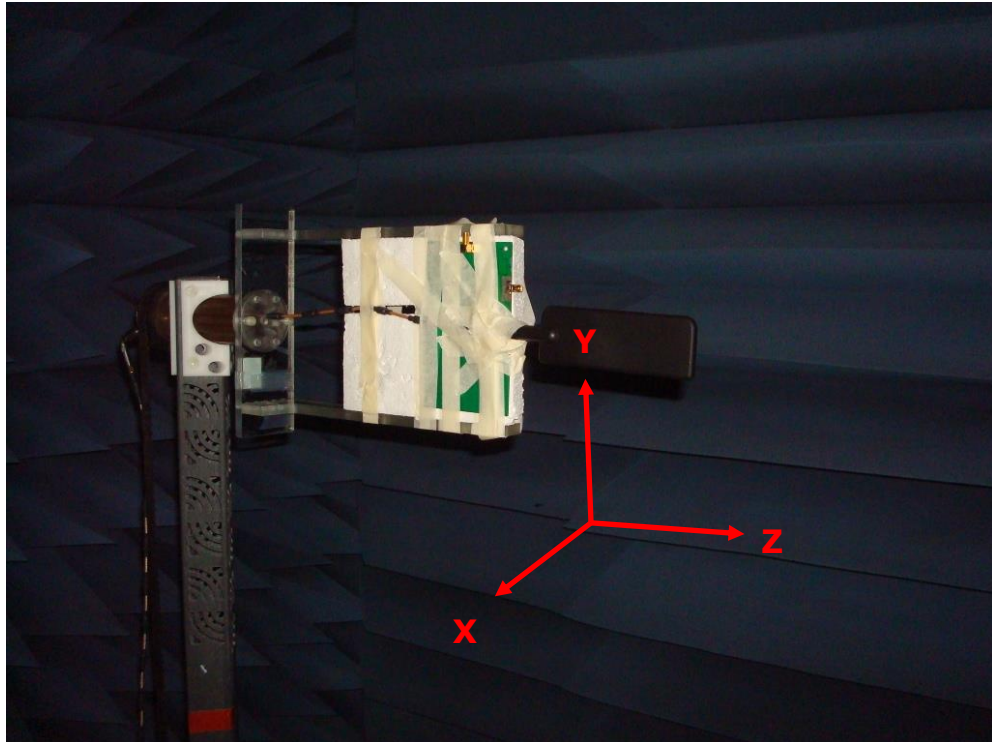



## 4.8 Radiation Patterns (On ground edge)

### XY Plane

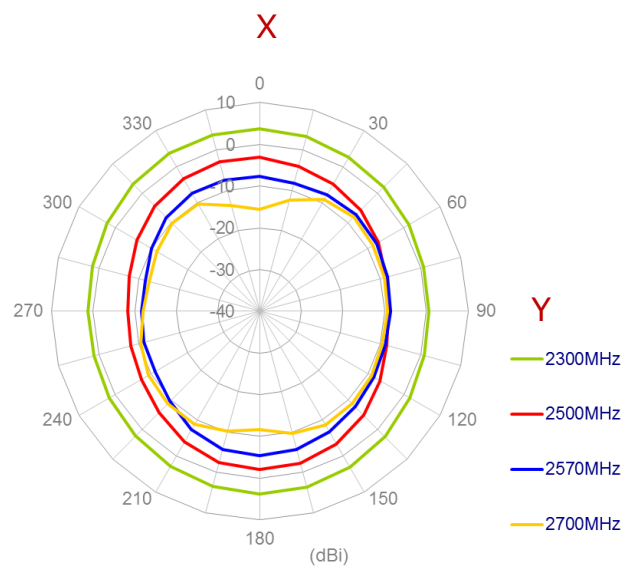
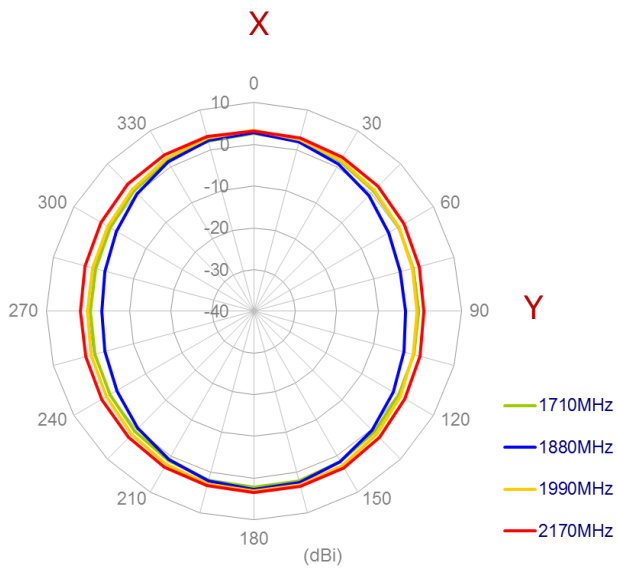
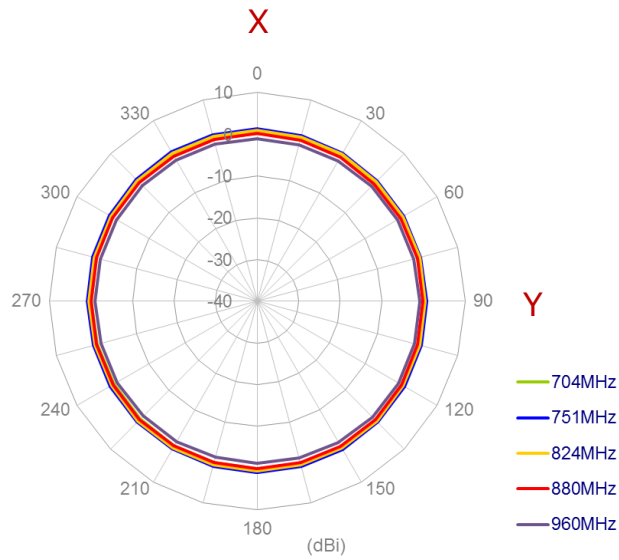

**XZ Plane**

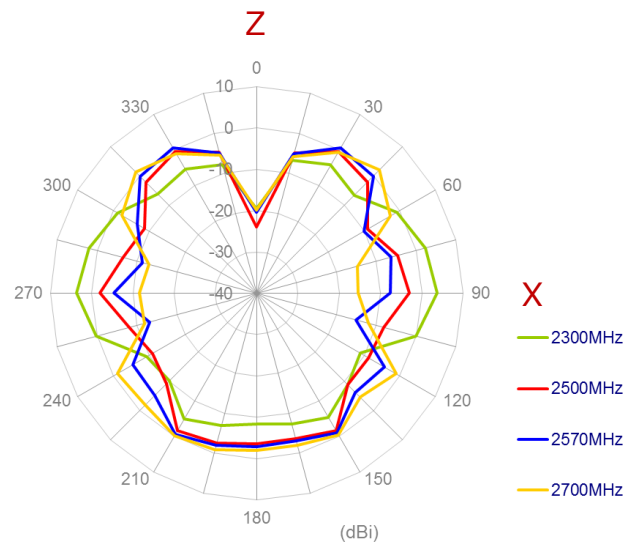
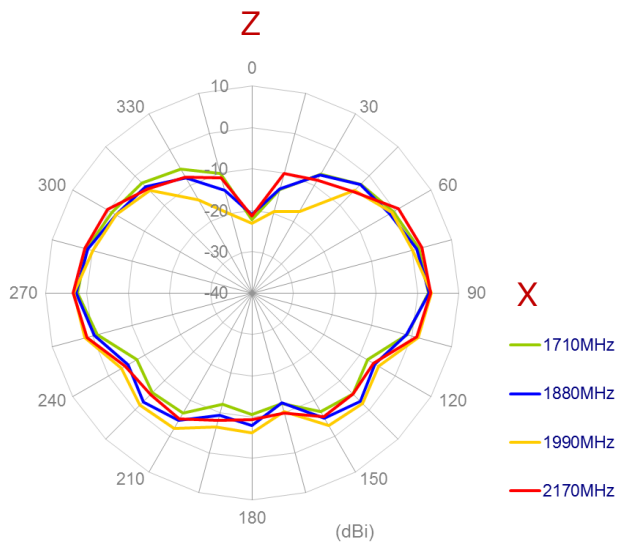
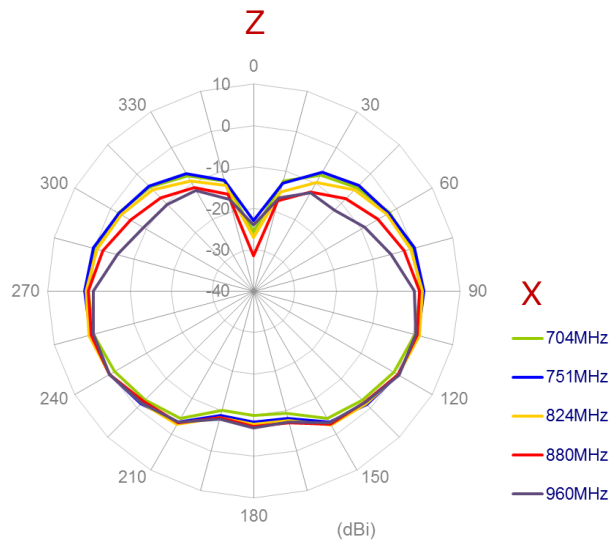

## 5 Drawing (Unit: mm)

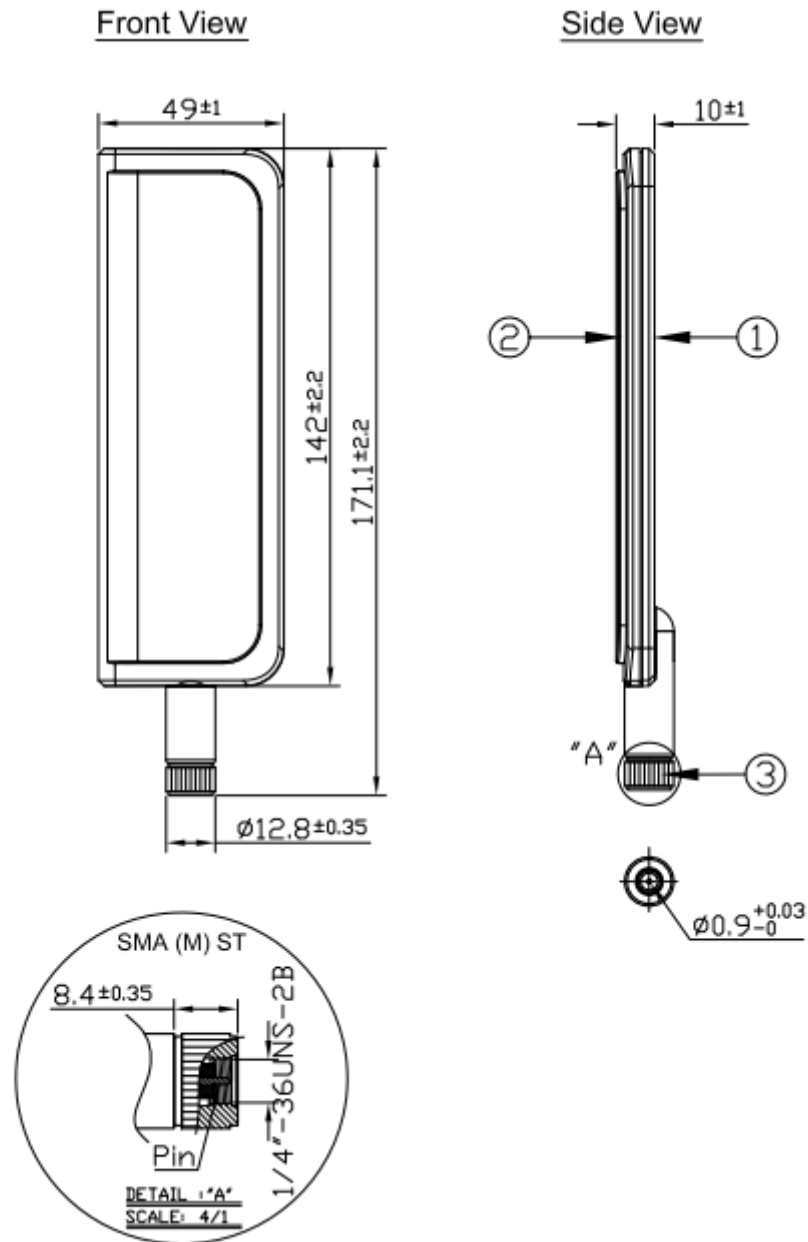

## 6 Packaging (Unit: mm)

1pc TG.30.8111W per Small PE Bag  
Small PE Bag Dimensions - 230\*130mm  
Weight - 127g



50pcs TG.30.8111W per Large PE Bag  
Large PE Bag Dimensions - 395\*338mm  
Weight - 6.35Kg

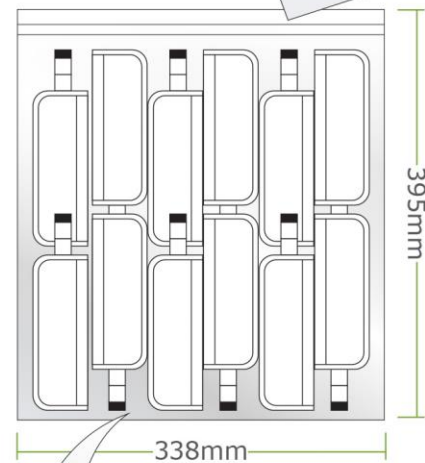

200pcs TG.30.8111W per carton  
Carton Dimensions - 315\*380\*290mm  
Weight - 6.5Kg

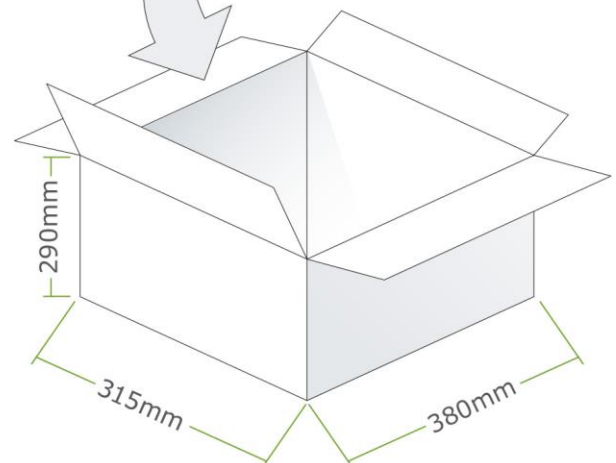

Taoglas makes no warranties based on the accuracy or completeness of the contents of this document and reserves the right to make changes to specifications and product descriptions at any time without notice. Taoglas reserves all rights to this document and the information contained herein.

Reproduction, use or disclosure to third parties without express permission is strictly prohibited.