

SUMMARY



Image is for illustrative purpose only

Wires

Low voltage 6

Series 2S
Termination type Male solder
IP rating 50
AWG wire size 28.00 - 20.00
Cable Ø 5.30 - 6.20 mm
Status active
Matching parts [ERA.2S.306.CLL](#)

Download

[Request a quote](#)
[Catalog](#)

TECHNICAL DETAILS

Mechanics

Shell Style/Model FFA*: Straight plug, cable collet
Keying Hermaphroditic keying (half moon insert) with male pin 1
Housing Material Brass (chrome plated [SAE AMS 2460]) shell and collet nut, nickel plated [SAE AMS QQ N 290] brass latch sleeve and mid pieces
Weight 32.57 g

Performance

Configuration 2S.306 : 6 Low Voltage
Insulator L: PEEK (UL 94 / V-0/1.5)
Rated Current 12 Amps

Specifications

Contact Type: Solder
Contact Dia.: 1.3 mm (0.051in)
Bucket Dia.: 1 mm (0.039in)
Max. Solid Conductor: 0.5 mm² (AWG 20)
Max. Stranded Conductor: 0.5 mm² (AWG 20)
R (max): 3.6 mOhm
Vtest: 1500 V (AC), 2100 V (DC)

LEMO products and services are provided "as is". LEMO makes no warranties or representations with regard to LEMO product & services or use of them, express, implied or statutory, including for accuracy, completeness, or security. The user is fully responsible for his products and applications using LEMO components.

Others

Endurance (Shell): 5000 mating cycles
Temp (min / max): -55°C / +250°C
Humidity (max): <=95% [at 60 deg C / 140 F]
Vibration: 15 g [10 Hz - 2000 Hz]
Shock Resistance: 100 g [6 ms]
Climatical Category: 50/175/21
Shielding (min): 75 dB (10 MHz)
Shielding (min): 40 dB (1 GHz)
Salt Spray Corrosion: >144 hr

DRAWINGS

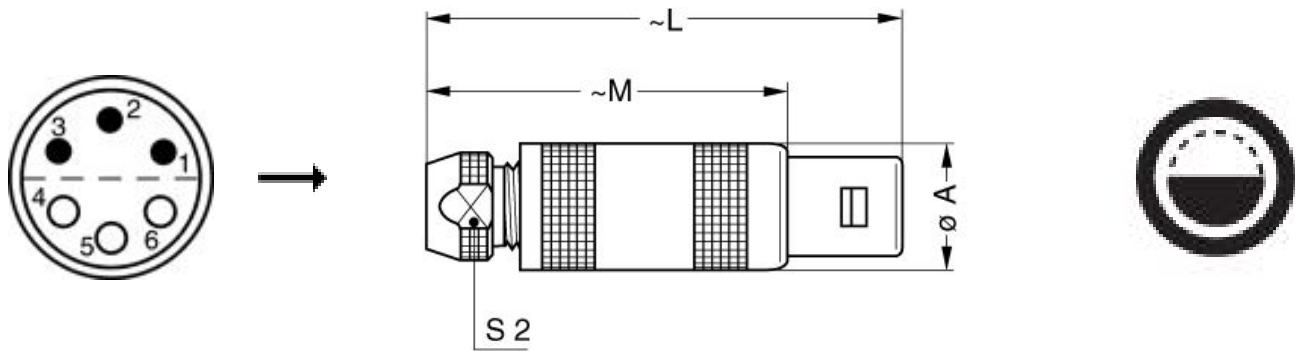

Dimensions

	A	L	M	S2
mm.	14.8	52	40	11
in.	0,58	2,05	1,57	0,43







RECOMMENDED BY LEMO

Tools

Spanner wrench: [DCD.2S.ZZZ.PA110](#)

LEMO products and services are provided "as is". LEMO makes no warranties or representations with regard to LEMO product & services or use of them, express, implied or statutory, including for accuracy, completeness, or security. The user is fully responsible for his products and applications using LEMO components.

Cables

CMN.06.T20.062PGZE		Grey	
CMN.06.T20.062PNZE			
CMN.06.T20.062QGZE	TPR (medical)	Grey	
106220	PVC	Black	
12080	PVC	Grey	
160240	PVC	Black	
260250	PVC	Grey	

LEMO products and services are provided "as is". LEMO makes no warranties or representations with regard to LEMO product & services or use of them, express, implied or statutory, including for accuracy, completeness, or security. The user is fully responsible for his products and applications using LEMO components.