

## G2-LAURA-W-P

~45° wide beam. Assembly with thinner white holder, installation tape and location pins.

### TECHNICAL SPECIFICATIONS:

|                |                |
|----------------|----------------|
| Dimensions     | 21.6 x 21.6 mm |
| Height         | 13.1 mm        |
| Fastening      | tape, pin      |
| ROHS compliant | yes ⓘ          |

### MATERIAL SPECIFICATIONS:

| Component               | Type        | Material | Colour | Finish |
|-------------------------|-------------|----------|--------|--------|
| LAURA-W                 | Single lens | PMMA     | clear  |        |
| LAURA-LT-PIN-XP-HLD-WHT | Holder      | PC       | white  |        |
| ROSE-TAPE               | Tape        | PU tape  | black  |        |

### ORDERING INFORMATION:

| Component                      |             | Qty in box | MOQ | MPQ | Box weight (kg) |
|--------------------------------|-------------|------------|-----|-----|-----------------|
| CA13634_G2-LAURA-W-P           | Single lens | 1440       | 360 | 180 | 6.1             |
| » Box size: 450 x 260 x 160 mm |             |            |     |     |                 |



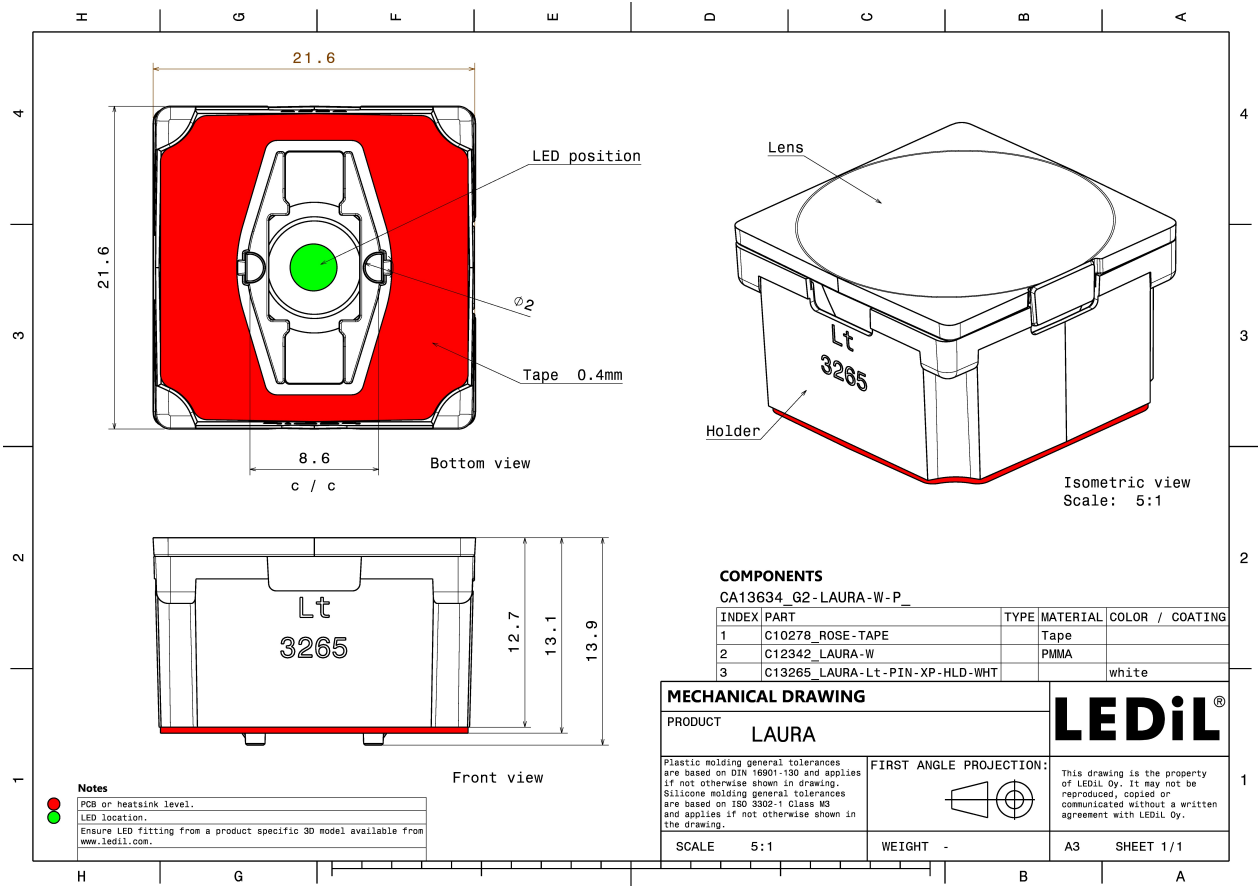

See also our general installation guide: [www.ledil.com/installation\\_guide](http://www.ledil.com/installation_guide)

#### PHOTOMETRIC DATA (MEASURED):



LED XB-D  
 FWHM / FWTM 40.0° / 69.0°  
 Efficiency 84 %  
 Peak intensity 1.6 cd/m  
 LEDs/each optic 1  
 Light colour White  
 Required components:

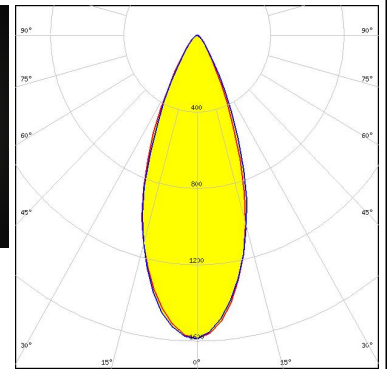
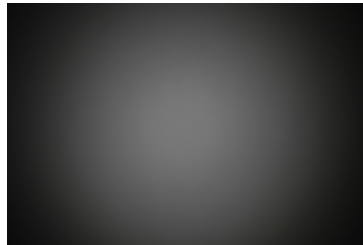

LED XB-H  
 FWHM / FWTM 47.0° / 71.0°  
 Efficiency 86 %  
 Peak intensity 1.3 cd/m  
 LEDs/each optic 1  
 Light colour White  
 Required components:

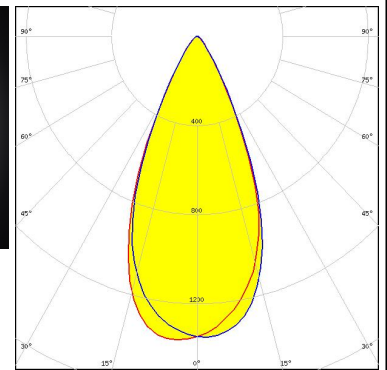
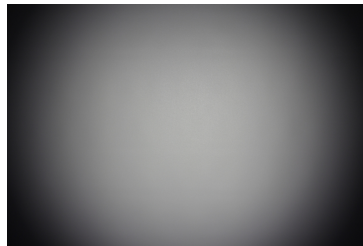

LED XP-E  
 FWHM / FWTM 45.0° / 69.0°  
 Efficiency 86 %  
 Peak intensity 1.5 cd/m  
 LEDs/each optic 1  
 Light colour White  
 Required components:

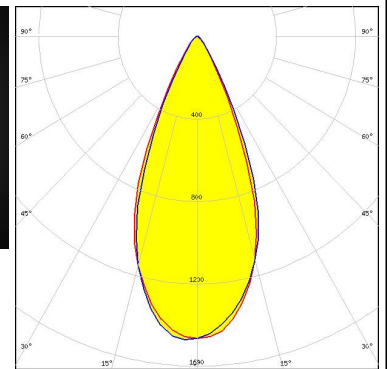
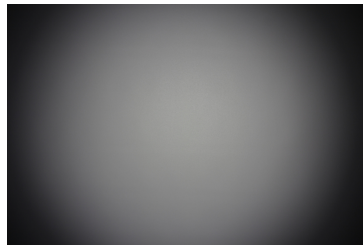

LED XP-E2  
 FWHM / FWTM 45.0° / 69.0°  
 Efficiency 87 %  
 Peak intensity 1.5 cd/m  
 LEDs/each optic 1  
 Light colour White  
 Required components:

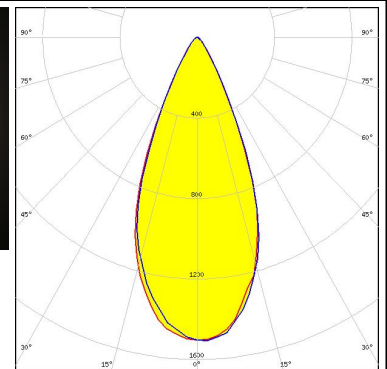
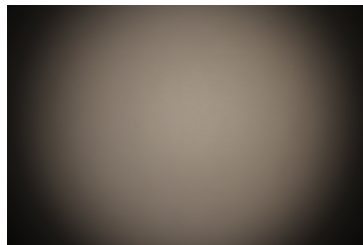

#### PHOTOMETRIC DATA (MEASURED):

#### CREE

LED XP-G  
 FWHM / FWTM 46.0° / 65.0°  
 Efficiency 91 %  
 Peak intensity 1.6 cd/lm  
 LEDs/each optic 1  
 Light colour White  
 Required components:

#### CREE

LED XP-G2  
 FWHM / FWTM 47.0° / 71.0°  
 Efficiency 87 %  
 Peak intensity 1.4 cd/lm  
 LEDs/each optic 1  
 Light colour White  
 Required components:

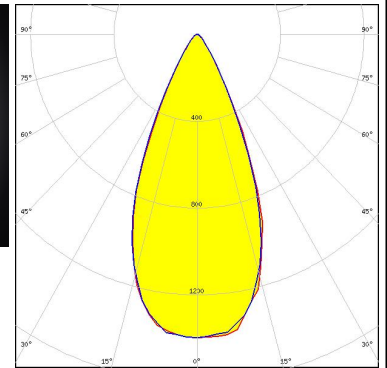
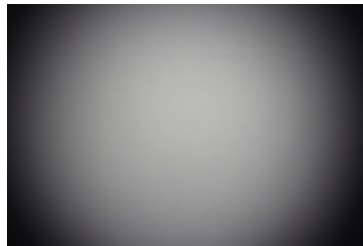

#### CREE

LED XP-L HD  
 FWHM / FWTM 49.0° / 76.0°  
 Efficiency 85 %  
 Peak intensity 1.2 cd/lm  
 LEDs/each optic 1  
 Light colour White  
 Required components:

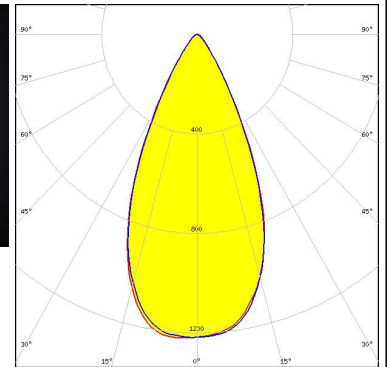
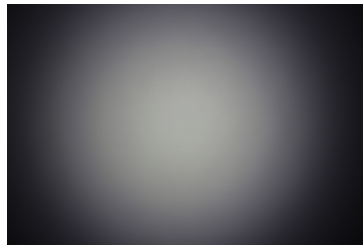

#### CREE

LED XP-L2  
 FWHM / FWTM 46.0° / 74.0°  
 Efficiency 83 %  
 Peak intensity 1.3 cd/lm  
 LEDs/each optic 1  
 Light colour White  
 Required components:

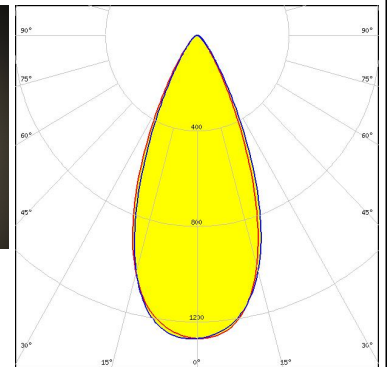
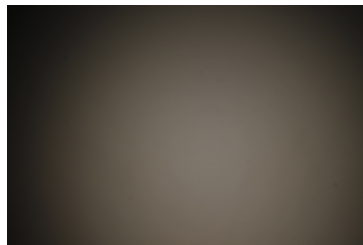



#### PHOTOMETRIC DATA (MEASURED):



LED XT-E  
 FWHM / FWTM 43.0° / 69.0°  
 Efficiency 87 %  
 Peak intensity 1.6 cd/lm  
 LEDs/each optic 1  
 Light colour White  
 Required components:

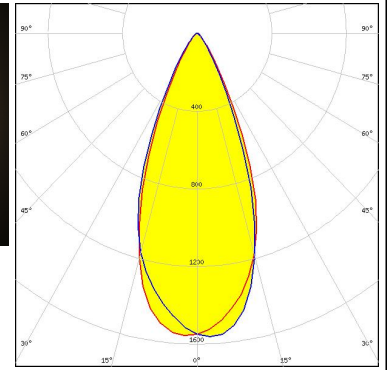
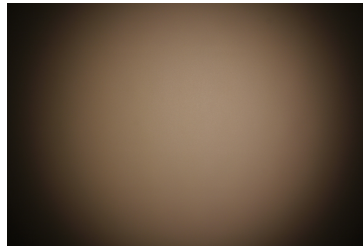

LED LUXEON 3030 2D (Round LES)  
 FWHM / FWTM 37.0° / 62.0°  
 Efficiency 86 %  
 Peak intensity 1.9 cd/lm  
 LEDs/each optic 1  
 Light colour White  
 Required components:

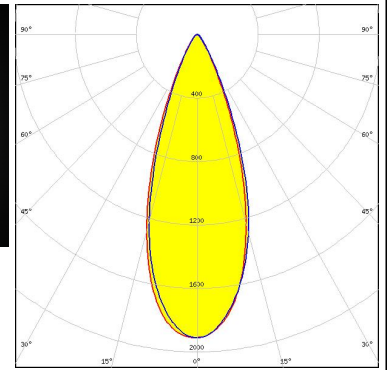
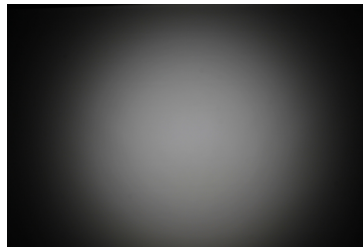

LED LUXEON TX  
 FWHM / FWTM 42.0° / 67.0°  
 Efficiency 86 %  
 Peak intensity 1.6 cd/lm  
 LEDs/each optic 1  
 Light colour White  
 Required components:

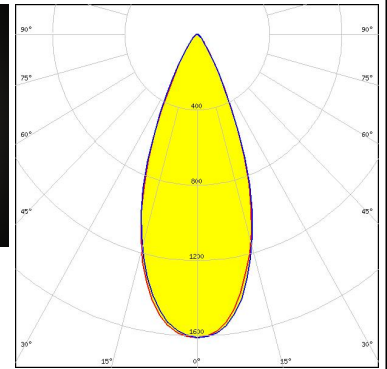
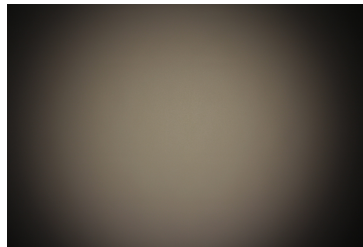

LED NCSxx19A  
 FWHM / FWTM 41.0° / 66.0°  
 Efficiency 88 %  
 Peak intensity 1.7 cd/lm  
 LEDs/each optic 1  
 Light colour White  
 Required components:

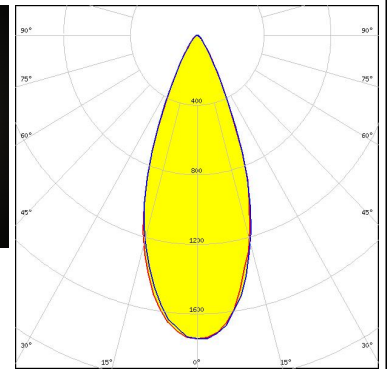
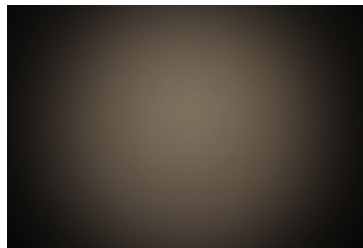

#### PHOTOMETRIC DATA (MEASURED):

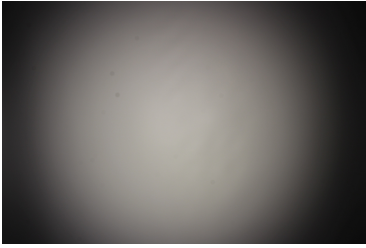
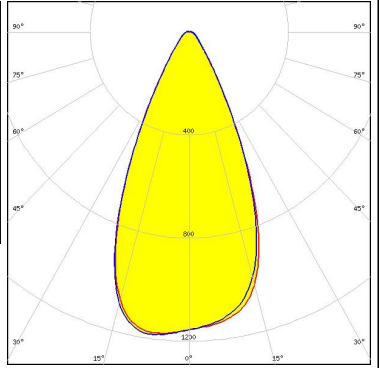
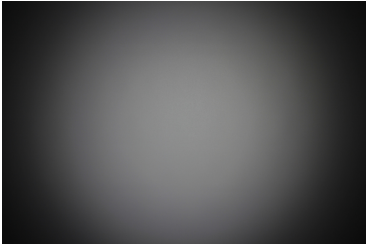
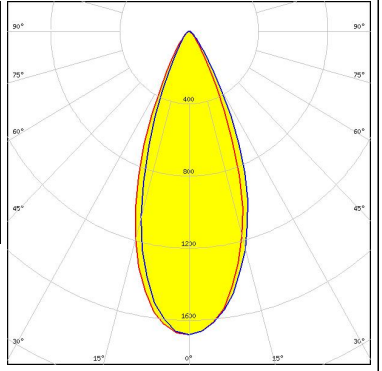
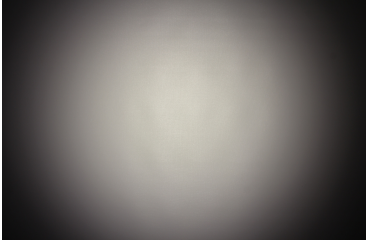
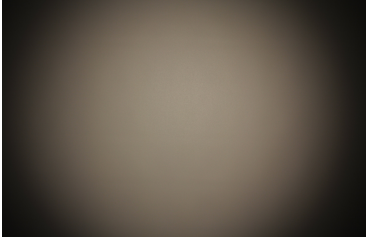
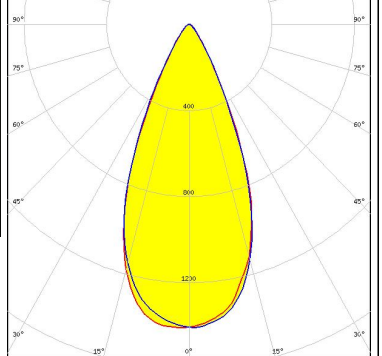
|   |  |   |
|---|--|---|
| <p><b>NICHIA</b></p> <p>LED NVSW219F<br/>           FWHM / FWTM 48.0° / 76.0°<br/>           Efficiency 91 %<br/>           Peak intensity 1.2 cd/lm<br/>           LEDs/each optic 1<br/>           Light colour White<br/>           Required components:</p>   |    |    |
| <p><b>NICHIA</b></p> <p>LED NVSxx19A<br/>           FWHM / FWTM 41.0° / 67.0°<br/>           Efficiency 87 %<br/>           Peak intensity 1.7 cd/lm<br/>           LEDs/each optic 1<br/>           Light colour White<br/>           Required components:</p>   |   |   |
| <p><b>NICHIA</b></p> <p>LED NVSxx19B/NVSxx19C<br/>           FWHM / FWTM 41.0° / 68.0°<br/>           Efficiency 84 %<br/>           Peak intensity 1.7 cd/lm<br/>           LEDs/each optic 1<br/>           Light colour White<br/>           Required components:</p>                                      |  |   |
| <p><b>OSRAM</b><br/> <small>Opto Semiconductors</small></p> <p>LED OSLON Square EC<br/>           FWHM / FWTM 46.0° / 71.0°<br/>           Efficiency 87 %<br/>           Peak intensity 1.4 cd/lm<br/>           LEDs/each optic 1<br/>           Light colour White<br/>           Required components:</p> |  |  |

**PHOTOMETRIC DATA (MEASURED):**

## SAMSUNG

LED LH351D  
 FWHM / FWTM 52.0° / 81.0°  
 Efficiency 92 %  
 Peak intensity 1 cd/lm  
 LEDs/each optic 1  
 Light colour White  
 Required components:

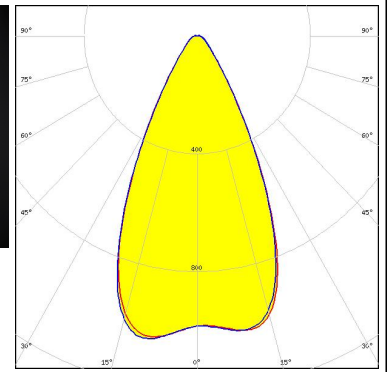
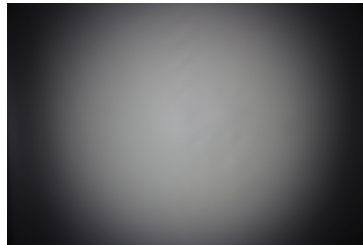

SEOUL SEMICONDUCTOR  
 LED Z5M3  
 FWHM / FWTM 43.0° / 72.0°  
 Efficiency 92 %  
 Peak intensity 1.4 cd/lm  
 LEDs/each optic 1  
 Light colour White  
 Required components:

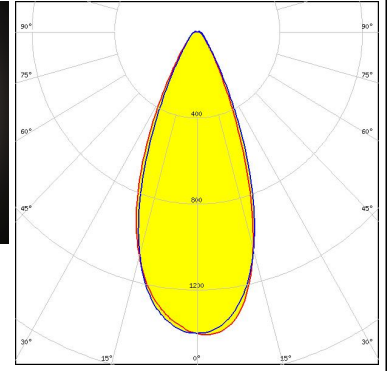

#### PHOTOMETRIC DATA (SIMULATED):



LED XHP35 HI  
 FWHM / FWTM 45.0° / 65.0°  
 Efficiency 93 %  
 Peak intensity 1.7 cd/lm  
 LEDs/each optic 1  
 Light colour White  
 Required components:

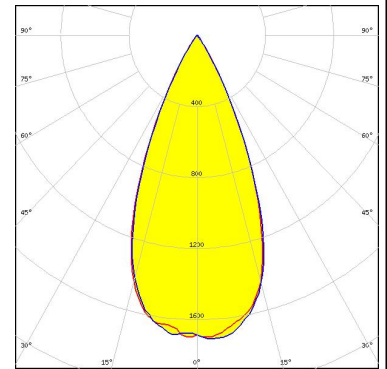

LED XQ-E HI  
 FWHM / FWTM 46.0° / 54.0°  
 Efficiency 95 %  
 Peak intensity 2.1 cd/lm  
 LEDs/each optic 1  
 Light colour White  
 Required components:

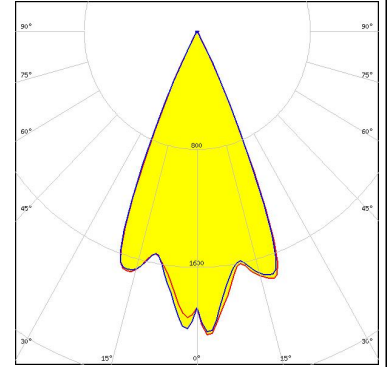

LED OSLOM Black  
 FWHM / FWTM 41.0° / 55.0°  
 Efficiency 95 %  
 Peak intensity 2.3 cd/lm  
 LEDs/each optic 1  
 Light colour White  
 Required components:

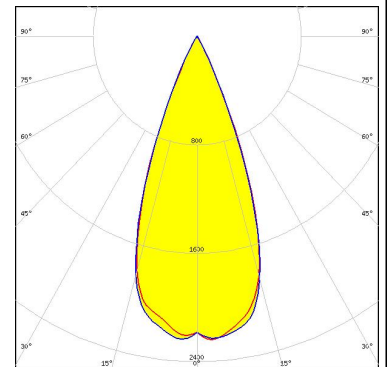

LED OSLOM Black Flat  
 FWHM / FWTM 34.0° / 54.0°  
 Efficiency 94 %  
 Peak intensity 2.9 cd/lm  
 LEDs/each optic 1  
 Light colour White  
 Required components:

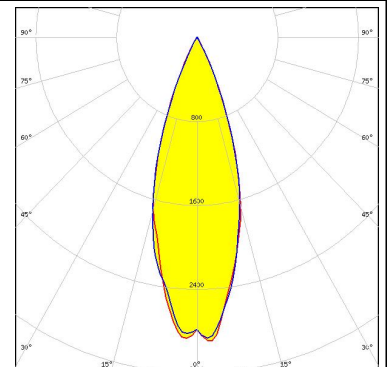

#### PHOTOMETRIC DATA (SIMULATED):

##### OSRAM

Opto Semiconductors

LED OSLON Square Flat  
FWHM / FWTM 41.0° / 59.0°  
Efficiency 94 %  
Peak intensity 2.2 cd/lm  
LEDs/each optic 1  
Light colour White  
Required components:

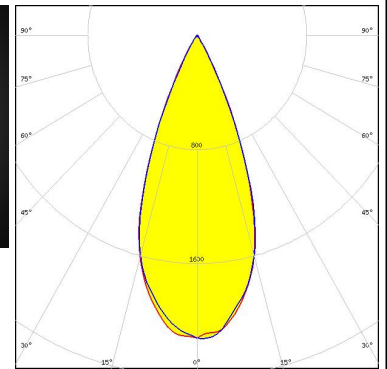
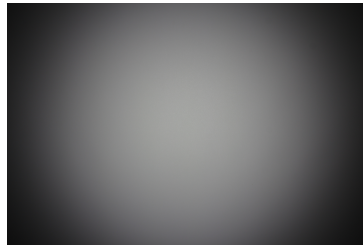

##### OSRAM

Opto Semiconductors

LED SFH 4770S  
FWHM / FWTM 27.0° / 50.0°  
Efficiency 93 %  
LEDs/each optic 1  
Light colour White  
Required components:

##### SEOL

SEOL SEMICONDUCTOR

LED Z8Y22P  
FWHM / FWTM 40.0° / 62.0°  
Efficiency 98 %  
Peak intensity 2.2 cd/lm  
LEDs/each optic 1  
Light colour White  
Required components:

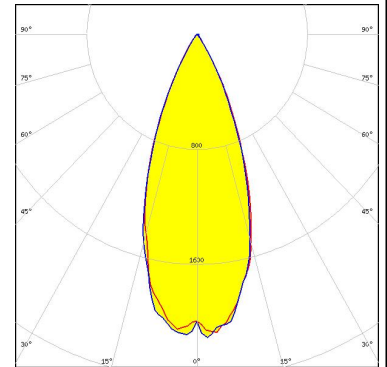

### GENERAL INFORMATION:

NOTE: The typical beam angle will be changed by different color, chip size and chip position tolerance. The typical total beam angle is the full angle measured where the luminous intensity is half of the peak value.

### MATERIALS:

As part of our continuous research and improvement processes, and to ensure the best possible quality and availability of our products, LEDiL reserves the right to change material grades without notice.

### PRODUCT DATA USER AGREEMENT AND DISCLAIMER:

The measured data in the provided downloadable LEDiL Product Datasheets and Mechanical 2D-Drawings is rounded and provided as reference for planning. LEDiL Oy's optical specifications have been verified by conducting performance testing of the products in accordance with the company's quality system. The reported data are averaged results of multiple measurements with typical variation. LEDiL Oy reserves the right to without prior notification make changes and improvements to its products.

LEDiL Oy assumes neither warranty, nor guarantee nor any other liability of any kind for the contents and correctness of the provided data. The provided data has been generated with highest diligence but the provided data may in reality not represent the complete possible variation range of all intrinsic parameters. Therefore, in certain cases a deviation from the provided data could occur.

LEDiL Oy reserves the right to undertake technical changes of its products without further notification which could lead to changes in the provided data. LEDiL Oy assumes no liability of any kind for the possible deviation from any provided data or any other damage resulting from the usage of the provided data.

The user agrees to this disclaimer and user agreement with the download or usage of the provided files.

#### LEDiL Oy

Joensuunkatu 13  
FI-24240 SALO  
Finland

#### LEDiL Inc.

228 West Page Street  
Suite D  
Sycamore IL 60178  
USA

#### Ledil Optics Technology (Shenzhen) Co., Ltd.

# 405 , Block B  
Casic Motor Building  
Shenzhen 518057  
P.R.CHINA

#### Local sales and technical support

[www.ledil.com/  
where\\_to\\_buy](http://www.ledil.com/where_to_buy)

#### Shipping locations

Salo, Finland  
Hong Kong, China

#### Distribution Partners

[www.ledil.com/  
where\\_to\\_buy](http://www.ledil.com/where_to_buy)