

MIRELLA-50-W-PF

~40° wide beam

SPECIFICATION:

Dimensions	Ø 49.9 mm
Height	24 mm
Fastening	socket
ROHS compliant	yes ⓘ

MATERIALS:

Component	Type	Material	Colour	Finish	Coating
MIRELLA-50-W-PF	Reflector	PC	metal		lacquer

ORDERING INFORMATION:





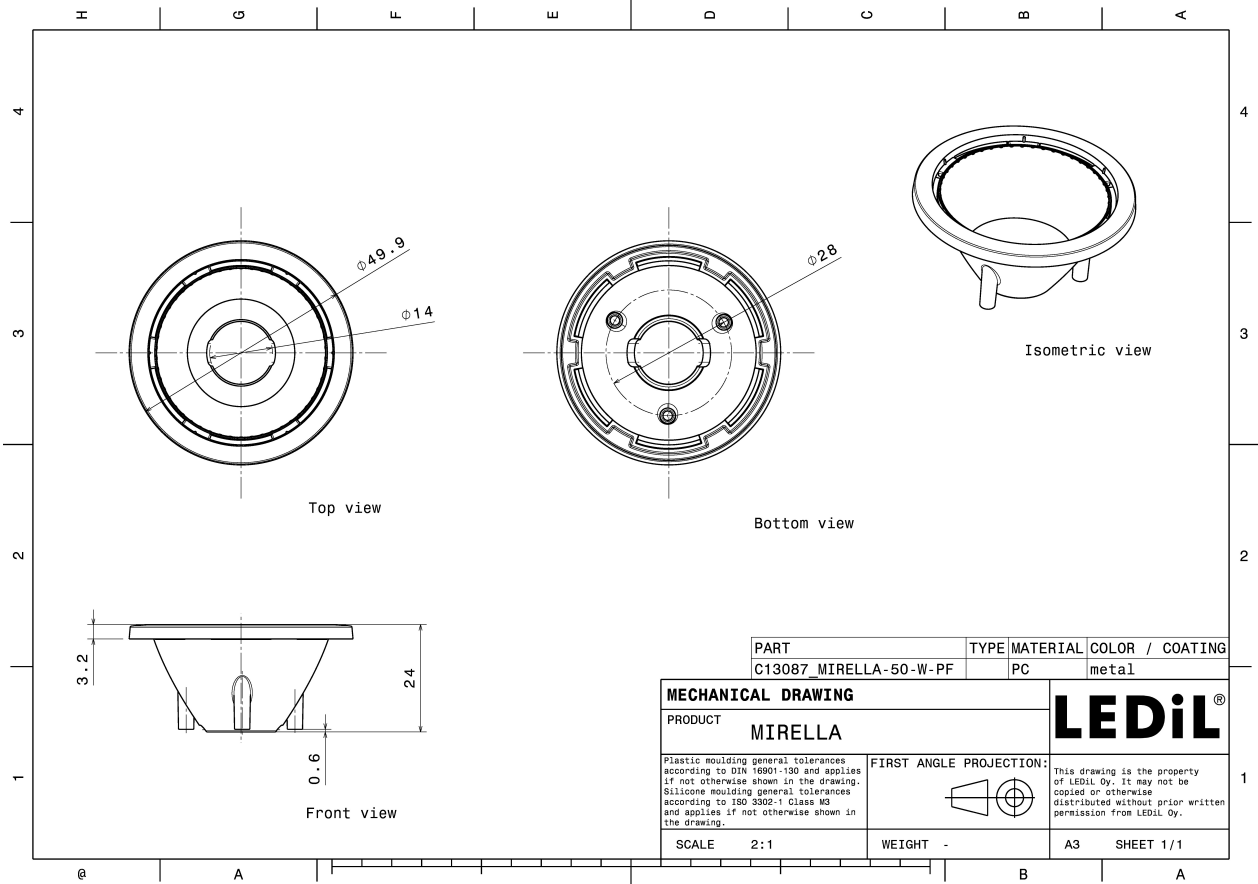

Component	Qty in box	MOQ	MPQ	Box weight (kg)
C13087_MIRELLA-50-W-PF » Box size: 480 x 280 x 300 mm	336	112	28	2.8



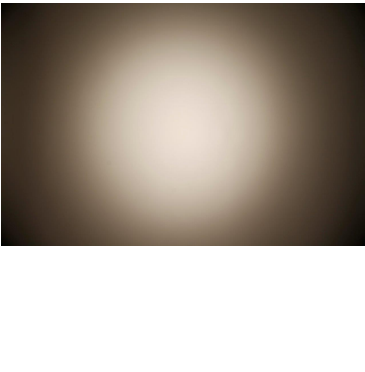
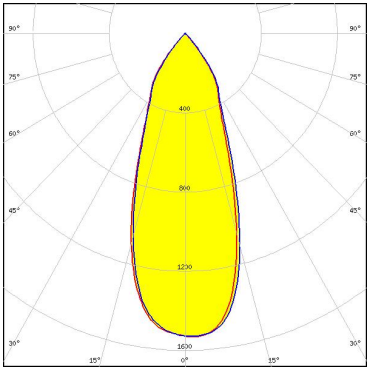

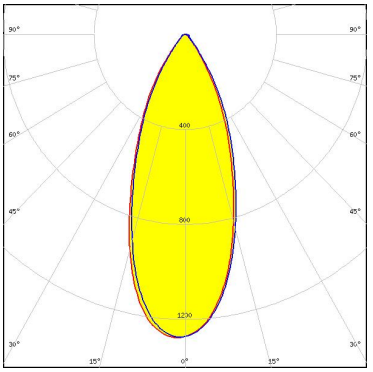

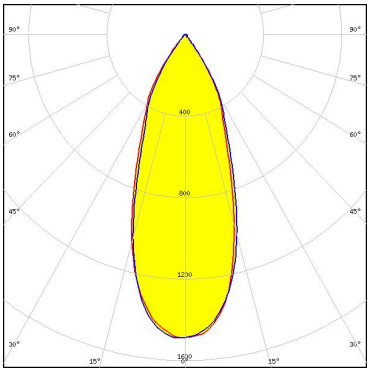

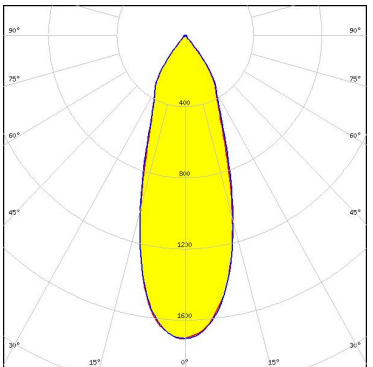
See also our general installation guide: www.ledil.com/installation_guide





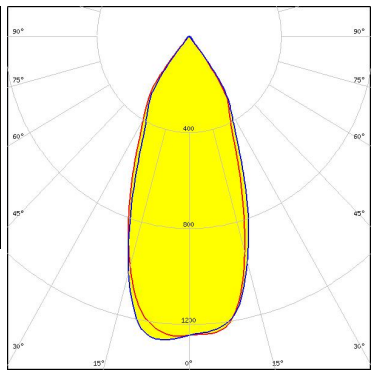

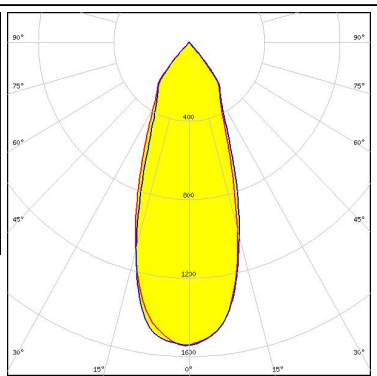
OPTICAL RESULTS (MEASURED):

<p></p> <p>LED V10 Gen6 FWHM / FWTM 39.0° / 79.0° Efficiency 86 % Peak intensity 1.5 cd/lm LEDs/each optic 1 Light colour White Required components: C14115_PF-SOCKET-CXA15-18</p>		
<p></p> <p>LED V10 Gen7 FWHM / FWTM 40.0° / 75.0° Efficiency 77 % Peak intensity 1.3 cd/lm LEDs/each optic 1 Light colour White Required components: C13709_PF-SOCKET-VERO13-18 C12479_MIRELLA-DL</p>		
<p></p> <p>LED V10 Gen7 FWHM / FWTM 39.0° / 73.0° Efficiency 79 % Peak intensity 1.5 cd/lm LEDs/each optic 1 Light colour White Required components: C13709_PF-SOCKET-VERO13-18 C13333_MIRELLA-CL</p>		
<p></p> <p>LED V10 Gen7 FWHM / FWTM 35.0° / 76.0° Efficiency 84 % Peak intensity 1.7 cd/lm LEDs/each optic 1 Light colour White Required components: C13709_PF-SOCKET-VERO13-18</p>		

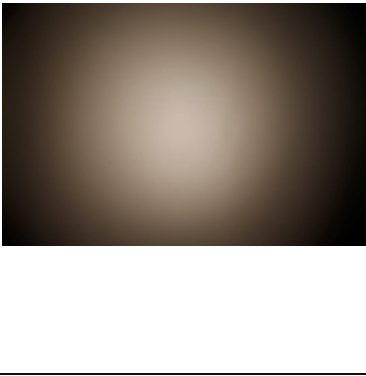
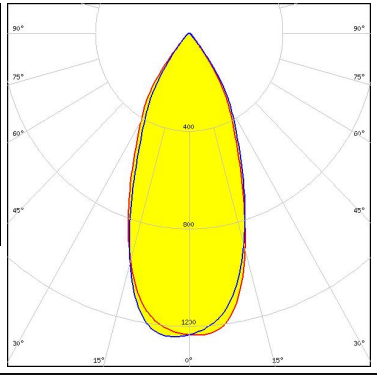

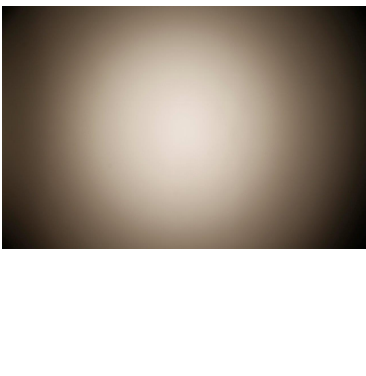
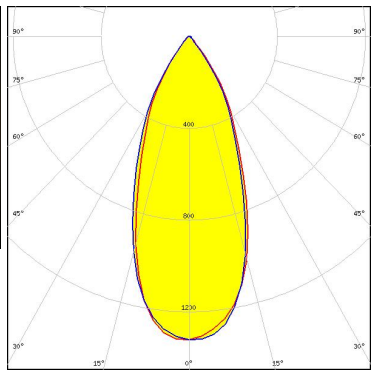
OPTICAL RESULTS (MEASURED):

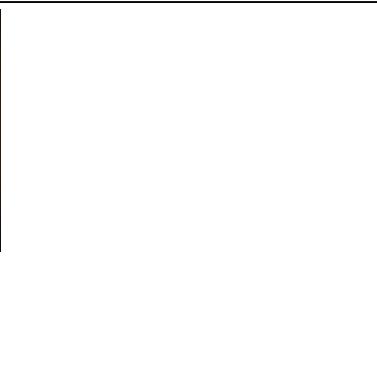
<p>bridgelux.</p> <p>LED V6 Gen6</p> <p>FWHM / FWTM 31.0° / 72.0°</p> <p>Efficiency 74 %</p> <p>Peak intensity 2.1 cd/lm</p> <p>LEDs/each optic 1</p> <p>Light colour White</p> <p>Required components:</p> <p>C13709_PF-SOCKET-VERO13-18</p> <p>C12479_MIRELLA-DL</p> <p>Bender Wirth: 460 Typ L1</p>		
<p>bridgelux.</p> <p>LED V6 Gen6</p> <p>FWHM / FWTM 44.0° / 77.0°</p> <p>Efficiency 81 %</p> <p>Peak intensity 1.3 cd/lm</p> <p>LEDs/each optic 1</p> <p>Light colour White</p> <p>Required components:</p> <p>C13761_PF-SOCKET-CXA15</p> <p>C13333_MIRELLA-CL</p>		
<p>bridgelux.</p> <p>LED V6 Gen6</p> <p>FWHM / FWTM 27.0° / 76.0°</p> <p>Efficiency 82 %</p> <p>Peak intensity 2.7 cd/lm</p> <p>LEDs/each optic 1</p> <p>Light colour White</p> <p>Required components:</p> <p>C13709_PF-SOCKET-VERO13-18</p> <p>Bender Wirth: 460 Typ L1</p>		
<p>bridgelux.</p> <p>LED V6 Gen6</p> <p>FWHM / FWTM 39.0° / 81.0°</p> <p>Efficiency 87 %</p> <p>Peak intensity 1.5 cd/lm</p> <p>LEDs/each optic 1</p> <p>Light colour White</p> <p>Required components:</p> <p>C13761_PF-SOCKET-CXA15</p>		

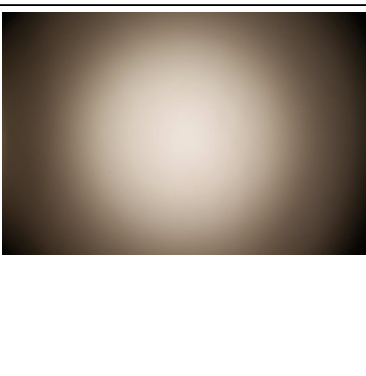
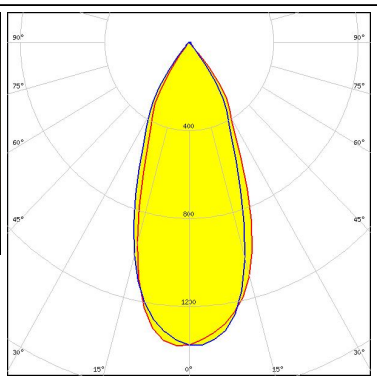



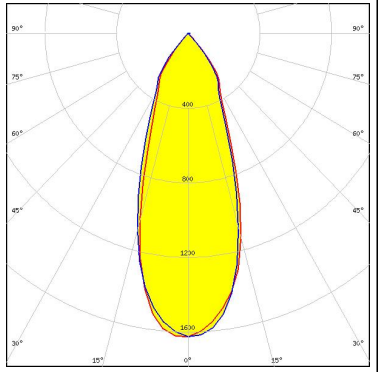
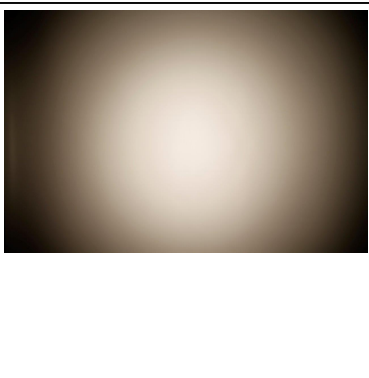
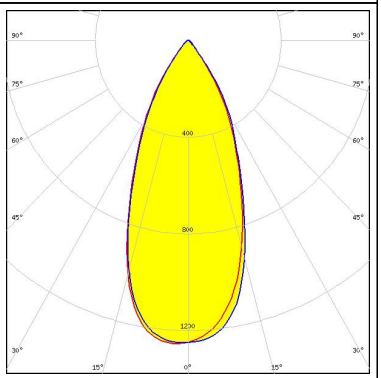

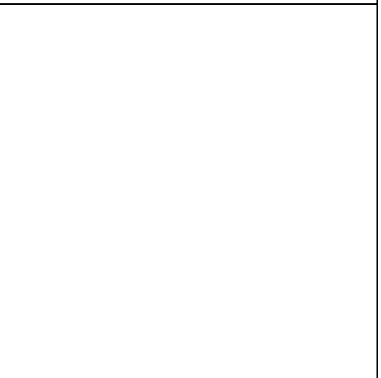
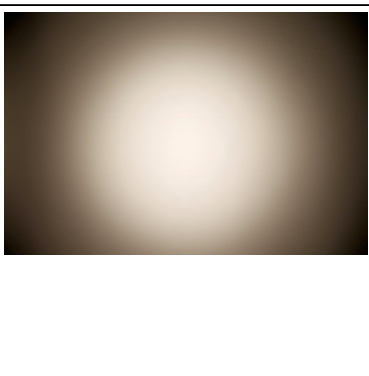
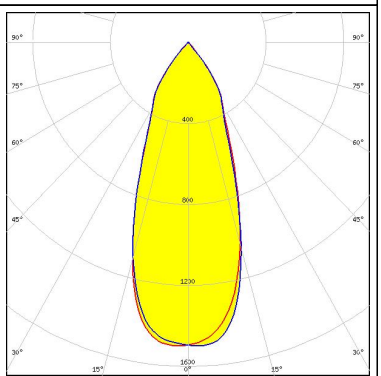
OPTICAL RESULTS (MEASURED):

<p></p> <p>LED V6 Gen6 FWHM / FWTM 44.0° / 78.0° Efficiency 81 % Peak intensity 1.3 cd/lm LEDs/each optic 1 Light colour White</p> <p>Required components: C13761_PF-SOCKET-CXA15 C12479_MIRELLA-DL</p>		
<p></p> <p>LED V8 Gen6 FWHM / FWTM 43.0° / 76.0° Efficiency 82 % Peak intensity 1.3 cd/lm LEDs/each optic 1 Light colour White</p> <p>Required components: C13761_PF-SOCKET-CXA15 C12479_MIRELLA-DL</p>		
<p></p> <p>LED V8 Gen6 FWHM / FWTM 36.0° / 74.0° Efficiency 73 % Peak intensity 1.8 cd/lm LEDs/each optic 1 Light colour White</p> <p>Required components: C13709_PF-SOCKET-VERO13-18 C12479_MIRELLA-DL Bender Wirth: 460 Typ L1</p>		
<p></p> <p>LED V8 Gen6 FWHM / FWTM 42.0° / 76.0° Efficiency 82 % Peak intensity 1.4 cd/lm LEDs/each optic 1 Light colour White</p> <p>Required components: C13761_PF-SOCKET-CXA15 C13333_MIRELLA-CL</p>		

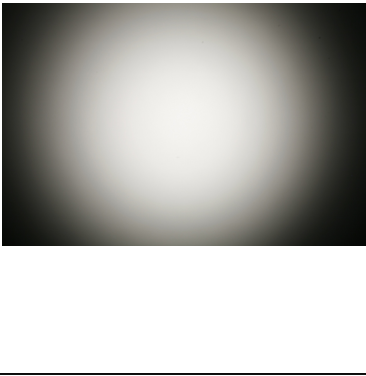
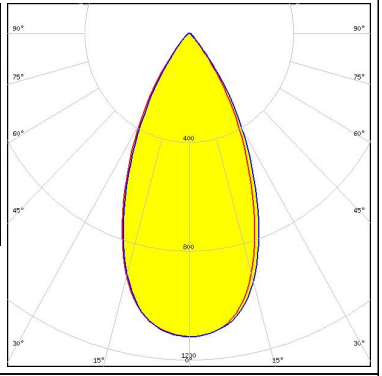

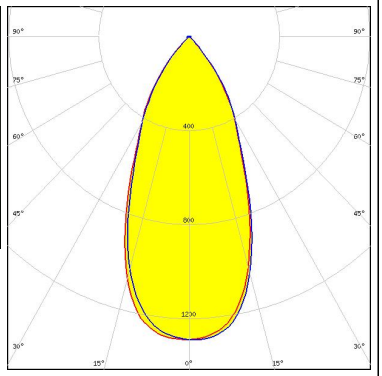

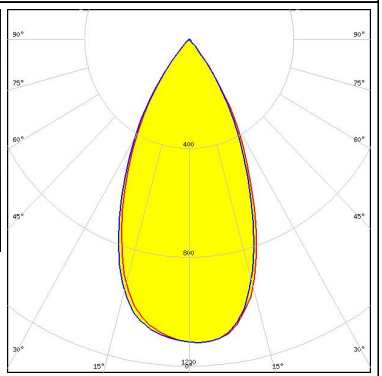

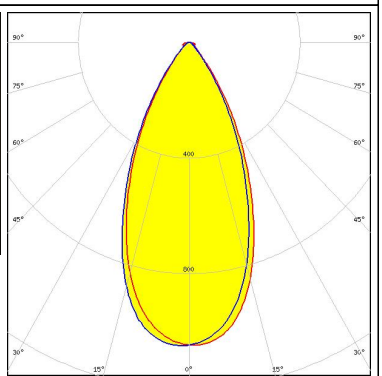
OPTICAL RESULTS (MEASURED):

<p>bridgelux.</p> <p>LED V8 Gen6</p> <p>FWHM / FWTM 38.0° / 79.0°</p> <p>Efficiency 87 %</p> <p>Peak intensity 1.6 cd/m</p> <p>LEDs/each optic 1</p> <p>Light colour White</p> <p>Required components: C13761_PF-SOCKET-CXA15</p>		
<p>bridgelux.</p> <p>LED VERO10</p> <p>FWHM / FWTM 44.0° / 76.0°</p> <p>Efficiency 80 %</p> <p>Peak intensity 1.3 cd/m</p> <p>LEDs/each optic 1</p> <p>Light colour White</p> <p>Required components: C13708_PF-SOCKET-VERO10 C12479_MIRELLA-DL</p>		
<p>bridgelux.</p> <p>LED VERO10</p> <p>FWHM / FWTM 44.0° / 76.0°</p> <p>Efficiency 80 %</p> <p>Peak intensity 1.3 cd/m</p> <p>LEDs/each optic 1</p> <p>Light colour White</p> <p>Required components: C13708_PF-SOCKET-VERO10 C13333_MIRELLA-CL</p>		
<p>bridgelux.</p> <p>LED VERO10</p> <p>FWHM / FWTM 40.0° / 79.0°</p> <p>Efficiency 85 %</p> <p>Peak intensity 1.5 cd/m</p> <p>LEDs/each optic 1</p> <p>Light colour White</p> <p>Required components: C13708_PF-SOCKET-VERO10</p>		

OPTICAL RESULTS (MEASURED):

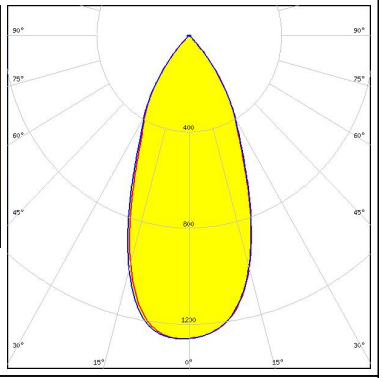
<p>bridgelux.</p> <p>LED VERO13 FWHM / FWTM 50.0° / 79.0° Efficiency 82 % Peak intensity 1.1 cd/lm LEDs/each optic 1 Light colour White</p> <p>Required components: C13709_PF-SOCKET-VERO13-18 C12479_MIRELLA-DL</p>		
<p>bridgelux.</p> <p>LED VERO13 FWHM / FWTM 46.0° / 82.0° Efficiency 90 % Peak intensity 1.3 cd/lm LEDs/each optic 1 Light colour White</p> <p>Required components: C13709_PF-SOCKET-VERO13-18</p>		
<p>bridgelux.</p> <p>LED VERO13 FWHM / FWTM 51.0° / 79.0° Efficiency 77 % Peak intensity 1.1 cd/lm LEDs/each optic 1 Light colour White</p> <p>Required components: C13709_PF-SOCKET-VERO13-18 C13333_MIRELLA-CL</p>		
<p>bridgelux.</p> <p>LED Xenio Point 13mm FWHM / FWTM 48.0° / 80.0° Efficiency 78 % Peak intensity 1.1 cd/lm LEDs/each optic 1 Light colour White</p> <p>Required components: C13709_PF-SOCKET-VERO13-18 C12479_MIRELLA-DL</p>		

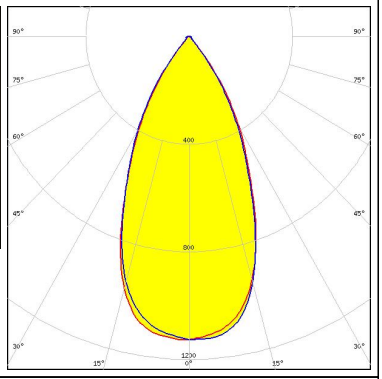
OPTICAL RESULTS (MEASURED):

<p></p> <p>LED Xenio Point 13mm FWHM / FWTM 45.0° / 81.0° Efficiency 85 % Peak intensity 1.3 cd/lm LEDs/each optic 1 Light colour White Required components: C13709_PF-SOCKET-VERO13-18</p>		
<p></p> <p>LED Xenio Point 13mm FWHM / FWTM 49.0° / 78.0° Efficiency 81 % Peak intensity 1.1 cd/lm LEDs/each optic 1 Light colour White Required components: C13709_PF-SOCKET-VERO13-18 C13333_MIRELLA-CL</p>		
<p>CITIZEN</p> <p>LED CLL01x FWHM / FWTM 44.0° / 76.0° Efficiency 86 % Peak intensity 1.4 cd/lm LEDs/each optic 1 Light colour White Required components: C13083_PF-SOCKET C12479_MIRELLA-DL</p>		
<p>CITIZEN</p> <p>LED CLL01x FWHM / FWTM 42.0° / 76.0° Efficiency 86 % Peak intensity 1.4 cd/lm LEDs/each optic 1 Light colour White Required components: C13083_PF-SOCKET C13333_MIRELLA-CL</p>		

OPTICAL RESULTS (MEASURED):

CITIZEN

LED CLL01x
FWHM / FWTM 36.0° / 80.0°
Efficiency 90 %
Peak intensity 1.8 cd/lm
LEDs/each optic 1
Light colour White
Required components:
C13083_PF-SOCKET



CITIZEN

LED CLL02x/CLU02x (LES10)
FWHM / FWTM 46.0° / 78.0°
Efficiency 86 %
Peak intensity 1.5 cd/lm
LEDs/each optic 1
Light colour White
Required components:
C13083_PF-SOCKET
C13333_MIRELLA-CL

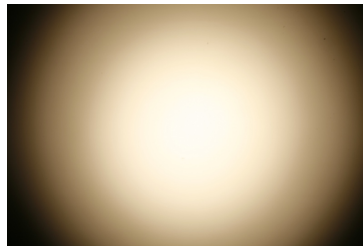

CITIZEN

LED CLL02x/CLU02x (LES10)
FWHM / FWTM 41.0° / 80.0°
Efficiency 90 %
Peak intensity 1.8 cd/lm
LEDs/each optic 1
Light colour White
Required components:
C13083_PF-SOCKET

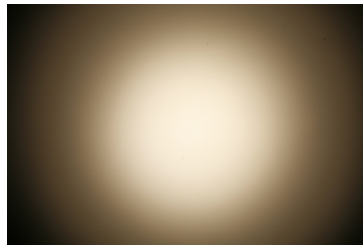

CITIZEN

LED CLL02x/CLU02x (LES10)
FWHM / FWTM 46.0° / 77.0°
Efficiency 86 %
Peak intensity 1.5 cd/lm
LEDs/each optic 1
Light colour White
Required components:
C13083_PF-SOCKET
C12479_MIRELLA-DL

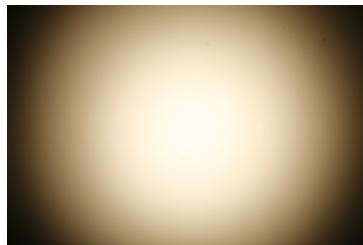

OPTICAL RESULTS (MEASURED):

CITIZEN

LED CLL02x/CLU02x (LES10)
 FWHM / FWTM 46.0° / 80.0°
 Efficiency %
 Peak intensity 0.7 cd/m
 LEDs/each optic 1
 Light colour White
 Required components:
 C13083_PF-SOCKET
 C13723_MIRELLA-RZL

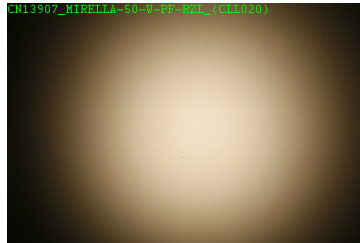

CITIZEN

LED CLL02x/CLU02x (LES10)
 FWHM / FWTM 36.0° / 77.0°
 Efficiency 84 %
 Peak intensity 1.7 cd/m
 LEDs/each optic 1
 Light colour White
 Required components:
 C13709_PF-SOCKET-VERO13-18
 Bender Wirth: 434 Typ L1

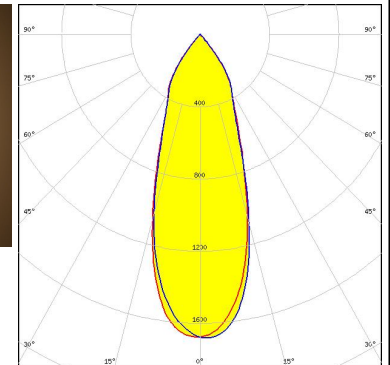
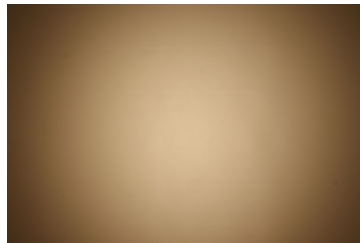

CITIZEN

LED CLL02x/CLU02x (LES10)
 FWHM / FWTM 39.0° / 73.0°
 Efficiency 78 %
 Peak intensity 1.5 cd/m
 LEDs/each optic 1
 Light colour White
 Required components:
 C13709_PF-SOCKET-VERO13-18
 C13333_MIRELLA-CL
 Bender Wirth: 434 Typ L1

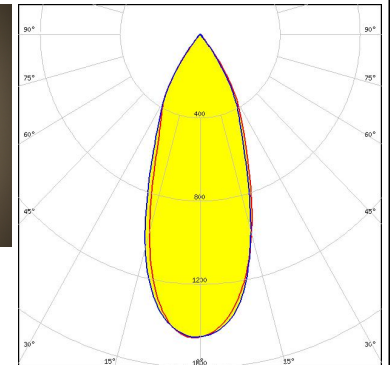
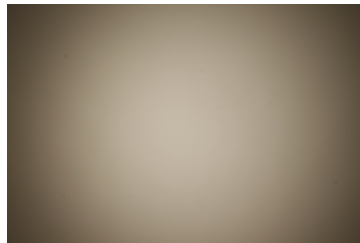

CITIZEN

LED CLL02x/CLU02x (LES10)
 FWHM / FWTM 41.0° / 76.0°
 Efficiency 76 %
 Peak intensity 1.3 cd/m
 LEDs/each optic 1
 Light colour White
 Required components:
 C13709_PF-SOCKET-VERO13-18
 C12479_MIRELLA-DL
 Bender Wirth: 434 Typ L1

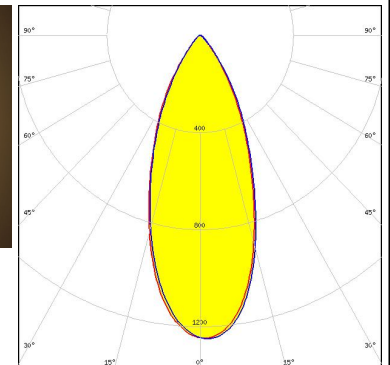
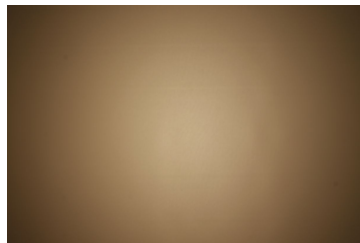

OPTICAL RESULTS (MEASURED):

CITIZEN

LED CLU700/701/702/703
 FWHM / FWTM 39.0° / 75.0°
 Efficiency 82 %
 Peak intensity 1.4 cd/m
 LEDs/each optic 1
 Light colour White
 Required components:
 C13083_PF-SOCKET
 C12479_MIRELLA-DL

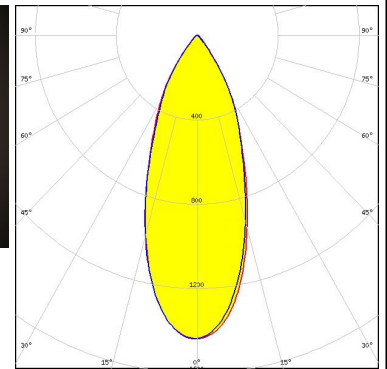
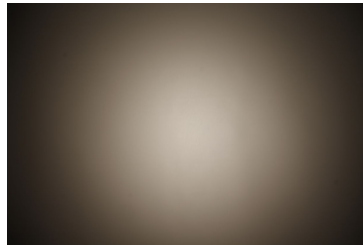

CITIZEN

LED CLU700/701/702/703
 FWHM / FWTM 26.0° / 73.0°
 Efficiency 83 %
 Peak intensity 2.4 cd/m
 LEDs/each optic 1
 Light colour White
 Required components:
 C13709_PF-SOCKET-VERO13-18
 Bender Wirth: 434 Typ L1

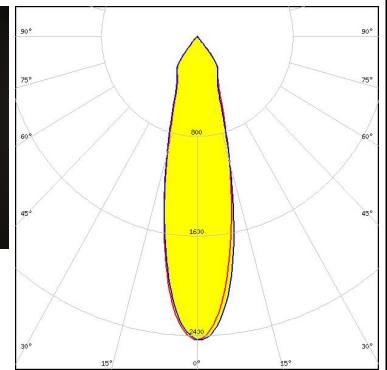
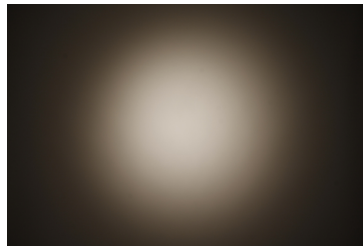

CITIZEN

LED CLU700/701/702/703
 FWHM / FWTM 29.0° / 69.0°
 Efficiency 80 %
 Peak intensity 2.1 cd/m
 LEDs/each optic 1
 Light colour White
 Required components:
 C13709_PF-SOCKET-VERO13-18
 C13333_MIRELLA-CL
 Bender Wirth: 434 Typ L1

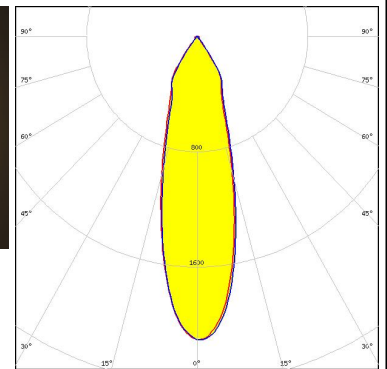
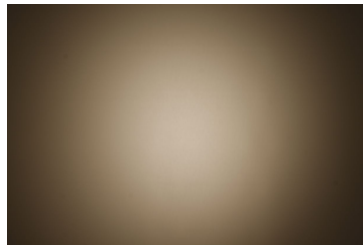

CITIZEN

LED CLU700/701/702/703
 FWHM / FWTM 33.0° / 78.0°
 Efficiency 88 %
 Peak intensity 1.9 cd/m
 LEDs/each optic 1
 Light colour White
 Required components:
 C13083_PF-SOCKET

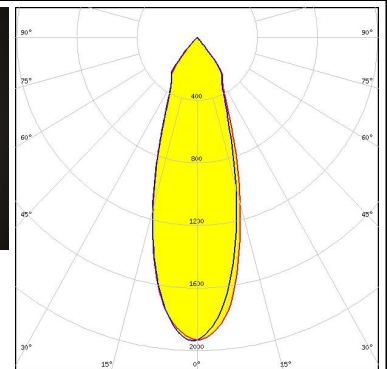
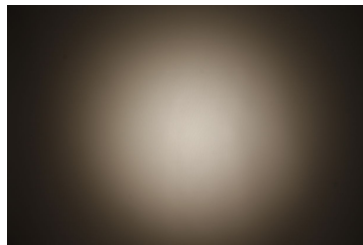

OPTICAL RESULTS (MEASURED):

CITIZEN

LED CLU700/701/702/703
 FWHM / FWTM 31.0° / 70.0°
 Efficiency 77 %
 Peak intensity 1.8 cd/lm
 LEDs/each optic 1
 Light colour White
 Required components:
 C13709_PF-SOCKET-VERO13-18
 C12479_MIRELLA-DL
 Bender Wirth: 434 Typ L1

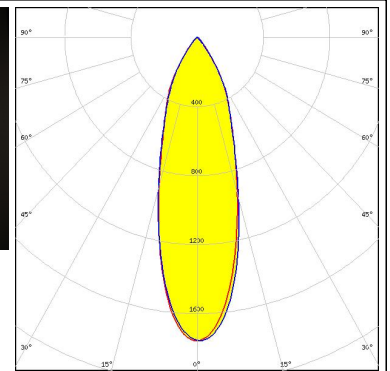

CITIZEN

LED CLU700/701/702/703
 FWHM / FWTM 34.0° / 72.0°
 Efficiency 81 %
 Peak intensity 1.8 cd/lm
 LEDs/each optic 1
 Light colour White
 Required components:
 C13083_PF-SOCKET
 C13333_MIRELLA-CL

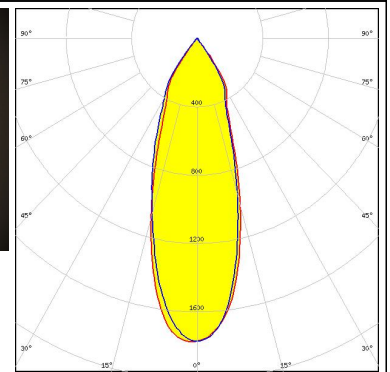
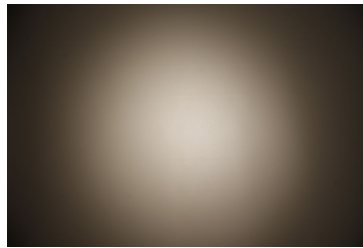

CITIZEN

LED CLU700/701/702/703
 FWHM / FWTM 42.0° / 78.0°
 Efficiency 81 %
 Peak intensity 1.3 cd/lm
 LEDs/each optic 1
 Light colour White
 Required components:
 C13083_PF-SOCKET
 C13723_MIRELLA-RZL

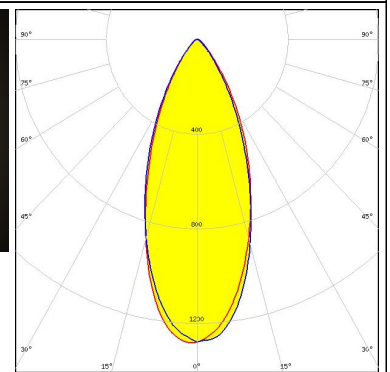
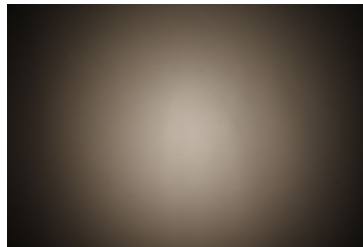

CITIZEN

LED CLU720/721/723
 FWHM / FWTM 44.0° / 78.0°
 Efficiency 74 %
 Peak intensity 1.1 cd/lm
 LEDs/each optic 1
 Light colour White
 Required components:
 C13709_PF-SOCKET-VERO13-18
 C12479_MIRELLA-DL
 Bender Wirth: 433 Typ L1

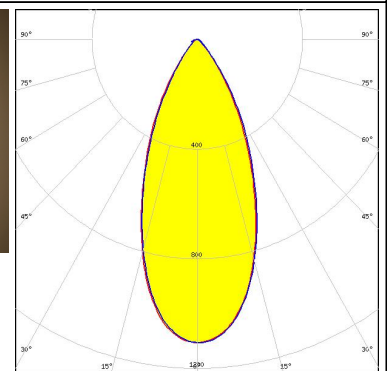
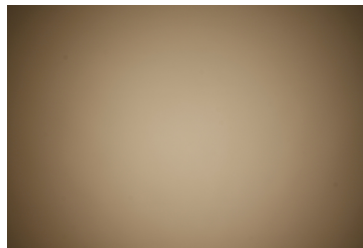

OPTICAL RESULTS (MEASURED):

CITIZEN

LED CLU720/721/723
 FWHM / FWTM 43.0° / 74.0°
 Efficiency 76 %
 Peak intensity 1.3 cd/m
 LEDs/each optic 1
 Light colour White
 Required components:
 C13709_PF-SOCKET-VERO13-18
 C13333_MIRELLA-CL
 Bender Wirth: 433 Typ L1

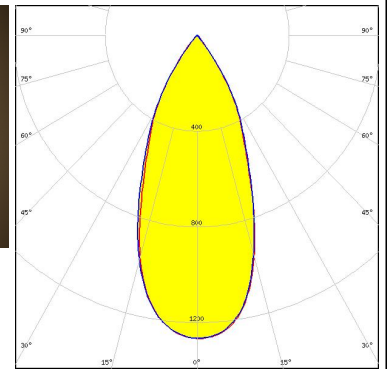
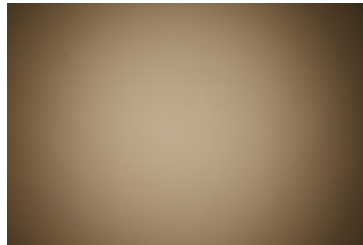

CITIZEN

LED CLU720/721/723
 FWHM / FWTM 40.0° / 78.0°
 Efficiency 81 %
 Peak intensity 1.4 cd/m
 LEDs/each optic 1
 Light colour White
 Required components:
 C13709_PF-SOCKET-VERO13-18
 Bender Wirth: 433 Typ L1

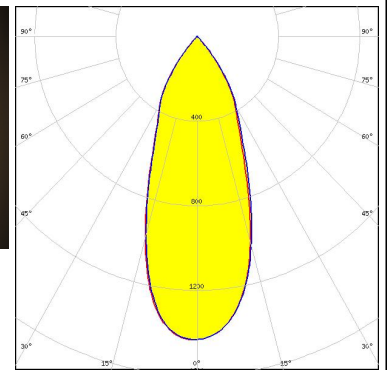
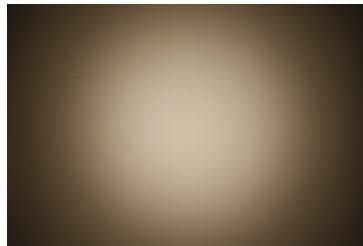

CREE LED

LED CXA/B 13xx
 FWHM / FWTM 42.0° / 76.0°
 Efficiency 81 %
 Peak intensity 1.5 cd/m
 LEDs/each optic 1
 Light colour White
 Required components:
 C13761_PF-SOCKET-CXA15
 C13333_MIRELLA-CL

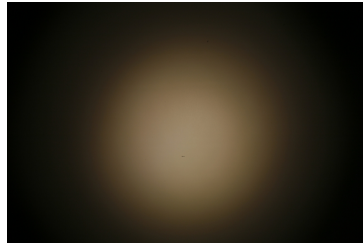





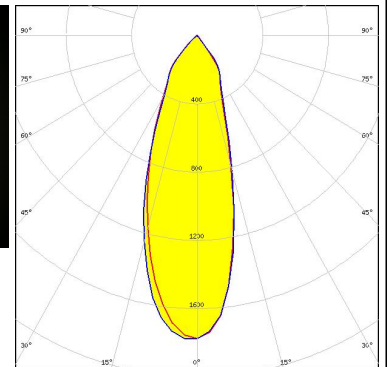
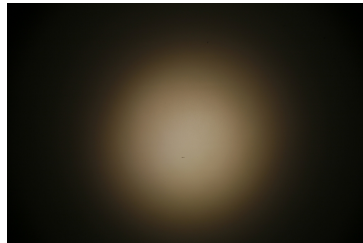

CREE LED

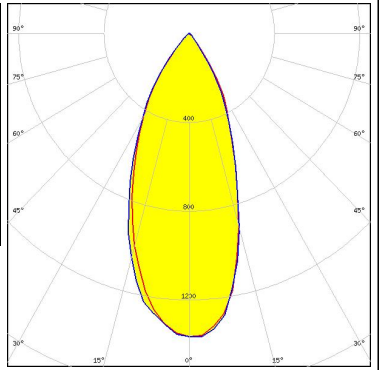

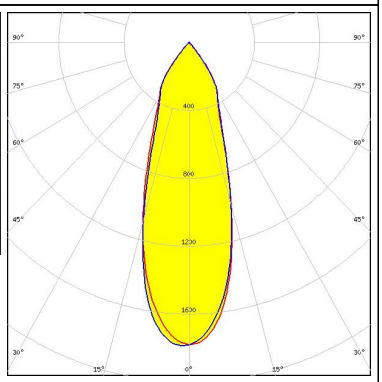

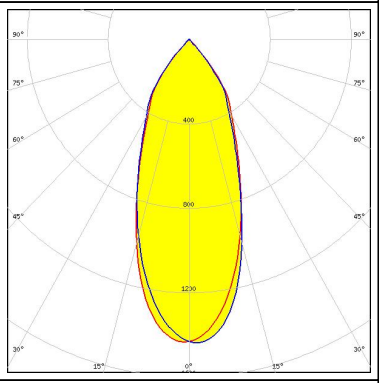
LED CXA/B 13xx
 FWHM / FWTM 37.0° / 80.0°
 Efficiency 86 %
 Peak intensity 1.8 cd/m
 LEDs/each optic 1
 Light colour White
 Required components:
 C13761_PF-SOCKET-CXA15

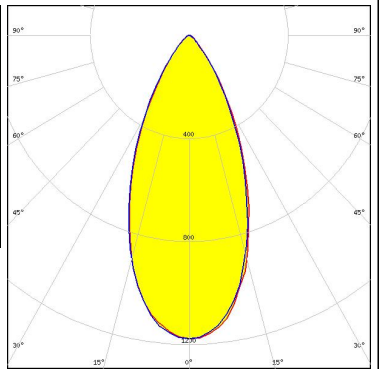

OPTICAL RESULTS (MEASURED):

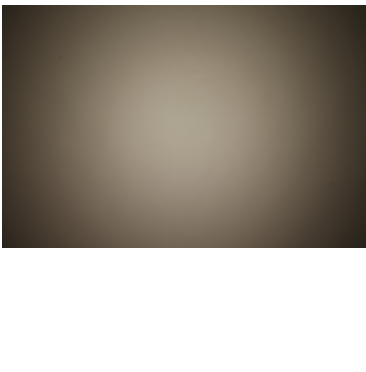
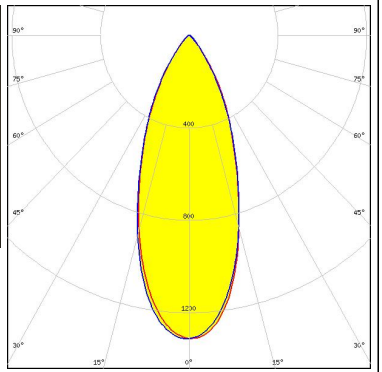
<p>CREE → LED</p> <p>LED CXA/B 13xx FWHM / FWTM 43.0° / 76.0° Efficiency 81 % Peak intensity 1.4 cd/lm LEDs/each optic 1 Light colour White</p> <p>Required components: C13761_PF-SOCKET-CXA15 C12479_MIRELLA-DL</p>		
<p>CREE → LED</p> <p>LED CXA/B 15xx FWHM / FWTM 34.0° / 75.0° Efficiency 82 % Peak intensity 1.8 cd/lm LEDs/each optic 1 Light colour White</p> <p>Required components: C13709_PF-SOCKET-VERO13-18 Bender Wirth: 441 Typ L1</p>		
<p>CREE → LED</p> <p>LED CXA/B 15xx FWHM / FWTM 41.0° / 82.0° Efficiency 90 % Peak intensity 1.4 cd/lm LEDs/each optic 1 Light colour White</p> <p>Required components: C13761_PF-SOCKET-CXA15</p>		
<p>CREE → LED</p> <p>LED CXA/B 15xx FWHM / FWTM 47.0° / 81.0° Efficiency 81 % Peak intensity 1.2 cd/lm LEDs/each optic 1 Light colour White</p> <p>Required components: C13761_PF-SOCKET-CXA15 C13723_MIRELLA-RZL</p>		

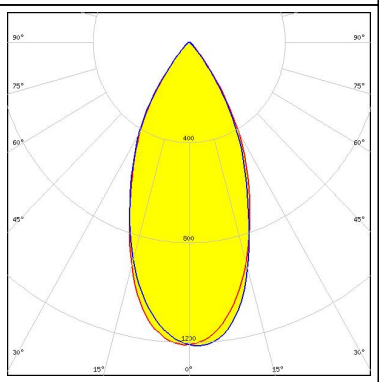
OPTICAL RESULTS (MEASURED):

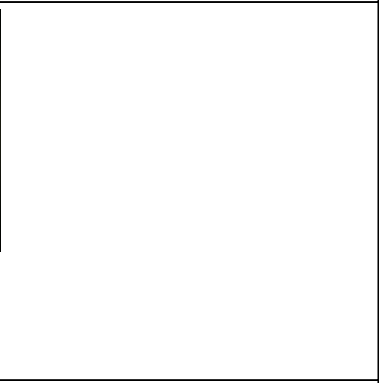
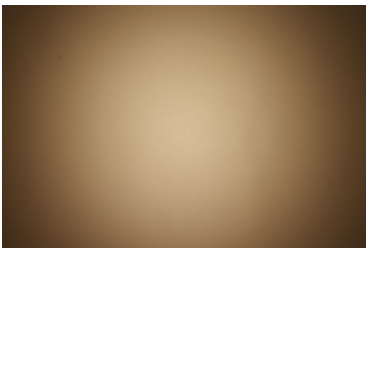
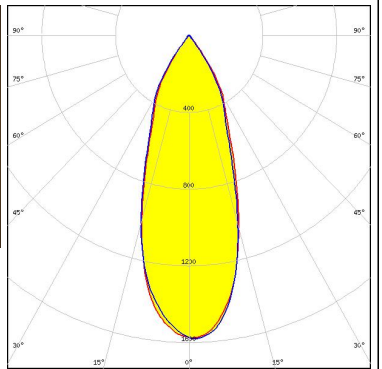
<p>CREE → LED</p> <p>LED CXA/B 15xx FWHM / FWTM 39.0° / 75.0° Efficiency 75 % Peak intensity 1.3 cd/lm LEDs/each optic 1 Light colour White</p> <p>Required components: C13709_PF-SOCKET-VERO13-18 C12479_MIRELLA-DL Bender Wirth: 441 Typ L1</p>		
<p>CREE → LED</p> <p>LED CXA/B 15xx FWHM / FWTM 47.0° / 79.0° Efficiency 85 % Peak intensity 1.2 cd/lm LEDs/each optic 1 Light colour White</p> <p>Required components: C13761_PF-SOCKET-CXA15 C12479_MIRELLA-DL</p>		
<p>CREE → LED</p> <p>LED CXA/B 15xx FWHM / FWTM 46.0° / 79.0° Efficiency 85 % Peak intensity 1.4 cd/lm LEDs/each optic 1 Light colour White</p> <p>Required components: C13761_PF-SOCKET-CXA15 C13333_MIRELLA-CL</p>		
<p>CREE → LED</p> <p>LED CXA/B 15xx FWHM / FWTM 37.0° / 72.0° Efficiency 79 % Peak intensity 1.6 cd/lm LEDs/each optic 1 Light colour White</p> <p>Required components: C13709_PF-SOCKET-VERO13-18 C13333_MIRELLA-CL Bender Wirth: 441 Typ L1</p>		

OPTICAL RESULTS (MEASURED):

CREE LED

LED CXA/B 1816 & CXA/B 1820 & CXA 1850
 FWHM / FWTM 45.0° / 81.0°
 Efficiency 84 %
 Peak intensity 1.3 cd/lm
 LEDs/each optic 1
 Light colour White
 Required components:
 C14115_PF-SOCKET-CXA15-18

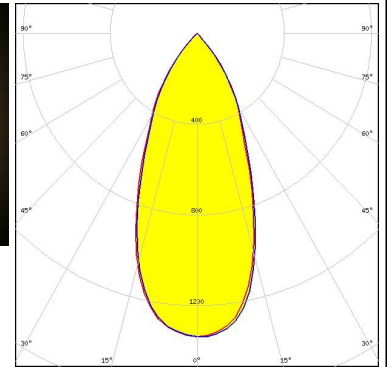
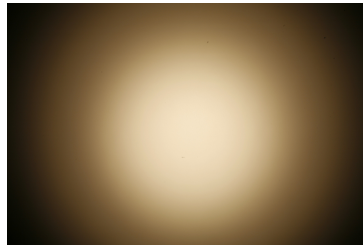

CREE LED

LED CXA/B 1816 & CXA/B 1820 & CXA 1850
 FWHM / FWTM 43.0° / 81.0°
 Efficiency 87 %
 Peak intensity 1.4 cd/lm
 LEDs/each optic 1
 Light colour White
 Required components:
 IDEAL: 50-2101CR + 50-2100MR

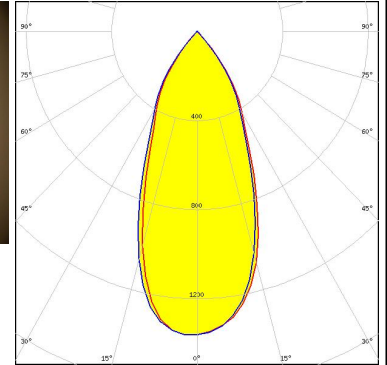
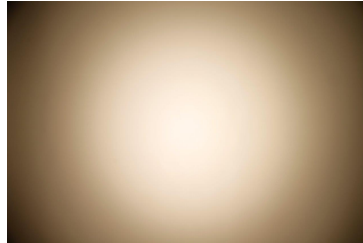

CREE LED

LED MHD-E/G
 FWHM / FWTM 38.0° / 82.0°
 Efficiency 89 %
 Peak intensity 1.5 cd/lm
 LEDs/each optic 1
 Light colour White
 Required components:
 C13083_PF-SOCKET

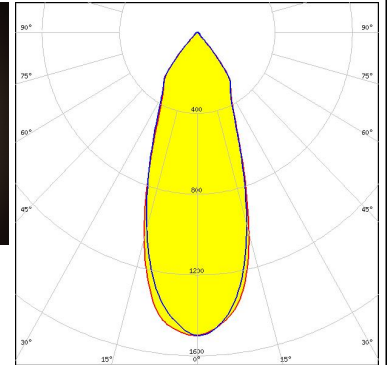
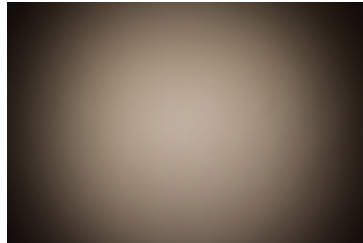





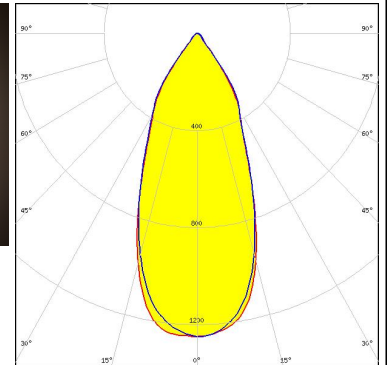
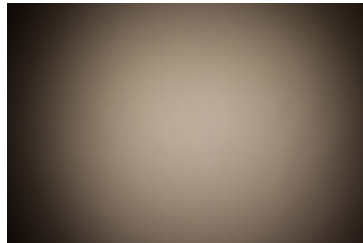

CREE LED

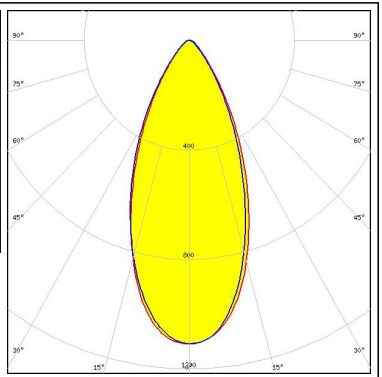
LED MHD-E/G
 FWHM / FWTM 44.0° / 77.0°
 Efficiency 84 %
 Peak intensity 1.3 cd/lm
 LEDs/each optic 1
 Light colour White
 Required components:
 C13083_PF-SOCKET
 C13333_MIRELLA-CL

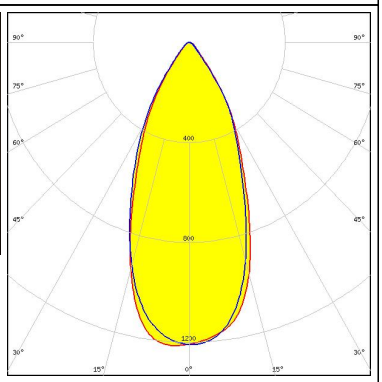

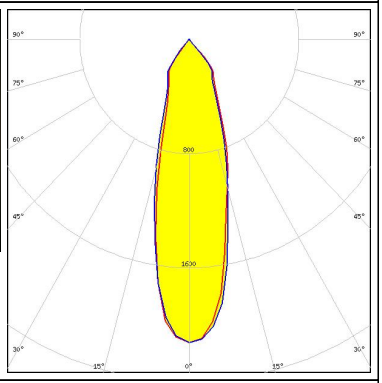
OPTICAL RESULTS (MEASURED):

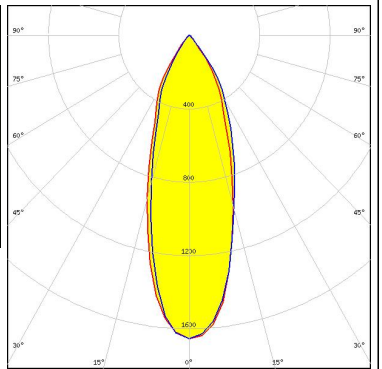
<p>CREE LED</p> <p>LED MHD-E/G FWHM / FWTM 45.0° / 83.0° Efficiency 82 % Peak intensity 1.1 cd/m LEDs/each optic 1 Light colour White</p> <p>Required components: C13083_PF-SOCKET C13723_MIRELLA-RZL</p>		
<p>CREE LED</p> <p>LED MHD-E/G FWHM / FWTM 45.0° / 78.0° Efficiency 84 % Peak intensity 1.2 cd/m LEDs/each optic 1 Light colour White</p> <p>Required components: C13083_PF-SOCKET C12479_MIRELLA-DL</p>		
<p>CREE LED</p> <p>LED MK-R FWHM / FWTM 30.0° / 77.0° Efficiency 85 % Peak intensity 2.1 cd/m LEDs/each optic 1 Light colour White</p> <p>Required components: C13083_PF-SOCKET</p>		
<p>CREE LED</p> <p>LED MK-R FWHM / FWTM 34.0° / 73.0° Efficiency 80 % Peak intensity 1.7 cd/m LEDs/each optic 1 Light colour White</p> <p>Required components: C13083_PF-SOCKET C12479_MIRELLA-DL</p>		

OPTICAL RESULTS (MEASURED):

CREE LED

LED MT-G
FWHM / FWTM 52.0° / 84.0°
Efficiency 86 %
Peak intensity 1.2 cd/lm
LEDs/each optic 1
Light colour White
Required components:
C13083_PF-SOCKET
C12479_MIRELLA-DL



CREE LED

LED MT-G
FWHM / FWTM 48.0° / 87.0°
Efficiency 90 %
Peak intensity 1.4 cd/lm
LEDs/each optic 1
Light colour White
Required components:
C13083_PF-SOCKET

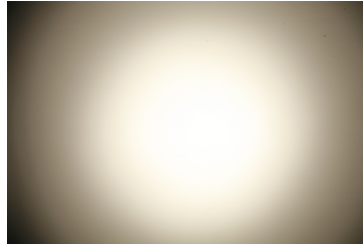

CREE LED

LED MT-G
FWHM / FWTM 52.0° / 83.0°
Efficiency 86 %
Peak intensity 1.2 cd/lm
LEDs/each optic 1
Light colour White
Required components:
C13083_PF-SOCKET
C13333_MIRELLA-CL



CREE LED

LED MT-G2
FWHM / FWTM 51.0° / 82.0°
Efficiency 87 %
Peak intensity 1.2 cd/lm
LEDs/each optic 1
Light colour White
Required components:
C13083_PF-SOCKET
C12479_MIRELLA-DL

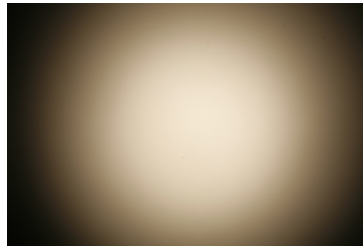

OPTICAL RESULTS (MEASURED):

CREE LED

LED MT-G2
 FWHM / FWTM 46.0° / 86.0°
 Efficiency 91 %
 Peak intensity 0.8 cd/lm
 LEDs/each optic 1
 Light colour White
 Required components:
 C13083_PF-SOCKET



CREE LED

LED MT-G2
 FWHM / FWTM 50.0° / 81.0°
 Efficiency 87 %
 Peak intensity 1.2 cd/lm
 LEDs/each optic 1
 Light colour White
 Required components:
 C13083_PF-SOCKET
 C13333_MIRELLA-CL



CREE LED

LED XHP50
 FWHM / FWTM 33.0° / 80.0°
 Efficiency 87 %
 Peak intensity 1.8 cd/lm
 LEDs/each optic 1
 Light colour White
 Required components:
 C13083_PF-SOCKET

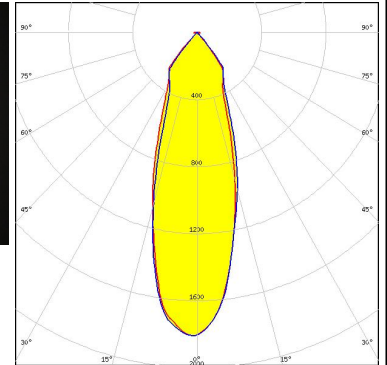
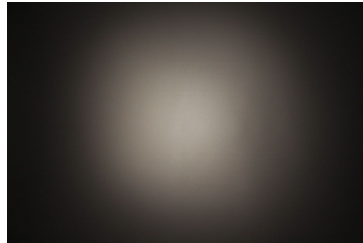



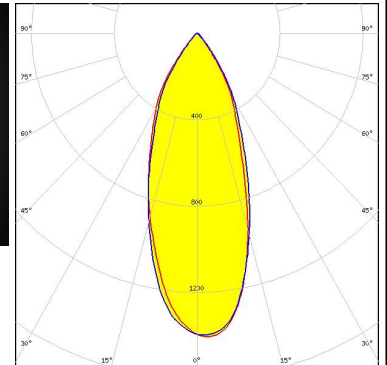
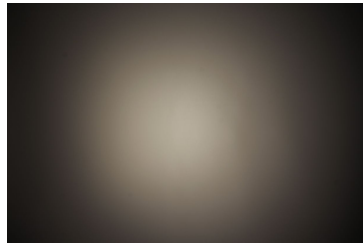

CREE LED



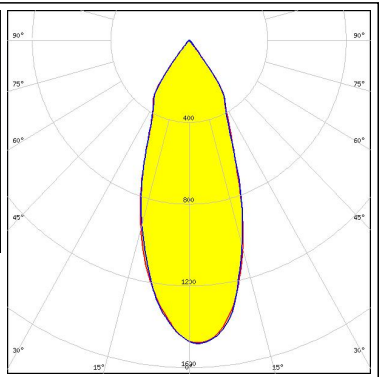

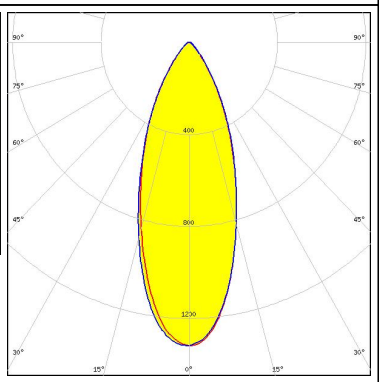

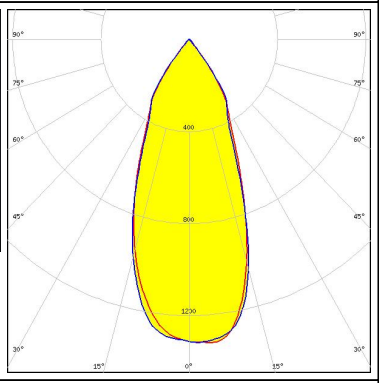
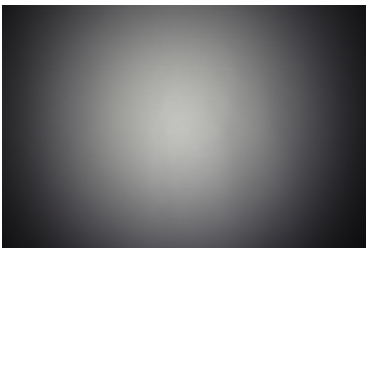
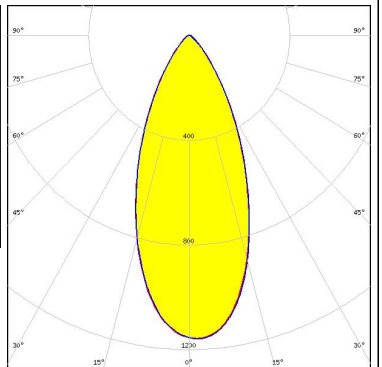
LED XHP50
 FWHM / FWTM 39.0° / 76.0°
 Efficiency 82 %
 Peak intensity 1.4 cd/lm
 LEDs/each optic 1
 Light colour White
 Required components:
 C13083_PF-SOCKET
 C12479_MIRELLA-DL

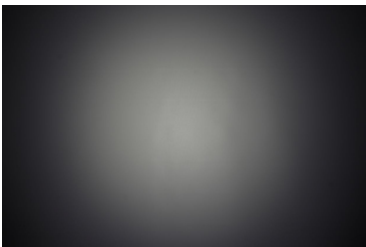
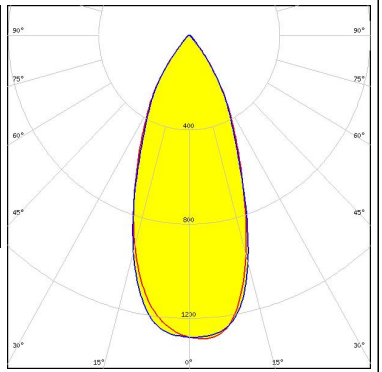

OPTICAL RESULTS (MEASURED):

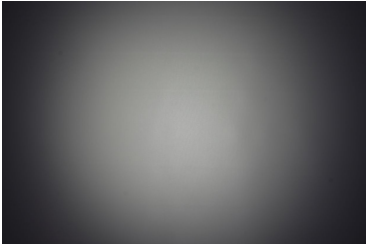
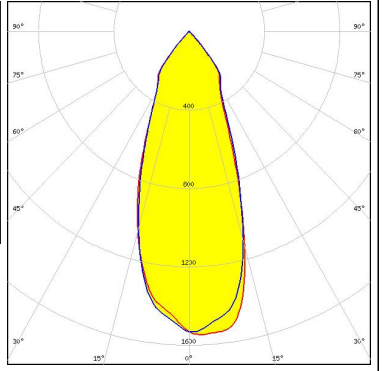
<p>CREE LED</p> <p>LED XHP50 FWHM / FWTM 39.0° / 76.0° Efficiency 81 % Peak intensity 1.5 cd/lm LEDs/each optic 1 Light colour White</p> <p>Required components: C13083_PF-SOCKET C13333_MIRELLA-CL</p>		
<p>CREE LED</p> <p>LED XHP50 FWHM / FWTM 38.0° / 77.0° Efficiency 80 % Peak intensity 1.3 cd/lm LEDs/each optic 1 Light colour White</p> <p>Required components: C13083_PF-SOCKET C13723_MIRELLA-RZL</p>		
<p>CREE LED</p> <p>LED XHP70 FWHM / FWTM 42.0° / 77.0° Efficiency 81 % Peak intensity 1.3 cd/lm LEDs/each optic 1 Light colour White</p> <p>Required components: C13083_PF-SOCKET C13333_MIRELLA-CL</p>		
<p>CREE LED</p> <p>LED XHP70 FWHM / FWTM 44.0° / 80.0° Efficiency 79 % Peak intensity 1.2 cd/lm LEDs/each optic 1 Light colour White</p> <p>Required components: C13083_PF-SOCKET C13723_MIRELLA-RZL</p>		

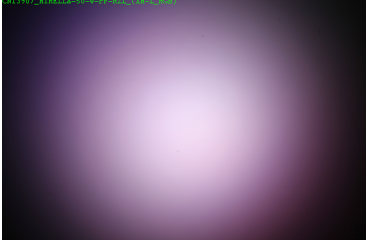
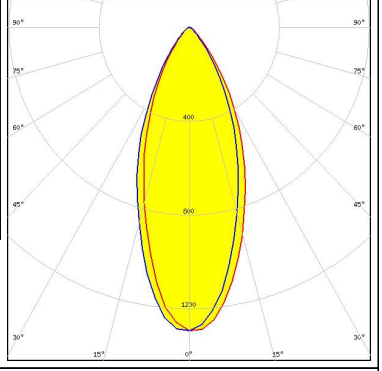
OPTICAL RESULTS (MEASURED):

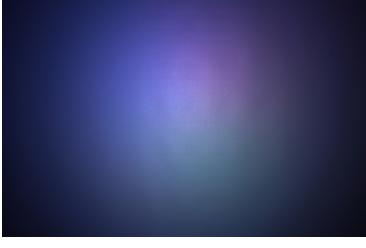
<p>CREE  LED</p> <p>LED XHP70 FWHM / FWTM 43.0° / 77.0° Efficiency 81 % Peak intensity 1.3 cd/m LEDs/each optic 1 Light colour White Required components: C13083_PF-SOCKET C12479_MIRELLA-DL</p>		
<p>CREE  LED</p> <p>LED XHP70 FWHM / FWTM 39.0° / 82.0° Efficiency 86 % Peak intensity 1.5 cd/m LEDs/each optic 1 Light colour White Required components: C13083_PF-SOCKET</p>		
<p>CREE  LED</p> <p>LED XM-L RGBW (XMLCTW) FWHM / FWTM 41.0° / 80.0° Efficiency 80 % Peak intensity 1.3 cd/m LEDs/each optic 1 Light colour White Required components: C13083_PF-SOCKET C13723_MIRELLA-RZL</p>		
<p>CREE  LED</p> <p>LED XQ-E HI FWHM / FWTM 42.0° / 82.0° Efficiency 87 % Peak intensity 1.4 cd/m LEDs/each optic 4 Light colour RGBW Required components: C13083_PF-SOCKET C13723_MIRELLA-RZL</p>		

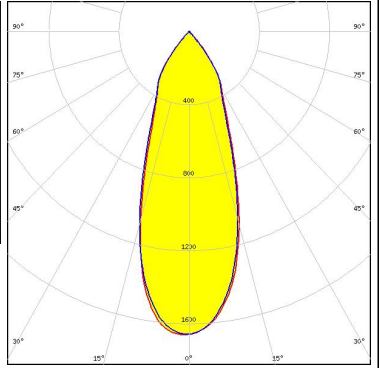
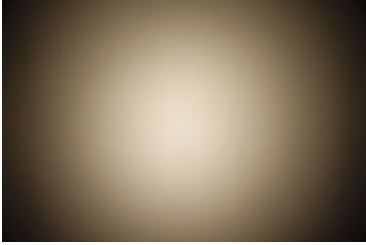
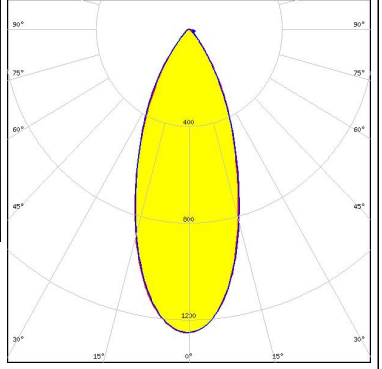
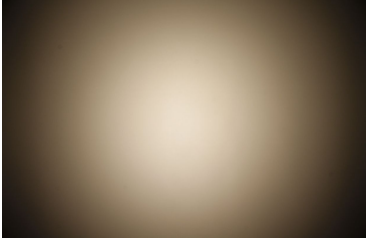
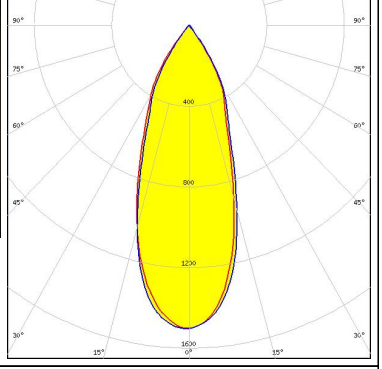
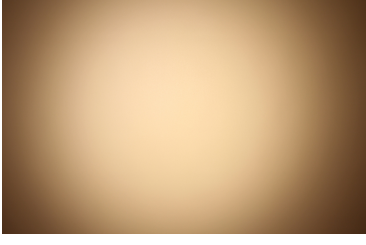
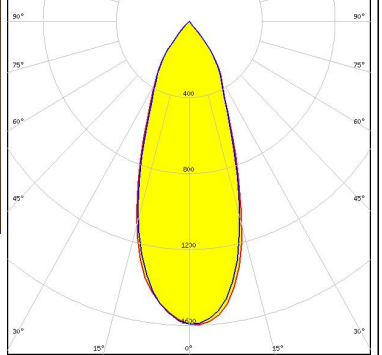

OPTICAL RESULTS (MEASURED):

<p>LUMILEDS</p> <p>LED LUXEON CoB 1202/1203</p> <p>FWHM / FWTM 37.0° / 78.0°</p> <p>Efficiency 87 %</p> <p>Peak intensity 1.7 cd/m</p> <p>LEDs/each optic 1</p> <p>Light colour White</p> <p>Required components: IDEAL: 50-2100NC +50-2100MR</p>		
<p>LUMILEDS</p> <p>LED LUXEON CoB 1202/1203</p> <p>FWHM / FWTM 40.0° / 75.0°</p> <p>Efficiency 75 %</p> <p>Peak intensity 1.3 cd/m</p> <p>LEDs/each optic 1</p> <p>Light colour White</p> <p>Required components: C13709_PF-SOCKET-VERO13-18 C12479_MIRELLA-DL Bender Wirth: 438 Typ L1</p>		
<p>LUMILEDS</p> <p>LED LUXEON CoB 1202/1203</p> <p>FWHM / FWTM 37.0° / 72.0°</p> <p>Efficiency 77 %</p> <p>Peak intensity 1.5 cd/m</p> <p>LEDs/each optic 1</p> <p>Light colour White</p> <p>Required components: C13709_PF-SOCKET-VERO13-18 C13333_MIRELLA-CL Bender Wirth: 438 Typ L1</p>		
<p>LUMILEDS</p> <p>LED LUXEON CoB 1202/1203</p> <p>FWHM / FWTM 39.0° / 79.0°</p> <p>Efficiency 86 %</p> <p>Peak intensity 1.6 cd/m</p> <p>LEDs/each optic 1</p> <p>Light colour White</p> <p>Required components: C14037_PF-NSX-SOCKET</p>		

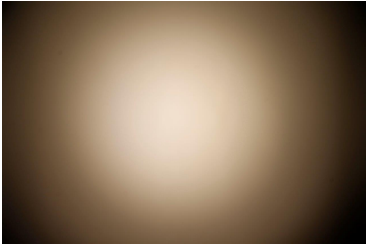
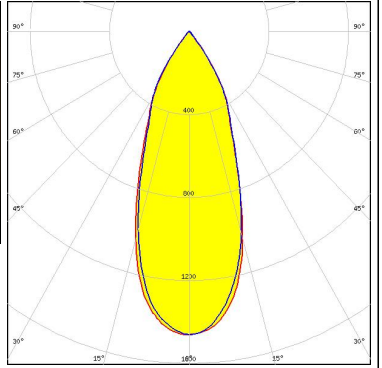
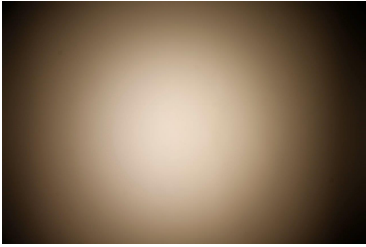
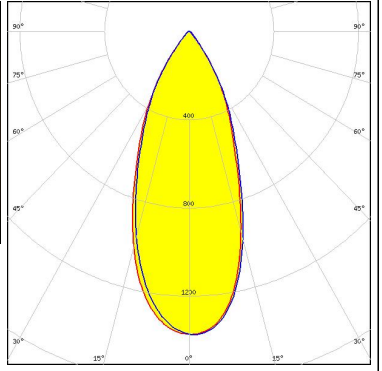
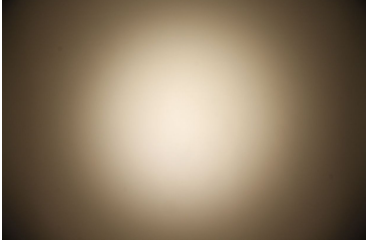
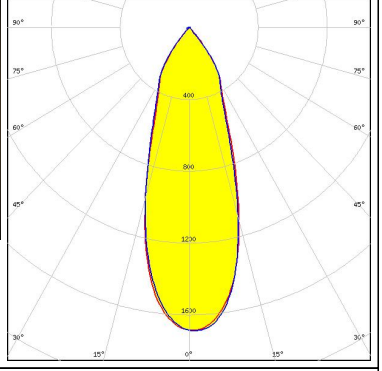
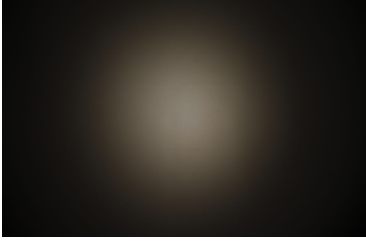
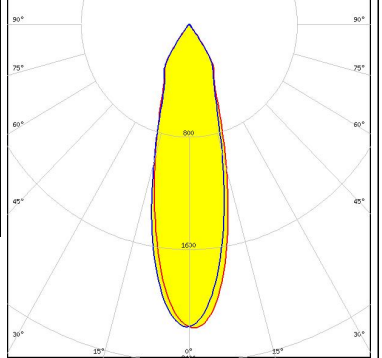
OPTICAL RESULTS (MEASURED):

<p>LUMILEDS</p> <p>LED LUXEON CoB 1202/1203</p> <p>FWHM / FWTM 39.0° / 74.0°</p> <p>Efficiency 80 %</p> <p>Peak intensity 1.5 cd/lm</p> <p>LEDs/each optic 1</p> <p>Light colour White</p> <p>Required components: C13333_MIRELLA-CL IDEAL: 50-2100NC +50-2100MR</p>		
<p>LUMILEDS</p> <p>LED LUXEON CoB 1202/1203</p> <p>FWHM / FWTM 41.0° / 75.0°</p> <p>Efficiency 81 %</p> <p>Peak intensity 1.4 cd/lm</p> <p>LEDs/each optic 1</p> <p>Light colour White</p> <p>Required components: C12479_MIRELLA-DL IDEAL: 50-2100NC +50-2100MR</p>		
<p>LUMILEDS</p> <p>LED LUXEON CoB 1202/1203</p> <p>FWHM / FWTM 35.0° / 76.0°</p> <p>Efficiency 83 %</p> <p>Peak intensity 1.7 cd/lm</p> <p>LEDs/each optic 1</p> <p>Light colour White</p> <p>Required components: C13709_PF-SOCKET-VERO13-18 Bender Wirth: 438 Typ L1</p>		
<p>LUMILEDS</p> <p>LED LUXEON CoB 1202s</p> <p>FWHM / FWTM 28.0° / 69.0°</p> <p>Efficiency 81 %</p> <p>Peak intensity 2.2 cd/lm</p> <p>LEDs/each optic 1</p> <p>Light colour White</p> <p>Required components: C13709_PF-SOCKET-VERO13-18 C13333_MIRELLA-CL Bender Wirth: 452 Typ L1</p>		

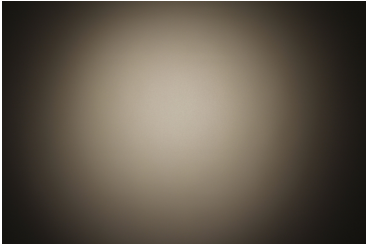
OPTICAL RESULTS (MEASURED):

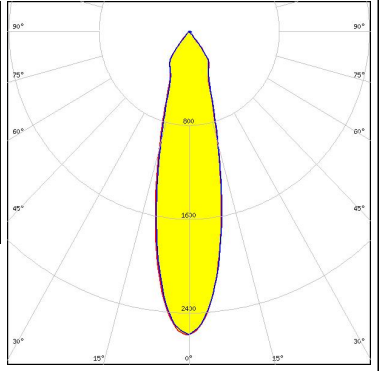
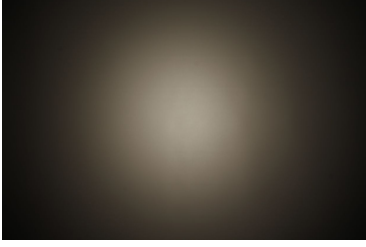
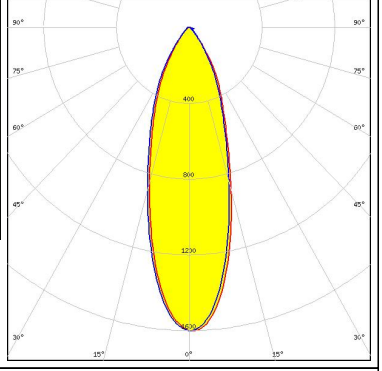
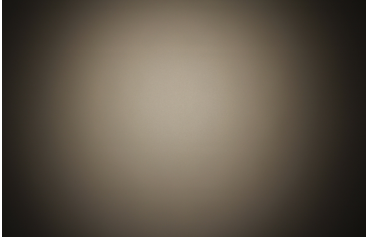
<p>LUMILEDS</p> <p>LED LUXEON CoB 1202s</p> <p>FWHM / FWTM 35.0° / 82.0°</p> <p>Efficiency 88 %</p> <p>Peak intensity 1.9 cd/m</p> <p>LEDs/each optic 1</p> <p>Light colour White</p> <p>Required components: C13761_PF-SOCKET-CXA15</p>		
<p>LUMILEDS</p> <p>LED LUXEON CoB 1202s</p> <p>FWHM / FWTM 25.0° / 72.0°</p> <p>Efficiency 85 %</p> <p>Peak intensity 2.6 cd/m</p> <p>LEDs/each optic 1</p> <p>Light colour White</p> <p>Required components: C13709_PF-SOCKET-VERO13-18 Bender Wirth: 452 Typ L1</p>		
<p>LUMILEDS</p> <p>LED LUXEON CoB 1202s</p> <p>FWHM / FWTM 32.0° / 71.0°</p> <p>Efficiency 77 %</p> <p>Peak intensity 1.6 cd/m</p> <p>LEDs/each optic 1</p> <p>Light colour White</p> <p>Required components: C13709_PF-SOCKET-VERO13-18 C12479_MIRELLA-DL Bender Wirth: 452 Typ L1</p>		
<p>LUMILEDS</p> <p>LED LUXEON CoB 1202s</p> <p>FWHM / FWTM 40.0° / 78.0°</p> <p>Efficiency 82 %</p> <p>Peak intensity 1.5 cd/m</p> <p>LEDs/each optic 1</p> <p>Light colour White</p> <p>Required components: C13761_PF-SOCKET-CXA15 C12479_MIRELLA-DL</p>		

OPTICAL RESULTS (MEASURED):

LUMILEDS

LED LUXEON CoB 1202s
 FWHM / FWTM 41.0° / 78.0°
 Efficiency 82 %
 Peak intensity 1.5 cd/lm
 LEDs/each optic 1
 Light colour White
 Required components:
 C13761_PF-SOCKET-CXA15
 C13333_MIRELLA-CL

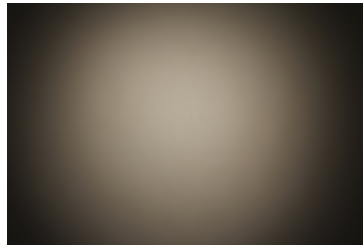

LUMILEDS

LED LUXEON Z
 FWHM / FWTM 36.0° / 75.0°
 Efficiency 79 %
 Peak intensity 1.5 cd/lm
 LEDs/each optic 4
 Light colour RGBW
 Required components:
 C13083_PF-SOCKET
 C13723_MIRELLA-RZL

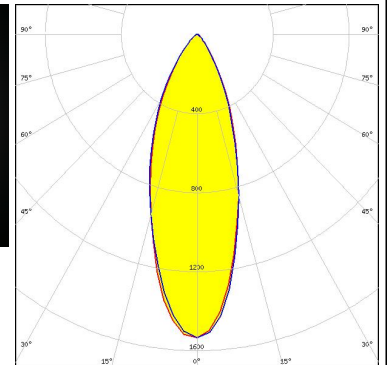
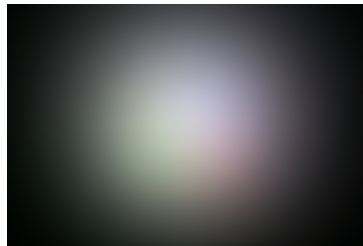

LUMINUS

LED CxM-6 (12x13)
 FWHM / FWTM 36.0° / 79.0°
 Efficiency 85 %
 Peak intensity 1.8 cd/lm
 LEDs/each optic 1
 Light colour White
 Required components:
 C13083_PF-SOCKET

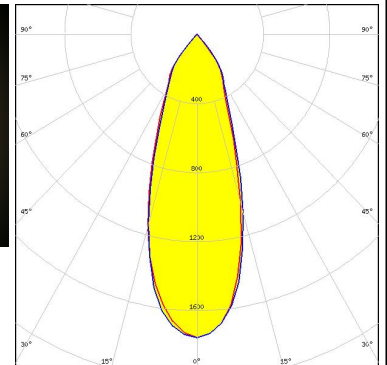
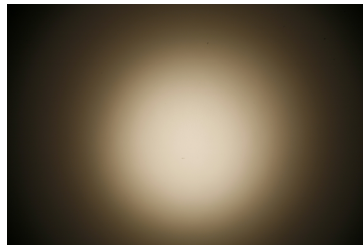

LUMINUS

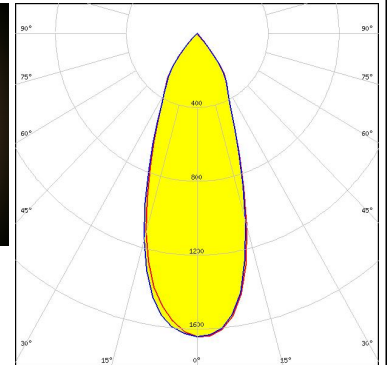
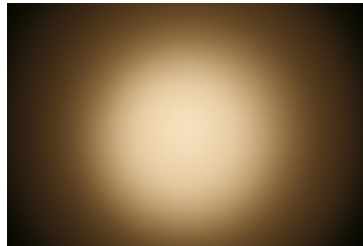

LED CXM-7 (13x13)
 FWHM / FWTM 38.0° / 79.0°
 Efficiency 86 %
 Peak intensity 1.6 cd/lm
 LEDs/each optic 1
 Light colour White
 Required components:
 C13083_PF-SOCKET



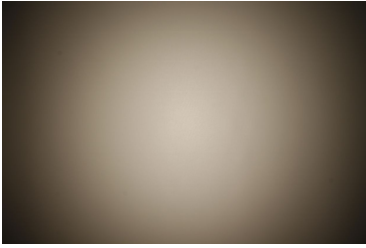
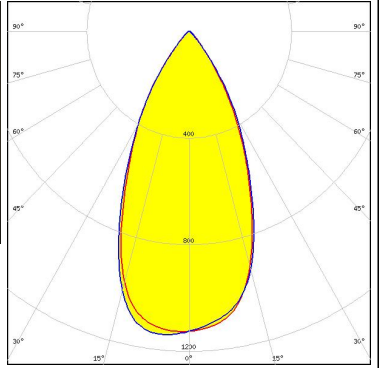
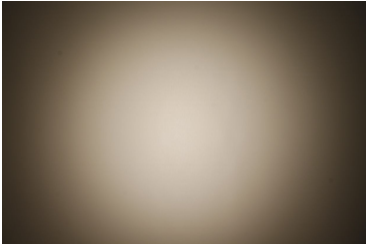
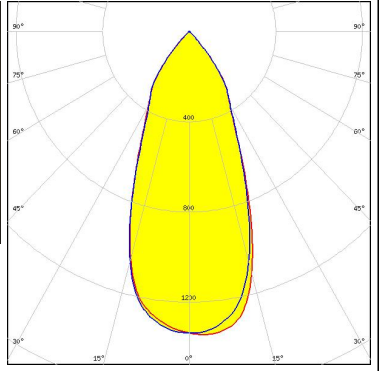
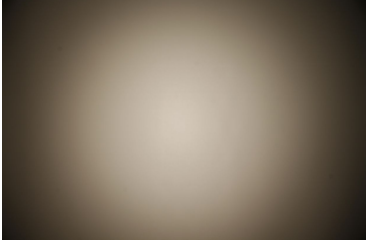
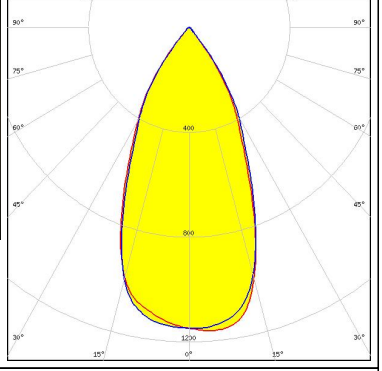
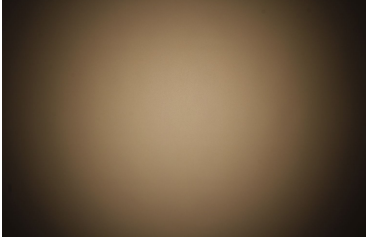
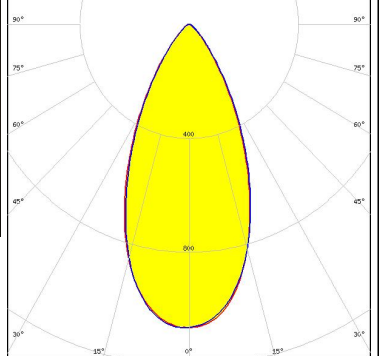

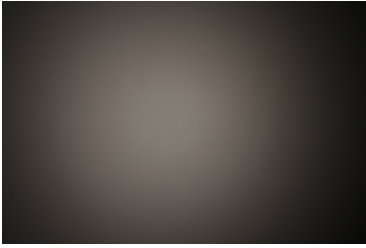
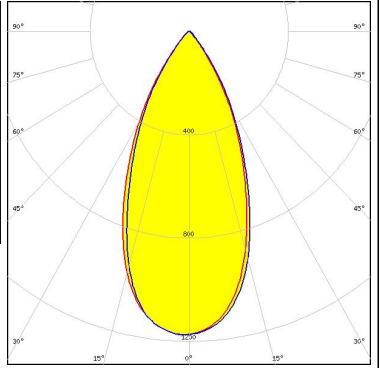
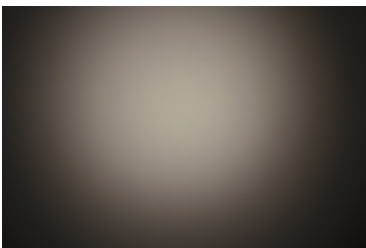
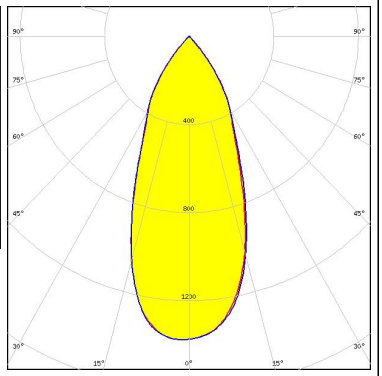

OPTICAL RESULTS (MEASURED):

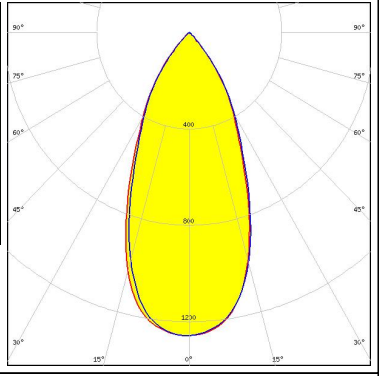
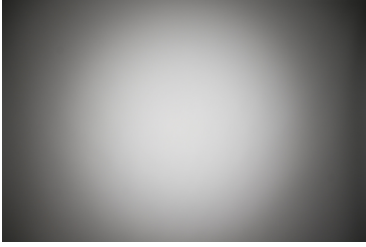
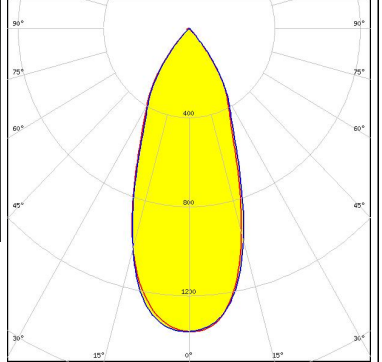
<p>LUMINUS</p> <p>LED CxM-9 (13.5x13.5) FWHM / FWTM 49.0° / 79.0° Efficiency 83 % Peak intensity 1.1 cd/lm LEDs/each optic 1 Light colour White</p> <p>Required components: C13083_PF-SOCKET C12479_MIRELLA-DL</p>		
<p>LUMINUS</p> <p>LED CxM-9 (13.5x13.5) FWHM / FWTM 44.0° / 82.0° Efficiency 88 % Peak intensity 1.3 cd/lm LEDs/each optic 1 Light colour White</p> <p>Required components: C13083_PF-SOCKET</p>		
<p>LUMINUS</p> <p>LED CxM-9 (13.5x13.5) FWHM / FWTM 48.0° / 78.0° Efficiency 83 % Peak intensity 1.2 cd/lm LEDs/each optic 1 Light colour White</p> <p>Required components: C13083_PF-SOCKET C13333_MIRELLA-CL</p>		
<p>LUMINUS</p> <p>LED CxM-9 (13.5x13.5) FWHM / FWTM 48.0° / 83.0° Efficiency 80 % Peak intensity 1.1 cd/lm LEDs/each optic 1 Light colour White</p> <p>Required components: C13083_PF-SOCKET C13723_MIRELLA-RZL</p>		

OPTICAL RESULTS (MEASURED):

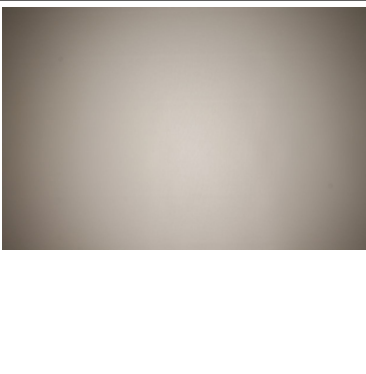
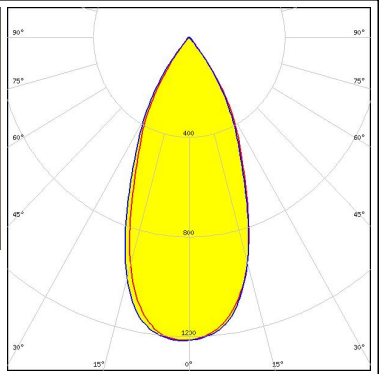
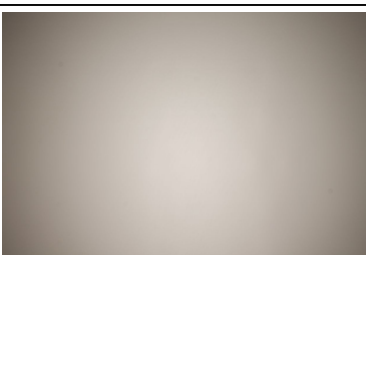
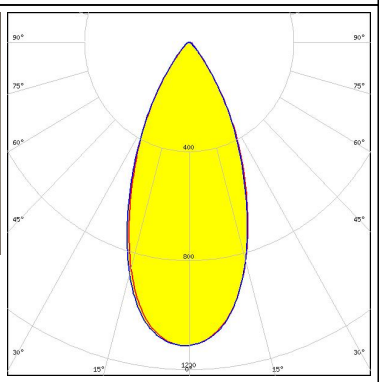
<p>NICHIA</p> <p>LED COB L-Type (LES 11)</p> <p>FWHM / FWTM 46.0° / 77.0°</p> <p>Efficiency 80 %</p> <p>Peak intensity 1.2 cd/lm</p> <p>LEDs/each optic 1</p> <p>Light colour White</p> <p>Required components: C12479_MIRELLA-DL IDEAL: 50-2100NC +50-2100MR</p>		
<p>NICHIA</p> <p>LED COB L-Type (LES 11)</p> <p>FWHM / FWTM 43.0° / 80.0°</p> <p>Efficiency 86 %</p> <p>Peak intensity 1.4 cd/lm</p> <p>LEDs/each optic 1</p> <p>Light colour White</p> <p>Required components: IDEAL: 50-2100NC +50-2100MR</p>		
<p>NICHIA</p> <p>LED COB L-Type (LES 11)</p> <p>FWHM / FWTM 46.0° / 82.0°</p> <p>Efficiency 84 %</p> <p>Peak intensity 1.3 cd/lm</p> <p>LEDs/each optic 1</p> <p>Light colour White</p> <p>Required components: C14037_PF-NSX-SOCKET</p>		
<p>NICHIA</p> <p>LED COB L-Type (LES 11)</p> <p>FWHM / FWTM 41.0° / 79.0°</p> <p>Efficiency 81 %</p> <p>Peak intensity 1.4 cd/lm</p> <p>LEDs/each optic 1</p> <p>Light colour White</p> <p>Required components: C13709_PF-SOCKET-VERO13-18 Bender Wirth: 438 Typ L1</p>		

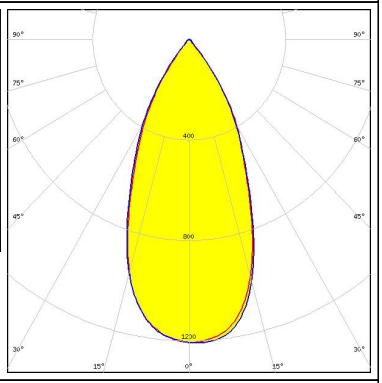
OPTICAL RESULTS (MEASURED):

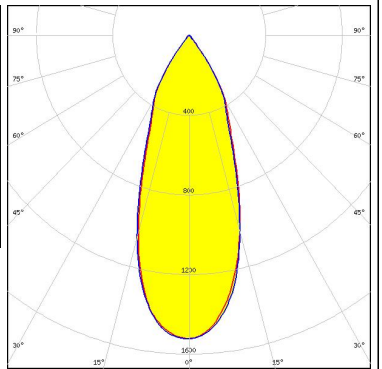
<p>NICHIA</p> <p>LED COB L-Type (LES 11)</p> <p>FWHM / FWTM 45.0° / 75.0°</p> <p>Efficiency 77 %</p> <p>Peak intensity 1.2 cd/lm</p> <p>LEDs/each optic 1</p> <p>Light colour White</p> <p>Required components: C13709_PF-SOCKET-VERO13-18 C13333_MIRELLA-CL Bender Wirth: 438 Typ L1</p>		
<p>NICHIA</p> <p>LED COB L-Type (LES 11)</p> <p>FWHM / FWTM 46.0° / 78.0°</p> <p>Efficiency 75 %</p> <p>Peak intensity 1.1 cd/lm</p> <p>LEDs/each optic 1</p> <p>Light colour White</p> <p>Required components: C13709_PF-SOCKET-VERO13-18 C12479_MIRELLA-DL Bender Wirth: 438 Typ L1</p>		
<p>NICHIA</p> <p>LED COB L-Type (LES 11)</p> <p>FWHM / FWTM 47.0° / 77.0°</p> <p>Efficiency 81 %</p> <p>Peak intensity 1.2 cd/lm</p> <p>LEDs/each optic 1</p> <p>Light colour White</p> <p>Required components: C13333_MIRELLA-CL IDEAL: 50-2100NC +50-2100MR</p>		
<p>NICHIA</p> <p>LED COB L-Type (LES 9)</p> <p>FWHM / FWTM 38.0° / 73.0°</p> <p>Efficiency 81 %</p> <p>Peak intensity 1.5 cd/lm</p> <p>LEDs/each optic 1</p> <p>Light colour White</p> <p>Required components: C13333_MIRELLA-CL IDEAL: 50-2100NC +50-2100MR</p>		

OPTICAL RESULTS (MEASURED):

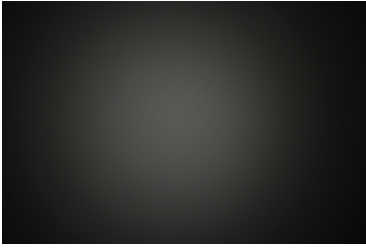
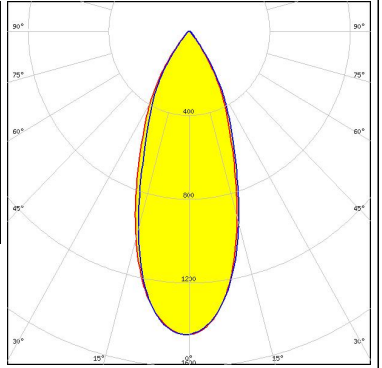
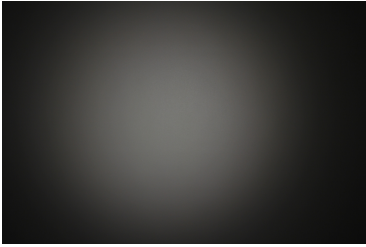
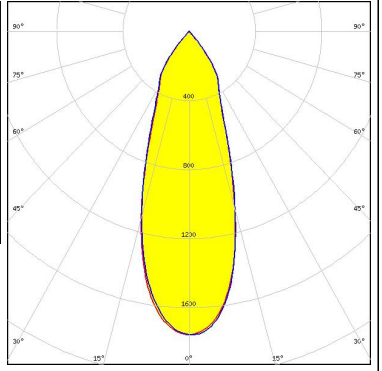
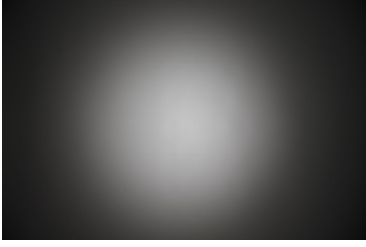
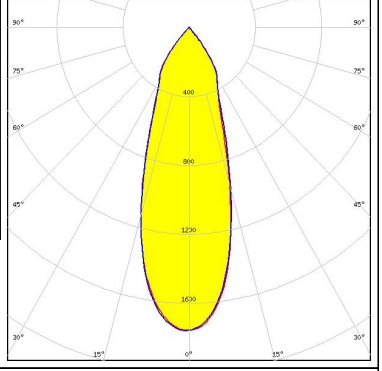
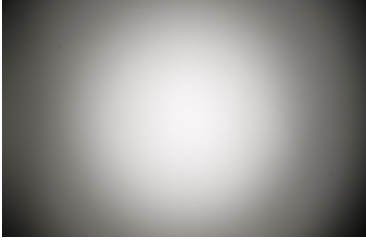
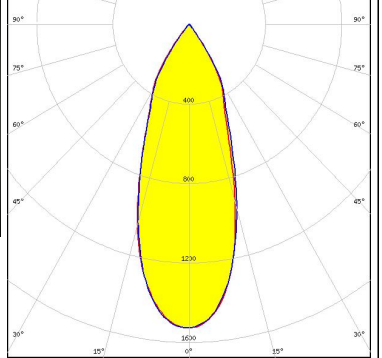
<p>NICHIA</p> <p>LED COB L-Type (LES 9)</p> <p>FWHM / FWTM 39.0° / 73.0°</p> <p>Efficiency 80 %</p> <p>Peak intensity 1.4 cd/m</p> <p>LEDs/each optic 1</p> <p>Light colour White</p> <p>Required components: C12479_MIRELLA-DL IDEAL: 50-2100NC +50-2100MR</p>		
<p>NICHIA</p> <p>LED COB L-Type (LES 9)</p> <p>FWHM / FWTM 35.0° / 77.0°</p> <p>Efficiency 87 %</p> <p>Peak intensity 1.8 cd/m</p> <p>LEDs/each optic 1</p> <p>Light colour White</p> <p>Required components: IDEAL: 50-2100NC +50-2100MR</p>		
<p>NICHIA</p> <p>LED COB L-Type (LES 9)</p> <p>FWHM / FWTM 34.0° / 76.0°</p> <p>Efficiency 84 %</p> <p>Peak intensity 1.8 cd/m</p> <p>LEDs/each optic 1</p> <p>Light colour White</p> <p>Required components: C13709_PF-SOCKET-VERO13-18 Bender Wirth: 438 Typ L1</p>		
<p>NICHIA</p> <p>LED COB L-Type (LES 9)</p> <p>FWHM / FWTM 37.0° / 73.0°</p> <p>Efficiency 79 %</p> <p>Peak intensity 1.5 cd/m</p> <p>LEDs/each optic 1</p> <p>Light colour White</p> <p>Required components: C13709_PF-SOCKET-VERO13-18 C13333_MIRELLA-CL Bender Wirth: 438 Typ L1</p>		



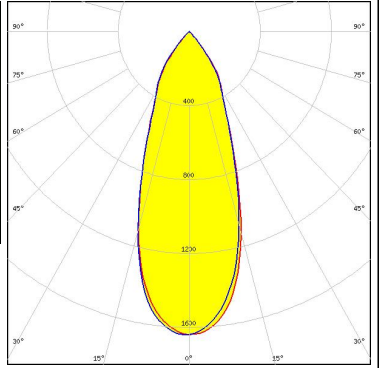
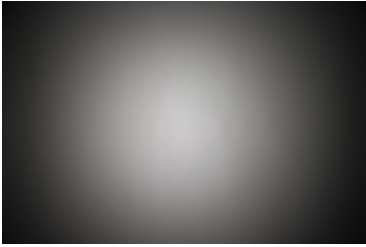
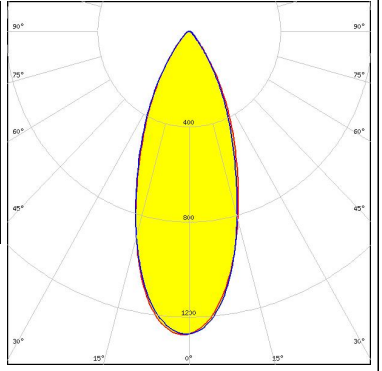
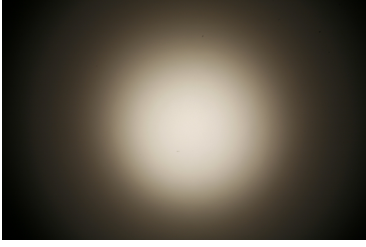
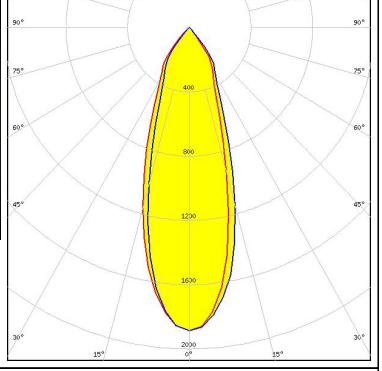
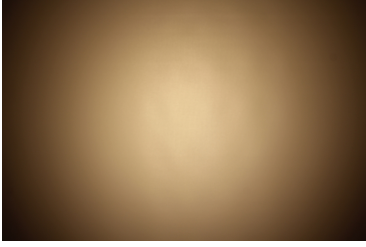

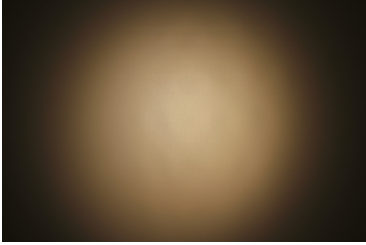
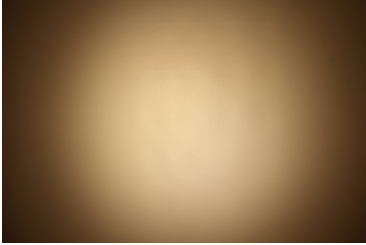
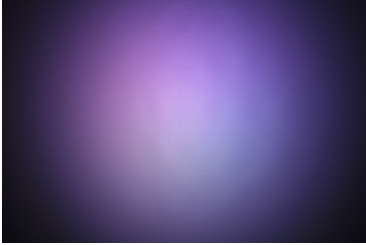

OPTICAL RESULTS (MEASURED):

<p>NICHIA</p> <p>LED COB L-Type (LES 9)</p> <p>FWHM / FWTM 38.0° / 78.0°</p> <p>Efficiency 86 %</p> <p>Peak intensity 1.6 cd/m</p> <p>LEDs/each optic 1</p> <p>Light colour White</p> <p>Required components: C14037_PF-NSX-SOCKET</p>		
<p>NICHIA</p> <p>LED COB L-Type (LES 9)</p> <p>FWHM / FWTM 40.0° / 75.0°</p> <p>Efficiency 76 %</p> <p>Peak intensity 1.3 cd/m</p> <p>LEDs/each optic 1</p> <p>Light colour White</p> <p>Required components: C13709_PF-SOCKET-VERO13-18 C12479_MIRELLA-DL Bender Wirth: 438 Typ L1</p>		
<p>NICHIA</p> <p>LED NSCxL036A</p> <p>FWHM / FWTM 34.0° / 76.0°</p> <p>Efficiency 85 %</p> <p>Peak intensity 1.9 cd/m</p> <p>LEDs/each optic 1</p> <p>Light colour White</p> <p>Required components: C14037_PF-NSX-SOCKET</p>		
<p>OSRAM Opto Semiconductors</p> <p>LED Duris S10</p> <p>FWHM / FWTM 45.0° / 82.0°</p> <p>Efficiency 80 %</p> <p>Peak intensity 1.3 cd/m</p> <p>LEDs/each optic 1</p> <p>Light colour White</p> <p>Required components: C13083_PF-SOCKET C13723_MIRELLA-RZL</p>		

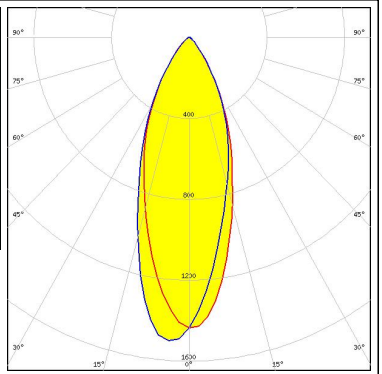
OPTICAL RESULTS (MEASURED):

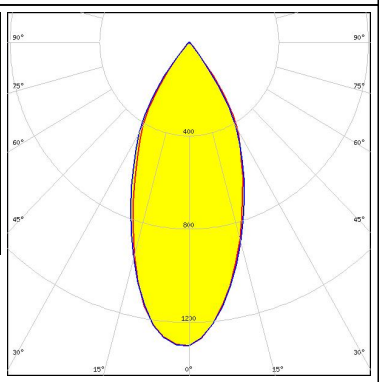
<p>OSRAM Opto Semiconductors</p> <p>LED Duris S10 FWHM / FWTM 45.0° / 81.0° Efficiency 79 % Peak intensity 1.3 cd/lm LEDs/each optic 1 Light colour White</p> <p>Required components: C13083_PF-SOCKET C12479_MIRELLA-DL</p>	
<p>OSRAM Opto Semiconductors</p> <p>LED Duris S10 FWHM / FWTM 38.0° / 82.0° Efficiency 87 % Peak intensity 1.7 cd/lm LEDs/each optic 1 Light colour White</p> <p>Required components: C13083_PF-SOCKET</p>	
<p>OSRAM Opto Semiconductors</p> <p>LED Duris S10 FWHM / FWTM 43.0° Efficiency % LEDs/each optic 1 Light colour White</p> <p>Required components: C13083_PF-SOCKET C13333_MIRELLA-CL</p>	
<p>OSRAM Opto Semiconductors</p> <p>LED OSTAR Stage (S2WP) FWHM / FWTM 36.0° / 78.0° Efficiency 83 % Peak intensity 1.6 cd/lm LEDs/each optic 1 Light colour White</p> <p>Required components: C13083_PF-SOCKET C13723_MIRELLA-RZL</p>	

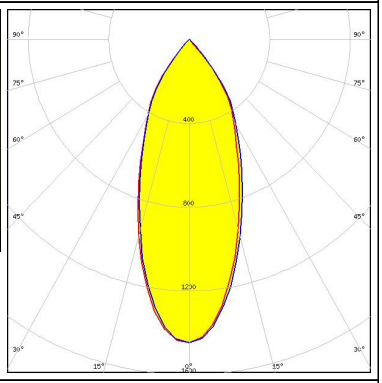
OPTICAL RESULTS (MEASURED):

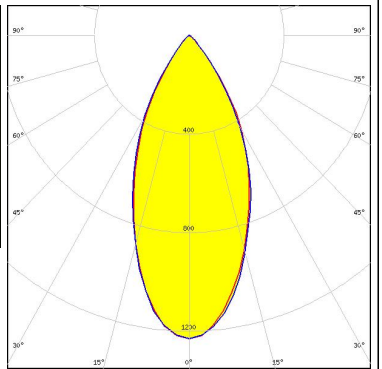
<p>OSRAM Opto Semiconductors</p> <p>LED Ostar-SMT RGB</p> <p>FWHM / FWTM 37.0° / 77.0°</p> <p>Efficiency 81 %</p> <p>Peak intensity 1.5 cd/m</p> <p>LEDs/each optic 1</p> <p>Light colour White</p> <p>Required components: C13083_PF-SOCKET C13723_MIRELLA-RZL</p>		
<p>SEOUL SEOUL SEMICONDUCTOR</p> <p>LED ZC4/6</p> <p>FWHM / FWTM 46.0° / 78.0°</p> <p>Efficiency 80 %</p> <p>Peak intensity 1.3 cd/m</p> <p>LEDs/each optic 1</p> <p>Light colour White</p> <p>Required components: C13083_PF-SOCKET C13333_MIRELLA-CL</p>		
<p>SEOUL SEOUL SEMICONDUCTOR</p> <p>LED ZC4/6</p> <p>FWHM / FWTM 42.0° / 82.0°</p> <p>Efficiency 86 %</p> <p>Peak intensity 1.4 cd/m</p> <p>LEDs/each optic 1</p> <p>Light colour White</p> <p>Required components: C13083_PF-SOCKET</p>		
<p>SEOUL SEOUL SEMICONDUCTOR</p> <p>LED ZC4/6</p> <p>FWHM / FWTM 48.0° / 80.0°</p> <p>Efficiency 81 %</p> <p>Peak intensity 1.2 cd/m</p> <p>LEDs/each optic 1</p> <p>Light colour White</p> <p>Required components: C13083_PF-SOCKET C12479_MIRELLA-DL</p>		

OPTICAL RESULTS (MEASURED):

SHARP

LED Mini Zenigata (GW6BM)
 FWHM / FWTM 38.0° / 81.0°
 Efficiency 88 %
 Peak intensity 1.5 cd/lm
 LEDs/each optic 1
 Light colour White
 Required components:
 C13083_PF-SOCKET

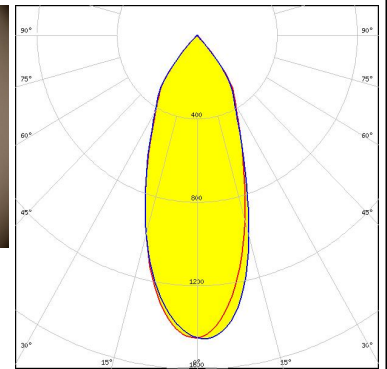
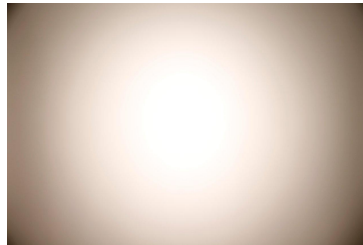

SHARP

LED Mini Zenigata (GW6BM)
 FWHM / FWTM 46.0° / 78.0°
 Efficiency 81 %
 Peak intensity 1.3 cd/lm
 LEDs/each optic 1
 Light colour White
 Required components:
 C13083_PF-SOCKET
 C13333_MIRELLA-CL

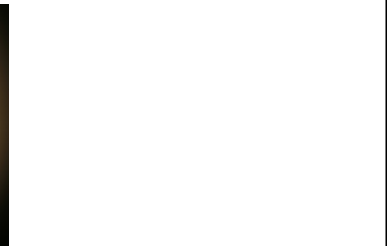
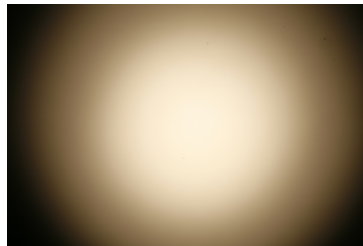

SHARP

LED Mini Zenigata (GW6BM)
 FWHM / FWTM 45.0° / 80.0°
 Efficiency 81 %
 Peak intensity 1.1 cd/lm
 LEDs/each optic 1
 Light colour White
 Required components:
 C13083_PF-SOCKET
 C12479_MIRELLA-DL

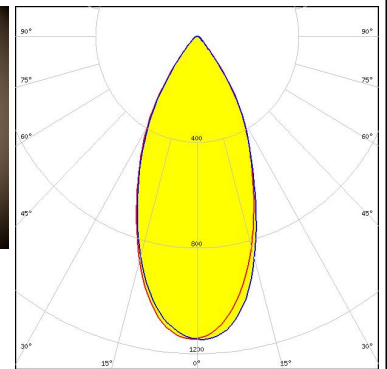
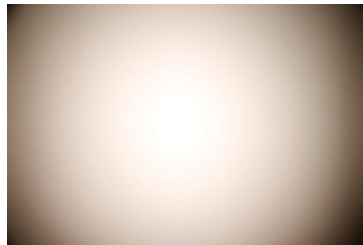



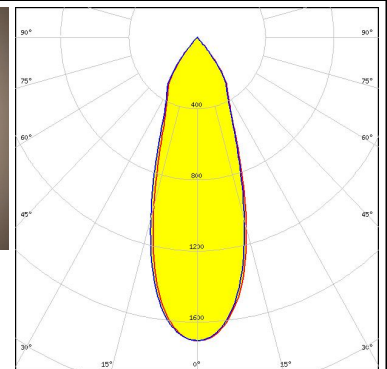
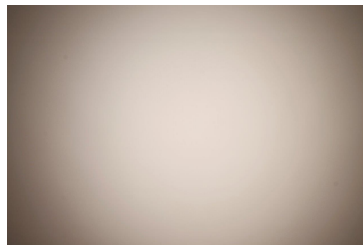

XICATO

LED XTM - 9mm LES
 FWHM / FWTM 35.0° / 76.0°
 Efficiency 83 %
 Peak intensity 1.7 cd/lm
 LEDs/each optic 1
 Light colour White
 Required components:
 C14636_XTM-PF-ADAPTER

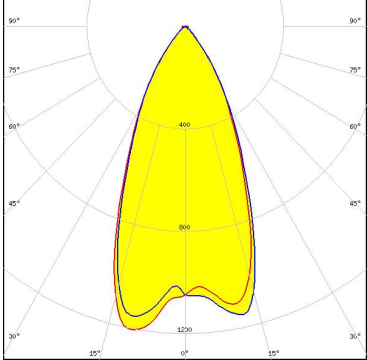

OPTICAL RESULTS (SIMULATED):

		
LED	XM-L RGBW (XMLDCL HD)	
FWHM / FWTM	47.0° / 80.0°	
Efficiency	85 %	
Peak intensity	1.2 cd/lm	
LEDs/each optic	1	
Light colour	RGBW	
Required components:	C13083_PF-SOCKET C13723_MIRELLA-RZL	
<div style="background-color: #ADD8E6; padding: 2px;">Protective plate, glass</div>		
		
LED	LUXEON CoB Compact	
FWHM / FWTM	40.0° / 78.0°	
Efficiency	82 %	
Peak intensity	1.5 cd/lm	
LEDs/each optic	1	
Light colour	White	
Required components:	C13761_PF-SOCKET-CXA15 C12479_MIRELLA-DL	
		
LED	LUXEON CoB Compact	
FWHM / FWTM	37.0° / 72.0°	
Efficiency	77 %	
Peak intensity	1.5 cd/lm	
LEDs/each optic	1	
Light colour	White	
Required components:	C13709_PF-SOCKET-VERO13-18 C13333_MIRELLA-CL Bender Wirth: 452 Typ L1	
		
LED	LUXEON CoB Compact	
FWHM / FWTM	25.0° / 72.0°	
Efficiency	85 %	
Peak intensity	2.6 cd/lm	
LEDs/each optic	1	
Light colour	White	
Required components:	C13709_PF-SOCKET-VERO13-18 Bender Wirth: 452 Typ L1	

OPTICAL RESULTS (SIMULATED):

LUMILEDS

LED LUXEON CoB Compact
FWHM / FWTM 41.0° / 78.0°
Efficiency 82 %
Peak intensity 1.5 cd/lm
LEDs/each optic 1
Light colour White
Required components:
C13761_PF-SOCKET-CXA15
C13333_MIRELLA-CL

LUMILEDS

LED LUXEON CoB Compact
FWHM / FWTM 35.0° / 82.0°
Efficiency 88 %
Peak intensity 1.9 cd/lm
LEDs/each optic 1
Light colour White
Required components:
C13761_PF-SOCKET-CXA15

LUMILEDS

LED LUXEON CoB Compact
FWHM / FWTM 32.0° / 71.0°
Efficiency 77 %
Peak intensity 1.6 cd/lm
LEDs/each optic 1
Light colour White
Required components:
C13709_PF-SOCKET-VERO13-18
C12479_MIRELLA-DL
Bender Wirth: 452 Typ L1

LUMILEDS

LED LUXEON K4
FWHM / FWTM 46.0° / 84.0°
Efficiency 88 %
Peak intensity 1.3 cd/lm
LEDs/each optic 1
Light colour White
Required components:
C13761_PF-SOCKET-CXA15

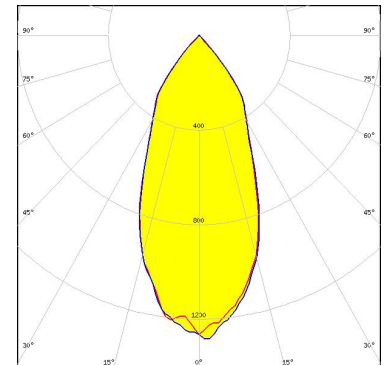

OPTICAL RESULTS (SIMULATED):

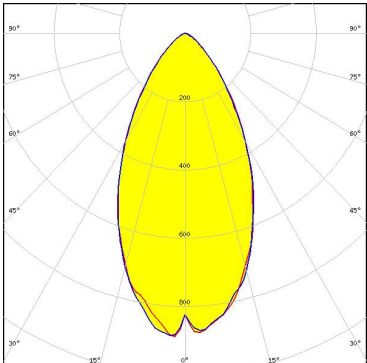
<p>LUMILEDS</p> <p>LED: LUXEON K4 FWHM / FWTM: 54.0° / 98.0° Efficiency: 83 % Peak intensity: 0.9 cd/lm LEDs/each optic: 1 Light colour: White</p> <p>Required components: C13761_PF-SOCKET-CXA15 C12479_MIRELLA-DL</p>	
<p>LUMINUS</p> <p>LED: CxM-14 (19x19) FWHM / FWTM: 51.0° / 81.0° Efficiency: 70 % Peak intensity: 0.9 cd/lm LEDs/each optic: 1 Light colour: White</p> <p>Required components: C13709_PF-SOCKET-VERO13-18 C12479_MIRELLA-DL Bender Wirth: 433 Typ L1</p>	
<p>LUMINUS</p> <p>LED: CxM-14 (19x19) FWHM / FWTM: 49.0° / 72.0° Efficiency: 75 % Peak intensity: 1 cd/lm LEDs/each optic: 1 Light colour: White</p> <p>Required components: C13709_PF-SOCKET-VERO13-18 Bender Wirth: 433 Typ L1</p>	
<p>LUMINUS</p> <p>LED: CxM-9 (13.5x13.5) FWHM / FWTM: 41.0° / 76.0° Efficiency: 76 % Peak intensity: 1.3 cd/lm LEDs/each optic: 1 Light colour: White</p> <p>Required components: C13709_PF-SOCKET-VERO13-18 C12479_MIRELLA-DL Bender Wirth: 434 Typ L1</p>	

OPTICAL RESULTS (SIMULATED):

LUMINUS

LED CxM-9 (13.5x13.5)
FWHM / FWTM 39.0° / 73.0°
Efficiency 78 %
Peak intensity 1.5 cd/lm
LEDs/each optic 1
Light colour White

Required components:

C13709_PF-SOCKET-VERO13-18
C13333_MIRELLA-CL
Bender Wirth: 434 Typ L1

LUMINUS

LED CxM-9 (13.5x13.5)
FWHM / FWTM 36.0° / 77.0°
Efficiency 84 %
Peak intensity 1.7 cd/lm
LEDs/each optic 1
Light colour White

Required components:

C13709_PF-SOCKET-VERO13-18
Bender Wirth: 434 Typ L1

NICHIA

LED COB S-Type (LES 7)
FWHM / FWTM 28.0° / 69.0°
Efficiency 81 %
Peak intensity 2.2 cd/lm
LEDs/each optic 1
Light colour White

Required components:

C13709_PF-SOCKET-VERO13-18
C13333_MIRELLA-CL
Bender Wirth: 452 Typ L1

NICHIA

LED COB S-Type (LES 7)
FWHM / FWTM 25.0° / 72.0°
Efficiency 85 %
Peak intensity 2.6 cd/lm
LEDs/each optic 1
Light colour White

Required components:

C13709_PF-SOCKET-VERO13-18
Bender Wirth: 452 Typ L1

OPTICAL RESULTS (SIMULATED):

<p>NICHIA</p> <p>LED COB S-Type (LES 7)</p> <p>FWHM / FWTM 32.0° / 71.0°</p> <p>Efficiency 77 %</p> <p>Peak intensity 1.6 cd/lm</p> <p>LEDs/each optic 1</p> <p>Light colour White</p> <p>Required components:</p> <p>C13709_PF-SOCKET-VERO13-18</p> <p>C12479_MIRELLA-DL</p> <p>Bender Wirth: 452 Typ L1</p>	
<p>OSRAM Opto Semiconductors</p> <p>LED Soleriq S15</p> <p>FWHM / FWTM 56.0° / 86.0°</p> <p>Efficiency 86 %</p> <p>Peak intensity 1.1 cd/lm</p> <p>LEDs/each optic 1</p> <p>Light colour White</p> <p>Required components:</p> <p>C13709_PF-SOCKET-VERO13-18</p> <p>Bender Wirth: 433 Typ L1</p>	
<p>OSRAM Opto Semiconductors</p> <p>LED Soleriq S9</p> <p>FWHM / FWTM 52.0° / 79.0°</p> <p>Efficiency 85 %</p> <p>Peak intensity 1.1 cd/lm</p> <p>LEDs/each optic 1</p> <p>Light colour White</p> <p>Required components:</p> <p>C13083_PF-SOCKET</p> <p>C13333_MIRELLA-CL</p>	
<p>OSRAM Opto Semiconductors</p> <p>LED Soleriq S9</p> <p>FWHM / FWTM 38.0° / 77.0°</p> <p>Efficiency 88 %</p> <p>Peak intensity 1.7 cd/lm</p> <p>LEDs/each optic 1</p> <p>Light colour White</p> <p>Required components:</p> <p>C13709_PF-SOCKET-VERO13-18</p>	

OPTICAL RESULTS (SIMULATED):

OSRAM

Opto Semiconductors

LED Soleriq S9
 FWHM / FWTM 46.0° / 82.0°
 Efficiency 91 %
 Peak intensity 1.4 cd/lm
 LEDs/each optic 1
 Light colour White
 Required components:
 C13083_PF-SOCKET

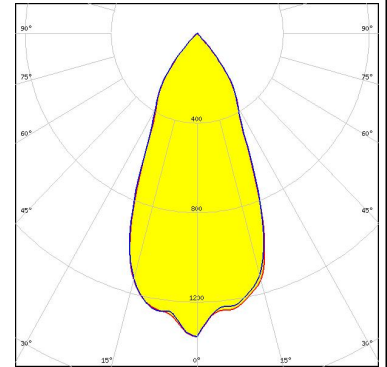

OSRAM

Opto Semiconductors

LED Soleriq S9
 FWHM / FWTM 50.0° / 80.0°
 Efficiency 85 %
 Peak intensity 1.2 cd/lm
 LEDs/each optic 1
 Light colour White
 Required components:
 C13083_PF-SOCKET
 C13723_MIRELLA-RZL

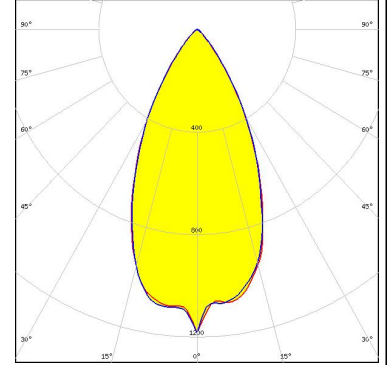

OSRAM

Opto Semiconductors

LED Soleriq S9
 FWHM / FWTM 51.0° / 80.0°
 Efficiency 85 %
 Peak intensity 1.2 cd/lm
 LEDs/each optic 1
 Light colour White
 Required components:
 C13083_PF-SOCKET
 C12479_MIRELLA-DL

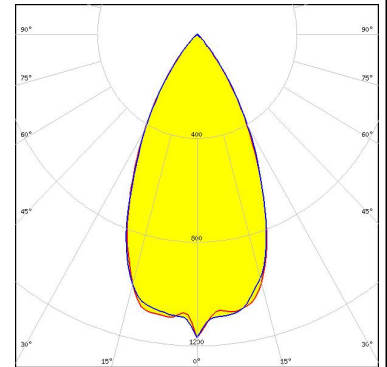

SAMSUNG

LED LC010C
 FWHM / FWTM 32.0° / 74.0°
 Efficiency 87 %
 Peak intensity 2.2 cd/lm
 LEDs/each optic 1
 Light colour White
 Required components:
 C13709_PF-SOCKET-VERO13-18
 Bender Wirth: 479 Typ L1

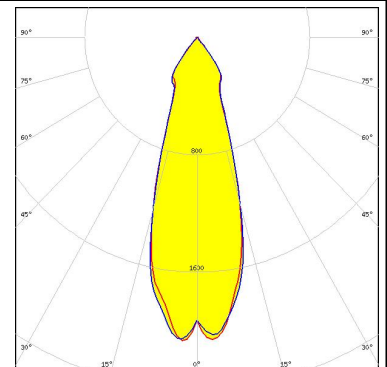

OPTICAL RESULTS (SIMULATED):

SAMSUNG

LED LC020C
 FWHM / FWTM 35.0° / 75.0°
 Efficiency 86 %
 Peak intensity 1.9 cd/lm
 LEDs/each optic 1
 Light colour White
 Required components:
 C13709_PF-SOCKET-VERO13-18
 Bender Wirth: 479 Typ L1

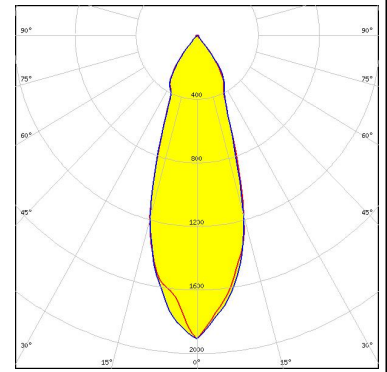

SAMSUNG

LED LC040C
 FWHM / FWTM 42.0° / 79.0°
 Efficiency 84 %
 Peak intensity 1.4 cd/lm
 LEDs/each optic 1
 Light colour White
 Required components:
 C13709_PF-SOCKET-VERO13-18
 Bender Wirth: 480 Typ L1

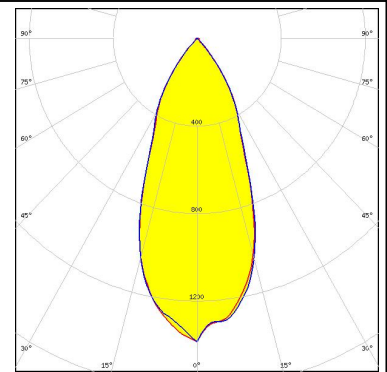

SEOUL SEMICONDUCTOR

LED ZC4/6
 FWHM / FWTM 36.0° / 77.0°
 Efficiency 84 %
 Peak intensity 1.7 cd/lm
 LEDs/each optic 1
 Light colour White
 Required components:
 C13709_PF-SOCKET-VERO13-18
 Bender Wirth: 434 Typ L1



SEOUL SEMICONDUCTOR

LED ZC4/6
 FWHM / FWTM 41.0° / 76.0°
 Efficiency 76 %
 Peak intensity 1.3 cd/lm
 LEDs/each optic 1
 Light colour White
 Required components:
 C13709_PF-SOCKET-VERO13-18
 C12479_MIRELLA-DL
 Bender Wirth: 434 Typ L1

OPTICAL RESULTS (SIMULATED):

 SEOL SEMICONDUCTOR	
LED	ZC4/6
FWHM / FWTM	39.0° / 73.0°
Efficiency	78 %
Peak intensity	1.5 cd/lm
LEDs/each optic	1
Light colour	White
Required components:	
C13709_PF-SOCKET-VERO13-18	
C13333_MIRELLA-CL	
Bender Wirth: 434 Typ L1	

GENERAL INFORMATION:

NOTE: The typical beam angle will be changed by different color, chip size and chip position tolerance. The typical total beam angle is the full angle measured where the luminous intensity is half of the peak value.

Due to use of high power COB's with this product, special attention to proper thermal design is highly recommended. LEDiL has no liability for direct, indirect or consecutive damages arising from the LEDiL products being used outside of the recommended temperature range.

MATERIALS:

As part of our continuous research and improvement processes, and to ensure the best possible quality and availability of our products, LEDiL reserves the right to change material grades without notice.

PRODUCT DATA USER AGREEMENT AND DISCLAIMER:

The measured data in the provided downloadable LEDiL Product Datasheets and Mechanical 2D-Drawings is rounded and provided as reference for planning. LEDiL Oy's optical specifications have been verified by conducting performance testing of the products in accordance with the company's quality system. The reported data are averaged results of multiple measurements with typical variation. LEDiL Oy reserves the right to without prior notification make changes and improvements to its products.

LEDiL Oy assumes neither warranty, nor guarantee nor any other liability of any kind for the contents and correctness of the provided data. The provided data has been generated with highest diligence but the provided data may in reality not represent the complete possible variation range of all intrinsic parameters. Therefore, in certain cases a deviation from the provided data could occur.

LEDiL Oy reserves the right to undertake technical changes of its products without further notification which could lead to changes in the provided data. LEDiL Oy assumes no liability of any kind for the possible deviation from any provided data or any other damage resulting from the usage of the provided data.

The user agrees to this disclaimer and user agreement with the download or usage of the provided files.

LEDiL Oy

Joensuunkatu 13
FI-24240 SALO
Finland

LEDiL Inc.

228 West Page Street
Suite D
Sycamore IL 60178
USA

Ledil Optics Technology (Shenzhen) Co., Ltd.

405 , Block B
Casic Motor Building
Shenzhen 518057
P.R.CHINA

Local sales and technical support

[www.ledil.com/
where_to_buy](http://www.ledil.com/where_to_buy)

Shipping locations

Salo, Finland
Hong Kong, China

Distribution Partners

[www.ledil.com/
where_to_buy](http://www.ledil.com/where_to_buy)