

REVISIONS				
ZONE	REV	DESCRIPTION	DATE	APPROVED

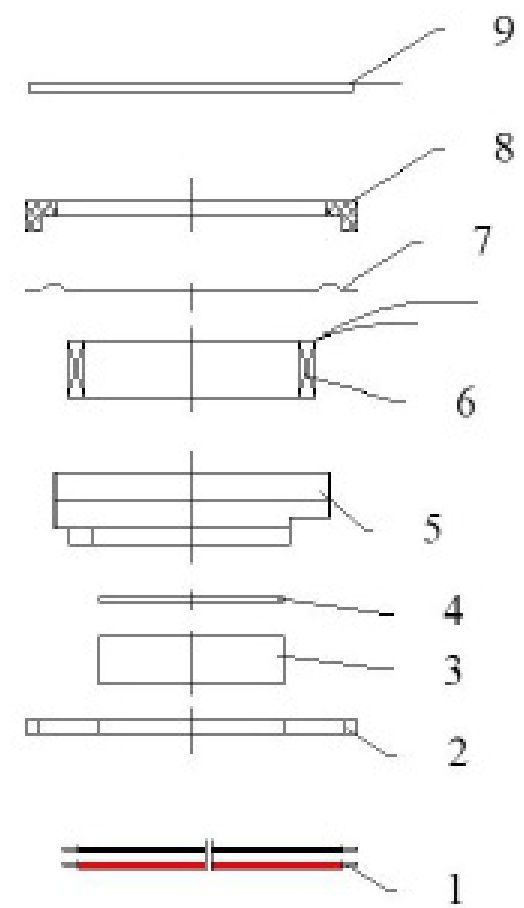

No.	Part Name	Material	Quantity
1	Wire (25mm)	UL1571 / AWG32#	2
2	U Yoke	SPCC	1
3	Magnet	Nd Fe B	1
4	Plate 3	SPCC	1
5	Frame	Black PPA	1
6	Voice Coil	Copper Wire	1
7	Diaphragm	PEEK	1
8	Cap	Black PPA	1
9	Gasket	1511-0.4	1

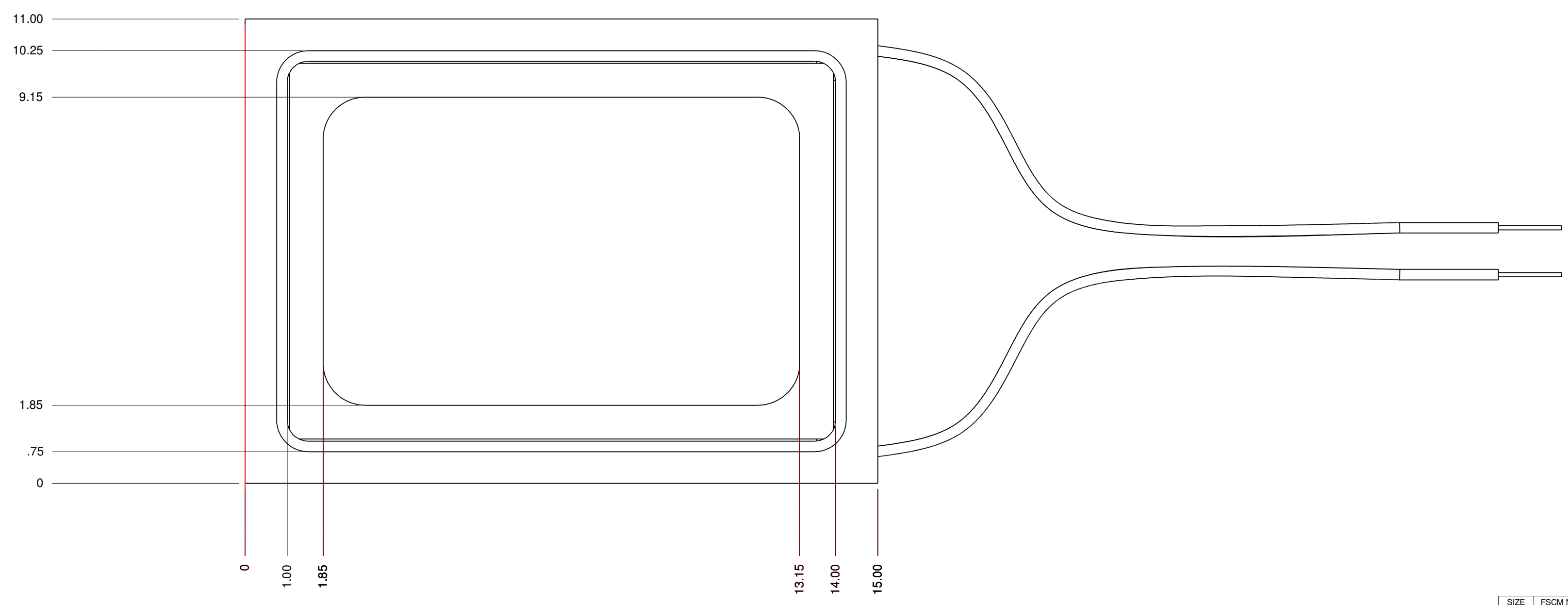
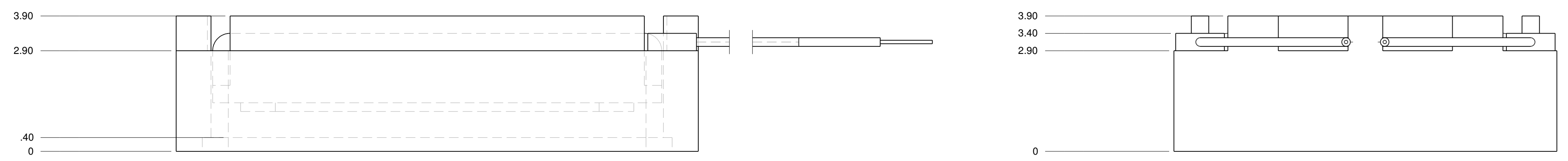
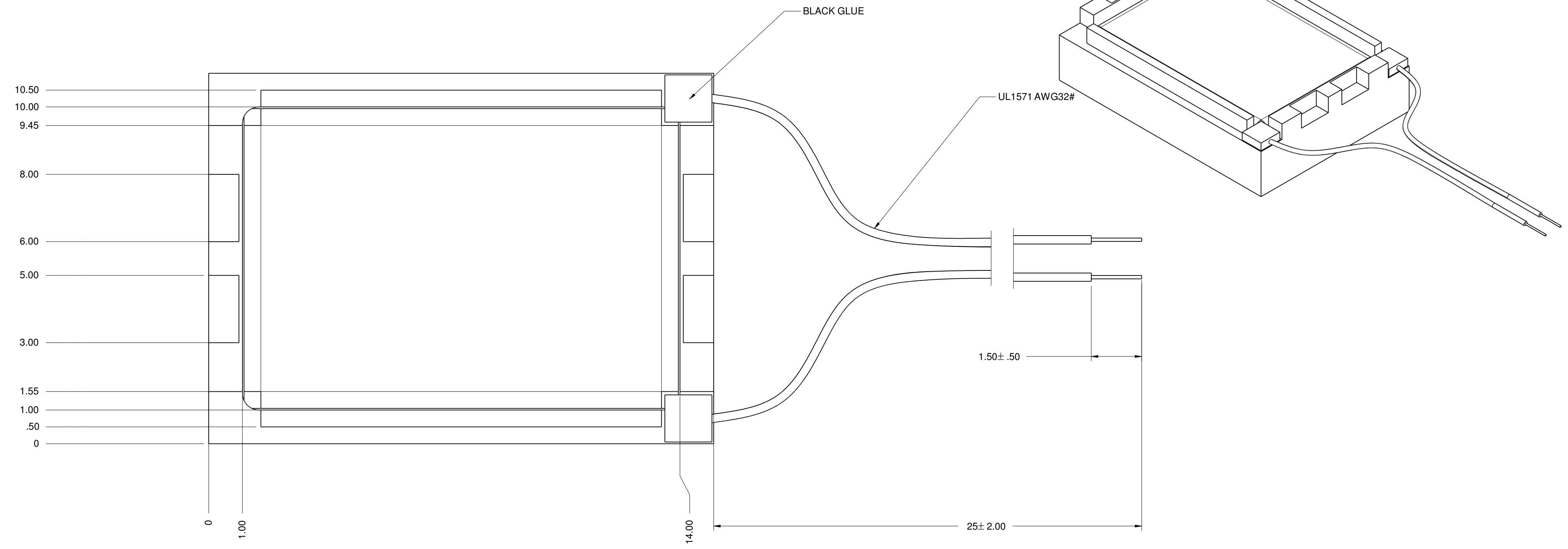

TOLERANCE 0.5MM UNLESS NOTED

SIZE	FSDM NO.	DWG NO.	REV
D		SP-1511L-2	
SCALE	1:1	SHEET	1 OF 1