

LANTRONIX®



PremierWave® XC HSPA+ Intelligent Gateway User Guide

Part Number 900-678
Revision E March 2020

Intellectual Property

© 2020 Lantronix, Inc. All rights reserved. No part of the contents of this publication may be transmitted or reproduced in any form or by any means without the written permission of Lantronix.

Lantronix and *PremierWave* are registered trademarks of Lantronix, Inc. in the United States and other countries. *DeviceInstaller* is a trademark of Lantronix, Inc.

Patented: patents.lantronix.com; additional patents pending

Windows and *Internet Explorer* are registered trademarks of Microsoft Corporation. *Mozilla* and *Firefox* are registered trademarks of the Mozilla Foundation. *Chrome* is a trademark of Google Inc. *Safari* is a registered trademark of Apple Inc. *Wi-Fi* is a trademark of Wi-Fi Alliance Corporation. All other trademarks and trade names are the property of their respective holders.

Warranty

For details on the Lantronix warranty policy, please go to our web site at www.lantronix.com/support/warranty.

Contacts

Lantronix, Inc.
7535 Irvine Center Drive
Suite 100
Irvine, CA 92618, USA

Toll Free: 800-526-8766
Phone: 949-453-3990
Fax: 949-453-3995

Technical Support

Online: www.lantronix.com/support

Sales Offices

For a current list of our domestic and international sales offices, go to the Lantronix web site at www.lantronix.com/about/contact.

Disclaimer

All information contained herein is provided “AS IS.” **Lantronix undertakes no obligation to update the information in this publication.** Lantronix does not make, and specifically disclaims, all warranties of any kind (express, implied or otherwise) regarding title, non-infringement, fitness, quality, accuracy, completeness, usefulness, suitability or performance of the information provided herein. Lantronix shall have no liability whatsoever to any user for any damages, losses and causes of action (whether in contract or in tort or otherwise) in connection with the user’s access or usage of any of the information or content contained herein. **The information and specifications contained in this document are subject to change without notice.**

Revision History

Date	Rev.	Comments
October 2016	F	Updated document to firmware release 8.0.0.0R19. Changes include: <ul style="list-style-type: none">◆ Added Modbus, IPv6, and Initial Send content.◆ Updated Flash and SNMP information.◆ Removed Query Port content.
May 2013	A	Initial document for firmware release 7.7.0.0R27.
April 2014	B	Updated document to firmware release 7.8.0.0.
August 2014	C	Updated document to firmware release 7.9.0.0.
February 2017	D	Updated document to firmware release 8.0.0.0. Changes include adding IPv6, TCP Keep Alive, IKEv2, log verbosity, cellular modem IO, and cellular network traffic information.
March 2020	E	Updated with new default password and label.

Table of Contents

Intellectual Property	2
Warranty	2
Contacts	2
Disclaimer	2
Revision History	3
Table of Contents	4
List of Figures	11
List of Tables	12
1: Using This Guide	15
Purpose and Audience	15
Summary of Chapters	15
Additional Documentation	16
2: Introduction	17
Key Features	17
Applications	18
Protocol Support	18
Troubleshooting Capabilities	19
Configuration Methods	19
Addresses and Port Numbers	19
Hardware Address	19
IP Address	20
Port Numbers	20
Product Information Label	20
3: Installation of the PremierWave XC HSPA+ Device	21
Package Contents	21
User-Supplied Items	21
Hardware Components	22
Front/Top Panel	22
Back Panel	26
Installing the PremierWave XC HSPA+ Unit Device	26

4: Device Discovery and Quick Setup	29
Accessing the PremierWave XC HSPA+ Device Using UPnP	29
Accessing the PremierWave XC HSPA+ Device Using DeviceInstaller	30
Device Detail Summary	31
5: Configuration Using Web Manager	33
Accessing Web Manager	33
Device Status Page	34
Web Manager Components	35
Navigating Web Manager	36
6: Network Settings	39
Network 1 Status	39
Network 1 (eth0) Interface Settings	39
To Configure Network 1 Interface Settings	41
Network 1 (eth0) Link Settings	42
To Configure Network 1 Link Settings	42
Network 1 (eth0) QoS	42
To Configure Network 1 QoS Settings	43
Network 1 (eth0) Failover	44
To Configure Network 1 Failover Settings	44
Network 2 Status	45
Network 2 (Cellular “wwan0”) Interface Settings	45
To Configure Network 2 Interface Settings	46
Network 2 (Cellular “wwan0”) Link Settings	46
To Configure Network 2 Link Settings	46
Network 2 (Cellular “wwan0”) QoS	47
To Configure Network 2 QoS Settings	48
Gateway	48
Status	48
WAN	48
WAN MAC Address Filters	49
To Configure Gateway WAN Settings	49
Port Forwarding	49
To Configure Gateway Port Forwarding Settings	50
Static Routes	50
To Configure Gateway Static Route Settings	51
DHCP Server	51
To Configure Gateway DHCP Server Settings	52
Static Lease Listing	52
Routing Protocols	52
To Configure Gateway Routing Protocol Settings	53

Virtual IP _____	53
To Configure Gateway Virtual IP _____	54
DDNS _____	54
To Configure Gateway WAN Settings _____	55
VPN _____	55
To Configure VPN Settings _____	57
GRE Settings _____	57
To Configure Tunnel Serial Settings _____	58
7: Cellular	59
To Configure Cellular Settings _____	59
Typical Cellular Error (errcodes) _____	60
8: Input/Output Ports	61
Relay Output _____	61
To Configure Relay Settings _____	61
Digital Input _____	62
To Configure Digital Input Settings _____	62
9: Action Settings	63
Alarms and Reports _____	63
Actions _____	63
To Configure Action Settings _____	64
Python _____	65
IDE _____	65
Applications _____	66
To Configure Application Settings _____	67
10: Line and Tunnel Settings	68
Line Statistics _____	68
Line Settings _____	68
To Configure Line Settings _____	68
To Configure Line Command Mode _____	70
Tunnel Statistics _____	71
To View Tunnel Statistics _____	71
Tunnel Settings _____	71
Serial Settings _____	71
To Configure Tunnel Serial Settings _____	72
Packing Mode _____	72
To Configure Tunnel Packing Mode Settings _____	73
Accept Mode _____	73
To Configure Tunnel Accept Mode Settings _____	76

Connect Mode _____	76
Connecting Multiple Hosts _____	78
Host List Promotion _____	79
Disconnect Mode _____	79
To Configure Tunnel Disconnect Mode Settings _____	79
Modem Emulation _____	80
To Configure Tunnel Modem Emulation Settings _____	81

11: Terminal and Host Settings 82

Terminal Settings _____	82
To Configure the Terminal Network Connection _____	83
To Configure the Terminal Line Connection _____	83
Host Configuration _____	83
To Configure Host Settings _____	84

12: Network Services 85

DNS Settings _____	85
To View or Configure DNS Settings: _____	85
FTP Settings _____	86
To Configure FTP Settings _____	86
Syslog Settings _____	86
To View or Configure Syslog Settings _____	87
HTTP Settings _____	87
To Configure HTTP Settings _____	88
To Configure HTTP Authentication _____	89
RSS Settings _____	89
To Configure RSS Settings _____	90
SNMP Settings _____	90
To Configure SNMP Settings _____	90
Discovery _____	91
To Configure Discovery _____	91
SMTP Settings _____	92
To Configure SMTP Settings _____	92
Email Settings _____	92
To View, Configure, and Send Email _____	93

13: SMS Settings 94

Inbound SMS _____	94
Outbound SMS _____	94
To Configure Inbound SMS _____	95
To Configure Outbound SMS _____	95

14: Updating Firmware 96

Obtaining Firmware _____	96
Loading New Firmware through Web Manager _____	96
Loading New Firmware through FTP _____	98

15: Security Settings 99

Public Key Infrastructure _____	99
TLS (SSL) _____	99
Digital Certificates _____	100
Trusted Authorities _____	100
Obtaining Certificates _____	100
Self-Signed Certificates _____	100
Certificate Formats _____	100
OpenSSL _____	101
SSH Settings _____	101
SSH Server Host Keys _____	101
SSH Client Known Hosts _____	102
SSH Server Authorized Users _____	102
SSH Client Users _____	103
To Configure SSH Settings _____	104
SSL Settings _____	105
Create a New Credential _____	105
To Create a New Credential _____	105
Upload Certificate _____	106
Certificate and Key Generation _____	106
To Configure an Existing SSL Credential _____	107
Trusted Authorities _____	108

16: Maintenance and Diagnostics Settings 109

Filesystem Settings _____	109
Statistics _____	109
To View Statistics _____	109
File Display _____	109
To Display Files _____	110
File Modification _____	110
File Transfer _____	110
To Transfer or Modify Filesystem Files _____	111
Protocol Stack Settings _____	111
IP Settings _____	111
To Configure IP Protocol Stack Settings _____	112
ICMP Settings _____	112
To Configure ICMP Protocol Stack Settings _____	112

To View ICMP Protocol Stack Settings _____	112
ARP Settings _____	113
To Configure ARP Network Stack Settings _____	113
Diagnostics _____	114
Hardware _____	114
To View Hardware Information _____	114
IP Sockets _____	114
To View the List of IP Sockets _____	114
Ping _____	114
To Ping a Remote Host _____	115
Traceroute _____	115
To Perform a Traceroute _____	115
Log _____	116
To Configure the Diagnostic Log Output _____	116
Memory _____	116
To View Memory Usage _____	116
Processes _____	117
To View Process Information _____	117
Threads _____	117
To View Thread Information _____	117
Clock _____	118
To Specify Clock Setting Method _____	118
System Settings _____	119
To Reboot or Restore Factory Defaults _____	119

17: Management Interface Settings 120

Command Line Interface Settings _____	120
Basic CLI Settings _____	120
To View and Configure Basic CLI Settings _____	120
Telnet Settings _____	120
To Configure Telnet CLI Settings _____	121
SSH CLI Settings _____	121
To Configure SSH Settings _____	121
XML Settings _____	122
XML: Export Configuration _____	122
To Export Configuration in XML Format _____	123
XML: Export Status _____	123
To Export in XML Format _____	123
XML: Import Configuration _____	124
To Import Configuration in XML Format _____	124

18: Branding the PremierWave XC HSPA+ Device 125

Web Manager Customization _____	125
---------------------------------	-----

Short and Long Name Customization _____	126
To Customize Short or Long Names _____	126

Appendix A: Technical Specifications **127**

Network _____	127
Cellular _____	127
Ethernet _____	127
Serial Interface _____	127
Serial Connector _____	127
USB Interface _____	127
USB Connector _____	128
I/O Interface _____	128
Input _____	128
Output _____	128
I/O Connectors _____	128
LED Indicators _____	128
Routing/Gateway _____	128
Protocol Support _____	129
Event Triggers and Actions _____	129
Security _____	129
Management _____	129
Software _____	129
Power _____	130
Environmental _____	130
Dimensions _____	130

Appendix B: Compliance **131**

Appendix C: Lantronix Technical Support **134**

Appendix D: Binary to Hexadecimal Conversions **135**

Converting Binary to Hexadecimal _____	135
Conversion Table _____	135
Scientific Calculator _____	135

List of Figures

Figure 2-1 PremierWave Unit Product Label	20
Figure 3-1 PremierWave XC HSPA+ Unit	22
Figure 3-5 PremierWave XC HSPA+ Male DB9 DTE Serial Ports	24
Figure 3-6 PremierWave XC HSPA+ Pinout Configuration for RS-232	24
Figure 3-7 PremierWave XC HSPA+ Pinout Configuration for Full Duplex RS-422/485 (4-wire)	25
Figure 3-8 PremierWave XC HSPA+ Pinout Configuration for Half Duplex RS-422/485 (2-wire)	25
Figure 3-11 PremierWave XC HSPA+ Bottom/Back Panel View	26
Figure 3-13 SIM Card Insertion	27
Figure 3-14 PremierWave XC HSPA+ Unit Dimensions in Inches (in)	28
Figure 5-1 Device Status Page	34
Figure 5-2 Components of the Web Manager Page	35
Figure 14-1 Uploading New Firmware	97
Figure D-2 Windows Scientific Calculator	136
Figure D-3 Hexadecimal Values in the Scientific Calculator	136

List of Tables

Table 3-2 PremierWave XC HSPA+ LEDs and Descriptions	22
Table 3-3 Fault Conditions Indicated by Blink Patterns	23
Table 3-4 Cellular Signal Strength Indicator	23
Table 3-9 Left Ethernet LED	25
Table 3-10 Right Ethernet LED	25
Table 3-12 PremierWave XC HSPA+ Connections (Side)	26
Table 5-3 Web Manager Pages	36
Table 6-1 Network Interface Settings	39
Table 6-2 Network 1 (eth0) Link Settings	42
Table 6-3 Network 1 (eth0) QoS Settings	43
Table 6-4 Adding or Deleting Network 1 (eth0) QoS Settings	43
Table 6-5 Network 1 (eth0) Failover Settings	44
Table 6-6 Network 2 (wwan0) Interface Settings	45
Table 6-7 Network 2 (wlan0) Link Settings	46
Table 6-8 Network 2 (wwan0) QoS Settings	47
Table 6-9 Adding or Deleting Network 2 (wwan0) QoS Settings	47
Table 6-10 WAN Configuration	48
Table 6-11 Adding a New MAC Address Filters	49
Table 6-12 Port Forwarding Rules List	50
Table 6-13 Adding a New Port Forwarding Rule	50
Table 6-14 Static Route Setting Routes	50
Table 6-15 Adding a New Static Route	51
Table 6-16 DHCP Settings	51
Table 6-17 Static Lease Listing	52
Table 6-18 Add a Static Lease	52
Table 6-19 Routing Protocol Settings	53
Table 6-20 Virtual IP Settings	53
Table 6-21 Adding a Virtual IP	54
Table 6-22 DDNS Configuration	54
Table 6-23 VPN Configuration	55
Table 6-24 GRE Settings	57
Table 8-1 Relay Output Settings	61
Table 8-2 Digital Input Settings	62
Table 9-1 Action Settings	63
Table 9-2 Script Settings	66

Table 10-1 Line Configuration Settings	69
Table 10-2 Line Command Mode Settings	70
Table 10-3 Tunnel Serial Settings	71
Table 10-4 Tunnel Packing Mode Settings	72
Table 10-5 Tunnel Accept Mode Settings	74
Table 10-6 Tunnel Connect Mode Settings	76
Table 10-7 Tunnel Disconnect Mode Settings	79
Table 10-8 Tunnel Modem Emulation Settings	80
Table 11-1 Terminal on Network and Line Settings	82
Table 11-2 Host Configuration	83
Table 12-1 DNS Settings	85
Table 12-2 FTP Settings	86
Table 12-3 Syslog Settings	86
Table 12-4 HTTP Settings	87
Table 12-5 HTTP Authentication Settings	89
Table 12-6 RSS Settings	89
Table 12-7 SNMP Settings	90
Table 12-8 Discovery Settings	91
Table 12-9 SMTP Settings	92
Table 12-10 Email Configuration	92
Table 13-1 Inbound SMS Settings	94
Table 13-2 Adding a New SMS Settings	94
Table 13-3 Outbound SMS Settings	94
Table 15-1 SSH Server Host Keys	101
Table 15-2 SSH Client Known Hosts	102
Table 15-3 SSH Server Authorized Users	103
Table 15-4 SSH Client Users	103
Table 15-5 Create New Keys	104
Table 15-6 Create a New Credentials	105
Table 15-7 Upload Certificate Settings	106
Table 15-8 Certificate and Key Generation Settings	106
Table 15-9 Trusted Authority Settings	108
Table 16-1 File Statistics	109
Table 16-2 File Display Settings	109
Table 16-3 File Modification Settings	110
Table 16-4 File Transfer Settings	110
Table 16-5 IP Protocol Stack Settings	111
Table 16-6 ICMP Protocol Stack Settings	112

Table 16-7 ARP Protocol Stack Settings _____	113
Table 16-8 Ping Settings _____	114
Table 16-9 Traceroute Settings _____	115
Table 16-10 Log Settings _____	116
Table 16-11 Clock Settings _____	118
Table 16-12 System Settings _____	119
Table 17-1 CLI Configuration Settings _____	120
Table 17-2 Telnet Settings _____	121
Table 17-3 SSH Settings _____	121
Table 17-4 XML Exporting Configuration _____	122
Table 17-5 Exporting Status _____	123
Table 17-6 Import Configuration from Filesystem Settings _____	124
Table 18-1 Short and Long Name Settings _____	126
Table D-1 Binary to Hexadecimal Conversion _____	135

1: Using This Guide

Purpose and Audience

This guide provides the information needed to configure, use, and update the Lantronix® PremierWave® XC HSPA+ intelligent gateway. It is intended for software developers and system integrators who are installing this product into their designs.

Summary of Chapters

The remaining chapters in this guide include:

Chapter	Description
2: Introduction	Main features of the product and the protocols it supports. Includes technical specifications.
3: Installation of the PremierWave XC HSPA+ Device	Instructions for installing the PremierWave XC HSPA+ device.
4: Device Discovery and Quick Setup	Instructions for viewing the device and configuration using UPnP and the DeviceInstaller™ utility.
5: Configuration Using Web Manager	Instructions for accessing Web Manager and using it to configure settings for the device.
6: Network Settings	Instructions for configuring network settings.
7: Cellular	Instructions for configuring cellular settings.
8: Input/Output Ports	Instructions for configuring relay output and digital input settings.
9: Action Settings	Instructions for configuring alarm settings.
10: Line and Tunnel Settings	Instructions for configuring line and tunnel settings.
11: Terminal and Host Settings	Instructions for configuring terminal and host settings.
12: Network Services	Instructions for configuring DNS, FTP, HTTP and Syslog settings.
13: SMS Settings	Instructions for configuring SMS Settings.
14: Updating Firmware	Instructions for obtaining and updating the latest firmware for the device.
15: Security Settings	Instructions for configuring SSL security settings.
16: Maintenance and Diagnostics Settings	Instructions to view statistics, files, and diagnose problems.
17: Management Interface Settings	Instructions for configuring CLI and XML settings.
18: Branding the PremierWave XC HSPA+ Device	Instructions on how to brand your device.
Appendix A: Technical Specifications	Technical specifications for the device.
Appendix B: Compliance	Lantronix compliance information.
Appendix C: Lantronix Technical Support	Instructions for contacting Lantronix Technical Support.
Appendix D: Binary to Hexadecimal Conversions	Instructions for converting binary values to hexadecimals.

Additional Documentation

Visit the Lantronix Web site at www.lantronix.com/support/documentation for the latest documentation and the following additional documentation.

Document	Description
PremierWave XC HSPA+ Intelligent Gateway Command Reference	Instructions for accessing Command Mode (the command line interface) using a Telnet connection, SSH connection or through the port. Detailed information about the commands. Also provides details for XML configuration and status.
PremierWave XC HSPA+ Intelligent Gateway Quick Start	Instructions for getting the PremierWave XC HSPA+ device up and running.
DeviceInstaller™ Utility Online Help	Instructions for using the Windows® operating system-based utility to locate the intelligent gateway and to view its current settings.
Com Port Redirector Quick Start and Online Help	Instructions for using the Windows operating system-based utility to create virtual com ports.
Secure Com Port Redirector User Guide	Instructions for using the Windows operating system-based utility to create secure virtual com ports.

2: Introduction

The PremierWave XC HSPA+ intelligent gateway is an industrial grade GSM/GPRS 3.5G cellular solution that enables customers to quickly connect their machines and assets for out-of-the-box Internet access, remote monitoring, control and cloud platform connectivity.

With highly configurable and easy to use software offering enterprise level security, the PremierWave XC HSPA+ intelligent gateway makes it possible to combine multiple application use cases in a compact, ruggedized platform.

Key Features

Communicate with Industrial Equipment and Machines Remotely and Securely

- ◆ Setup secure communication channels with serial and Ethernet based devices

Cellular Routing

- ◆ Ethernet to Cellular Routing
- ◆ NAT, Port Forwarding, Firewall

WAN Failover and Failback Support

- ◆ Support mission critical applications with a secondary path to the internet via cellular WAN

Device Server Application Suite

- ◆ Control and monitor serial port based devices over the IP network
- ◆ Supporting multiple virtual serial connections
- ◆ Multiple connection modes and configuration options to enable transparent tunneling of hundreds of serial protocols

Event Triggers and Actions

- ◆ Multiple configurable actions for pre-defined event triggers
- ◆ Simple PLC operations and system state change notifications
- ◆ Actions include sending email, posting to a Web Service, sending SMS, triggering relay output

Enterprise Class Management Features

- ◆ Powerful and flexible Web browser based UI
- ◆ CLI for advanced administration tasks
- ◆ XML for batch configuration and status

Advanced SMS Features

- ◆ SMS Control and Status Features
- ◆ SMS Actions on Event Triggers
- ◆ Number White-listing by application

Global Cellular Coverage

- ◆ Penta-band UMTS/HSPA+ (800/850/900/1900/2100 MHz)
- ◆ Quad Band GSM/GPRS/EDGE (850/900/1800/1900 MHz)

Industrial Grade

- ◆ **Temperature Range:** Operating temperature at -40°C to +70°C. Storage temperature at -40°C to +85°C

Wide Voltage Range: 9 - 30VDC input voltage through locking barrel connector

Flexible Connectivity Options

- ◆ **Serial Ports:** Two RS-232/422/485 ports with support from 300 to 921 kbps data rate
- ◆ **Ethernet port:** Auto-Sensing and Auto MDIX (cross-over) 10/100
- ◆ **Digital Inputs:** Two configurable inputs suitable for TTL input levels and tolerant up to 30VDC input voltage
- ◆ **Relay Output:** One independently isolated mechanical form-C relay
- ◆ **USB:** One USB host port

Applications

The PremierWave XC HSPA+ intelligent gateway is very suitable for these application scenarios:

Remote Monitoring/Control

- ◆ Data Display Services/Digital Signage
- ◆ Oil and Gas Exploration
- ◆ Smart Metering
- ◆ Street Lighting
- ◆ Gas Station Pump Control
- ◆ Irrigation Pump Control
- ◆ Industrial Controls and Instrumentation
- ◆ Fixed Telemetry
- ◆ Railway Maintenance
- ◆ Food and Beverage Temperature Control
- ◆ Security and Access Control Panels
- ◆ In-home Monitoring

Out-of-Band Connectivity

- ◆ Point-of-Sale/Kiosks
- ◆ Call Boxes

Business Continuity Solutions

- ◆ Primary WAN Link
- ◆ Secondary WAN Failover/Failback

Protocol Support

The PremierWave XC HSPA+ intelligent gateway contains a full-featured IP networking stack:

- ◆ ARP, HTTP, HTTPS, SMTP AUTH, SNMP v1/v2c/v3, UDP/IP, TCP/IP, SSH, SSL, TLS, RSS, UPnP, ICMP, BOOTP, DHCP, Auto IP, Telnet, SNTP, FTP, FTPS, DNS, TFTP, XML and Syslog for network communications and management
- ◆ FTP and HTTP/HTTPS web server for firmware upgrades and uploading/downloading files
- ◆ TCP/IP, UDP/IP, Telnet, SSH, SSL, TCP AES and UDP AES for command/response based data acquisition application or alarm triggered connection
- ◆ HTTP/HTTPS web based monitoring of input readings, chart and data logging
- ◆ SMTP AUTH, SMS, HTTP/HTTPS Post, FTP/FTPS Put and SNMP Traps for alarm-triggered notification
- ◆ SNTP and Cellular Network for device clock synchronization

Troubleshooting Capabilities

The PremierWave XC HSPA+ device server offers a comprehensive diagnostic toolset that lets you troubleshoot problems quickly and easily. Available from the CLI or Web Manager, the diagnostic tools let you:

- ◆ View critical hardware, memory, buffer pool, IP socket information and routing table
- ◆ Perform ping and traceroute operations
- ◆ Conduct forward or reverse DNS lookup operations
- ◆ View all processes currently running on the PremierWave XC HSPA+ intelligent gateway including CPU utilization
- ◆ View system log messages

Configuration Methods

After installation, the PremierWave XC HSPA+ unit requires configuration. For the unit to operate correctly on a network, it must have a unique IP address on the network. There are four basic methods for logging into the PremierWave XC HSPA+ intelligent gateway and assigning IP addresses and other configurable settings:

- ◆ **Web Manager:** View and configure all settings easily through a web browser using the Lantronix Web Manager. (See [Configuration Using Web Manager on page 33](#).)
- ◆ **DeviceInstaller:** Configure the IP address and related settings and view current settings on the PremierWave XC HSPA+ intelligent gateway using a Graphical User Interface (GUI) on a PC attached to a network. You will need the latest version of the Lantronix® DeviceInstaller™ utility. (See [Accessing the PremierWave XC HSPA+ Device Using DeviceInstaller on page 30](#).)
- ◆ **Command Mode:** There are a few methods for accessing Command Mode (CLI): making a Telnet connection, or connecting a PC or other host running a terminal emulation program to the unit's serial port. (See the *PremierWave XC HSPA+ Intelligent Gateway Command Reference* for instructions and available commands.)
- ◆ **XML:** The PremierWave XC HSPA+ intelligent gateway supports XML-based configuration and setup records that make device configuration transparent to users and administrators. XML is easily editable with a standard text or XML editor. (See the *PremierWave XC HSPA+ Intelligent Gateway Command Reference* for instructions and commands).

Addresses and Port Numbers

Hardware Address

The hardware address is also referred to as the Ethernet address, physical address, or MAC address. The first three bytes of the Ethernet address are fixed and identify the unit as a Lantronix product. The fourth, fifth, and sixth bytes are unique numbers assigned to each unit. Sample hardware address:

- ◆ 00-80-A3-14-1B-18
- ◆ 00:80:A3:14:1B:18

IP Address

Every device connected to an IP network must have a unique IPv4 address. This address references the specific unit.

Port Numbers

Every TCP connection and every UDP datagram is defined by a destination and source IP address, and a destination and source port number. For example, a Telnet server commonly uses TCP port number 23.

The following is a list of the default server port numbers running on the PremierWave XC HSPA+ intelligent gateway:

- ◆ TCP Port 22: SSH Server (Command Mode configuration)
- ◆ TCP Port 23: Telnet Server (Command Mode configuration)
- ◆ TCP Port 80: HTTP (Web Manager Configuration)
- ◆ TCP Port 21: FTP
- ◆ UDP Port 30718: LDP (Lantronix Discovery Protocol) port
- ◆ TCP/UDP Port 10001: Tunnel 1 (see note below)
- ◆ UDP Port 1900 and TCP Port 30179: UPnP

Note: Additional TCP/UDP ports and tunnels will be available, depending on the product type. The default numbering of each additional TCP/UDP port and corresponding tunnel will increase sequentially (i.e., TCP/UDP Port 1000X: Tunnel X).

Product Information Label

The product information label on the unit contains the following information about the specific unit:

- ◆ Part Number
- ◆ International Mobile Equipment Identity (IMEI) Number
- ◆ Serial Number (MAC Address)
- ◆ Country of Origin
- ◆ Product Revision
- ◆ Manufacturing Date Code
- ◆ Device ID

Note: The hardware address on the label is also the product serial number. The hardware address on the label is the address for the Ethernet (eth0) interface.

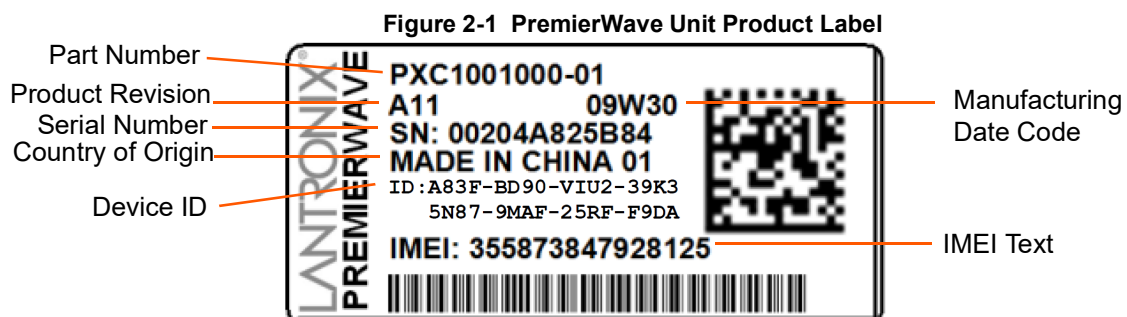

3: Installation of the PremierWave XC HSPA+ Device

This chapter describes how to install the PremierWave XC HSPA+ intelligent gateway. It contains the following sections:

- ◆ [Package Contents](#)
- ◆ [User-Supplied Items](#)
- ◆ [Hardware Components](#)
- ◆ [Installing the PremierWave XC HSPA+ Unit Device](#)

Package Contents

The PremierWave XC HSPA+ package includes the following items:

- ◆ PremierWave XC HSPA+ intelligent gateway
- ◆ RJ-45 Ethernet Straight CAT5 cable
- ◆ Two External antennas with an SMA connector
- ◆ One Power Supply 12 VDC with international adapters (PXC2102H2-01-S) or One DC Power Cable (PXC2101H2-01-02-S)
- ◆ Mounting components (DIN rail mounting adapter, cover plates, and rubber feet)
- ◆ *PremierWave XC HSPA+ Quick Start Guide*

User-Supplied Items

To complete your installation, you need the following items:

- ◆ RS-232/422/485 serial devices that require network connectivity
- ◆ Devices and sensors that require network connectivity.
 - A serial cable, as listed below, for each serial device. One end of the cable must have a female DB9 connector for the serial port.
 - A null modem cable to connect the serial port to another DTE device.
 - A straight-through modem cable to connect the serial port to a DCE device.
- ◆ An available connection to your Ethernet network and an Ethernet cable.
- ◆ A working AC power outlet if the unit will be powered from an AC outlet using the included 12 VDC power supply
- ◆ If the unit uses the DC power cable (PXC2102H2-01-02-S) then a DC power supply with terminal blocks or screw terminals
- ◆ A network SIM card (and data services) from a service provider

Hardware Components

Front/Top Panel

Figure 3-1 shows the top panel view of the PremierWave unit. Table 3-2, Table 3-3, and Table 3-4 list and explain the behavior of the LEDs on the top panel.

LED Indicators: 1 Power LED, 2 Serial Activity LEDs, 1 USB LED, 1 Cellular Status LED, 5 Signal Strength LEDs (two of which are dual-colored), 1 Diagnostic LED, and 2 Ethernet LEDs (on the RJ45 port).

Figure 3-1 PremierWave XC HSPA+ Unit



Table 3-2 PremierWave XC HSPA+ LEDs and Descriptions

LED	Description
Power	<ul style="list-style-type: none"> ◆ GREEN - displays a solid light when power is properly supplied ◆ OFF - no power supplied
Cellular (Cell) Status	<ul style="list-style-type: none"> ◆ GREEN - displays solid when there is a connection to the packet domain on the cellular network (e.g., a data or GPRS/UMTS/HSPA connection) ◆ AMBER - displays solid when there is a connection to the cellular network (e.g., a GSM connection) ◆ OFF - indicates WWAN (cellular) interface is inactive or disabled
Serial 1	<ul style="list-style-type: none"> ◆ GREEN - flashes when Serial port 2 is transmitting data ◆ AMBER - flashes when Serial port 2 is receiving data ◆ OFF - when no data is being transmitted or received through Serial port 2
Serial 2	<ul style="list-style-type: none"> ◆ GREEN - flashes when Serial port 2 is transmitting data ◆ AMBER - flashes when Serial port 2 is receiving data ◆ OFF - when no data is being transmitted or received through Serial port 2
USB	<ul style="list-style-type: none"> ◆ GREEN - displays a solid light when a USB device is connected to and is functioning properly ◆ OFF - when no USB device is connected
Signal Strength	<ul style="list-style-type: none"> ◆ Indicates cellular signal strength when connection is established (see Table 3-2)

Table 3-3 Fault Conditions Indicated by Blink Patterns

Note: The fault LED blink patterns in this table are listed in order of priority.

Fault Conditions	Blink Pattern
No Ethernet link when eth0 (Ethernet Network) is enabled.	Long, long, short, short, 2 seconds off (pattern repeats)
No IP obtained from Ethernet network when eth0 interface is enabled.	Long, long, short, short, short, 2 seconds off (pattern repeats)
No link (no SIM detected)	Long(pattern repeats)
No cellular link when wwan0 (Cellular Network) is enabled	Long, long, long, long, short, 2 seconds off (pattern repeats)
No IP obtained from cellular networkwhen wwan0 (Cellular Network) is enabled and bridge mode is disabled	Long, long, long, short, short, short, 2 seconds off (pattern repeats)
When the internal device temperature is above operating limit.	Long, short, short, short, 2 seconds off (pattern repeats)
When the internal device temperature is below operating limit.	Short, short, short, short, 2 seconds off (pattern repeats)
Primary power source (barrel connector) is under-volt (below 9 volts).	Long, short, short (pattern repeats)
Secondary power source (terminal) is under-volt (below 9 volts).	Long, short, short, short (pattern repeats)

Table 3-4 Cellular Signal Strength Indicator

Signal Strength	Color & Number of LED Signal Bars
Greater than or equal to -64 dBm	5 Green
Greater than or equal to -85 dBm and less than -64 dBm	4 Green
Greater than or equal to -75 dBm and less than -85 dBm	3 Green
Greater than or equal to -86 dBm and less than -75 dBm	2 Amber
Greater than or equal to -112 dBm and less than -86 dBm	1 Amber
Less than -113 dBm or unmeasurable	All Off

Notes:

- ◆ For [Table 3-3](#) above, a “long” blink is 0.7 seconds of light followed by 0.3 seconds of no light. A “short” blink is a light that is on for only 0.2 seconds and followed by 0.2 seconds of no light.
- ◆ The diagnostic blink patterns reflect the highest priority fault condition. Also, the Diagnostic LED will give an initial, identifying blink pattern to indicate the type of diagnostic information it will display. All power and other non-network related diagnostic patterns, with the exception of Temperature events and No SIM Card events, begin with one long blink. All wired LAN related diagnostics patterns begin with two long blinks. All cellular-related diagnostics patterns begin with four long blinks.

The PremierWave device has two male DB9 serial ports that support RS-232/422/485. [Figure 3-5](#) shows the front view of the device. The default serial port settings are 9600 baud, 8 bits, no parity, 1 stop bit, no flow control.

Figure 3-5 PremierWave XC HSPA+ Male DB9 DTE Serial Ports

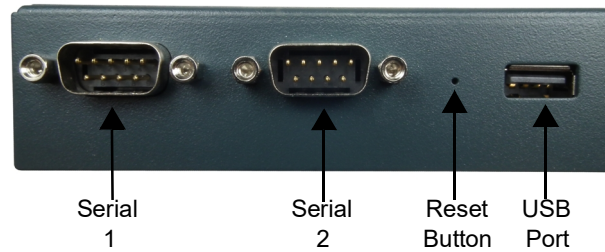

Figure 3-6 PremierWave XC HSPA+ Pinout Configuration for RS-232

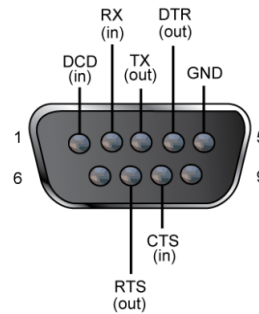

Figure 3-7 PremierWave XC HSPA+ Pinout Configuration for Full Duplex RS-422/485 (4-wire)

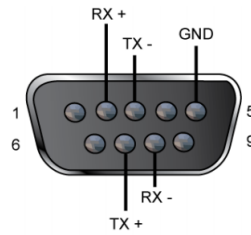
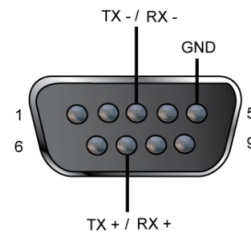

Figure 3-8 PremierWave XC HSPA+ Pinout Configuration for Half Duplex RS-422/485 (2-wire)



Ethernet LEDs

The Ethernet port (see [Figure 3-11](#)) has two LEDs that indicate the status of the connection as described in the [Table 3-9](#) and [Table 3-10](#) below:

Table 3-9 Left Ethernet LED

Color/Status	Solid Light	Blinking Pattern
Green	100 Mbps Link	100 Mbps Activity
Amber	10 Mbps Link	10 Mbps Activity

Table 3-10 Right Ethernet LED

Color/Status	Solid Light
Green	Full Duplex
OFF	Half Duplex

The Ethernet port can connect to an Ethernet (10 Mbps) or Fast Ethernet (100 Mbps) network.

Reset Button

You can reset the PremierWave XC HSPA+ intelligent gateway to factory defaults, including clearing the network settings. The IP address, gateway, and netmask are set to 00s. To reset the unit to factory defaults, perform the following steps.

1. Place the end of a paper clip or similar object into the reset opening (see [Figure 3-5](#)) and press and hold down micro switch during a power cycle for 10-15 seconds.

- Remove the paper clip to release the button. The unit will continue the boot process restoring it back to the original factory default settings.

Back Panel

On the PremierWave device is a Power Connector and RJ-45 Ethernet port as shown in [Figure 3-11](#).

Figure 3-11 PremierWave XC HSPA+ Bottom/Back Panel View

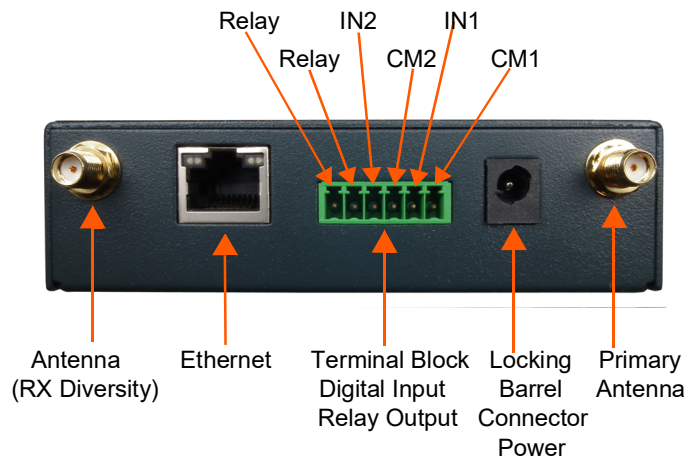

Table 3-12 PremierWave XC HSPA+ Connections (Side)

Connector	Description		
Relay Output	Outputs Support 1A 24V		
Inputs	Inputs accept voltage 0 to 30 VDC.		
	ON	Max	30 VDC
		Min	2 VDC
	OFF	Max	0.7 VDC
	Min	0 VDC	

Installing the PremierWave XC HSPA+ Unit Device

Be sure to place or mount the device securely on a flat horizontal or vertical surface. The device comes with brackets for mounting it, for example, on a wall. If using AC power, do not use outlets controlled by a wall switch.

Observe the following guidelines when connecting the devices:

- ◆ The PremierWave unit serial ports support RS-232/422/485.
- ◆ Use a null modem cable to connect the serial port to another DTE device. Use a straight-through (modem) cable to connect the serial port to a DCE device.
- ◆ Connect your RJ-45 Ethernet cable to the RJ-45 port of the unit.
- ◆ The PremierWave device supports a power range of 9 to 30 VDC.

Note: As soon as you plug the device into power, the device powers up automatically, the self-test begins, and LEDs would indicate the device's status

Perform the following steps to install your device:

1. With the power unplugged, insert your SIM card.
2. Connect an RJ-45 Ethernet cable between the unit and your Ethernet network.
3. Connect the antennas to the SMA connectors on the back. Do note that the safe distance due to RF exposure from antenna is 2 cm.

Note: Antennas must be installed prior to powering on the unit. Do not remove or connect the antennas while the unit power is on.

4. Plug the PremierWave XC device into the power outlet by using the power supply that was included in the packaging.

Figure 3-13 SIM Card Insertion

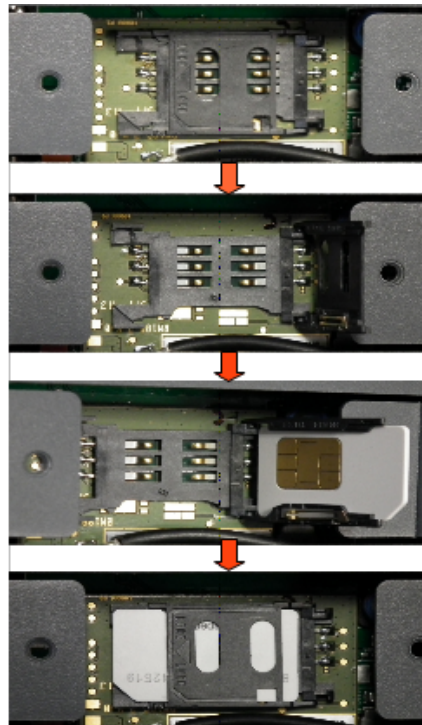
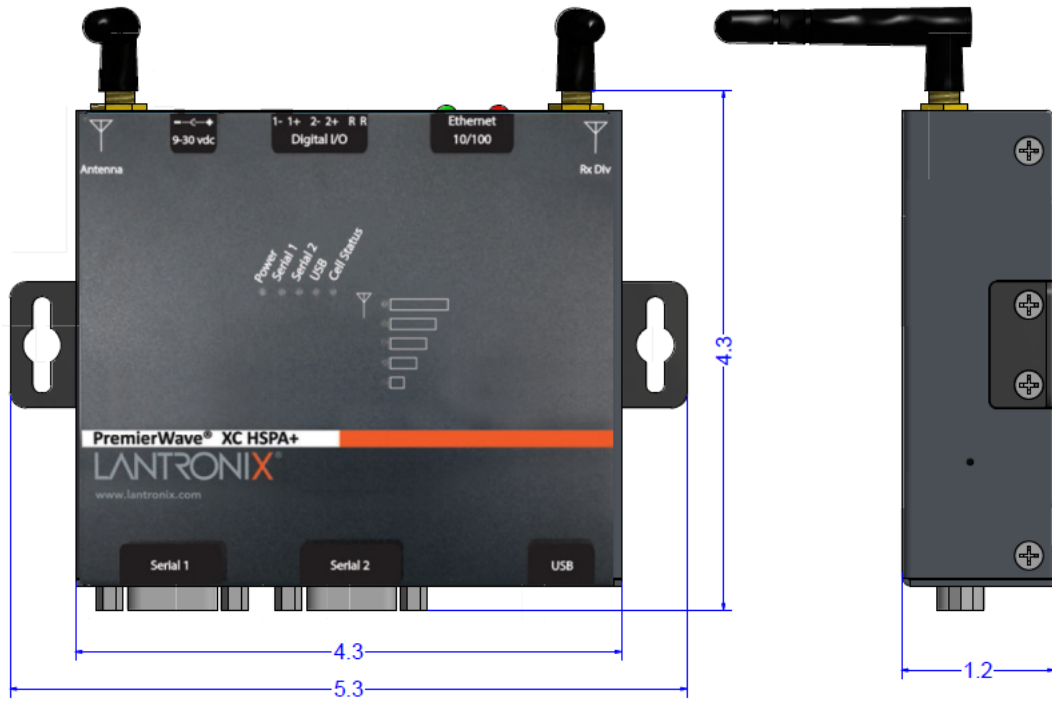

Figure 3-14 PremierWave XC HSPA+ Unit Dimensions in Inches (in)



4: Device Discovery and Quick Setup

Software embedded within the PremierWave XC HSPA+ intelligent gateway enables the device to be easily discovered via the Ethernet network without any knowledge of the IP address or default network configuration of the device.

The two methods supported are:

1. [Accessing the PremierWave XC HSPA+ Device Using UPnP](#)
2. [Accessing the PremierWave XC HSPA+ Device Using DeviceInstaller](#)

The device's factory default username is "**admin**" and factory default password is the last 8 characters of the Device ID (for devices manufactured after January 1, 2020) or "**PASS**" (for all older devices).

Accessing the PremierWave XC HSPA+ Device Using UPnP

This section covers the steps for locating a PremierWave XC HSPA+ unit and viewing its properties and device details using UPnP (Network Discovery). You may also use the DeviceInstaller utility to discover PremierWave XC HSPA+ units. See [Accessing the PremierWave XC HSPA+ Device Using DeviceInstaller on page 30](#).

The PremierWave XC HSPA+ units can be discovered automatically from Microsoft Windows® platforms using UPnP (Network Discovery). UPnP enables devices to be discovered and a refreshed list of devices available under "Network Places" within Windows Explorer as devices come online or go offline.

Using the operations described below, it becomes a "plug and play" mechanism to reach the device's Web UI (Web Manager) and complete the rest of the configuration.

Note: *There is no new software to install as UPnP support is built-into Windows operating systems, however it must be enabled on the Windows PC. Please see notes on enabling UPnP (Network Discovery) on Windows XP and Windows 7 operating systems.*

To search devices on Windows XP operating system:

1. Click **Start->My Network Places**. Lantronix PremierWave XC HSPA+ devices will be listed like other network devices.
2. Double-click your device to view the device web page.

To search devices on Windows 7 operating system:

1. Click **Start->Computer->Network**. Lantronix PremierWave XC HSPA+ devices will be listed like other network devices.
2. Double-click or right click your device and select **View device webpage** to view the device web page.

To view device properties on Windows XP operating system:

1. Click **Start->My Network Places**. Lantronix PremierWave XC HSPA+ devices will be listed like other network devices.
2. Right click your device and select **Properties** to view the device properties.

To search device properties on Windows 7 operating system:

1. Click **Start->Computer->Network**. Lantronix PremierWave XC HSPA+ devices will be listed like other network devices.
2. Right click your device and select **Properties** to view the device properties.

Accessing the PremierWave XC HSPA+ Device Using DeviceInstaller

This section covers the steps for locating a PremierWave XC HSPA+ unit and viewing its properties and device details. The DeviceInstaller application is a free utility program provided by Lantronix that discovers, configures, upgrades and manages Lantronix device servers.

Notes:

- ◆ *For instructions on using the DeviceInstaller utility to configure the IP address and related settings or for more advanced features, see the DeviceInstaller Online Help.*
- ◆ *Auto IP generates a random IP address in the range of 169.254.0.1 to 169.254.255.254, with a netmask of 255.255.0.0, if no BOOTP or DHCP server is found. These addresses are not routable.*
- ◆ *You may also use UPnP to discover PremierWave XC HSPA+ units. See [Accessing the PremierWave XC HSPA+ Device Using UPnP on page 29](#).*
- ◆ *Make note of the MAC address. It may be needed to perform various functions in DeviceInstaller.*

To use the DeviceInstaller utility, first install the latest version from the downloads page on the Lantronix web site www.lantronix.com/downloads.

1. Run the executable to start the installation process and respond to the installation wizard prompts. (If prompted to select an installation type, select **Typical**.)
2. Click **Start -> All Programs -> Lantronix -> DeviceInstaller 4.4 -> DeviceInstaller**.
3. Click **Tools > Enter Global Credentials**. Select **Prompt with a dialog box to login** and click **OK**.
4. When DeviceInstaller starts, it will perform a network device search. To perform another search, click **Search**.
5. Expand the **PremierWave** folder by clicking the **+** symbol next to the folder icon. The list of available Lantronix PremierWave devices appears.
6. Select the PremierWave unit by expanding its entry and clicking on its IP address to view its configuration.
7. On the right page, click the **Device Details** tab. The current PremierWave device configuration appears. This is only a subset of the full configuration; the full configuration may be accessed via Web Manager, CLI or XML.

Device Detail Summary

Note: The settings are display only in this table unless otherwise noted.

Current Settings	Description
Name	Shows the PremierWave XC HSPA+ device name.
DHCP Device Name	Displays one of the names the PremierWave XC HSPA+ unit will send to the DHCP server if it is configured to obtain an address in this manner.
Group	Configurable field. Enter a group to categorize the PremierWave unit. Double-click the field, type in the value, and press Enter to complete. This group name is local to this PC and is not visible on other PCs or laptops using DeviceInstaller.
Comments	Configurable field. Enter comments for the PremierWave unit. Double-click the field, type in the value, and press Enter to complete. This description or comment is local to this PC and is not visible on other PCs or laptops using DeviceInstaller.
Device Family	Shows the device family type as "PremierWave".
Short Name	Shows "premierwave_xc_hspa" by default.
Long Name	Shows "Lantronix PremierWave XC HSPA+" by default.
Type	Shows the device type as "PremierWave XC HSPA+".
ID	Shows the PremierWave ID embedded within the unit.
Hardware Address	Shows the PremierWave hardware (MAC) address.
Firmware Version	Shows the firmware currently installed on the PremierWave unit.
Extended Firmware Version	Provides additional information on the firmware version.
Online Status	Shows the PremierWave unit status as Online , Offline , Unreachable (the PremierWave is on a different subnet), or Busy (the PremierWave is currently performing a task).
IP Address	Shows the PremierWave current IP address. To change the IP address, click the Assign IP button on the DeviceInstaller menu bar.
IPv6 Link Local Address	Shows the current PremierWave IPv6 link local address.
IPv6 Global Address	Shows the current PremierWave IPv6 global address.
IP Address was Obtained	Appears "Dynamically" if the PremierWave device automatically received an IP address (e.g., from DHCP). Appears "Statically" if the IP address was configured manually. If the IP address was assigned dynamically, the following fields appear: <ul style="list-style-type: none"> ◆ Obtain via DHCP with values of True or False. ◆ Obtain via BOOTP with values of True or False.
Subnet Mask	Shows the subnet mask specifying the network segment on which the PremierWave unit resides.
Gateway	Shows the IP address of the router of this network. There is no default.
Interfaces	Shows information about the Ethernet (eth0) and wireless (wlan0) interfaces for your PremierWave unit. Click the + sign beside eth0 or wlan0, and then the Status and Configuration subcategories to view status and configuration information on these interfaces.
Number of Serial Ports	Shows the number of serial ports on unit.
Number of Relay Outputs	Shows the number of relay outputs on the intelligent gateway.

Current Settings	Description
Supports Configurable Pins	Shows False , indicating configurable pins are not available on the PremierWave unit.
Supports Email Triggers	Shows True , indicating email triggers are available on the unit.
Telnet Supported	Indicates whether Telnet is enabled on this PremierWave unit.
Telnet Port	Shows the PremierWave port for Telnet sessions.
Web Port	Shows the PremierWave port for Web Manager configuration (if Web Enabled field is True).
Firmware Upgradeable	Shows True , indicating the PremierWave firmware is upgradeable as newer versions become available.

5: Configuration Using Web Manager

This chapter describes how to configure the PremierWave XC HSPA+ intelligent gateway using Web Manager, the Lantronix browser-based configuration tool. The unit's configuration is stored in non-volatile memory and is retained without power. All changes take effect immediately, unless otherwise noted. It contains the following sections:

- ◆ [Accessing Web Manager](#)
- ◆ [Device Status Page](#)
- ◆ [Web Manager Components](#)
- ◆ [Navigating Web Manager](#)

Accessing Web Manager

Note: You can also access the Web Manager by selecting the Web Configuration tab on the DeviceInstaller application window.

To access Web Manager, perform the following steps:

1. Open a standard web browser. Lantronix supports the latest versions of Internet Explorer, Mozilla Firefox, Safari or Chrome web browsers.
2. Enter the IP address or hostname of the PremierWave XC HSPA+ unit in the address bar. The IP address may have been assigned manually using DeviceInstaller (see the *PremierWave XC HSPA+ Intelligent Gateway Quick Start Guide*) or automatically by DHCP.
3. Enter your username and password. The factory default username is "**admin**" and factory default password is the last 8 characters of the Device ID (for devices manufactured after January 1, 2020) or "**PASS**" (for all older devices).

Device Status Page

The Device Status page is the first to appear after you log into Web Manager. The Device Status page also appears when you click **Status** in Web Manager.

Figure 5-1 Device Status Page

PremierWave[®] XC HSPA+ LANTRONIX[®]

Status [\[Logout\]](#)

Device Status

Product Information		
Product Type:	Lantronix PremierWave XC HSPA+ (premierwave_xc_hspa)	
Firmware Version:	8.0.0.0R13	
Cellular Firmware Version:	03.001 [01.001.24]	
Build Date:	Jan 9 14:33:44 PST 2017	
Serial Number:	0080A39A0170	
Uptime:	5 days 07:09:03	
Current Date/Time:	Sat Jan 06 07:09:06 UTC 2007	
Temperature:	32.0C	
Permanent Config:	Saved	
Alerts		
Alarm (wwan0 link state change)		
Duration:	5 days 07:08:39	
Network Settings		
Name servers		
Primary DNS:	172.19.1.1	
Secondary DNS:	172.19.1.2	
Interface eth0		
Link:	Auto 10/100 Mbps Auto Half/Full (100 Mbps Full)	
MAC Address:	00:80:A3:9A:01:70	
Hostname:	<None>	
MTU:	1500	
IP Address:	172.19.100.51/16 <DHCP>	
Network Mask:	255.255.0.0 <DHCP>	
Default Gateway:	172.19.0.1 <DHCP>	
Domain:	eng.lantronix.com <DHCP>	
IPv6 Global Address:	2001:db80:ac13:d91e:121:dfea:44f4:762/64 <DHCP>	
IPv6 Global Address:	2001:db80:ac13:d91e:280:a3ff:fe9a:170/64 <DHCP>	
IPv6 Link-local Address:	fe80::280:a3ff:fe9a:170/64	
IPv6 Default Gateway:	fe80::6600:f1ff:feb6:586e fe80::20c:29ff:fe5f:dab fe80::225:84ff:fe54:d53c <DHCP>	
IPv6 Domain:	eng.lantronix.com. <DHCP>	
Interface wwan0		
Packet Domain Status:	registered on foreign network (roaming)	
IP Address:	<None>	
Line Settings		
Line 1:	RS232, 9600, None, 8, 1, None	
Line 2:	RS232, 9600, None, 8, 1, None	
Tunneling		
	Connect Mode	Accept Mode
Tunnel 1:	Disabled	Waiting
Tunnel 2:	Disabled	Waiting
VPN		
Status:	Disabled	
IP Address:	<None>	

Copyright © Lantronix, Inc. 2007-2017. All rights reserved.

Web Manager Components

The layout of a typical Web Manager page is below.

Figure 5-2 Components of the Web Manager Page

The screenshot shows the PremierWave XC HSPA+ Web Manager interface. The header includes the product name and LANTRONIX logo. A left menu bar lists various system settings. The main content area displays the configuration for Network 1 (eth0) interface, including options for State, IPv4 State, BOOTP Client, DHCP Client, Priority, IP Address, Default Gateway, Hostname, Domain, DHCP Client ID, Primary DNS, Secondary DNS, MTU, IPv6 State, IPv6 DHCP Client, IPv6 Address, IPv6 Default Gateway, IPv6 Domain, IPv6 Primary DNS, and IPv6 Secondary DNS. A right sidebar contains help text and a Logout button. The footer includes copyright information.

Header: PremierWave XC HSPA+ LANTRONIX

Menu Bar: Status, Action, Applications, Cellular, CLI, Clock, Diagnostics, Digital Input, Discovery, DNS, DDNS, Email, Filesystem, FTP, Gateway, GRE, Host, HTTP, Line, **Network**, Protocol Stack, Relay, RSS, SMS, SMTP, SNMP, SSH, SSL, Syslog, System, Terminal, Tunnel, VPN, XML

Items to configure: Network 1, Network 2, Interface, Link, QoS, Failover, Status, Configuration

Links to subpages: Network 1, Network 2

Logout button: [Logout]

Configuration and/or Status Area: Network 1 (eth0) Interface Configuration

Information and Help Area: This page is used to configure the Network interface on the device. To see the effect of these items after a reboot, view the Status page. State: Enable or Disable the interface. The following items require a reboot to take effect: State, BOOTP Client On/Off, DHCP Client On/Off, Priority, IP Address, DHCP Client ID. If BOOTP or DHCP is turned on, any configured IP Address, Network Mask, Gateway, Hostname, or Domain will be ignored. BOOTP/DHCP will auto-discover and eclipse those configuration items. If both BOOTP and DHCP are turned on, DHCP will run, but not BOOTP. When BOOTP or DHCP fails to discover an IP Address, a new address will automatically be generated using AutoIP. This address will be within the 169.254.x.x space. Each interface can be assigned a Priority from 0-10. Note: Lower priority number means higher preference. IP Address may be entered alone, in CIDR form, or with an explicit mask. 192.168.1.1 (default mask) 192.168.1.1/24 (CIDR) 192.168.1.1 255.255.255.0 (explicit mask) IPv6 Address may be entered alone. IPv6 Address and IPv6 Default Gateway may be entered with scope id. IPv6 DNS entries can also be entered here. Hostname must begin with a letter, continue with letter, number, or hyphen, and must end with a letter or number.

Footer: Copyright © Lantronix, Inc. 2007-2017. All rights reserved.

Web Manager pages have these sections:

The menu bar always appears at the left side of the page regardless of the page shown. The menu bar lists the names of the pages available in the Web Manager. To bring up a page, click it in the menu bar.

The main area of the page has these additional sections:

- ◆ Links near the top of many pages, such as the one in the example above, enable you to link to additional subpages. On some pages, you must also select the item you are configuring, such as a tunnel.
- ◆ In the middle of many pages, you can select or enter new configuration settings. Some pages show status or statistics in this area rather than allow you to enter settings.
- ◆ At the bottom of most pages, the current configuration is displayed. In some cases, you can reset or clear a setting.
- ◆ When a parameter is changed on the page, a **Submit** button will appear. Click on this button to save the change.
- ◆ The information or help area shows information or instructions associated with the page.
- ◆ A **Logout** link is available at the upper right corner of every page. In Chrome or Safari, it is necessary to close out of the browser to completely logout. If necessary, reopen the browser to log back in.
- ◆ The footer appears at the very bottom of the page. It contains copyright information and a link to the Lantronix home page.

Navigating Web Manager

The Web Manager provides an intuitive point-and-click interface. A menu bar on the left side of each page provides links you can click to navigate from one page to another. Some pages are read-only, while others let you change configuration settings.

Note: *There may be times when you must reboot the PremierWave XC HSPA+ device for the new configuration settings to take effect. The chapters that follow indicate when a change requires a reboot. Anytime you reboot the unit, this operation will take some time to complete. Please wait a minimum of 25-30 seconds after rebooting the unit before attempting to make any subsequent connections.*

Table 5-3 Web Manager Pages

Web Manager Page	Description	See Page
Status	Shows product information, network, line, and tunneling settings.	34
Actions	Allows you to view and configure the actions for a specific alarm or report.	63
Applications	Allows you to view and configure Application settings.	66
Cellular	Shows cellular statistics and lets you change the current CLI configuration settings.	59
CLI	Shows Command Line Interface (CLI) statistics and lets you change the current CLI configuration settings.	120
Clock	Allows you to view and configure the current date, time and time zone as it displays in web manager.	118
Diagnostics	Lets you perform various diagnostic procedures.	114
Digital Input	Allows you to view and configure digital input, shows current input status and allows you to scale and modify display of both digital inputs.	65

Web Manager Page (continued)	Description	See Page
Discovery	Allows you to view and modify the configuration and statistics for device discovery.	91
DDNS	Allows you to view and configure DDNS settings.	54
DNS	Shows the current configuration of the DNS subsystem and the DNS cache.	85
Email	Shows email statistics and lets you clear the email log, configure email settings, and send an email.	92
Filesystem	Shows file system statistics and lets you browse the file system to view a file, create a file or directory, upload files using HTTP, copy a file, move a file, or perform TFTP actions.	109
FTP	Shows statistics and lets you change the current configuration for the File Transfer Protocol (FTP) server.	86
Gateway	Shows statistics and lets you change the current configuration for the gateway.	48
GRE	Allows you to view and configure GRE settings.	57
Host	Lets you view and change settings for a host on the network.	83
HTTP	Shows HyperText Transfer Protocol (HTTP) statistics and lets you change the current configuration and authentication settings.	87
Line	Shows statistics and lets you change the current configuration and Command mode settings of a serial line.	68
Network	Shows status and lets you configure the network interface.	39
Protocol Stack	Lets you perform lower level network stack-specific activities.	111
Query Port	Lets you change configuration settings for the query port.	114
Relay	Allows you to view and configure relay output, shows current relay output statuses and allows you to modify display of both relays.	81
RSS	Lets you change current Really Simple Syndication (RSS) settings.	89
SMS	Shows and allows modification to the current configuration of SMS.	94
SMTP	Shows and allows modification of the current configuration of SMTP.	92
SNMP	Shows and allows modification of the current configuration of SNMP.	92
SSH	Lets you change the configuration settings for SSH server host keys, SSH server authorized users, SSH client known hosts, and SSH client users.	101
SSL	Lets you upload an existing certificate or create a new self-signed certificate.	105
Syslog	Lets you specify the severity of events to log and the server and ports to which the syslog should be sent.	86
System	Lets you reboot device, restore factory defaults, upload new firmware, and change the device long and short names.	119
Terminal	Lets you change current settings for a terminal.	82
Tunnel	Lets you change the current configuration settings for an incoming tunnel connection.	71
Virtual IP	Allows you to view and configure Virtual IP settings.	53
VPN	Lets you view and configure VPN settings.	55

Web Manager Page (continued)	Description	See Page
XML	Lets you export XML configuration and status records, and import XML configuration records.	122

6: Network Settings

The Network Settings show the status of the network device interface/link and lets you configure the settings on the device. Interface settings are related to the configuration of the IP and related protocols. Link settings are related to the physical link connection, which carries the IP traffic.

The PremierWave XC HSPA+ contains one Ethernet and one Cellular interface. The Ethernet interface is called Network 1 or eth0, and the Cellular interface is also called Network 2 or wwan0.

Notes:

- ◆ Some settings require a reboot to take effect. These settings are noted below.
- ◆ Wait a minimum of 25-30 seconds after rebooting the unit before attempting to make any subsequent connections.
- ◆ The blue text in the XML command strings of this chapter are to be replaced with a user-specified name.

Network 1 Status

In the Network 1 status pages, you can view both the current interface operational settings as well as the settings that would take effect upon a device reboot, as well as Link, QoS and Failover status information.

- ◆ To view Ethernet (eth0) Interface status, click **Network** on the menu and select **Network 1 -> Interface -> Status**.
- ◆ To view Ethernet (eth0) Link status, click **Network** on the menu and select **Network 1 -> Link -> Status**.
- ◆ To view Ethernet (eth0) QoS status, click **Network** on the menu and select **Network 1 -> QoS -> Status**.
- ◆ To view Ethernet (eth0) Failover status, click **Network** on the menu and select **Network 1 -> Failover -> Status**.

Network 1 (eth0) Interface Settings

Table 6-1 shows the network interface settings that can be configured.

Table 6-1 Network Interface Settings

Network Interface Settings	Description
State	Select to enable or disable the interface.
IPv4 State	Select to enable or disable the IPv4 state.

Network Interface Settings (continued)	Description
BOOTP Client	<p>Select to turn On or Off. At boot up, after the physical link is up, the PremierWave device will attempt to obtain IPv4 settings from a BOOTP server.</p> <p>Note: Overrides the configured IPv4 address/mask, gateway, hostname, and domain. When DHCP is Enabled, the system automatically uses DHCP, regardless of whether BOOTP is Enabled. Changing this value requires you to reboot the device.</p>
DHCP Client	<p>Select to turn On or Off. At boot up, after the physical link is up, the PremierWave XC HSPA+ unit will attempt to obtain IPv4 settings from a DHCP server and will periodically renew these settings with the server.</p> <p>Note: Overrides BOOTP, the configured IPv4 address/mask, gateway, hostname, and domain. Changing this value requires you to reboot the device.</p> <p>Note: Within Web Manager, click Renew to renew the DHCP lease.</p>
Priority	<p>Priority ranges from 0-10.</p> <p>Note: Lower priority number means higher preference.</p>
IP Address	<p>Enter the static IPv4 address to use for the interface. You may enter it alone or in CIDR format.</p> <p>Note: This setting will be used if Static IP is active (both DHCP and BOOTP are Disabled). Changing this value requires you to reboot the device. When DHCP or BOOTP is enabled, the PremierWave XC HSPA+ device tries to obtain an IPv4 address from a DHCP or BOOTP server. If it cannot, the PremierWave XC HSPA+ unit generates and uses an Auto IP address in the range of 169.254.xxx.xxx, with a network mask of 255.255.0.0.</p>
Default Gateway	<p>Enter the IPv4 address of the router for this network.</p> <p>Note: This setting will be used if Static IP is active (both DHCP and BOOTP are Disabled).</p>
Hostname	<p>Enter the hostname for the interface. It must begin with a letter or number, continue with a sequence of letters, numbers, or hyphens, and end with a letter or number. This setting will take effect immediately, but will not register the hostname with a DNS server until the next reboot.</p>
Domain	<p>Enter the domain name suffix for the interface.</p> <p>Note: This setting will be used when either Static IP or Auto IP is active, or if DHCP/BOOTP is active and no Domain Suffix was acquired from the server.</p>
DHCP Client ID	<p>Enter the ID if the DHCP server requires a DHCP Client ID option. The DHCP server's lease table shows IP addresses and MAC addresses for devices. The lease table shows the Client ID, in hexadecimal notation, instead of the PremierWave XC HSPA+ intelligent gateway MAC address.</p>
Primary DNS	<p>Enter the IP address of the primary Domain Name Server.</p> <p>Note: This setting will be used when either Static IP or Auto IP is active, or if DHCP/BOOTP is active and no DNS server was acquired from the server.</p>
Secondary DNS	<p>Enter the IP address of the secondary Domain Name Server.</p> <p>Note: This setting will be used when either Static IP or Auto IP is active, or if DHCP/BOOTP is active and no DNS server was acquired from the server.</p>
MTU	<p>When DHCP is enabled, the MTU size is (usually) provided with the IP address. When not provided by the DHCP server, or using a static configuration, this value is used. The MTU size can be from 576 to 1500 bytes, the default being 1500 bytes.</p>

Network Interface Settings (continued)	Description
IPv6 State	Select to enable or disable the IPv6 state.
IPv6 DHCP Client	Select to turn On or Off . <ul style="list-style-type: none"> ◆ On: will provide an additional IPv6 address in addition to the displayed Link Local IPv6 address and DHCPv6 IPv6 address. This is the auto configuration address provided by the IPv6 router. ◆ Off: will not display auto configured IPv6 address in CLI or Web UI.
IPv6 Address	Enter the static IPv6 address to use for the interface. <p><i>Note: This setting is used if Static IPv6 is active (DHCPv6 is Disabled). Changing this value requires a reboot. When DHCPv6 is enabled, the XPort Pro Lx6 tries to obtain an IPv6 address from a DHCPv6 server. If it cannot, then XPort Pro Lx6 generates and uses a Link local IPv6 address.</i></p>
IPv6 Default Gateway	Enter the default IPv6 Default Gateway.
IPv6 Domain	Enter the IPv6 domain name suffix for the interface. <p><i>Note: This setting will be used when either Static IP or Auto IP is active, or if DHCP/BOOTP is active and no Domain Suffix was acquired from the server.</i></p>
IPv6 Primary DNS	Enter the IPv6 address of the primary Domain Name Server. <p><i>Note: This setting will be used when either Static IP or Auto IP is active, or if DHCP/BOOTP is active and no DNS server was acquired from the server.</i></p>
IPv6 Secondary DNS	Enter the IPv6 address of the secondary Domain Name Server. <p><i>Note: This setting will be used when either Static IP or Auto IP is active, or if DHCP/BOOTP is active and no DNS server was acquired from the server.</i></p>

To Configure Network 1 Interface Settings

Using Web Manager

- ◆ To modify Ethernet (eth0) settings, click **Network** on the menu and select **Network 1 -> Interface -> Configuration**.

Using the CLI

- ◆ To enter the eth0 command level: `enable -> config -> if 1`

Using XML

- ◆ Include in your file: `<configgroup name="interface" instance="eth0">`

Network 1 (eth0) Link Settings

Physical link parameters can be configured for an Ethernet (eth0) Network Link (see [Table 6-2](#)).

Table 6-2 Network 1 (eth0) Link Settings

Network 1 Ethernet (eth0) Link Settings	Description
Speed	Select the Ethernet link speed. (Default is Auto) ◆ Auto = Auto-negotiation of Link Speed ◆ 10 Mbps = Force 10 Mbps ◆ 100 Mbps = Force 100 Mbps
Duplex	Select the Ethernet link duplex mode. (Default is Auto) ◆ Auto = Auto-negotiation of Link Duplex ◆ Half = Force Half Duplex ◆ Full = Force Full Duplex

Notes:

- ◆ When speed is **Auto**, duplex must be **Auto** or **Half**.
- ◆ When speed is not **Auto**, duplex must be **Half** or **Full**.
- ◆ Fixed speed Full duplex will produce errors connected to Auto, due to duplex mismatch.

To Configure Network 1 Link Settings

Using Web Manager

- ◆ To modify Ethernet (eth0) Link information, click **Network** on the menu and select **Network 1 > Link > Configuration**.

Using the CLI

- ◆ To enter the eth0 Link command level: `enable -> config -> if 1 -> link`

Using XML

- ◆ Include in your file: `<configgroup name="ethernet" instance="eth0">\`

Network 1 (eth0) QoS

QoS (Quality of Service) can be enabled and configured for both Network 1 (eth0) and Network 2 (wwan0). If enabled, the router will control the flow of outbound traffic according to the user-defined filters. In other words, QoS improves performance by allowing the user to prioritize applications. Filters can be defined to prioritize traffic based on the source or destination network, source or destination port, or the source MAC address. Up to 32 user-defined filters can be added. The following are predefined priority classes:

- ◆ Network Control and Internetwork Control are typically used for network control packets such as ICMP and have the highest priorities.

- ◆ Move bandwidth allocation is a minimum 5% each to Network control.
- ◆ Voice: Bandwidth allocation is minimum 30%.
- ◆ Video: Bandwidth allocation is minimum 20%.
- ◆ Critical Applications: Bandwidth allocation is minimum 15%.
- ◆ Excellent Effort: Bandwidth allocation is minimum 10%.
- ◆ Best Effort: Bandwidth allocation is minimum 10%.
- ◆ Background: Bandwidth allocation is minimum 5% and has the lowest priority.

[Table 6-3](#) shows the network QoS settings that can be configured including adding new filters.

Table 6-3 Network 1 (eth0) QoS Settings

Network 1 (eth0) Settings	Description
State	Click to enable or disable state.
Import filters	Click to enable or disable import filters to import configurations from other interfaces.
Uplink Speed	Enter the maximum uplink speed. Set 0 to set speed to default.
Delete	Click the checkbox to the left of any existing QoS filter to be deleted and click the Submit button.
Filter type	Select the filter type from the drop-down window: <ul style="list-style-type: none"> ◆ Network ◆ Port
Network	Enter the Network, if the Network filter type is selected.
Ports	Enter the Port, if the Port filter type is selected.
Priority	Select the priority of the filter from the drop-down menu.

Table 6-4 Adding or Deleting Network 1 (eth0) QoS Settings

Adding or Deleting Network 1 (eth0) Settings	Description
Delete	Click the checkbox to the left of any existing QoS filter to be deleted and click the Submit button.
Filter type	Select the filter type from the drop-down window: <ul style="list-style-type: none"> ◆ Network ◆ Port
Network	Enter the Network, if the Network filter type is selected.
Ports	Enter the Port, if the Port filter type is selected.
Priority	Select the priority of the filter from the drop-down menu.
Submit	Click Submit after adding information for a new filter.

To Configure Network 1 QoS Settings

Using Web Manager

- ◆ To modify Ethernet 1 (eth0) QoS information, click **Network** on the menu and select **Network 1 > QoS > Configuration**.

Using the CLI

- ◆ To enter the eth0 QoS command level: enable -> config -> if 1 -> qos

Using XML

- ◆ Include in your file: `<configgroup name="qos" instance="eth0">`

Network 1 (eth0) Failover

The PremierWave XC HSPA+ intelligent gateway provides Cellular WAN network failover, in the form of a "dead remote host reachability" mechanism (essentially a ping against a known host). If the remote host is determined to be not reachable, the device will failover to the Wi-Fi/Cellular interface. If the remote host is determined to be reachable, the device will failback to the Ethernet interface.

Table 6-5 Network 1 (eth0) Failover Settings

Network 1 (Failover) Settings	Description
State	Click to enable or disable state.
Failover Interface	Always select wwan0 in the PremierWave XC HSPA+ intelligent gateway.
Hostname	Enter the remote host to test reachability.
Method	Select ICMP or TCP based ping.
Timeout	Indicate the interval to wait for ping response from remote host.
Interval	Indicate the interval in which to test reachability
Failover Threshold	Indicate the allowed number of failed pings – after which the device will failover to the cellular interface.
Failback Threshold	Indicate the number of successful pings – after which the device will failback to the Ethernet interface.

To Configure Network 1 Failover Settings

Using Web Manager

- ◆ To modify Failover settings, click **Network** on the menu and select **Network 1 > Failover > Configuration**.

Using the CLI

- ◆ To enter the eth0 link command level: enable -> config -> if 1 -> failover

Using XML

- ◆ Include in your file: `<configgroup name="network failover" instance="eth0">`

Network 2 Status

In the Network 2 status pages, you can view both the current interface operational settings as well as the settings that would take effect upon a device reboot, as well as Link, QoS and Failover status information.

- ◆ To view Ethernet (wlan0) Interface status, click **Network** on the menu and select **Network 2 -> Interface -> Status**.
- ◆ To view Ethernet (wlan0) Link status, click **Network** on the menu and select **Network 2 -> Link -> Status**.
- ◆ To view Ethernet (wlan0) QoS status, click **Network** on the menu and select **Network 2 -> QoS -> Status**.

Network 2 (Cellular “wwan0”) Interface Settings

This page is used to view the status of the cellular interface on the device.

Note: *Statistics are as measured by the device since bootup. Your service provider may account for data usage differently.*

This page is used to configure the wwan0 interface on the device. To see the effect of these items after a reboot, view the Status page.

Table 6-6 Network 2 (wwan0) Interface Settings

Network 2 (wwan0) Interface Settings	Description
State	Select to enable or disable the interface.
Priority	It ranges from 0-10. Note: <i>Lower priority number means higher preference.</i>
Connection Mode	<ul style="list-style-type: none"> ◆ The Always On connection mode keeps the device always connected to the cellular network. ◆ The On Demand connection mode leaves the link quiescent until an application attempts to make use of the cellular network connection. Be aware that in this mode, the first attempt to initiate a connection from the device server may fail, since a new IP address may need to be negotiated. ◆ The Shoulder Tap connection mode requires a short message (SMS) to make the link active. See the SMS Inbound configuration for details on the message syntax requirements.
Idle Timeout	If the connection mode is 'On Demand' or 'Shoulder Tap' and there is no network activity for Idle Timeout duration the device will automatically disconnect from the cellular network.
Primary DNS	Enter the IP address of the primary Domain Name Server. Note: <i>This setting will be used when either Static IP or Auto IP is active, or if DHCP/BOOTP is active and no DNS server was acquired from the server.</i>
Secondary DNS	Enter the IP address of the secondary Domain Name Server. Note: <i>This setting will be used when either Static IP or Auto IP is active, or if DHCP/BOOTP is active and no DNS server was acquired from the server.</i>

To Configure Network 2 Interface Settings

Using Web Manager

- ◆ To modify network 2 wwan0 interface information, click **Network** on the menu and select **Network 2 > Interface > Configuration**.

Using the CLI

- ◆ To enter the cellular command level: `enable -> config -> if 2`

Using XML

- ◆ Include in your file: `configgroup name = "cellular interface" instance = "wwan0">`

Network 2 (Cellular “wwan0”) Link Settings

This page shows configuration of an wwan0 link on the device.

Table 6-7 Network 2 (wlan0) Link Settings

Network 2 Link Settings	Description
APN	Enter the configurable network identifier used by a mobile device when connecting to a GSM carrier.
Username	Enter the Username for dial up to cellular carrier, if required.
Password	Enter the Password for dial up to cellular carrier, if required.
Dialup String	Enter the modem string used for making connection to carrier.
Roaming	Enable or disable the network roaming.

To Configure Network 2 Link Settings

Using Web Manager

- ◆ To modify network 2 wwan0 interface information, click **Network** on the menu and select **Network 2 > Link > Configuration**.

Using the CLI

- ◆ To enter the link command level: `enable -> if 2 -> link`

Using XML

- ◆ Include in your file: `<configgroup name = "wwan0 link" instance = "wlan0">`

Network 2 (Cellular “wan0”) QoS

QoS (Quality of Service) can be enabled and configured for both Network 1 (eth0) and Network 2 (wan0). If enabled, the router will control the flow of outbound traffic according to the user-defined filters. In other words, QoS improves performance by allowing the user to prioritize applications. Filters can be defined to prioritize traffic based on the source or destination network, source or destination port, or the source MAC address. Up to 32 user-defined filters can be added. The following are predefined priority classes:

- ◆ Network Control and Internetwork Control are typically used for network control packets such as ICMP and have the highest priorities.
- ◆ Bandwidth allocation is a minimum 5% each.
- ◆ Voice: Bandwidth allocation is minimum 30%.
- ◆ Video: Bandwidth allocation is minimum 20%.
- ◆ Critical Applications: Bandwidth allocation is minimum 15%.
- ◆ Excellent Effort: Bandwidth allocation is minimum 10%.
- ◆ Best Effort: Bandwidth allocation is minimum 10%.
- ◆ Background: Bandwidth allocation is minimum 5% and has the lowest priority.

[Table 6-8](#) shows the network QoS settings that can be configured including adding new filters.

Table 6-8 Network 2 (wan0) QoS Settings

Network 2 (QoS) Settings	Description
State	Click to enable or disable state.
Import filters	Click to enable or disable import filters to import configurations from other interfaces.
Uplink Speed	Enter the maximum uplink speed. Set 0 to set speed to default.

Table 6-9 Adding or Deleting Network 2 (wan0) QoS Settings

Adding or Deleting Network 2 (QoS) Settings	Description
Delete	Click the checkbox to the left of any existing QoS filter to be deleted and click the Submit button.
Filter type	Select the filter type from the drop-down window: <ul style="list-style-type: none"> ◆ Mac Address ◆ Network ◆ Port
MAC Address	Enter the MAC address, if the MAC Address filter type is selected.
Network	Enter the Network, if the Network filter type is selected.
Ports	Enter the Port, if the Port filter type is selected.
Priority	Select the priority of the filter from the drop-down menu.

To Configure Network 2 QoS Settings

Using Web Manager

- ◆ To modify Ethernet (eth0) QoS information, click **Network** on the menu and select **Network 2 > QoS > Configuration**.

Using the CLI

- ◆ To enter the eth0 QoS command level: `enable -> config -> if 2 -> qos`

Using XML

- ◆ Include in your file: `<configgroup name="cellular" instance="wwan0">`

Gateway

The PremierWave XNXC HSPA+ intelligent gateway can be configured as a cellularwireless router with DHCP server functionality.

Status

This page displays the current configuration and statistics information for the gateway.

- ◆ To view gateway status: click **Gateway** on the menu and select **Status**.

WAN

Table 6-10 WAN Configuration

Gateway Settings	Description
Operating Mode	Select the type of operating mode: <ul style="list-style-type: none"> ◆ Disabled: prevents the device to be used as a gateway; use the device normally. ◆ Gateway: allows the device to be used as a router with NAT. ◆ Router: allows the device to be used as a router without NAT.
Firewall	Select to enable or disable firewall: <ul style="list-style-type: none"> ◆ Enabled: enables the device firewall. ◆ Disabled: disable the device firewall.
MAC Address filter	Select to enable or disable the MAC address filter.
Interface	Specify the WAN interface. Generally wwan0 (cellular) interface.
IP Address	Assign a static IP address to the gateway.
IPv6 Address	Assign a static IPv6 address to the gateway.
Primary DNS	Enter the IP address of the primary Domain Name Server. <i>Note: This setting will be used when either Static IP or Auto IP is active, or if DHCP/BOOTP is active and no DNS server was acquired from the server.</i>

Gateway Settings	Description
Secondary DNS	Enter the IP address of the secondary Domain Name Server. <i>Note:</i> This setting will be used when either Static IP or Auto IP is active, or if DHCP/BOOTP is active and no DNS server was acquired from the server.

WAN MAC Address Filters

Accept or drop traffic from specified MAC addresses using the settings below.

Table 6-11 Adding a New MAC Address Filters

Adding or Deleting New MAC Address Filter Settings	Description
Delete	Click the checkbox to the left of any existing mac address filter to be deleted and click the Submit button.
MAC Address	Enter a new mac address to add a new filter.
Action	Select to ACCEPT or DROP above indicated MAC Address field.
Add	Click Add after adding new MAC address filter information.

To Configure Gateway WAN Settings

Using Web Manager

- ◆ To modify gateway WAN information, click **Gateway** on the menu and select **Configuration > WAN**.

Using the CLI

- ◆ To enter the gateway command level: `enable -> config -> gateway`

Using XML

- ◆ Include in your file: `<configgroup name="gateway"> <configitem name="wan">`

Port Forwarding

Port forwarding allows remote computers (for example, computers on the Internet) to connect to a specific computer or service within a private local-area network (LAN). Port Forwarding rules apply to inbound traffic and will not work under these conditions:

- ◆ The IP of the cellular device is not directly reachable from outside of the cellular providers network. The port forwarding rules will not work if the device does not receive any traffic.
- ◆ Hosts within the cellular providers network cannot reach the device.
- ◆ The port is blocked by the cellular provider.
- ◆ If traffic to certain ports is blocked before it reaches the PremierWave device, the port forwarding rules will still not work even with a public and accessible IP.

Table 6-12 Port Forwarding Rules List

Port Forwarding Rule	Description
Enabled	Enables the port forwarding rule.
Delete	Deletes the port forwarding rule.
Name	User friendly name for the rule. Click on the [Edit] icon to make changes.
Ingress IP Address: Port Range	Port or Port range for the rule.
Protocol	Protocols for the rule: TCP, UDP, or Both.
IP Address: Target Port	Target for the port forwarding rule.

Table 6-13 Adding a New Port Forwarding Rule

To Configure Gateway Port Forwarding Settings

Using Web Manager

- ◆ To modify gateway port forwarding information, click **Gateway** on the menu and select **Configuration > Port Forwarding**.

Using the CLI

- ◆ To enter the gateway command level: enable -> config -> gateway -> port forwarding rule <number>

Using XML

- ◆ Include in your file: <configgroup name="gateway"> <configitem name="port forwarding" instance="<number>">

Static Routes

Allows the user to add routes to the device routing table.

Table 6-14 Static Route Setting Routes

Static Route Settings	Description
Enabled	Enables the static route.
Delete	Deletes the static route.
Name	User friendly name for the route. Click on the [Edit] icon to make changes.
Route	Network or Host for the route.
Applied	If the route was successfully applied. Routing table updates require a reboot and route needs to be valid as per other device configurable.

Table 6-15 Adding a New Static Route

Adding New Static Route Settings	Description
Name	Enter the user friendly name for the route.
Network	Enter the Network or Host for the route.
Gateway	Enter the Gateway for the route.
Interface	Select the Interface for the route.
Metric	Enter the priority for the route. Lower metric means higher priority.
Add	Click Add after adding new route information.

To Configure Gateway Static Route Settings

Using Web Manager

- ◆ To modify gateway static route information, click **Gateway** on the menu and select **Configuration > Static Routes**.

Using the CLI

- ◆ To enter the gateway command level: `enable -> config -> gateway -> static route <number>`

Using XML

- ◆ Include in your file: `<configgroup name="gateway"> <configitem name="static routes" instance="<number>"`

DHCP Server

Allows the user to configure the device as a DHCP server.

Table 6-16 DHCP Settings

DHCP Settings	Description
Lease time	Enter the duration for which lease is initially assigned. Clients must renew after this duration.
State	Enable or Disable the DHCP server for the DHCP settings. <ul style="list-style-type: none"> ◆ Enabled: DHCP server is enabled. ◆ Disabled: DHCP server is disabled.
Start IP Address	View or edit the Start IP Address of address pool.
End IP Address	View or edit the End IP Address of address pool.
State	Enable or Disable the DHCP server for the DHCPv6 settings. <ul style="list-style-type: none"> ◆ Enabled: DHCP server is enabled. ◆ Disabled: DHCP server is disabled.
Start IPv6 Address	Start IPv6 Address of address pool.
End IPv6 Address	End IPv6 Address of address pool.

To Configure Gateway DHCP Server Settings

Using Web Manager

- ◆ To modify gateway DHCP server information, click **Gateway** on the menu and select **Configuration > DHCP Server**.

Using the CLI

- ◆ To enter the gateway command level: `enable -> config -> gateway -> dhcp server`

Using XML

- ◆ Include in your file: `<configgroup name = "dhcp server">`

Static Lease Listing

The device also provides the ability to pre-assign specific IP addresses to connected devices using static leases. This would ensure that the connected device (identified by the MAC address) always gets the same IP address even while using DHCP.

Table 6-17 Static Lease Listing

Static Lease List Settings	Description
Delete	Click checkbox beside existing static lease MAC Address/IP Address to delete, if available and if desired.
MAC Address	MAC Address of existing static leases are listed here.
IP Address	Static IP Address of existing static leases are listed here.
IPv6 Address	Static IPv6 Address of existing static leases are listed here.

Table 6-18 Add a Static Lease

Add a Static Lease Settings	Description
MAC Address	Enter the MAC Address of the static lease to be added.
IP Address	Enter static IP address of the static lease to be added.
IPv6 Address	Enter static IPv6 address of the static lease to be added.
Add	Click Add after adding new static lease information.

Routing Protocols

The PremierWave XC HSPA+ intelligent gateway allows the configuration of routing protocols. Routing protocols specify how routers communicate with each other, disseminating information that enables the selection of routes between any two nodes on a computer network. Routing algorithms determine the specific choice of route. Each router has a prior knowledge of networks directly attached to it. A routing protocol shares this information among immediate neighbors first, then through the network. This way, routers gain knowledge of the topology of the network. The PremierWave device supports RIP and OSPF protocols.

Table 6-19 Routing Protocol Settings

Routing Settings	Description
State (RIP)	Select to enable or disable the RIP state.
Version	Select how the RIP is to be configured. It can accept Version 1 , Version 2 , or Version 1 and 2 .
Update Interval	Indicate the number of seconds for the Update Interval. Send unsolicited Response message every Update Interval seconds containing the complete routing table to all neighboring RIP routers.
Timeout Interval	Indicate the number of seconds for the Timeout Interval. Upon expiration of the Timeout Interval, the routes are no longer valid, however, they are retained in the routing table for a short time so that neighbors can be notified that the route has been dropped.
GC Interval	Indicate the number of seconds for the GC Interval. Upon expiration of the GC Interval, the routes are finally removed from the routing table.
State (OSPF)	Select to enable or disable the OSPF state.
Hello Interval	Indicate the number of seconds for the Hello Interval. Hello packet will be sent every Hello Interval seconds.
Dead Interval	Indicate the number of seconds for the Dead Interval. Sets the time period for which hello packets must not have been seen before neighbors declare the router down.

To Configure Gateway Routing Protocol Settings

Using Web Manager

- ◆ To modify gateway protocol settings, click **Gateway** on the menu and select **Configuration > Routing Protocol**.

Using the CLI

- ◆ To enter the gateway command level: `enable -> config -> gateway -> routing protocols`

Using XML

- ◆ Include in your file: `<configgroup name = "routing protocols">`

Virtual IP

The PremierWave XC HSPA+ intelligent gateway allows the configuration of Virtual IP addresses. Virtual IP is a means to map an externally visible IP address to LAN-side IP addresses. PremierWave units will support creating up to three virtual IP address mappings by creating loop back interfaces and publishing this information via the routing protocols.

Table 6-20 Virtual IP Settings

Virtual IP Settings	Description
Enabled (checkbox)	Uncheck the Enabled checkbox adjacent to a virtual IP address to enable it. Keep the checkbox checked to keep the virtual IP address enabled. A virtual IP address is enabled by default.

Virtual IP Settings	Description
Delete (checkbox)	Check the Delete checkbox adjacent to a virtual IP address to be deleted, clicking the Submit button.
Name	The name of an existing virtual IP address.
IP Address	An existing virtual IP address to which the LAN IP address is to be mapped.
LAN IP Address	An existing LAN IP address to which the virtual IP address is to be mapped.

Table 6-21 Adding a Virtual IP

Virtual IP Settings	Description
Name	Enter a name of the virtual IP address.
IP Address	Enter the virtual IP address to which the LAN IP address is to be mapped.
LAN IP Address	Enter the LAN IP address to which the virtual IP address is to be mapped.
Add	Click Add after adding new virtual IP information.

To Configure Gateway Virtual IP

Using Web Manager

- ◆ To modify gateway DHCP server information, click **Gateway** on the menu and select **Configuration > Virtual IP**.

Using the CLI

- ◆ To enter the gateway command level: enable -> config -> gateway

Using XML

- ◆ Include in your file: <configgroup name = "virtual ip">

DDNS

The PremierWave XC HSPA+ intelligent gateway displays and allows configuration of the DDNS.

Table 6-22 DDNS Configuration

DDNS Settings	Description
State	Select to enable or disable the DDNS state.
Type	Select the DDNS IP address type.
User Name	Enter a user name for the DDNS account.
Password	Enter a password for the DDNS account.
Host Name	Specify the host name to be used to update the DDNS.
Interval	Indicate the interval of minutes the IP address will be checked. The DDNS will be updated if the IP address has changed.
Update DDNS (button)	Click this button, to save updated configuration information to the Flash.

To Configure Gateway WAN Settings

Using Web Manager

- ◆ To view or configure DDNS information, click **DDNS** in the menu.

Using the CLI

- ◆ To enter the gateway command level: `enable -> config -> ddns`

Using XML

- ◆ Not any.

VPN

The PremierWave XC HSPA+ intelligent gateway provides the option to configure a virtual private network (VPN) to extend a private network across a public network. Data may be sent and received across a shared or public network as if directly connected to the private network, while benefiting from the functionality, security and management policies of the private network.

Table 6-23 VPN Configuration

VPN Settings	Description
Show details (link)	Click the Show details link to view the vpn log in a separate web browser window.
CONFIGURATION	
Name	Enter the user-defined name of the VPN connection.
State	Select to enable or disable the VPN connection.
Connection Type	Select connection type: <ul style="list-style-type: none"> ◆ Host to Subnet - VPN tunnel for local and remote subnets are fixed. ◆ Host to Host - VPN tunnel for remote subnet area is dynamic and local subnet is fixed.
IKEv2	Select the IKE version 2 setting to be used from the drop-down menu. <ul style="list-style-type: none"> ◆ Permit - no IKEv2 should be transmitted, but will be accepted if the other end initiates to us with IKEv2. This is the default setting. ◆ Never - no IKEv2 negotiation should be transmitted or accepted. ◆ Propose - the device will permit IKEv2 and also use it as the default to initiate. ◆ Insist - the device will only accept and receive IKEv2 and IKEv1 negotiations will be rejected.
Authentication Mode	Select the authentication mode of the IPSec VPN: <ul style="list-style-type: none"> ◆ PSK - Pre-shared key is used when there is a single key common to both ends of the VPN. ◆ RSA - Uses RSA digital signatures. ◆ XAUTH - Provides an additional level of authentication by allowing the IPSec gateway to request extended authentication from remote users, thus forcing remote users to respond with their credentials before being allowed access to the VPN.

VPN Settings	Description
Mode Configuration	Click to enable or disable extended authentication operation and the settings provided to the client during the configuration exchange.
Type	Select the VPN type: <ul style="list-style-type: none"> ◆ Tunnel - Tunnel mode is used for protecting traffic between networks, when traffic must pass through intermediate, untrusted network. ◆ Transport - Transport mode is used for end-to-end communication (for example, for communications between a client and a server).
Interface	Select the interface to use to connect to VPN Gateway.
REMOTE NETWORK	
Endpoint	Enter the remote VPN gateway's IP address.
Subnet	Enter the subnet behind the VPN gateway.
ID	Specify the identifier through which to receive from the remote host during Phase 1 negotiation.
Router/Next Hop	Enter the next-hop gateway IP address for the VPN gateway.
LOCAL NETWORK	
Subnet	Define which local devices have access to or can be accessed from the VPN connection.
ID	Specify the identifier sent to the remote host during Phase 1 negotiation.
Router/Next Hop	Enter the next-hop gateway IP address for our connection to the public network.
KEY MANAGEMENT	
Perfect Forward Secrecy (PFS)	Select to enable or disable whether Perfect Forward Secrecy of keys is desired on the connection's keying channel. Enabling this feature will require IKE to generate a new set of keys in Phase 2 rather than using the same key generated in Phase 1.
Pre-shared key (PSK)	Enter the pre-shared key to be used in the IPSec setting between the Local and VPN Gateway.
ISAKMP PHASE 1 (IKE)	
Aggressive Mode	Select to enable or disable Aggressive Mode. In Aggressive mode, IKE tries to combine as much information into fewer packets while maintaining security. Aggressive mode is slightly faster but less secure.
NAT Traversal	Select to enable or disable NAT Traversal. If there is an external NAT device between VPN tunnels, the user must enable NAT Traversal.
Encryption	Select the encryption algorithm in key exchange.
Authentication	Select the hash algorithm in key exchange.
DH Group	Select the Diffie-Hellman group (the Key Exchange group between the Remote and VPN Gateways).
IKE Lifetime	Enter the lifetime, in hours, for IKE SA.
ISAKMP PHASE 2 (ESP)	
Encryption	Select the encryption Algorithm in data exchange.
Authentication	Select the hash Algorithm in data exchange.
DH Group	Select the Diffie-Hellman groups (the Key Exchange group between the Remote and VPN Gateways) for Phase 2.
SA Lifetime	Enter the lifetime, in hours, for SA in Phase 2.

VPN Settings	Description
Unreachable Host Detection	
Host	Enter the Host to use failover host and ping interval to monitor connectivity with a host on the remote network.
Ping Interval	Indicate the ping interval, in minutes, to use failover host and ping interval to monitor connectivity with a host on the remote network.
Max Tries	Enter the tries for the VPN tunnel is restarted if Max Tries pings to the host fail.

To Configure VPN Settings

Using Web Manager

- ◆ To view or configure VPN information, click **VPN** in the menu.

Using the CLI

- ◆ To enter the VPN command level: `enable -> config -> vpn`

Using XML

- ◆ Include in your file: `<configgroup name = "vpn">`

GRE Settings

GRE tunneling is available on the PremierWave XC HSPA+ intelligent gateway, providing more capabilities than IP-in-IP tunneling. For example, it supports transporting multicast traffic and IPv6 through a GRE tunnel.

Table 6-24 GRE Settings

GRE Settings	Description
Name	Enter the user-defined name of the GRE tunnel.
State	Select to enable and disable GRE tunnel.
IP Address	Assign an IP address/mask for the GRE tunnel.
MTU	Enter the number of bytes indicating the largest physical packet size that the network can transmit.
Local Network	Select the local network to use the GRE tunnel. Select vpn to use the VPN network. Select any to use any available interface to remote host.
Remote Host	Enter the remote IP address to use for the GRE tunnel.
Remote Network	Enter the remote network to use for the GRE tunnel.

To Configure Tunnel Serial Settings

Using Web Manager

- ◆ To configure the GRE for a specific tunnel, click **GRE**.

Using the CLI

- ◆ To enter GRE command level: enable -> gre

Using XML

- ◆ Include in your file: `<configgroup name="gre">`

7: Cellular

The Cellular page displays the configuration and status for the Cellular module.

Cellular Settings	Description
PIN Lock	Enable to prevent unauthorized use of the SIM card.
PIN	Enter PIN combination to enable PIN Lock. Caution: If you enter the PIN incorrectly 3 times, the SIM card will lock, and you will need a PIN Unlocking Key (PUK) to unlock your SIM card. PUK is required to unlock SIM cards that have become locked following 3 successive incorrect PIN entries. Caution: If you enter the PUK incorrectly 10 times, the SIM card will be permanently locked and no longer operable.
Allowed Bands	Select the allowed bands, determining the frequency band usage of the device. Select/Unselect individual bands to restrict the allowed bands to a specific band or band combination.
Antenna Diversity	Select to enable or disable. Antenna Diversity controls the RX receiver antenna diversity support to achieve verification of received paths and support of CTIA 3.0 diversity tests (relevant for application approval). <ul style="list-style-type: none">◆ Enabled uses both antennas for RX operation. Enables RX diversity functionality by activating both antennas for RX operation. This setting becomes effective after next restart of the device.◆ Disabled uses only the primary antenna for RX operation. Disables RX diversity functionality. Activate only the first antenna for RX operation, i.e., use the primary antenna for reception. The secondary (diversity) receiver path is switched off. This setting becomes effective after next restart of the device.

To Configure Cellular Settings

Using Web Manager

- ◆ Click **Cellular** on the menu.

Using the CLI

- ◆ To enter the cellular command level: `enable -> config -> cellular`

Using XML

- ◆ Include in your file: `<configgroup name = "cellular">`

Typical Cellular Error (errcodes)

The following is a list of common errors that may appear in the Cellular module.

- ◆ PH-SIM PIN required
- ◆ PH-FSIM PIN required
- ◆ PH-FSIM PUK required
- ◆ SIM not inserted
- ◆ SIM PIN required
- ◆ SIM PUK required
- ◆ SIM failure
- ◆ SIM busy
- ◆ SIM wrong
- ◆ incorrect password
- ◆ SIM PIN2 required
- ◆ SIM PUK2 required

8: Input/Output Ports

Relay Output

Note: When the relay is energized/turned on, the relay is closed, connecting both relay ports on the I/O connector through the relay. When the relay is turned off, the signal path is open, disconnecting the relay ports on the I/O connector.

Table 8-1 Relay Output Settings

Relay Output Settings	Description
State	This field is found in the Relay Status page. Indicates state of the relay. Select On or Off to change the state of the relay.
Title	Enter the relay title as it will appear in web manager, XML and CLI. Leave this field blank to utilize the default "Relay N", where N is the relay number. For example, you can name the reading, "Buzzer", if a buzzer is connected to the PremierWave device.
Latch	Enable or disable Latch controls which determine how a relay will be turned off. <ul style="list-style-type: none">◆ Selecting Enabled will require a user to explicitly reset latched relay and then turn it off.◆ Selecting Disabled, the relay will automatically turn off after any and all of the alarm triggers are no longer active.

To Configure Relay Settings

Using Web Manager

- ◆ To configure relay output, go to the **Setup** tab/page and click **Relay > Relay 1 > Status** in the menu.
- ◆ To change relay state, go to the **Setup** tab/page and click **Relay > Relay 1 > Configuration** in the menu.

Using the CLI

- ◆ To enter the relay command level: `enable -> config -> relays -> relay <number>`

Using XML

Include in your file: `<configgroup name="relay" instance="<number">`

Digital Input

Table 8-2 contains additional configuration options for **Digital Input 1** and **Digital Input 2** settings:

Table 8-2 Digital Input Settings

Digital Input Settings	Description
State	This field is found in the Digital Input Status page. Indicates state of the digital input.
Title	Fill in Title to customize how the digital input status will appear in the CLI, Web Manager, and XML status. Leave Title blank for the default title of "Digital Input N", where N is the digital input number.
Normal State	Select Normal State to Low or High . When input state changes, Normal State is used to compare with the input state. If the states are different, an alarm will be triggered which is configured under "Action" menu.

To Configure Digital Input Settings

Using Web Manager

- ◆ To modify digital input information, click **Digital Input** on the menu, select either **Digital Input 1** or **Digital Input 2**, and click the **Configuration** link.

Using the CLI

- ◆ To enter the digital input command level: enable -> config -> action -> digital input 1 state change
- ◆ To enter the digital input command level: enable -> config -> action -> digital input 2 state change
- ◆ To enter the digital input command level: enable -> config -> digital inputs -> digital input <number>

Using XML

- ◆ Include in your file: <configgroup name = "action" instance = "digital input 1 state change">
- ◆ Include in your file: <configgroup name = "action" instance = "digital input 2 state change">
- ◆ Include in your file: <configgroup name="digital input" instance="<number">

9: Action Settings

Actions can be configured for alarms and reports available in the PremierWave XC HSPA+ intelligent gateway.

Alarms and Reports

PremierWave XC HSPA+ intelligent gateway updates the action settings page to display and configure the alarms. The following alarm and report actions are available in PremierWave XC HSPA+ device:

- ◆ eth0 link state change
- ◆ wwan0 link state change
- ◆ Digital input 1 state change
- ◆ Digital input 2 state change
- ◆ Device temperature change
- ◆ Cellular temperature change
- ◆ On scheduled reboot

Note: One or more types of “action” can be configured and triggered when an event occurs. *The “on scheduled reboot” alarm state will be on at the time of a scheduled reboot and will remain on till the device actually reboots (in approximately 30 seconds). These are not applicable for “on scheduled reboot” alarm: Email Alarm Reminder Interval, Normal Email, Normal Message, Normal Reminder Interval, SNMP Reminder Interval, SNMP Normal Message, and Delay.*

Actions

[Table 9-1](#) contains the configuration options for all the alarms and reports listed above.

Table 9-1 Action Settings

Action Settings	Description
Delay	Use Delay to defer alarm processing. Alarm actions will not be executed if the cause is corrected within this time.
Email	Use Email to send an email to configured Email recipients. <ul style="list-style-type: none">◆ If an Alarm Email profile number is selected, that email will be sent when the alarm is turned on. The contents of Alarm Message will be placed into the email body when an alarm email is sent. If the alarm stays on longer than the Reminder Interval, another alarm email is sent.◆ If a Normal Email profile number is selected, that email will be sent when the alarm is turned off. The contents of Normal Message will be placed into the email body when a normal email is sent. If the alarm stays off longer than the Reminder Interval, another normal email is sent.

Action Settings	Description
FTP Put	Use FTP Put to put a file on configured FTP server. Filename will be used to upload to remote FTP server. The IP Address or hostname is the FTP server to connect. Port number is port on which FTP server is listening on. Use Protocol to connect to FTP server. FTPS is a SSL encrypted communication channel and SSL Trusted Authorities must be setup with FTP server SSL certificate. Username is used to logon to FTP server. If FTP server does not require authentication, use anonymous. Password is used to logon to FTP server. If FTP server does not require authentication, a common practice is to use user's email address. If the alarm stays on or off longer than the Reminder Interval , another FTP Put is performed. In Sequential mode, connections will be attempted starting with number 1 until a connection is successful. In Simultaneous mode, all possible connections will be made.
HTTP Post	Use HTTP Post post to configured HTTP server. The URL appears behind the HTTP server IP address or hostname. E.g. http://some_http_server/some_url The IP Address or hostname is the HTTP server to connect to. Port number is the port which HTTP server is listening on. Use Protocol to connect to HTTP server. HTTPS is a SSL encrypted communication channel and SSL Trusted Authorities must be setup with HTTP server SSL certificate. Username used to logon to HTTP server if authentication is required. Password used to logon to HTTP server if authentication is required. If the alarm stays on or off longer than the Reminder Interval , another HTTP Post is performed. In Sequential mode, connections will be attempted starting with number 1 until a connection is successful. In Simultaneous mode, all possible connections will be made.
Relay	Select a Relay to switch on when this alarm is activated. Select "None" so this alarm state will have no effect on any Relay.
GPRS Roaming	Select to enable or disable GPRS roaming when this alarm is on. Select No Change so this alarm State will have no effect on GPRS roaming.
SMS	Use SMS to send SMS to a configured Recipient . The contents of Alarm Message will be placed into the SMS body when an alarm SMS is sent. If the alarm stays on longer than the Reminder Interval , another alarm SMS is sent. The contents of Normal Message will be placed into the SMS body when a normal SMS is sent. If the alarm stays off longer than the Reminder Interval, another normal SMS is sent.
SNMP Trap	Use SNMP Trap to send SNMP trap to configured trap destinations. Check to enable or disable the State . The contents of Alarm Message are included when an alarm SNMP trap is sent. If the alarm stays on longer than the Reminder Interval , another alarm SNMP Trap is sent. The contents of Normal Message are included when a normal SNMP trap is sent. If the alarm stays off longer than the Reminder Interval, another normal SNMP Trap is sent.

To Configure Action Settings

Using Web Manager

- ◆ To view Action status information, click **Action** on the menu and select **Status**.
- ◆ To modify Action information, click **Action** on the menu and select a specific action from the drop-down menu. [Alarms and Reports \(on page 63\)](#) lists the options.

Using the CLI

- ◆ To enter the eth0 link state change command level: enable -> config -> action -> eth0 link state change

- ◆ To enter the wwan0 link state change command level: enable -> config -> action -> wwan0 link state change
- ◆ To enter digital input 1 state change command level: enable -> config -> action -> digital input 1 state change
- ◆ To enter digital input 2 state change command level: enable -> config -> action -> digital input 2 state change
- ◆ To enter device temperature change command level: enable -> config -> action -> device temperature change
- ◆ To enter cellular temperature change command level: enable -> config -> action -> cellular temperature change
- ◆ To enter cellular temperature change command level: enable -> config -> action -> on scheduled reboot

Using XML

- ◆ Include in your file: `<configgroup name = "action" instance = "eth0 link state change">`
- ◆ Include in your file: `<configgroup name = "action" instance = "wwan0 link state change">`
- ◆ Include in your file: `<configgroup name = "digital input 1 state change"`
- ◆ Include in your file: `<configgroup name = "digital input 2 state change"`
- ◆ Include in your file: `<configgroup name = "device temperature change"`
- ◆ Include in your file: `<configgroup name = "cellular temperature change"`
- ◆ Include in your file:
`<configgroup name = "action" instance = "on scheduled reboot">`

Python

Python™ is a dynamic, object-oriented programming language that can be used for developing a wide range of software applications. The Lantronix PremierWave HSPA+ includes the installation of Python interpreter, making it easy to load and run custom Python scripts on your intelligent gateway.

The version of Python programming language installed on the Lantronix PremierWave intelligent gateway comes with "batteries included" by having the Python language's standard library. In addition, the developer can take advantage of thousands of available third party packages to speed up development.

IDE

Python scripts can be written with any text editor. If using Windows for development, Notepad++ is a powerful choice as this text editor includes traditional IDE features such as syntax highlighting and automatic indentation (<http://notepad-plus-plus.org/>). Notepad++ also includes the ability to customize through plugins. Some interesting plugins for the development of Python scripts for the Lantronix PremierWave platform include the following:

- ◆ **PyNPP:** <https://github.com/mpcabd/PyNPP>
This plugin allows the user to use keystrokes to launch the open Python script in the local Python interpreter for debugging and testing.
- ◆ **NppFTP:** <http://sourceforge.net/projects/nppftp/>
This plugin provides a one-click upload of a file to an FTP server. Debugging and testing on the PremierWave platform easier because PremierWave products have an FTP server through which to upload files into the file system.

Applications

The PremierWave XC HSPA+ intelligent gateway supports the ability to install and uninstall user-defined Python scripts and packages and will include the following:

bin	python	
lib	libpython{version}.so	
	<ltrx python sdk>	
	libpython{version}	"python precompiled scripts "python shared libraries

Table 9-2 contains the setting options for configuring, installing, uninstalling and running external applications via Python scripts.

Caution: Use extreme caution when installing and running scripts.

Table 9-2 Script Settings

Script Settings	Description
Enabled (checkbox)	Check the Enabled checkbox within a particular script to enable it. Uncheck the checkbox to disable the script.
Run on startup (checkbox)	Check the Run on startup checkbox within a particular script to have it run upon the start up of the PremierWave unit. Uncheck the checkbox to disable automatically running the unit upon startup.
Run on shutdown (checkbox)	Check the Run on shutdown checkbox within a particular script to have it run on shutdown of the Premierwave unit. Uncheck the checkbox to disable automatically running the script upon shutdown.
Script	Enter the path of script to run in Filesystem.
Parameter	Enter the script parameters (if any).
Output	Enter output log file (if desired) for the script to redirect output of script to file. If the name of output log contains "%t", it will translate it into timestamp (e.g., script1_%t.log => script1_2007-01-02_19-06-57.log)
Run (button)	Click the Run button to manually execute the script. Note: The script is run with configuration saved to the Flash.
Uninstall (button)	Click the Uninstall button in a Python package to uninstall it.
Remove All (button)	Click the Remove All button to uninstall all Python packages.

Script Settings	Description
Filename	Enter the package file name pathway in the file system and click the Install button to install it.

To Configure Application Settings

Using Web Manager

- ◆ To configure application scripts, click **Applications** on the menu.

Using the CLI

- ◆ To enter the application script change command level: `enable -> config -> applications`

Using XML

- ◆ Include in your file: `<configgroup name = "applications">`

10: Line and Tunnel Settings

The PremierWave XC HSPA+ intelligent gateway has two tunnels through which you may view statistics or configure the Accept Mode. The PremierWave XC HSPA+ intelligent gateway contains two serial lines. All lines use standard RS232/RS485 serial ports. All lines can be configured to operate in the following modes:

- ◆ RS232
- ◆ RS485 Full Duplex (also compatible with RS-422)
- ◆ RS485 Half Duplex, with and without termination impedance
- ◆ All serial settings such as Baud Rate, Parity, Data Bits, etc, apply to these lines.

Line Statistics

This page displays the current status and various statistics for the serial line.

Note: *The following section describes the steps to view Line 1 statistics; these steps apply to other line instances of the device.*

Using Web Manager

- ◆ To view statistics for Line 1, click **Line** in the menu and select **Line 1 -> Statistics**.

Using the CLI

- ◆ To view Line statistics: `enable -> line 1, show statistics`

Using XML

- ◆ Include in your file: `<statusgroup name="line" instance="1">`

Line Settings

Note: *The following section describes the steps to configure Line 1; these steps apply to other line instances of the device.*

To Configure Line Settings

Using Web Manager

- ◆ To configure Line 1, click **Line** in the menu and select **Line 1 -> Configuration**.

Using the CLI

- ◆ To view Line statistics: `enable -> line 1, show statistics`

Using XML

- ◆ Include in your file: `<statusgroup name="line" instance="1">`

The Line Settings allow configuration of the serial lines (ports).

Table 10-1 Line Configuration Settings

Line Settings	Description
Name	Enter a name or short description for the line, if desired. By default, there is no name specified. A name that contains white space must be quoted.
Interface	Set the interface type for the Line. The default is RS232 . Choices are: <ul style="list-style-type: none"> ◆ RS232 ◆ RS485 Full-Duplex ◆ RS485 Half-Duplex
State	Select to enable or disable the operational state of the Line. The default is Enabled .
Protocol	Set the operational protocol for the Line. The default is Tunnel . Choices are: <ul style="list-style-type: none"> ◆ None ◆ Tunnel = Serial-Network tunneling protocol.
Baud Rate	Set the Baud Rate (speed) of the Line. The default is 9600 . Any set speed between 300 and 921600 may be selected: 300, 600, 1200, 2400, 4800, 9600, 19200, 38400, 57600, 115200, 230400, 460800, 921600. When selecting a Custom baud rate, you may manually enter any value between 300 and 5000000. <i>Note: The maximum baud rate in RS232 mode is 1000000 bps. Custom baud rates are not supported when a line is configured for Command Mode.</i>
Parity	Set the Parity of the Line. The default is None .
Data Bits	Set the number of data bits for the Line. The default is 8 .
Stop Bits	Set the number of stop bits for the Line. The default is 1 .
Flow Control	<i>Note: Set the flow control for the Line. The default is None.</i> <i>Note: This field becomes available if RS232 or RS485 Full-Duplex is selected under Interface above.</i>
Gap Timer	Set the Gap Timer delay to Set the number of milliseconds to pass from the last character received before the driver forwards the received serial bytes. By default, the delay is four character periods at the current baud rate (minimum 1 msec).
Threshold	Set the number of threshold bytes which need to be received in order for the driver to forward received characters.

Table 10-2 Line Command Mode Settings

Line Command Mode Settings	Description
Mode	<p>Set the Command Mode state of the Line. When in Command Mode, a CLI session operates exclusively on the Line. Choices are:</p> <ul style="list-style-type: none"> ◆ Always ◆ User Serial String ◆ Disabled <p>Note: In order to enable Command Mode on the Line, Tunneling on the Line must be Disabled (both Connect and Accept modes). Also, custom baud rates are not supported in Command Mode.</p>
Wait Time	<p>Enter the amount of time to wait during boot time for the Serial String. This timer starts right after the Signon Message has been sent on the Serial Line and applies only if mode is "Use Serial String".</p> <p>Note: This field becomes available when Use Serial String is selected for Mode.</p>
Serial String	<p>Enter the Text or Binary string of bytes that must be read on the Serial Line during boot time in order to enable Command Mode. It may contain a time element to specify a required delay in milliseconds x, formed as {x}. Applies only if mode is "User Serial String". It may contain a binary character(s) of the form [x]. For example, use decimal [12] or hex [0xc].</p> <p>Note: This field becomes available when Use Serial String is selected for Mode.</p>
Echo Serial String	<p>Select Enable or Disable for Echo Serial String. Applies only if mode is "User Serial String". Select enable to echo received characters backed out on the line while looking for the serial string.</p> <p>Note: This field becomes available when Use Serial String is selected for Mode.</p>
Signon Message	<p>Enter the string of bytes to be sent to the Serial Line during boot time. It may contain a binary character(s) of the form [x]. For example, use decimal [12] or hex [0xc].</p>

Note: The following section describes the steps to view and configure Line 1 settings; these steps apply to other line instances of the device.

To Configure Line Command Mode

Using Web Manager

- ◆ To configure a specific line, click **Line** in the menu and select **Line 1 -> Configuration** ([Table 10-1](#)).
- ◆ To configure a specific line in Command Mode, click **Line** in the menu and select **Line 1 -> Command Mode** ([Table 10-2](#)).

Using the CLI

- ◆ To enter Line 1 command level: `enable -> line 1`

Using XML

- ◆ Include in your file: `<configgroup name="line" instance="1">`
- ◆ Include in your file: `<configgroup name="serial command mode" instance="1">`

Tunnel Statistics

Tunnel statistics contains data counters, error counters, connection time and connection information. Statistics are available at each individual connection and aggregated across all connections.

Note: The following section describes the steps to view Tunnel 1 statistics; these steps apply to other tunnel instances of the device.

To View Tunnel Statistics

Using Web Manager

- ◆ To view statistics for a specific tunnel, click **Tunnel** in the menu and select the **Tunnel 1 -> Statistics**.

Using the CLI

- ◆ To view Tunnel 1 statistics: enable -> tunnel 1, show statistics

Using XML

- ◆ Include in your file: <statusgroup name="tunnel" instance="1" >

Tunnel Settings

Tunneling allows serial devices to communicate over a network, without “being aware” of the devices that establish the network connection between them. Tunneling parameters are configured using the Tunnel menu and submenus. The Tunnel settings allow you to configure how the Serial-Network tunneling operates. Tunneling is available on all serial lines. The connections on one serial line are separate from those on another serial port.

Note: The following section describes the steps to view and configure Tunnel 1 settings; these steps apply to other tunnel instances of the device.

Serial Settings

These serial settings for the tunnel apply to the Serial Line interface. The Line Settings and Protocol are displayed for informational purposes and must be configured from the Line settings.

Table 10-3 Tunnel Serial Settings

Tunnel Serial Settings	Description
Line Settings	Line Settings information here is display only. Go to the section, To Configure Line Command Mode to modify these settings.
Protocol	Protocol information here is display only. Go to the section, To Configure Line Command Mode to modify these settings.

Tunnel Serial Settings (continued)	Description
DTR	Select the conditions under which the Data Terminal Ready (DTR) control signal on the serial line is asserted. Choices are: <ul style="list-style-type: none"> ◆ Unasserted ◆ TruPort = the DTR is asserted whenever either a connect or an accept mode tunnel connection is active with the Telnet Protocol RFC2217 saying that the remote DSR is asserted. ◆ Asserted while connected = the DTR is asserted whenever either a connect or an accept mode tunnel connection is active. ◆ Continuously asserted

To Configure Tunnel Serial Settings

Using Web Manager

- ◆ To configure the Serial Settings for a specific tunnel, click **Tunnel** in the menu and select **Tunnel 1 -> Serial Settings**.

Using the CLI

- ◆ To enter Tunnel 1 command level: `enable -> tunnel 1 -> serial`

Using XML

- ◆ Include in your file: `<configgroup name="tunnel serial" instance="1">`

Packing Mode

With Packing, data from the serial Line is not sent over the network immediately. Instead, data is queued and sent in segments, when either the timeout or byte threshold is reached. Packing applies to both Accept and Connect Modes.

Table 10-4 Tunnel Packing Mode Settings

Tunnel Packing Mode Settings	Description
Mode	Configure the Tunnel Packing Mode. Choices are: <ul style="list-style-type: none"> ◆ Disable = Data not packed. ◆ Timeout = data sent after timeout occurs. ◆ Send Character = data sent when the Send Character is read on the Serial Line.
Threshold	Set the threshold (byte count). If the received serial data reaches this threshold, then the data will be sent on the network. Valid range is 100 to 1450 bytes. Default is 512.
Timeout	Set the timeout value, in milliseconds, after the first character is received on the serial line, before data is sent on the network. Valid range is 1 to 30000 milliseconds. Default is 1000. This setting becomes available when the Timeout mode is selected.

Tunnel Packing Mode Settings	Description
Send Character	Enter Control Characters in any of the following forms: <ul style="list-style-type: none"> ◆ <control>J ◆ 0xA (hexadecimal) ◆ \10 (decimal) If used, the Send Character is a single printable character or a control character that, when read on the Serial Line, forces the queued data to be sent on the network immediately.
Trailing Character	Enter Control Characters in any of the following forms: <ul style="list-style-type: none"> ◆ <control>J ◆ 0xA (hexadecimal) ◆ \10 (decimal). If used, the Trailing Character is a single printable character or a control character that is injected into the outgoing data stream right after the Send Character. Disable the Trailing Character by blanking the field (setting it to <None>).

To Configure Tunnel Packing Mode Settings

Using Web Manager

- ◆ To configure the Packing Mode for a specific tunnel, click **Tunnel** in the menu and select **Tunnel 1 -> Packing Mode**.

Using the CLI

- ◆ To enter the Tunnel 1 Packing command level: `enable -> tunnel 1 -> packing`

Using XML

- ◆ Include in your file: `<configgroup name="tunnel packing" instance="1">`

Accept Mode

In Accept Mode, the PremierWave device listens (waits) for incoming connections from the network. A remote node on the network initiates the connection.

The configurable local port is the port the remote device connects to for this connection. There is no remote port or address. Supported serial lines and associated local port numbers progress sequentially in matching value. For instance, the default local port is 10001 for serial line 1 and the default local port for serial line 2 is 10002, and so on for the number of serial lines supported.

Serial data can still be received while waiting for a network connection, keeping in mind serial data buffer limitations.

Table 10-5 Tunnel Accept Mode Settings

Tunnel Accept Mode Settings	Description
Mode	Set the method used to start a tunnel in Accept mode. Choices are: <ul style="list-style-type: none"> ◆ Disable = do not accept an incoming connection. ◆ Always = accept an incoming connection (<i>default</i>). ◆ Any Character = start waiting for an incoming connection when any character is read on the serial line. ◆ Start Character = start waiting for an incoming connection when the start character for the selected tunnel is read on the serial line. ◆ Modem Control Asserted = start waiting for an incoming connection as long as the Modem Control pin (DSR) is asserted on the serial line until a connection is made. ◆ Modem Emulation = start waiting for an incoming connection when triggered by modem emulation AT commands. Connect mode must also be set to Modem Emulation.
Local Port	Set the port number for use as the network local port. The default local port number for each supported serial line number progresses sequentially in equal value so that Tunnel X: 1000X. For example: <ul style="list-style-type: none"> ◆ Tunnel 1: 10001 ◆ Tunnel 2: 10002
Protocol	Select the protocol type for use with Accept Mode: <ul style="list-style-type: none"> ◆ SSH ◆ SSL ◆ TCP (default protocol) ◆ TCP AES ◆ Telnet
Credentials	Specifies the name of the set of RSA and/or DSA certificates and keys to be used for an SSL connection.
AES Encrypt Key	Specify the text or hexadecimal advanced encryption standard (AES) key for encrypting outgoing data for a TCP AES connection.
AES Decrypt Key	Specify the text or hexadecimal AES key for decrypting incoming data for a TCP AES connection.
TCP Keep Alive Idle Time	Enter the time, in milliseconds, the PremierWave XC HSPA+ module waits during a silent TCP connection before checking if the currently connected network device is still on the network.
TCP Keep Alive Interval	Enter, in milliseconds, the amount of time between two successive keep alive probes if no acknowledgment to the previous keep alive probe is not received.
TCP Keep Alive Probes	Specify the number of TCP Keep Alive probes (after the TCP Initial Kleep Alive probe) to send before closing the connection if no response is received. Valid values are between 1 and 16. Blank the display field to restore the default.

Tunnel Accept Mode Settings (continued)	Description
Initial Send	<p>Enter the Initial Send string indicating whether it is in Text or Binary form. This Initial Send data will be sent out to the network upon connection establishment, before any data, from the Line. It may contain one or more directives in the form %<char>.</p> <p>The binary form allows square braces [] to enclose one or more character designations separated by commas. Use straight decimals up to 255 or hexadecimal numbers prefixed with 0x up to 0xFF within the square braces. To specify an open brace in binary mode, use two in a row. Example (in binary mode): AB [255, 0xFF [C [[D] results in a string containing binary values where the dots appear: AB . . C [D].</p> <p>Directives:</p> <ul style="list-style-type: none"> %i local IP address %m MAC address %n network interface name %p local port %s serial number %% %
Flush Serial	<p>Set whether the serial line data buffer is flushed upon a new network connection. Choices are:</p> <ul style="list-style-type: none"> ◆ Enabled = serial data buffer is flushed on network connection ◆ Disabled = serial data buffer is not flushed on network connection (<i>default</i>)
Block Serial	<p>Set whether Block Serial is enabled for debugging purposes. Choices are:</p> <ul style="list-style-type: none"> ◆ Enabled = if Enabled, incoming characters from the serial line will not be forwarded to the network. Instead, they will be buffered and will eventually flow off the serial line if hardware or software flow control is configured. ◆ Disabled = this is the default setting; incoming characters from the Serial Line are sent on into the network. Any buffered characters are sent first.
Block Network	<p>Set whether Block Network is enabled for debugging purposes. Choices are:</p> <ul style="list-style-type: none"> ◆ Enabled = if Enabled, incoming characters from the network will not be processed. Instead, they will be buffered and will eventually flow off the network side. ◆ Disabled = this is the default setting; incoming characters from the network will be processed. Any buffered characters are sent first.
Password	<p>Enter a password. This password can be up to 31 characters in length and must contain only alphanumeric characters and punctuation. When set, clients must send the correct password string to the unit within 30 seconds from opening network connection in order to enable data transmission. The password sent to the unit must be terminated with one of the following:</p> <ul style="list-style-type: none"> ◆ 0A (Line Feed) ◆ 00 (Null) ◆ 0D 0A (Carriage Return/Line Feed) ◆ 0D 00 (Carriage Return/Null) <p>If, Prompt for Password is set to Enabled and a password is provided, the user will be prompted for the password upon connection.</p>
Prompt for Password	<p>Select Enabled or Disabled (to enable or disable). This option will only appear if a password is specified above.</p>
Email on Connect	<p>Select an email profile number to which an email notification will be sent upon the establishment of an accept mode tunnel.</p>
Email on Disconnect	<p>Select an email profile number to which an email notification will be sent upon the disconnection of an accept mode tunnel.</p>

To Configure Tunnel Accept Mode Settings

Using Web Manager

- ◆ To configure the Accept Mode for a specific tunnel, click **Tunnel** in the menu and select **Tunnel 1 -> Accept Mode**.

Using the CLI

- ◆ To enter Tunnel 1 Accept Mode command level: `enable -> tunnel 1 -> accept`

Using XML

- ◆ Include in your file: `<configgroup name="tunnel accept" instance="1">`

Connect Mode

In Connect Mode, the PremierWave intelligent gateway unit continues to attempt an outgoing connection on the network, until established (based on which connection method is selected in the configuration described in [Table 10-6](#)). If the connection attempt fails or the connection drops, then it retries after a timeout. The remote node on the network must listen for the Connect Mode's connection.

For Connect Mode to function, it must be enabled, have a remote station (node) configured, and a remote port configured (TCP or UDP). When established, Connect Mode is always on. Enter the remote station as an IPv4 v6 address or DNS name. The PremierWave device will not make a connection unless it can resolve the address.

For Connect Mode using UDP, the PremierWave module accepts packets from any device on the network. It will send packets to the last device that sent it packets.

Note: *The port in Connect Mode is not the same port configured in Accept Mode.*

The TCP keepalive time is the time in which probes are periodically sent to the other end of the connection. This ensures the other side is still connected.

Table 10-6 Tunnel Connect Mode Settings

Tunnel Connect Mode Settings	Description
Mode	<p>Set the method to be used to attempt a connection to a remote host or device. Choices are:</p> <ul style="list-style-type: none"> ◆ Disable = an outgoing connection is never attempted. (<i>default</i>) ◆ Always = a connection is attempted until one is made. If the connection gets disconnected, the device retries until it makes a connection. ◆ Any Character = a connection is attempted when any character is read on the serial line. ◆ Start Character = a connection is attempted when the start character for the selected tunnel is read on the serial line. ◆ Modem Control Asserted = a connection is attempted as long as the Modem Control pin (DSR) is asserted, until a connection is made. ◆ Modem Emulation = a connection is attempted when triggered by modem emulation AT commands.
Local Port	Enter an alternative Local Port. The Local Port is set to <Random> by default but can be overridden. Blank the field to restore the default.

Tunnel Connect Mode Settings (continued)	Description
Host (Number)	<p>Click on the displayed information to expand it for editing. If <None> is displayed, clicking it will allow you to configure a new host. At least one Host is required to enable Connect Mode as this information is necessary to connect to that host. Once you start to edit Host 1, a box for Host 2 will show up. Editing Host 2 will cause a Host 3 box to appear. Up to 32 hosts are available.</p> <p>Complete the following fields to configure a host:</p> <ul style="list-style-type: none"> ◆ Address: enter the address for the remote host connection. Either a DNS address or an IP address maybe provided. ◆ Port: PremierWave XN Intelligent Gateway User Guide designate the TCP or UDP port on the remote host for connection. ◆ Protocol: select the desired security protocol. SSH is recommended for circumstances with high security concerns. When using SH, both the SSH server host keys and the SSH server authorized users must be configured. ◆ TCP Initial Keep Alive: specify the amount of time to wait before the first Keep Alive probe is sent to the remote host in order to keep the TCP connection up during idle transfer periods. Set to 0 to disable and blank the display field to restore the default. ◆ TCP Keep Alive Interval: specify the amount of time to wait before probing the remote host, after the initial probe, in order to keep the TCP connection up during idle transfer periods. Blank the display field to restore the default. ◆ TCP Keep Alive Probes: specify the number of TCP Keep Alive probes (after the TCP Initial Keep Alive Probe) to send before closing the connection if no response is received. Valid values are between 1 and 16. Blank the display field to restore the default. ◆ TCP User Timeout: specify the amount of time the TCP segments will be retransmitted before the connection is closed. ◆ Initial Send: enter the Initial Send string for data sent out of the network upon connection establishment (before any data from the Line). The string may contain one or more Directives of the form %<char> and can be entered in Text or Binary form. <p>Notes:</p> <ul style="list-style-type: none"> ◆ <i>If the keep alive idle time (the initial keep alive probe) expires, the user timeout is expired, and there are probes in flight, the connection will be reset. For this reason, it is recommended that if keep alive is used in conjunction with the user timeout, the keep alive timeouts be larger than the user timeout. If they are smaller, what will typically be seen is that the initial probe will be sent, then at the interval where the next probe would normally be sent, the connection will be reset, with no additional probes sent. Also note that the probe count can be disregarded in these cases: if the keep alive timers are significantly smaller than the user timeout, probes will continue to be sent for an unreachable host until the user timeout expires.</i> ◆ <i>If there is data in flight when the TCP retransmission timeout kicks in, the user timeout is checked as a limiting condition only when the timer expirations would normally be checked during RTO handling. In other words, the user timeout will not be an exact limit; in practice, it will always take somewhat longer for the connection to be closed. The longer the user timeout is, the more likely it will expire between exponentially slower retransmissions, and the connection will not experience an error until the next retransmission timeout is checked. Also note that the user timeout expiration during retransmission returns an error to the application; it does not automatically reset the connection as happens with keep alive timeout. It is up to the application (e.g., tunneling) to close the connection (this happens almost immediately with tunneling).</i>

Tunnel Connect Mode Settings (continued)	Description
Reconnect Timer	Set the value of the reconnect timeout (in milliseconds) for outgoing connections established by the device. Valid range is 1 to 65535 milliseconds. Default is 15000.
Flush Serial Data	Set whether the serial Line data buffer is flushed upon a new network connection. Choices are: <ul style="list-style-type: none"> ◆ Enabled = serial data buffer is flushed on network connection ◆ Disabled = serial data buffer is not flushed on network connection (<i>default</i>)
Block Serial	Set whether Block Serial is enabled for debugging purposes. Choices are: <ul style="list-style-type: none"> ◆ Enabled = If Enabled, incoming characters from the Serial Line will not be forwarded to the network. Instead, they will be buffered and will eventually flow off the Serial Line if hardware or software flow control is configured. ◆ Disabled = this is the default setting; incoming characters from the Serial Line are sent on into the network. Any buffered characters are sent first.
Block Network	Set whether Block Network is enabled for debugging purposes. Choices are: <ul style="list-style-type: none"> ◆ Enabled = If Enabled, incoming characters from the network will not be forwarded to the Serial Line. Instead, they will be buffered and will eventually flow off the network side. ◆ Disabled = this is the default setting; incoming characters from the network are sent on into the Serial Line. Any buffered characters are sent first.
Email on Connect	Select an email profile number to which an email notification will be sent upon the establishment of an accept mode tunnel.
Email on Disconnect	Select an email profile number to which an email notification will be sent upon the disconnection of an accept mode tunnel.

To Configure Tunnel Connect Mode Settings

Using Web Manager

- ◆ To configure the Connect Mode for a specific tunnel, click **Tunnel** in the menu and select **Tunnel 1 -> Connect Mode**.

Using the CLI

- ◆ To enter the Tunnel 1 Connect Mode command level: `enable -> tunnel 1 -> connect`

Using XML

- ◆ Include in your file: `<configgroup name="tunnel connect" instance="1">`

Connecting Multiple Hosts

If more than one host is configured, a **Host Mode** option appears. Host Mode controls how multiple hosts will be accessed. For the device, the Connect Mode supports up to 32 hosts. Hosts may be accessed sequentially or simultaneously:

- ◆ **Sequential** – Sequential host lists establish a prioritized list of tunnels. The host specified as Host 1 will be attempted first. If that fails, it will proceed to Host 2, 3, etc, in the order they are specified. When a connection drops, the cycle starts again with Host 1 and proceeds in order. Establishing the host order is accomplished with host list promotion (see [Host List Promotion on page 79](#)). Sequential is the default Host Mode.

- ◆ **Simultaneous** – A tunnel will connect to all hosts accepting a connection. Simultaneous connections occur at the same time to all listed hosts. The device can support a maximum of 64 total aggregate connections.

Host List Promotion

This feature allows Host IP promotion of individual hosts in the overall sequence.

To promote a specific Host:

1. Click the  icon in the desired Host field, for example Host 2 and Host 3.
2. The selected Host(s) exchanges its place with the Host above it.
3. Click **Submit**. The hosts change sequence.

Disconnect Mode

Specifies the optional conditions for disconnecting any Accept Mode or Connect Mode connection that may be established. If any of these conditions are selected but do not occur and the network disconnects to the device, a Connect Mode connection will attempt to reconnect. However, if none of these conditions are selected, a closure from the network is taken as a disconnect.

Table 10-7 Tunnel Disconnect Mode Settings

Tunnel Disconnect Mode Settings	Description
Stop Character	Enter the Stop Character which, when received on the Serial Line, disconnects the tunnel. The Stop Character may be designated as a single printable character or as a control character. Control characters may be input in any of the following forms: <control>J or 0xA(hexadecimal) or \10 (decimal). Disable the Stop Character by blanking the field to set it to <None>.
Modem Control	Set whether Modem Control enables disconnect when the Modem Control pin is not asserted on the Serial Line. Choices are: <ul style="list-style-type: none"> ◆ Enabled ◆ Disabled (default)
Timeout	Enter the number of milliseconds a tunnel may be idle before disconnection. The value of zero disables the idle timeout.
Flush Serial Data	Set whether to flush the Serial Line when the Tunnel is disconnected. Choices are: <ul style="list-style-type: none"> ◆ Enabled ◆ Disabled (default)

To Configure Tunnel Disconnect Mode Settings

Using Web Manager

- ◆ To configure the Disconnect Mode for a specific tunnel, click **Tunnel** in the menu and select **Tunnel 1 -> Disconnect Mode**.

Using the CLI

- ◆ To enter the Tunnel 1 Disconnect command level: `enable -> tunnel 1 -> disconnect`

Using XML

- ◆ Include in your file: `<configgroup name="tunnel disconnect" instance="1">`

Modem Emulation

Some older equipment is designed to attach to a serial port and dial into a network with a modem. This equipment uses AT commands to control the connection. For compatibility with these older devices on modern networks, the PremierWave device mimics the behavior of the modem.

Table 10-8 Tunnel Modem Emulation Settings

Tunnel Modem Emulation Settings	Description
Echo Pluses	Set whether the pluses will be echoed back during a "pause +++ pause" escape sequence on the Serial Line. Choices are: <ul style="list-style-type: none"> ◆ Enabled ◆ Disabled (default)
Echo Commands	Set whether characters read on the Serial Line will be echoed, while the Line is in Modem Command Mode. Choices are: <ul style="list-style-type: none"> ◆ Enabled ◆ Disabled (default)
Verbose Response	Set whether Modem Response Codes are sent out on the Serial Line. Choices are: <ul style="list-style-type: none"> ◆ Enabled ◆ Disabled (default)
Response Type	Select a representation for the Modem Response Codes sent out on the Serial Line. Choices are: <ul style="list-style-type: none"> ◆ Text (ATV1) (default) ◆ Numeric (ATV0)
Error Unknown Commands	Set whether the Error Unknown Commands is enabled (ATU0) and ERROR is returned on the Serial Line for unrecognized AT commands. Otherwise (ATU1) OK is returned for unrecognized AT commands. Choices are: <ul style="list-style-type: none"> ◆ Enabled ◆ Disabled (default)
Incoming Connection	Set how and if requests are answered after an incoming RING (ATS0=2). Choices are: <ul style="list-style-type: none"> ◆ Disabled (default) ◆ Automatic ◆ Manual
Connect String	Enter the customized Connect String sent to the Serial Line with the Connect Modem Response Code.
Display Remote IP	Set whether the Display Remote IP is enabled so that the incoming RING sent on the Serial Line is followed by the IP address of the caller. Choices are: <ul style="list-style-type: none"> ◆ Enabled ◆ Disabled (default)

To Configure Tunnel Modem Emulation Settings

Using Web Manager

To configure the Modem Emulation for a specific tunnel, click **Tunnel** in the menu and select **Tunnel 1 -> Modem Emulation**.

Using the CLI

- ◆ To enter the Tunnel 1 Modem command level: `enable -> tunnel 1 -> modem`

Using XML

- ◆ Include in your file: `<configgroup name="tunnel modem" instance="1">`

11: Terminal and Host Settings

Predefined connections are available via Telnet, SSH, or a serial port. A user can choose one of the presented options and the device automatically makes the predefined connection.

Either the Telnet, SSH, or serial port connection can present the CLI or the Login Connect Menu. By default, the CLI is presented when the device is accessed. When configured to present the Login Connect Menu, the hosts configured via the Host selections, and named serial lines are presented.

Terminal Settings

You can configure whether each serial line or the Telnet/SSH server presents a CLI or a Login Connect menu when a connection is made.

Table 11-1 Terminal on Network and Line Settings

Terminal on Network and Line Settings	Description
Terminal Type	Enter text to describe the type of terminal. The text will be sent to a host via IAC. <i>Note:</i> IAC means, "interpret as command." It is a way to send commands over the network such as send break or start echoing . IAC is only supported in Telnet.
Login Connect Menu	Select the interface to display when the user logs in. Choices are: <ul style="list-style-type: none"> ◆ Enabled = shows the Login Connect Menu. ◆ Disabled = shows the CLI (default)
Exit Connect Menu	Select whether to display a choice for the user to exit the Login Connect Menu and reach the CLI. Choices are: <ul style="list-style-type: none"> ◆ Enabled = a choice allows the user to exit to the CLI. ◆ Disabled = there is no exit to the CLI (default)
Send Break	Enter a Send Break control character, e.g., <control> Y, or blank to disable. When the Send Break control character is received from the network on its way to the serial line, it is not sent to the line; instead, the line output is forced to be inactive (the break condition). <i>Note:</i> This configuration option is only available for Line Terminals.
Break Duration	Enter how long the break should last in milliseconds, up to 10000. Default is 500. <i>Note:</i> This configuration option is only available for Line Terminals.
Echo	Select whether to enable echo: <ul style="list-style-type: none"> ◆ Enabled ◆ Disabled <i>Note:</i> Applies only to Connect Mode Telnet connections, not to Accept Mode. Only disable Echo if your terminal echoes, in which case you will see double of each character typed. Default is enabled.

To Configure the Terminal Network Connection

Using Web Manager

- ◆ To configure the Terminal on Network, click **Terminal** on the menu and select **Network -> Configuration**.

Using the CLI

- ◆ To enter the Terminal Network command level: `enable -> config -> terminal network`

Using XML

- ◆ Include in your file: `<configgroup name="terminal" instance="network">`

To Configure the Terminal Line Connection

Note: The following section describes the steps to view and configure Terminal 1 settings; these steps apply to other terminal instances of the device.

Using Web Manager

- ◆ To configure a particular Terminal Line, click **Terminal** on the menu and select **Line 1 -> Configuration**.

Using the CLI

- ◆ To enter the Terminal Line command level: `enable -> config -> terminal 1`

Using XML

- ◆ Include in your file: `<configgroup name="terminal" instance="1">`

Host Configuration

Table 11-2 Host Configuration

Host Settings	Description
Name	Enter a name for the host. This name appears on the Login Connect Menu. To leave a host out of the menu, leave this field blank.
Protocol	Select the protocol to use to connect to the host. Choices are: <ul style="list-style-type: none"> ◆ Telnet ◆ SSH <p>Note: SSH keys must be loaded or created on the SSH page for the SSH protocol to work.</p>

Host Settings	Description
SSH Username	Appears if you selected SSH as the protocol. Enter a username to select a pre-configured Username/Password/Key (configured on the SSH: Client Users page), or leave it blank to be prompted for a username and password at connect time. <i>Note: This configuration option is only available when SSH is selected for Protocol.</i>
Remote Address	Enter an IP address for the host to which the device will connect.
Remote Port	Enter the port on the host to which the device will connect.

To Configure Host Settings

Note: The following section describes the steps to view and configure Host 1 settings; these steps apply to other host instances of the device.

Using Web Manager

- ◆ To configure a particular Host, click **Host** on the menu and select **Host 1 -> Configuration**.

Using the CLI

- ◆ To enter the Host command level: `enable -> config -> host 1`

Using XML

- ◆ Include in your file: `<configgroup name="host" instance="1">`

12: Network Services

DNS Settings

This section describes the active run-time settings for the domain name system (DNS) protocol. The primary and secondary DNS addresses come from the active interface. The static addresses from the Network Interface configuration settings may be overridden by DHCP.

Note: The blue text in the XML command strings of this chapter are to be replaced with a user-specified name.

Table 12-1 DNS Settings

Setting / Field	Description
Lookup	Perform one of the following: <ul style="list-style-type: none">◆ Enter an IP address, and perform a reverse Lookup to locate the hostname for that IP address◆ Enter a hostname, and perform a forward Lookup to locate the corresponding IP address

To View or Configure DNS Settings:

Using Web Manager

- ◆ To view DNS current status, click **DNS** in the menu.
- ◆ To lookup DNS name or IP address, click **DNS** in the menu to access the **Lookup** field.

Note: To configure DNS for cases where it is not supplied by a protocol, click **Network** in the menu and select **Interface -> Configuration**.

Using the CLI

- ◆ To enter the DNS command level: `enable -> dns`

Using XML

- ◆ Include in your file: `<configgroup name="interface" instance="eth0">`

FTP Settings

The FTP protocol can be used to upload and download user files, and upgrade the PremierWave XC HSPA+ intelligent gateway firmware. A configurable option is provided to enable or disable access via this protocol.

Table 12-2 FTP Settings

FTP Settings	Description
State	Select to enable or disable the FTP server: <ul style="list-style-type: none"> ◆ Enabled (default) ◆ Disabled

To Configure FTP Settings

Using Web Manager

- ◆ To configure FTP and view FTP statistics, click **FTP** in the menu.

Using the CLI

- ◆ To enter the FTP command level: `enable -> config -> ftp`

Using XML

- ◆ Include in your file: `<configgroup name="ftp server">`

Syslog Settings

The Syslog information shows the current configuration and statistics of the syslog. Here you can configure the syslog host and the severity of the events to log.

Note: *The system log is always saved to local storage, but it is not retained through reboots unless diagnostics logging to the file system is enabled. Saving the system log to a server that supports remote logging services (see RFC 3164) allows the administrator to save the complete system log history. The default port is 514.*

Table 12-3 Syslog Settings

Syslog Settings	Description
State	Select to enable or disable the syslog: <ul style="list-style-type: none"> ◆ Enabled ◆ Disabled (default)
Host	Enter the IP address of the remote server to which system logs are sent for storage.
Remote Port	Enter the number of the port on the remote server that supports logging services. The default is 514.

Syslog Settings (continued)	Description
Severity Log Level	Specify the minimum level of system message the PremierWave device should log by selecting from the drop-down menu. This setting applies to all syslog facilities. The drop-down list in the Web Manager is in descending order of severity (e.g., Emergency is more severe than Alert.)

To View or Configure Syslog Settings

Using Web Manager

- ◆ To configure the Syslog and view current Syslog status, click **Syslog** in the menu.

Using the CLI

- ◆ To enter the Syslog command level: `enable -> config -> syslog`

Using XML

- ◆ Include in your file: `<configgroup name="syslog">`

HTTP Settings

Hypertext Transfer Protocol (HTTP) is the transport protocol for communicating hypertext documents on the Internet. HTTP defines how messages are formatted and transmitted. It also defines the actions web servers and browsers should take in response to different commands. HTTP Authentication enables the requirement of usernames and passwords for access to the device.

Table 12-4 HTTP Settings

HTTP Settings	Description
State	Select to enable or disable the HTTP server: <ul style="list-style-type: none"> ◆ Enabled (default) ◆ Disabled
Port	Enter the port for the HTTP server to use. The default is 80 .
Secure Port	Enter the port for the HTTPS server to use. The default is 443 . The HTTP server only listens on the HTTPS Port when an SSL certificate is configured.
Secure Protocols	Select to enable or disable the following protocols: <ul style="list-style-type: none"> ◆ SSL3 = Secure Sockets Layer version 3 ◆ TLS1.0 = Transport Layer Security version 1.0. TLS 1.0 is the successor of SSL3 as defined by the IETF. ◆ TLS1.1 = Transport Layer Security version 1.1 The protocols are enabled by default. <p><i>Note: A server certificate and associated private key need to be installed in the SSL configuration section to use HTTPS.</i></p>
Secure Credentials	Specify the name of the set of RSA and/or DSA certificates and keys to be used for the secure connection.

HTTP Settings (continued)	Description
Max Timeout	Enter the maximum time for the HTTP server to wait when receiving a request. This prevents Denial-of-Service (DoS) attacks. The default is 10 seconds.
Max Bytes	Enter the maximum number of bytes the HTTP server accepts when receiving a request. The default is 40 KB (this prevents DoS attacks). Note: You may need to increase this number in some cases where the browser is sending data aggressively within TCP Windows size limit, when file (including firmware upgrade) is uploaded from webpage.
Logging State	Select to enable or disable HTTP server logging: <ul style="list-style-type: none"> ◆ Enabled (default) ◆ Disabled
Max Log Entries	Set the maximum number of HTTP server log entries. Only the last Max Log Entries are cached and viewable.
Log Format	Set the log format string for the HTTP server. Follow these Log Format rules: <ul style="list-style-type: none"> ◆ %a - remote IP address (could be a proxy) ◆ %b - bytes sent excluding headers ◆ %B - bytes sent excluding headers (0 = '-') ◆ %h - remote host (same as '%a') ◆ %{h}i - header contents from request (h = header string) ◆ %m - request method ◆ %p - ephemeral local port value used for request ◆ %q - query string (prepend with '?' or empty '-') ◆ %t - timestamp HH:MM:SS (same as Apache '%(%H:%M:%S)t' or '%(%T)t') ◆ %u - remote user (could be bogus for 401 status) ◆ %U - URL path info ◆ %r - first line of request (same as '%m %U%q <version>') ◆ %s - return status
Authentication Timeout	The timeout period applies if the selected authentication type is either Digest or SSL/Digest . After this period of inactivity, the client must authenticate again.

To Configure HTTP Settings

Using Web Manager

- ◆ To view HTTP statistics, click **HTTP** in the menu and select **Statistics**.
- ◆ To configure HTTP settings, click **HTTP** in the menu and select **Configuration**.

Using the CLI

- ◆ To enter the HTTP command level: `enable -> config -> http`

Using XML

- ◆ Include in your file: `<configgroup name="http server">`

Table 12-5 HTTP Authentication Settings

HTTP Authentication Settings	Description
URI	Enter the Uniform Resource Identifier (URI). <i>Note: The URI must begin with '/' to refer to the filesystem.</i>
Auth Type	Select the authentication type: <ul style="list-style-type: none"> ◆ None = no authentication is necessary. ◆ Basic = encodes passwords using Base64. ◆ Digest = encodes passwords using MD5. ◆ SSL = can only be accessed over SSL (no password is required). ◆ SSL/Basic = is accessible only over SSL and encodes passwords using Base64. ◆ SSL/Digest = is accessible only over SSL and encodes passwords using MD5. <i>Note: When changing the parameters of Digest or SSL Digest authentication, it is often best to close and reopen the browser to ensure it does not attempt to use cached authentication information.</i>
Submit (button)	Click the Submit button after entering the HTTP authentication information.
Delete (button)	Click the Delete button to delete the HTTP authentication information.

To Configure HTTP Authentication

Using Web Manager

- ◆ To configure HTTP Authentication, click **HTTP** in the menu and select **Authentication**.

Using the CLI

- ◆ To enter the HTTP command level: enable -> config -> http

Using XML

- ◆ Include in your file:

```
<configgroup name="http authentication uri" instance="uri name">
```

RSS Settings

Really Simple Syndication (RSS) (sometimes referred to as Rich Site Summary) is a method of feeding online content to Web users. Instead of actively searching for configuration changes, RSS feeds permit viewing only relevant and new information regarding changes made via an RSS publisher. The RSS feeds may also be stored to the file system `cfg_log.txt` file.

Table 12-6 RSS Settings

RSS Settings	Description
RSS Feed	Select On or Off for RSS feeds to an RSS publisher. The default setting is off.
Persistent	Select On or Off for RSS feed to be written to a file (<code>cfg_log.txt</code>) and to be available across reboots. The default setting is off.
Max Entries	Set the maximum number of log entries. Only the last Max Entries are cached and viewable.

RSS Settings	Description
View	Click the button to view RSS feeds.
Clear	Click the button to clear RSS feed data.

To Configure RSS Settings

Using Web Manager

- ◆ To configure RSS and view current RSS statistics, click **RSS** in the menu.

Using the CLI

- ◆ To enter the RSS command level: `enable -> config -> rss`

Using XML

- ◆ Include in your file: `<configgroup name="rss">`

SNMP Settings

Simple Network Management Protocol (SNMP) settings may be viewed and configured in this section.

Table 12-7 SNMP Settings

SNMP Settings	Description
State	Select to enable or disable the SNMP agent state.
Version	Select the SNMP version used by the SNMP agent.
Read Community	Specify the read community used by the agent (defaults to public community).
Write Community	Specify the write community used by the agent (defaults to private community).
System Contact	Specify the system contact.
System Name	Update the system name, as necessary. The default system name is "".
System Description	Update the system description, as necessary. The default system information includes the manufacturer name, model name, version and the serial number of the device.
System Location	Specify a system location for the SNMP setting.
Lantronix MIB File	Click the Lantronix MIB file name to save and load it into the MIB browser and trap receiver. This is the base MIB file for Lantronix products. Load or compile this file first.
MIB File	Click the MIB file name to save and load it into the MIB browser and trap receiver. This is the product specific MIB file. Load or compile this after the Lantronix MIB File.

To Configure SNMP Settings

Using Web Manager

- ◆ To configure SNMP, click **SNMP** in the menu.

Using the CLI

- ◆ To enter the SNMP command level: `enable -> config -> snmp`

Using XML

- ◆ Include in your file: `<configgroup name="snmp">`

Discovery

The current statistics and configuration options for device discovery, including UPnP query port are available for the PremierWave XC HSPA+ intelligent gateway.

Table 12-8 Discovery Settings

Discovery	Description
Query Port Server State	Select to enable or disable the query port server from responding to autodiscovery messages on port 0x77FE.
UPnP Server State	Select to enable or disable the UPnP server from discovering devices in Windows network places.
UPnP Server Port	Update the UPnP server port. Leaving this field blank will restore the default settings.

To Configure Discovery

Note: If you are utilizing Windows XP, make sure to select **UPnP User Interface** under **Windows Components > Networking Services > Details** before setting up the PremierWave device to utilize Discovery.

Using Web Manager

- ◆ To access the area with options to configure discovery and view current discovery statistics, click **Discovery** in the menu.

Using the CLI

- ◆ To enter the command level: `enable -> config -> discovery`

Using XML

- ◆ Include in your file: `<configgroup name="discovery">`

SMTP Settings

Table 12-9 SMTP Settings

SMTP Settings	Description
From Address	Enter the From Address here. This is an email address and is required. If you wish to direct outbound email messages through a mail server, put your client email address here.
Server Address	Enter the Server Address to direct outbound email messages through a mail server.
Server Port	Enter the SMTP server port number. The default is 25
Username	Enter a Username to direct outbound email messages through a mail server.
Password	Enter a Password to direct outbound email messages through a mail server.
Overriding Domain	Enter the domain name to override the current domain name in EHLO (Extended Hello).

To Configure SMTP Settings

Using Web Manager

- ◆ To configure SMTP protocol settings, click **SMTP** in the menu.

Using the CLI

- ◆ To enter the command level: `enable -> config -> smtp`

Using XML

- ◆ Include in your file: `<configgroup name="smtp">`

Email Settings

View and configure email alerts relating to events occurring within the system.

Table 12-10 Email Configuration

Email – Configuration Settings	Description
From	Click the Configure SMTP link to configure SMTP: SMTP Settings (on page 92) .
To	Enter the email address to which the email alerts will be sent. Multiple addresses are separated by semicolon (;). Required field if email is to be sent.
CC	Enter the email address to which the email alerts will be copied. Multiple addresses are separated by semicolon (;).
Reply To	Enter the email address to list in the Reply-To field of the email alert.
Subject	Enter the subject for the email alert. <i>Note: Emails sent as a result of an alarm will display the name of the alarm in the subject of the email, overriding the email subject configured in this field.</i>

Email – Configuration Settings (continued)	Description
Message File	Enter the path of the file to send with the email alert. This file appears within the message body of the email, not as an attachment.
Priority	Select the priority level for the email alert: <ul style="list-style-type: none"> ◆ Urgent ◆ High ◆ Normal ◆ Low ◆ Very Low

To View, Configure, and Send Email

Note: The following section describes the steps to view and configure Email 1 settings; these steps apply to other emails available for the device.

Using Web Manager

- ◆ To view Email statistics, click **Email** in the menu and select **Email 1 -> Statistics**.
- ◆ To configure basic Email settings, click **Email** in the menu and select **Email 1 -> Configuration**.
- ◆ To send an email, click **Email** in the menu and select **Email 1 -> Send Email**.

Using the CLI

- ◆ To enter Email command level: `enable -> email 1`

Using XML

- ◆ Include in your file: `<configgroup name="email" instance="1">`

13: SMS Settings

SMS settings allows the user to view and configure inbound/outbound SMS to/from the device. Adding a number to the SMS whitelist allows the SMS from the number to trigger one or more control functions on the device. The following control functions are available:

- ◆ **Shoulder-Tap** function can be used to bring up the cellular connection. Since this function has only one action ("on"), the message text should be "shoulder-tap".
- ◆ **Relay Control** function can be used to turn a relay on or off. To turn a relay on, the text should be "relay 1 on", or on a device with a single relay, just "relay on". To turn a relay off, the text should be "relay 1 off", or on a device with a single relay, just "relay off".

Inbound SMS

Table 13-1 Inbound SMS Settings

Inbound SMS Settings	Description
Delete	Click beside an existing SMS Sender Configuration to delete it.
Number	View the sender number of an existing SMS sender.
Shoulder Tap	Check to allow incoming SMS with content containing 'shoulder tap' from this sender to start the cellular interface.
Relay Control	Check to allow incoming SMS with content containing 'relay N On/Off' from this sender to open and close the device relays.

Table 13-2 Adding a New SMS Settings

Inbound SMS Settings	Description
Number	Enter the new SMS Sender number to be added.
Whitelists	Check to select a specific whitelist to be associated with newly added SMS sender number: <ul style="list-style-type: none"> ◆ Shoulder Tap ◆ Relay Control
Add (button)	Click the Add button after entering the new SMS sender information.

Outbound SMS

Table 13-3 Outbound SMS Settings

Outbound SMS Settings	Description
Message Center Default Number	Displays the Message Center number as configured in the SIM.
Message Center Override Number	Enter a number to override the existing Message Center number.
Band	Select a band from the drop-down menu: <ul style="list-style-type: none"> ◆ Circuit Switched only ◆ Packet Domain only ◆ Circuit Switched preferred ◆ Packet Domain preferred <p>Note: Check with your service provider for supported bands.</p>

Outbound SMS Settings	Description
Number	Enter the Recipient Number.
Encoding	Select the SMS encoding mode: <ul style="list-style-type: none"> ◆ ASCII 7-bit ◆ ASCII 8-bit ◆ UCS-2
Message	Enter the SMS message content. <i>Note: Entering more than 70 characters in the SMS message may cause splitting of text messages.</i>
Remaining Characters	Displays remaining characters.

To Configure Inbound SMS

Using Web Manager

- ◆ To view and configure inbound SMS, click **SMS** in the menu and select **Inbound**.

Using the CLI

- ◆ To enter the command level: enable -> configure -> sms -> inbound

Using the XML

- ◆ Include in your file: <configgroup name="sms inbound">

To Configure Outbound SMS

Using Web Manager

- ◆ To view and configure outbound SMS, click **SMS** in the menu and select **Outbound**

Using the CLI

- ◆ To enter the command level: enable -> configure -> sms -> outbound

Using the XML

- ◆ Include in your file: <configgroup name="sms outbound">

14: Updating Firmware

Obtaining Firmware

Obtain the most up-to-date firmware and release notes for the unit from the Lantronix Web site (www.lantronix.com/support/downloads/) or by using anonymous FTP (<ftp://ftp.lantronix.com/>).

Loading New Firmware through Web Manager

Upload the firmware using the device web manager System page.

To upload new firmware:

1. Select **System** in the menu bar. The System page appears.

Figure 14-1 Uploading New Firmware

PremierWave[®] XC HSPA+ LANTRONIX[®]

Status **System** [\[Logout\]](#)

Action

Applications

Cellular

CLI

Clock

Diagnostics

Digital Input

Discovery

DNS

DDNS

Email

Filesystem

FTP

Gateway

GRE

Host

HTTP

Line

Network

Protocol Stack

Relay

RSS

SMS

SMTP

SNMP

SSH

SSL

Syslog

System

Terminal

Tunnel

VPN

XML

System

Reboot Schedule

Configuration

State:	<input type="radio"/> Enabled <input checked="" type="radio"/> Disabled
Current date and time:	Mon Jan 08 12:30:11 UTC 2007
Schedule:	Daily ▾
Time (24 hour):	Hour: 00 ▾ Min: 30 ▾

Reboot Device

Restore Factory Defaults

Upload New Firmware

No file chosen

Name

Short Name:

Long Name:

Current Configuration

Firmware Version:	8.0.0.0R13
Short Name:	premierwave_xc_hspa
Long Name:	Lantronix PremierWave XC HSPA+

Use a reboot schedule to automatically reboot the device at specified time or interval.

WARNING: Use extreme caution when using scheduled reboots. The device will automatically reboot as scheduled. Any configuration changes not saved to Flash will be lost. CLI/WEB sessions and network traffic will be interrupted. To avoid frequent reboots, device will not be rebooted if it was started or configured less than 30 minutes from the current date/time.

When the device is rebooted, your browser should be refreshed and redirected to the main status page after 30 seconds. Note that the redirect will not work as expected if the IP Address of the device changes after reboot.

After setting the configuration back to the factory defaults, the device will automatically be rebooted.

WARNING: Be careful not to power off or reset the device while uploading new firmware. Do not initiate new connections to or from the device as it may interrupt the upgrade process. Once the upload has completed and the new firmware has been verified and flashed, the device will automatically be rebooted.

Copyright © Lantronix, Inc. 2007-2017. All rights reserved.

2. Click **Browse** (under the **Upload New Firmware** heading) to browse to the firmware file.
3. Select the file and click **Open**.
4. Click **Upload** to install the firmware on the PremierWave XC HSPA+ unit.
5. Click **OK** in the confirmation popup which appears. The firmware will be installed and the device will automatically reboot afterwards.
6. Close and reopen the web manager internet browser to view the device's updated web pages.

Note: You may need to increase HTTP Max Bytes in some cases where the browser is sending data aggressively within TCP Windows size limit when file (including firmware upgrade) is uploaded from webpage.

Loading New Firmware through FTP

Firmware may be updated by sending the file to the PremierWave XC HSPA+ intelligent gateway over an FTP connection. The destination file name on the PremierWave XC HSPA+ unit must have a "firmware.rom" type of format. The device will reboot upon successful completion of the firmware upgrade.

Example FTP session:

```
$ ftp 192.168.10.127
Connected to 192.168.10.127.
220 (vsFTPd 2.0.7)
Name (192.168.10.127:user): admin
331 Please specify the password.
Password:
230 Login successful.
Remote system type is UNIX.
Using binary mode to transfer files.
ftp> put premierwave_xc_hspa_8_0_0_0R15
200 PORT command successful. Consider using PASV.
150 Ok to send data.
226 File receive OK.
9308164 bytes sent in 3.05 seconds (3047859 bytes/s)
ftp> quit
221 Goodbye.
```

15: Security Settings

The PremierWave XC HSPA+ device supports Secure Shell (SSH) and Secure Sockets Layer (SSL). SSH is a network protocol for securely accessing a remote device. SSH provides a secure, encrypted communication channel between two hosts over a network. It provides authentication and message integrity services.

Secure Sockets Layer (SSL) is a protocol that manages data transmission security over the Internet. It uses digital certificates for authentication and cryptography against eavesdropping and tampering. It provides encryption and message integrity services. SSL is widely used for secure communication to a web server. SSL uses certificates and private keys.

Note: *The device supports SSLv3 and its successors, TLS1.0 and TLS1.1. An incoming SSLv2 connection attempt is answered with an SSLv3 response. If the initiator also supports SSLv3, SSLv3 handles the rest of the connection.*

Public Key Infrastructure

Public key infrastructure (PKI) is based on an encryption technique that uses two keys: a public key and private key. Public keys can be used to encrypt messages which can only be decrypted using the private key. This technique is referred to as asymmetric encryption, as opposed to symmetric encryption, in which a single secret key is used by both parties.

TLS (SSL)

Transport Layer Security (TLS) and its predecessor, Secure Sockets Layer (SSL), use asymmetric encryption for authentication. In some scenarios, only a server needs to be authenticated, in others both client and server authenticate each other. Once authentication is established, clients and servers use asymmetric encryption to exchange a secret key. Communication then proceeds with symmetric encryption, using this key.

SSH and some authentication methods on the PremierWave XC HSPA+ intelligent gateway make use of SSL. The PremierWave XC HSPA+ unit supports SSLv2, SSLv3, and TLS1.0.

TLS/SSL application hosts use separate digital certificates as a basis for authentication in both directions: to prove their own identity to the other party, and to verify the identity of the other party. In proving its own authenticity, the PremierWave XC HSPA+ intelligent gateway will use its own "personal" certificate. In verifying the authenticity of the other party, the PremierWave XC HSPA+ device will use a "trusted authority" certificate.

In short:

- ◆ When using EAP-TLS, the PremierWave XC HSPA+ intelligent gateway needs a personal certificate with matching private key to identify itself and sign its messages.
- ◆ When using EAP-TLS, EAP-TTLS or PEAP, the PremierWave XC HSPA+ unit needs the authority certificate(s) that can authenticate those it wishes to communicate with.

Digital Certificates

The goal of a certificate is to authenticate its sender. It is analogous to a paper document that contains personal identification information and is signed by an authority, for example a notary or government agency. With digital certificates, a cryptographic key is used to create a unique digital signature.

Trusted Authorities

A private key is used by a trusted certificate authority (CA) to create a unique digital signature. Along with this private key is a certificate of authority, containing a matching public key that can be used to verify the authority's signature but not re-create it.

A chain of signed certificates, anchored by a root CA, can be used to establish a sender's authenticity. Each link in the chain is certified by a signed certificate from the previous link, with the exception of the root CA. This way, trust is transferred along the chain, from the root CA through any number of intermediate authorities, ultimately to the agent that needs to prove its authenticity.

Obtaining Certificates

Signed certificates are typically obtained from well-known CAs, such as VeriSign, Inc. This is done by submitting a certificate request for a CA, typically for a fee. The CA will sign the certificate request, producing a certificate/key combo: the certificate contains the identity of the owner and the public key, and the private key is available separately for use by the owner.

As an alternative to acquiring a signed certificate from a CA, you can act as your own CA and create self-signed certificates. This is often done for testing scenarios, and sometimes for closed environments where the expense of a CA-signed root certificate is not necessary.

Self-Signed Certificates

A few utilities exist to generate self-signed certificates or sign certificate requests. The PremierWave XC HSPA+ intelligent gateway also has the ability to generate its own self-signed certificate/key combo. You can use XML to export the certificate in PEM format, but you cannot export the key. Hence, the internal certificate generator can only be used for certificates that are to identify that particular PremierWave XC HSPA+ module.

Certificate Formats

Certificates and private keys can be stored in several file formats. Best known are PKCS12, DER and PEM. Certificate and key can be in the same file or in separate files. Additionally, the key can be either be encrypted with a password or left in the clear. However, PremierWave XC HSPA+ intelligent gateway currently only accepts separate PEM files, with the key unencrypted.

Several utilities exist to convert between the formats.

OpenSSL

OpenSSL is a widely used open source set of SSL related command line utilities. It can act as server or client. It can also generate or sign certificate requests, and can convert from and to several different of formats.

OpenSSL is available in binary form for Linux and Windows.

To generate a self-signed RSA certificate/key combo:

```
openssl req -x509 -nodes -days 365 -newkey rsa:1024 -keyout mp_key.pem -
out mp_cert.pem
```

See www.openssl.org or www.madboa.com/geek/openssl for more information.

Note: *Signing other certificate requests is also possible with OpenSSL but the details of this process are outside the scope of this document.*

SSH Settings

SSH is a network protocol for securely accessing a remote device over an encrypted channel. This protocol manages the security of internet data transmission between two hosts over a network by providing encryption, authentication, and message integrity services.

Configuration is required when the PremierWave XC HSPA+ device is either (1) the SSH server or (2) an SSH client.. The SSH server is used by the CLI (Command Mode) and for tunneling in Accept Mode. The SSH client is for tunneling in Connect Mode.

To configure the PremierWave XC HSPA+ intelligent gateway as an SSH server, there are two requirements:

- ◆ **Defined Host Keys:** both private and public keys are required. These keys are used for the Diffie-Hellman key exchange (used for the underlying encryption protocol).
- ◆ **Defined Users:** these users are permitted to connect to the PremierWave XC HSPA+ device SSH server.

SSH Server Host Keys

The SSH Server Host Keys are used by all applications that play the role of an SSH Server. Specifically Tunneling in Accept Mode. These keys can be created elsewhere and uploaded to the device or automatically generated on the device.

If uploading existing keys, take care to ensure the Private Key will not be compromised in transit. This implies the data is uploaded over some kind of secure private network.

Note: *Some SSH Clients require RSA Host Keys to be at least 1024 bits in size.*

Table 15-1 SSH Server Host Keys

SSH Settings	Description
Private Key	Click Choose File to browse to and select the existing private key you want to upload. In Web Manager, you can also browse to the private key to be uploaded. Be sure the private key will not be compromised in transit. This implies the data is uploaded over some kind of secure private network.

SSH Settings (continued)	Description
Public Key	Click Choose File to browse to and select the existing public key you want to upload. In Web Manager, you can also browse to the public key to be uploaded.
Key Type	Select a key type to use for the new key: <ul style="list-style-type: none"> ◆ RSA ◆ DSA
Bit Size	Select a bit length for the new key: <ul style="list-style-type: none"> ◆ 512 ◆ 768 ◆ 1024
Submit (key)	Click the Submit button after setting the information for Upload Keys or Create New Keys .

Note: SSH Keys from other programs may be converted to the required PremierWave XC HSPA+ unit format. Use Open SSH to perform the conversion.

SSH Client Known Hosts

The SSH Client Known Hosts are used by all applications that play the role of an SSH Client. Specifically in Connect Mode. Configuring these public keys are optional but if they exist another layer of security is offered which helps prevent Man-in-the-Middle (MITM) attacks.

Table 15-2 SSH Client Known Hosts

SSH Settings	Description
Server	Specify either a DNS Hostname or IP Address when adding public host keys for a Server. This Server name should match the name used as the Remote Address in Connect Mode Tunneling.
Public RSA Key	Click Choose File to browse to and select the existing public RSA key you want to use with this user. In Web Manager, you can also browse to the public RSA key to be uploaded. If authentication is successful with the key, no password is required.
Public DSA Key	Click Choose File to browse to and select the existing public DSA key you want to use with this user. In Web Manager, you can also browse to the public DSA key to be uploaded. If authentication is successful with the key, no password is required.
Submit (key)	Click the Submit button after setting the information for SSH Client: Known Hosts .

Note: These settings are not required for communication. They protect against Man-In-The-Middle (MITM) attacks.

SSH Server Authorized Users

The SSH Server Authorized Users are used by all applications that play the role of an SSH Server and specifically Tunneling in Accept Mode. Every user account must have a Password.

The user's Public Keys are optional and only necessary if public key authentication is wanted. Using public key authentication will allow a connection to be made without the password being asked at that time.

Note: When uploading the security keys, ensure the keys are not compromised in transit.

Table 15-3 SSH Server Authorized Users

SSH Settings	Description
Username	Enter a new username or edit an existing one.
Password	Enter a new password or edit an existing one.
Public RSA Key	Click Choose File to browse to and select the existing public RSA key you want to use with this user. In Web Manager, you can also browse to the public RSA key to be uploaded. If authentication is successful with the key, no password is required.
Public DSA Key	Click Choose File to browse to and select the existing public DSA key you want to use with this user. In Web Manager, you can also browse to the public DSA key to be uploaded. If authentication is successful with the key, no password is required.
Add/Edit (key)	Click the Add/Edit button after setting the information for SSH Client: Authorized Users .

SSH Client Users

The SSH Client Users are used by all applications that play the role of an SSH Client. Specifically Tunneling in Connect Mode. To configure the PremierWave XC HSPA+ intelligent gateway as an SSH client, an SSH client user must be both configured and also exist on the remote SSH server.

At the very least, a Password or Key Pair must be configured for a user. The keys for public key authentication can be created elsewhere and uploaded to the device or automatically generated on the device.

If uploading existing Keys, take care to ensure the Private Key will not be compromised in transit. This implies the data is uploaded over some kind of secure private network.

The default Remote Command is '<Default login shell>' which tells the SSH Server to execute a remote shell upon connection. This can be changed to anything the SSH Server on the remote host can execute.

Note: If you are providing a key by uploading a file, make sure that the key is not password protected.

Table 15-4 SSH Client Users

SSH Settings	Description
Username	Enter the name that the device uses to connect to an SSH server.
Password	Enter the password associated with the username.
Remote Command	Enter the command that can be executed remotely. Default is shell, which tells the SSH server to execute a remote shell upon connection. This command can be changed to anything the remote host can perform.
Private Key	Click Choose File to browse to and select the existing private key you want to upload. In Web Manager, you can also browse to the private key to be uploaded. Be sure the private key will not be compromised in transit. This implies the data is uploaded over some kind of secure private network.
Public Key	Click Choose File to browse to and select the existing public key you want to upload. In Web Manager, you can also browse to the public key to be uploaded.
Key Type	Select a bit length for the key: <ul style="list-style-type: none"> ◆ RSA ◆ DSA

SSH Settings (continued)	Description
Add/Edit (button)	Click the Add/Edit button after completing the Username, Password, and Remote Command fields above, and selecting the key and key type.

Table 15-5 Create New Keys

SSH Settings	Description
Username	Enter the name that the device uses to connect to an SSH server.
Key Type	Select a bit length for the key: <ul style="list-style-type: none"> ◆ RSA ◆ DSA
Bit Size	Select the bit length of the new key: <ul style="list-style-type: none"> ◆ 512 ◆ 768 ◆ 1024 <p>Using a larger Bit Size takes more time to generate the key. Approximate times are:</p> <ul style="list-style-type: none"> ◆ 1 second for a 512 bit RSA key ◆ 1 second for a 768 bit RSA key ◆ 1 second for a 1024 bit RSA key ◆ 2 seconds for a 512 bit DSA key ◆ 2 seconds for a 768 bit DSA key ◆ 20 seconds for a 1024 bit DSA key <p>Note: Some SSH clients require RSA host keys to be at least 1024 bits long. This device generates keys up to 2048 bits long.</p>
Submit (key)	Click the Submit button after entering the information for the new key.

To Configure SSH Settings

Using Web Manager

- ◆ To configure SSH, click **SSH** in the menu.

Using the CLI

- ◆ To enter the SSH command level: `enable -> ssh`

Using XML

- ◆ Include in your file: `<configgroup name="ssh">` and `<configgroup name="state">`

SSL Settings

Secure Sockets Layer (SSL) is a protocol for managing the security of data transmission over the Internet. It provides encryption, authentication, and message integrity services. SSL is widely used for secure communication to a web server.

Certificate/Private key combinations can be obtained from an external Certificate Authority (CA) and uploaded into the unit. Self-signed certificates with associated private key can be generated by the device server itself.

Note: The blue text in the XML command strings of this chapter are to be replaced with a user-specified name.

Create a New Credential

After creating a new credential, you can either establish your credential through [Certificate and Key Generation](#) or [Upload Certificate](#).

Table 15-6 Create a New Credentials

Upload Field	Description
Create new credential	Enter the name of the new credential to be created.
Submit (key)	Click the Submit button after entering the new credential name.

To Create a New Credential

Using Web Manager

- ◆ To create a new credential, click **SSL** in the menu and select **Credentials**.

Using the CLI

- ◆ To enter the SSL command level: `enable -> ssl`
- ◆ To enter the Credentials command level: `enable -> ssl -> credentials`

Using XML

- ◆ Not applicable.

Upload Certificate

SSL certificates identify the PremierWave XC HSPA+ intelligent gateway to peers. Certificate and key pairs can be uploaded to the PremierWave XC HSPA+ unit through either the CLI or XML import mechanisms. Certificates can be identified on the PremierWave XC HSPA+ intelligent gateway by a name provided at upload time.

Table 15-7 Upload Certificate Settings

Upload Certificate Settings	Description
New Certificate	Click Choose File to browse to and select the new certificate file to be uploaded. The SSL certificate to be uploaded. RSA or DSA certificates are allowed. The format of the certificate must be PEM. It must start with “-----BEGIN CERTIFICATE-----” and end with “-----END CERTIFICATE-----”. Some Certificate Authorities add comments before and/or after these lines. Those need to be deleted before upload.
New Certificate Type	Choose the new certificate type to be uploaded: <ul style="list-style-type: none"> ◆ PEM ◆ PKCS7 ◆ PKCS12
New Private Key	Click Choose File to browse to and select the certificate type being uploaded. The key needs to belong to the certificate entered above. The format of the file must be PEM. It must start with “-----BEGIN RSA PRIVATE KEY-----” and end with “-----END RSA PRIVATE KEY-----”. Read DSA instead of RSA in case of a DSA key. Some Certificate Authorities add comments before and/or after these lines. Those need to be deleted before upload.
New Key Type	Click Choose File to browse to and select the key type being uploaded: <ul style="list-style-type: none"> ◆ PEM ◆ Encrypted PEM ◆ PKCS12

Certificate and Key Generation

The PremierWave XC HSPA+ intelligent gateway can generate self signed certificates and their corresponding keys. This can be done for both the rsa and dsa certificate formats. Certificates can be identified on the PremierWave XC HSPA+ unit by a name provided at generation time.

Table 15-8 Certificate and Key Generation Settings

Certificate Generation Settings	Description
Country (2 Letter Code)	Enter the 2-letter country code to be assigned to the new self-signed certificate. Examples: US for United States and CA for Canada
State/Province	Enter the state or province to be assigned to the new self-signed certificate.
Locality (City)	Enter the city or locality to be assigned to the new self-signed certificate.
Organization	Enter the organization to be associated with the new self-signed certificate.

Certificate Generation Settings (continued)	Description
Organization Unit	Enter the organizational unit to be associated with the new self-signed certificate.
Common Name	Enter the common name to be associated with the new self signed certificate, preferably matching the host name or the ip address of the device, whichever will be the intended access approach. This is a required field.
Expires	Enter the expiration date, in mm/dd/yyyy format, for the new self-signed certificate. Example: An expiration date of May 9, 2018 is entered as 05/09/2018.
Type	Select the type of key: <ul style="list-style-type: none"> ◆ RSA = Public-Key Cryptography algorithm based on large prime numbers, invented by Rivest Shamir and Adleman. Used for encryption and signing. ◆ DSA = Digital Signature Algorithm also based on large prime numbers, but can only be used for signing. Developed by the US government to avoid the patents on RSA.
Key Length	Select the bit size of the new self-signed certificate. Choices are: <ul style="list-style-type: none"> ◆ 512 bit ◆ 768 bit ◆ 1024 bit ◆ 2048 bit ◆ 4096 bit The larger the bit size, the longer it takes to generate the key.
Submit (key)	Click the Submit button after setting the information for new self-signed certificate.

To Configure an Existing SSL Credential

Follow these steps after a new credential has been established via [Create a New Credential on page 105](#).

Using Web Manager

- ◆ To configure an existing SSL Credential, click **SSL** in the menu, select **Credentials**, and click on the name of an existing SSL credential.

Using the CLI

- ◆ To enter the SSL command level: `enable -> ssl`
- ◆ To enter the Credential command level: `enable -> ssl -> credentials`

Using XML

- ◆ Include in your file:

```
<configgroup name="ssl">
and <configitem name="credentials" instance="name">
and <value name="RSA certificate"/> or <value name="DSA certificate"/>
```

Trusted Authorities

One or more authority certificates are needed to verify a peer's identity. These certificates do not require a private key.

Table 15-9 Trusted Authority Settings

Trusted Authorities Settings	Description
Authority	Click Choose File to browse to and select the SSL authority certificate. RSA or DSA certificates are allowed. The format of the authority certificate can be PEM or PKCS7. PEM files must start with "-----BEGIN CERTIFICATE-----" and end with "-----END CERTIFICATE-----". Some Certificate Authorities add comments before and/or after these lines. Those need to be deleted before upload.
Authority Certificate Type	This field will be automatically updated depending upon extension of the certificate entered. If the field is NONE i.e., certificate is not supported then it will not load. If the field is PKCS12, In the Password: field corresponding PKCS12 password should be entered.
Delete	Click the Delete button beside a specific certificate authority to delete it.
Delete All	Click the Delete All button to delete all existing certificate authorities.

Using Web Manager

- ◆ To upload an Authority Certificate, click **SSL** in the menu and select **Trusted Authorities**.

Using the CLI

- ◆ To enter the SSL command level: `enable -> ssl`
- ◆ To enter the Trusted Authorities command level: `enable -> ssl -> trusted authorities`

Using XML

- ◆ Include in your file:

```
<configgroup name="ssl">
and <configitem name="trusted authority" instance="1">
and <configitem name="intermediate authority" instance="1">
```

16: Maintenance and Diagnostics Settings

Filesystem Settings

Use the file system to list, view, create, upload, copy, move, remove, and transfer files. The PremierWave XC HSPA+ intelligent gateway uses a flash file system to store files.

Statistics

The filesystem statistics page displays statistics and current usage information of the flash filesystem. The filesystem can be formatted here.

Warning: *Formatting the filesystem will delete all files on it.*

When the USB drive is connected to one of the two USB ports on the device, it will be automatically mounted and accessed using the filesystem. USB drives can be simultaneously connected to both the USB ports. If the USB mount option is disabled, USB drive will not be mounted.

Table 16-1 File Statistics

Filesystem Commands	Description
Format	Displays a list of files on the PremierWave XC HSPA+ device, and their respective sizes.
USB Auto Mount	Click to enable or disable USB auto mount.

To View Statistics

Using Web Manager

- ◆ To view statistics, format the filesystem or configure USB auto mount features, click **Filesystem** in the menu and select **Statistics**.

File Display

View the list of existing files and their contents in the ASCII or hexadecimal formats.

Table 16-2 File Display Settings

File Display Commands	Description
ls	Displays a list of files on the PremierWave XC HSPA+ device, and their respective sizes.
cat	Displays the specified file in ASCII format.
dump	Displays the specified file in a combination of hexadecimal and ASCII formats.
pwd	Print working directory.
cd	Change directories.
show tree	Display file/directory tree.

To Display Files

Using Web Manager

- ◆ To view existing files and file contents, click **Filesystem** in the menu and select **Browse**.

Using the CLI

- ◆ To enter the Filesystem command level: `enable -> filesystem`

Using XML

- ◆ Not applicable.

File Modification

The PremierWave XC HSPA+ intelligent gateway allows for the creation and removal of files on the Filesystem.

Table 16-3 File Modification Settings

File Modification Commands	Description
rm	Removes the specified file from the file system.
touch	Creates the specified file as an empty file.
cp	Creates a copy of a file.
mkdir	Creates a directory on the file system.
rmdir	Removes a directory from the file system.
format	Format the file system and remove all data.

File Transfer

Files can be transferred to and from the PremierWave XC HSPA+ device via the TFTP protocol. This can be useful for saving and restoring XML configuration files. Files can also be uploaded via HTTP.

Table 16-4 File Transfer Settings

File Transfer Settings	Description
Create	Type in a File or Directory name and click the Create button. The newly created File or Directory will appear above.
Upload File	Click Choose File to browse to location of the file to be uploaded via HTTP. Click Upload to upload the chosen file.
Copy File	Enter the Source and Destination name for file to be copied and click the Copy button.
Move	Enter the Source and Destination name for file to be moved and click the Move button.

File Transfer Settings	Description
TFTP	
Action	Select the action that is to be performed via TFTP: <ul style="list-style-type: none"> ◆ Get = a “get” command will be executed to store a file locally. ◆ Put = a “put” command will be executed to send a file to a remote location.
Local File	Enter the name of the local file on which the specified “get” or “put” action is to be performed.
Remote File	Enter the name of the file at the remote location that is to be stored locally (“get”) or externally (“put”).
Host	Enter the IP address or name of the host involved in this operation.
Port	Enter the number of the port involved in TFTP operations.
Transfer (button)	Click the Transfer button after TFTP settings are entered.

To Transfer or Modify Filesystem Files

Using Web Manager

- ◆ To create a new file or directory, upload an existing file, copy or move a file, or view existing files, click **Filesystem** in the menu and select **Browse**.

Using the CLI

- ◆ To enter the Filesystem command level: `enable -> filesystem`

Using XML

- ◆ Not applicable.

Protocol Stack Settings

There are various low level network stack specific items that are available for configuration. This includes settings related to IP, ICMP, ARP and SMTP, which are described in the sections below.

IP Settings

Table 16-5 IP Protocol Stack Settings

Protocol Stack IP Settings	Description
IP Time to Live	This value typically fills the Time To Live in the IP header. SNMP refers to this value as "ipDefaultTTL" Enter the number of hops to be transmitted before the packet is discarded.

Protocol Stack IP Settings (continued)	Description
Multicast Time to Live	This value fills the Time To Live in any multicast IP header. Normally this value will be one so the packet will be blocked at the first router. It is the number of hops allowed before a Multicast packet is discarded. Enter the value to be greater than one to intentionally propagate multicast packets to additional routers.

To Configure IP Protocol Stack Settings

Using Web Manager

- ◆ To configure IP protocol settings, click **Protocol Stack** in the menu and select **IP**.

Using the CLI

- ◆ To enter the command level: `enable -> config -> ip`

Using XML

- ◆ Include in your file: `<configgroup name="ip">`

ICMP Settings

Table 16-6 ICMP Protocol Stack Settings

Protocol Stack ICMP Settings	Description
State	Click to enable or disable the processing of ICMP messages. This includes both incoming and outgoing messages.

To Configure ICMP Protocol Stack Settings

Using Web Manager

- ◆ To configure ICMP protocol settings, click **Protocol Stack** in the menu and select **ICMP**.

Using the CLI

- ◆ To enter the command level: `enable -> config -> icmp`

Using XML

- ◆ Include in your file: `<configgroup name="icmp">`

To View ICMP Protocol Stack Settings

Using Web Manager

- ◆ To view ICMPv6 protocol settings, click **Protocol Stack** in the menu and select **ICMPv6**.

Using the CLI

- ◆ Not applicable.

Using XML

- ◆ Not applicable.

ARP Settings**Table 16-7 ARP Protocol Stack Settings**

Protocol Stack ARP Settings	Description
IP Address	Enter the IP address to add to the ARP cache. After entering the MAC address, click the Add button.
MAC Address	Enter the MAC address to add to the ARP cache. After also entering the IP address, click the Add button.
Add (button)	Click the Add button after entering the ARP Cache information.
Remove	Click the Remove link beside a specific address to remove it.
Remove All	Click the Remove All link underneath all listed addresses to remove all the addresses.

To Configure ARP Network Stack Settings**Using Web Manager**

- ◆ To configure ARP protocol settings, click **Protocol Stack** in the menu and select **ARP**.

Using the CLI

- ◆ To enter the command level: `enable -> config -> arp`

Using XML

- ◆ Include in your file: `<configgroup name="arp">`

Diagnostics

The PremierWave XC HSPA+ intelligent gateway has several tools for diagnostics and statistics. Various options allow for the configuration or viewing of IP socket information, ping, traceroute, memory, and processes.

Hardware

To View Hardware Information

Using Web Manager

- ◆ To view hardware information, click **Diagnostics** in the menu and select **Hardware**.

Using the CLI

- ◆ To enter the command level: `enable -> device, show hardware information`

Using XML

- ◆ Include in your file: `<statusgroup name="hardware">`

IP Sockets

You can view the list of listening and connected IP sockets.

To View the List of IP Sockets

Using Web Manager

- ◆ To view IP Sockets, click **Diagnostics** in the menu and select **IP Sockets**.

Using the CLI

- ◆ To enter the command level: `enable, show ip sockets`

Using XML

- ◆ Include in your file: `<statusgroup name="ip sockets">`

Ping

The ping command can be used to test connectivity to a remote host.

Table 16-8 Ping Settings

Diagnostics: Ping Settings	Description
Host	Enter the IP address or host name for the PremierWave unit to ping.
Count	Enter the number of ping packets PremierWave device should attempt to send to the Host . The default is 5 .

Diagnostics: Ping Settings (continued)	Description
Timeout	Enter the time, in seconds, for the PremierWave XC intelligent gateway to wait for a response from the host before timing out. The default is 5 seconds.
Submit (Button)	Click the Submit button after entering ping information.

To Ping a Remote Host

Using Web Manager

- ◆ To ping a Remote Host, click **Diagnostics** in the menu and select **Ping**.

Using the CLI

- ◆ To enter the command level: `enable, ping <host> <count> <timeout>`

Using XML

- ◆ Not applicable.

Traceroute

Here you can trace a packet from the PremierWave XC HSPA+ intelligent gateway to an Internet host, showing how many hops the packet requires to reach the host and how long each hop takes. If you visit a web site whose pages appear slowly, you can use traceroute to determine where the longest delays are occurring.

Table 16-9 Traceroute Settings

Diagnostics: Traceroute Settings	Description
Host	Enter the IP address or DNS hostname. This address is used to show the path between it and the PremierWave device when issuing the traceroute command.
Protocol	Select the traceroute protocol from the drop-down menu.
Submit (button)	Click the Submit button after entering traceroute information.

To Perform a Traceroute

Using Web Manager

- ◆ To perform a Traceroute, click **Diagnostics** in the menu and select **Traceroute**.

Using the CLI

- ◆ To enter the command level: `enable, trace route <host>`

Using XML

- ◆ Not applicable.

Log

Table 16-10 Log Settings

Diagnostics: Log	Description
Log Output	Select a diagnostic log output type: <ul style="list-style-type: none"> ◆ Disable - Turn off the logging feature. ◆ Filesystem - Directs logging to /log.txt. ◆ Line (1 or 2) - Directs logging to the selected serial line.
Log Max Length	Set the maximum length of the log.txt file in Kbytes. <i>Note: This setting becomes available when Filesystem is selected.</i>
Log Verbosity Level	Select the Verbosity Level from the drop-down menu to specify the verbosity of system messages logged to the Syslog Host.
Log Cellular Modem IO	Select to enable or disable the logging of commands and responses with the cellular modem.
Save Cellular Network Traffic	Select to enable or disable the saving of cellular network traffic to the filesystem. IF this option is enabled, the output goes to PPP-YYY-MM-DD_HH.MM.pcap. PPP-YYY-MM-DD_HH.MM is the time at which capture was started.

To Configure the Diagnostic Log Output

Using Web Manager

- ◆ To configure the Diagnostic Log output, click **Diagnostics** in the menu and select **Log**.

Using the CLI

- ◆ To enter the command level: enable -> config -> diagnostics -> log

Using XML

- ◆ Include in your file:

```
<configgroup name="diagnostics">
```

and

```
<configitem name="log">
```

Memory

The memory information shows the total, used, and available memory (in kilobytes).

To View Memory Usage

Using Web Manager

- ◆ To view memory information, click **Diagnostics** in the menu and select **Memory**.

Using the CLI

- ◆ To enter the command level: enable -> device, show memory

Using XML

- ◆ Include in your file: `<statusgroup name="memory" >`

Processes

The PremierWave XC HSPA+ device shows all the processes currently running on the system. It shows the Process ID (PID), Parent Process ID (PPID), user, CPU percentage, percentage of total CPU cycles, and process command line information.

To View Process Information

Using Web Manager

- ◆ To view process information, click **Diagnostics** in the menu and select **Processes**.

Using the CLI

- ◆ To enter the command level: `enable, show processes`

Using XML

- ◆ Include in your file: `<statusgroup name="processes" >`

Threads

The PremierWave unit threads information shows details of threads in the `ltrx_evo` task which can be useful for technical experts in debugging.

To View Thread Information

Using Web Manager

- ◆ To view thread information, click **Diagnostics** in the menu and select **Threads**.

Using the CLI

- ◆ To enter the command level: `enable -> device, show task state`

Clock

The Clock settings page can be updated by one of three methods: manually entering the date and time, synchronizing with the SNTP, or synchronizing with the cellular network server. If the network synchronization method is selected, the user can also choose the time zone to be detected automatically.

Table 16-11 Clock Settings

Clock	Description
Method	Select a clock change method from the drop-down menu: <ul style="list-style-type: none"> ◆ Manual: this option allows you to directly set the date and time. ◆ SNTP: this option keeps the time synchronized with the NTP Server. ◆ Cellular Network: this option allows the time to be synchronized with the cellular network.
Date	Use the drop-down menu to select the Year, Month and Day . This option becomes available when the Manual method is selected.
Time (24 hour)	Use the drop-down menu to select the Hour, Min and Sec . This option becomes available when the Manual method is selected.
NTP Server	Set NTP Server to an NTP server's IP address or hostname. This option becomes available when the SNTP method is selected.
Time Zone	Select the geographical time zone from the drop-down list.

To Specify Clock Setting Method

Using Web Manager

- ◆ To view thread information, click **Clock** in the menu.

Using the CLI

- ◆ To enter the command level: `enable -> config -> clock`

Using the XML

Include in your file: `<configgroup name="clock">`

System Settings

The PremierWave XC HSPA+ intelligent gateway system settings allow for rebooting the device, restoring factory defaults, uploading new firmware and updating a system's short and long name.

Note: Anytime you reboot the unit, this operation will take some time to complete. Please wait a minimum of 10-20 seconds after rebooting the unit before attempting to make any subsequent connections.

Table 16-12 System Settings

System Settings	Description
State	Click to enable or disable the reboot schedule.
Current date and time	Displays the current date and time.
Schedule	Select the Daily or Interval schedule from the drop-down menu.
Time (24 hour)	Enter the Hour and Min (minute) in 24 hour time, for the reboot time if Daily schedule is selected.
Interval	Enter the interval number and select the interval type (Hours , Days , or Weeks) from the drop-down menu.
Reboot Device	Click the Reboot button to reboot the device.
Restore Factory Defaults	Click Factory Defaults to restore the device to the original factory settings. All configuration will be lost. The PremierWave XC HSPA+ intelligent gateway unit automatically reboots upon setting back to the defaults.
Upload New Firmware	Write the new firmware file to firmware.rom on the PremierWave unit by clicking Choose File to browse to the new firmware file, and click Upload button to upload the chosen file to the system. The device automatically reboots upon the installation of new firmware. See the section, FTP Settings on page 86 .
Short Name	Enter a short name for the system name. A maximum of 32 characters are allowed.
Long Name	Enter a long name for the system name. A maximum of 64 characters are allowed.
Submit (button)	Click Submit after entering the system name.

To Reboot or Restore Factory Defaults

Using Web Manager

- ◆ To access the area with options to reboot, restore to factory defaults, upload new firmware, update the system name (long or short names) or to view the current configuration, click **System** in the menu.

Using the CLI

- ◆ To enter the command level: `enable`

Using XML

- ◆ Include in your file: `<configgroup name="xml import control">`

17: Management Interface Settings

Command Line Interface Settings

The Command Line Interface settings allow you to control how users connect to and interact with the command line of the PremierWave XC HSPA+ intelligent gateway. It is possible to configure access via the Telnet and SSH protocols, in addition to general CLI options.

Basic CLI Settings

The basic CLI settings control general CLI access and usability options.

Table 17-1 CLI Configuration Settings

Command Line Interface Configuration Settings	Description
Login Password	Enter the password for the admin account. The factory default password is the last 8 characters of the Device ID (for devices manufactured after January 1, 2020) or " PASS " (for all older devices).
Enable Level Password	Enter the password for access to the Command Mode Enable level. There is no password by default.
Quit Connect Line	Enter the Quit Connect Line string to be used to terminate a Telnet and SSH session and resume the CLI. Type <control> before the key to be pressed while holding down the [Ctrl] key (example: <control>L)
Inactivity Timeout	Set a time period in which the CLI session should disconnect if no data is received. Enter 0 to disable. Blank the display field to restore the default.
Line Authentication	Select to enable or disable authentication for CLI access on the .

To View and Configure Basic CLI Settings

Using Web Manager

- ◆ To view CLI statistics, click **CLI** in the menu and select **Statistics**.
- ◆ To configure basic CLI settings, click **CLI** in the menu and select **Configuration**.

Using the CLI

- ◆ To enter CLI command level: `enable -> config -> cli`

Using XML

- ◆ Include in your file: `<configgroup name="cli">`

Telnet Settings

The Telnet settings control CLI access to the PremierWave XC HSPA+ intelligent gateway telnet over the Telnet protocol.

Table 17-2 Telnet Settings

Telnet Settings	Description
Telnet State	Select to enable or disable CLI access via Telnet
Telnet Port	Enter an alternative Telnet Port to override the default used by the CLI server. Blank the field to restore the default.
Telnet Max Sessions	Specify the maximum number of concurrent Telnet sessions that will be allowed.
Telnet Authentication	Select to enable or disable authentication for Telnet logins.

To Configure Telnet CLI Settings

Using Web Manager

- ◆ To configure Telnet settings, click **CLI** in the menu and select **Configuration**.

Using the CLI

- ◆ To enter the Telnet command level: enable -> config -> cli -> Telnet

Using XML

- ◆ Include in your file:

```
<configgroup name="Telnet">
and
<configitem name="state">
and
<configitem name="authentication">
```

SSH CLI Settings

The SSH settings control CLI access to the PremierWave device over the SSH protocol.

Table 17-3 SSH Settings

SSH Settings	Description
SSH State	Select to enable or disable CLI access via SSH.
SSH Port	Specify the SSH Port and override the default, as needed. Blank the field to restore the default.
SSH Max Sessions	Specify the maximum number of concurrent SSH sessions that will be allowed.

To Configure SSH Settings

Using Web Manager

- ◆ To configure SSH settings, click **CLI** in the menu and select **Configuration**.

Using the CLI

- ◆ To enter the SSH command level: `enable -> config -> cli -> ssh`

Using XML

- ◆ Include in your file:

```
<configgroup name="ssh"> and <configitem name="state">
```

XML Settings

The PremierWave XC HSPA+ intelligent gateway allows for the configuration of units using an XML configuration record (XCR). Export a current configuration for use on other PremierWave XC HSPA+ unit or import a saved configuration file.

XML: Export Configuration

You can export the current system configuration in XML format. The generated XML file can be imported later to restore a configuration. It can also be modified and imported to update the configuration on this PremierWave XC HSPA+ unit or another. The XML data can be dumped to the screen or exported to a file on the file system.

By default, all groups are exported. You may also select a subset of groups to export.

Table 17-4 XML Exporting Configuration

XML Export Configuration Settings	Description
Export to browser	Select this option to export the XCR data in the selected fields to the browser. Use the "xcr dump" command to export the data to the browser.
Export to local file	Select this option to export the XCR data to a file on the device. If you select this option, enter a file name for the XML configuration record. Use the "xcr export" command to export the data to a local file.
Export secrets	Select to export secret password and key information. Use only with a secure link, and save only in secure locations. Note: Only use with extreme caution.
Comments	Select this option to include descriptive comments in the XML.
Lines to Export	Select instances to be exported in the line, serial, tunnel and terminal groups. Click Clear All to clear all checkmarks, or Select All to check all checkmarks.
Groups to Export	Check the configuration groups that are to be exported to the XML configuration record. The group list should be comma delimited and encased in double quotes. The list of available groups can be viewed with the "xcr list" command. Click Clear All to clear all checkmarks, or Select All but Networking to check all checkmarks except Networking.
Export (button)	Click Export after selecting the XML: Export Configuration settings.

To Export Configuration in XML Format

Using Web Manager

- ◆ To export configuration format, click **XML** in the menu and select **Export Configuration**.

Using the CLI

- ◆ To enter the XML command level: `enable -> xml`

Using XML

- ◆ Not applicable.

XML: Export Status

You can export the current status in XML format. By default, all groups are exported. You may also select a subset of groups to export.

Table 17-5 Exporting Status

XML Export Status Settings	Description
Export to browser	Select this option to export the XCR data in the selected fields to the browser. Use the "xcr dump" command to export the data to the browser.
Export to local file	Select this option to export the XCR data to a file on the device. If you select this option, enter a file name for the XML configuration record. Use the "xcr export" command to export the data to a local file.
Lines to Export	Select instances to be exported in the line, serial, tunnel and terminal groups. Click Clear All to clear all checkmarks, or Select All to check all checkmarks.
Groups to Export	Check the configuration groups that are to be exported to the XML configuration record. The group list should be comma delimited and encased in double quotes. The list of available groups can be viewed with the "xcr list" command. Click Clear Click Clear All to clear all checkmarks, or Select All to check all checkmarks.
Export (button)	Click Export after selecting the XML: Export Status settings.

To Export in XML Format

Using Web Manager

- ◆ To export configuration format, click **XML** in the menu and select **Export Status**.

Using the CLI

- ◆ To enter the XML command level: `enable -> xml`

Using XML

- ◆ Not applicable.

XML: Import Configuration

Here you can import a system configuration from an XML file.

The XML data can be imported from a file on the file system or pasted into a CLI session. The groups to import can be specified at the command line, the default is all groups.

Configuration from External File

This import option requires entering the path and file name of the external XCR file you want to import.

Configuration from Filesystem

This import option picks up settings from a file and your import selections of groups, lines, and instances. The list of files can be viewed from the filesystem level of the CLI.

Line(s) from single line Settings on the Filesystem

This import option copies line settings from an the input file containing only one Line instance to all of the selected Lines.

Table 17-6 Import Configuration from Filesystem Settings

Import Configuration from Filesystem Settings	Description
Filename	Enter the name of the file on the PremierWave unit (local to its filesystem) that contains XCR data.
Lines to Import	Select filter instances to be imported in the line, serial, tunnel and terminal groups. This affects both Whole Groups to Import and Text List selections. Click Clear All to clear all checkmarks, or Select All to check all checkmarks.
Whole Groups to Import	Select the configuration groups to import from the XML configuration record. This option imports all instances of each selected group. Click Clear All to clear all checkmarks, or Select All but Networking to check all checkmarks except Networking.
Export (button)	Click Export after selecting the XML: Import Configuration settings.

To Import Configuration in XML Format

Using Web Manager

- ◆ To import configuration, click **XML** in the menu and select **Import Configuration**.

Using the CLI

- ◆ To enter the XML command level: `enable -> xml`

Using XML

- ◆ Not applicable.

18: Branding the PremierWave XC HSPA+ Device

This chapter describes how to brand your PremierWave XC HSPA+ intelligent gateway by using Web Manager and Command Line Interface (CLI). It contains the following sections on customization:

- ◆ [Web Manager Customization](#)
- ◆ [Short and Long Name Customization](#)

Web Manager Customization

Customize the Web Manager's appearance by modifying `index.html`, `style.css`, and the product logo. The style (fonts, colors, and spacing) of the Web Manager is controlled with `style.css`. The text and graphics are controlled with `index.html`. The product logo is the image in top-left corner of the page and defaults to a product name image.

Note: *The recommended dimensions of the new graphic are 300px width and 50px height.*

The Web Manager files are hidden and are incorporated directly into the firmware image but may be overridden by placing the appropriate file in the appropriate directory on the PremierWave XC HSPA+ unit file system.

Web Manager files can be retrieved and overridden with the following procedure:

1. FTP to the PremierWave XC HSPA+ device.
2. Make a directory (`mkdir`) and name it `http/config`.
3. Change to the directory (`cd`) that you created in step 2 (`http/config`).
4. Save the contents of `index.html` and `style.css` by using a web browser and navigating to `http://<PremierWave hostname>/config/index.html` and `http://<PremierWave hostname>/config/style.css`.
5. Modify the file as required or create a new one with the same name.
6. To customize the product logo, save the image of your choice as `PremierWave_logo.gif` and `PremierWave.png`.
7. Put the file(s) by using `put <filename>`.
8. Type `quit`. The overriding files appear in the file system's `http/config` directory.
9. Restart any open browser to view the changes.
10. If you wish to go back to the default files in the firmware image, simply delete the overriding files from the file system.

Short and Long Name Customization

You can customize the short and long names in your PremierWave XC HSPA+ intelligent gateway. The names display in the CLI show command and in the System web page in the Current Configuration table. The short name is used for the show command. Both names display in the CLI Product Type field.

Note: See [System Settings \(on page 119\)](#) for additional configuration options available on the Systems page.

Table 18-1 Short and Long Name Settings

Name Settings	Description
Short Name	Enter a short name for the system name. A maximum of 32 characters are allowed.
Long Name	Enter a long name for the system name. A maximum of 64 characters are allowed.

To Customize Short or Long Names

Using Web Manager

- ◆ To access the area with options to customize the short name and the long name of the product, or to view the current configuration, click **System** in the menu.

Using the CLI

- ◆ To enter the command level: `enable`

Using XML

- ◆ Include in your file:

```
<configitem name="short name">
and
<configitem name="long name">
```

Appendix A: Technical Specifications

Network

Cellular

- ◆ UMTS/HSPA+ (850/800/900/1900/2100 MHz)
- ◆ GSM/GPRS/EDGE (850/900/1800/1900 MHz)
- ◆ Transfer Rates - up to 14.4 Mbps (downlink), up to 7.2Mbps (uplink)
- ◆ SMS Inbound - Shoulder Tap, Relay Control, Tunneling*
- ◆ SMS Outbound - Event Notification, Tunneling*
- ◆ 1 Secure SIM Slot
- ◆ 2 x Omni-Directional Penta-band Antennas

Ethernet

- ◆ 10BaseT and 100Base-TX Link (auto sensing – MDIX, full and half duplex support)
- ◆ RJ-45 Connector with LEDs (operation and link)
- ◆ 1.5 KV Isolation

Serial Interface

- ◆ Software selectable RS-232/422/485
- ◆ Software selectable RS-485 termination
- ◆ Serial data rates from 300 to 921 Kbps
- ◆ Characters: 7 or 8 data bits
- ◆ Parity: Odd, Even, None
- ◆ Stop Bits: 1 or 2
- ◆ Modem Control: DTR, DSR/DCD
- ◆ Flow Control: XON/XOFF (SW), CTS/RTS (HW)

Serial Connector

- ◆ 2 x DB9M (DTE) with 15KV ESD protection per port

USB Interface

- ◆ USB Mass Storage Device Support

USB Connector

- ◆ 1 x USB Type A Host Connector (USB 2.0)

I/O Interface

Input

- ◆ Connection: Sensors/Events
- ◆ Voltage acceptance: 0 to 30 VDC
- ◆ Digital input event: User configurable
- ◆ Optical: 1.5 KV

Output

- ◆ Software: Turn Relay Output ON and OFF
- ◆ Automatic Event Trigger: ON or OFF (possible events include loss of cellular link, loss of Ethernet link, digital input event)
- ◆ Relay Output Response: User configurable
- ◆ Support 1A @24V

I/O Connectors

- ◆ 2 x Digital Input, 1 x Relay Output (Terminal Block)

LED Indicators

- ◆ Cellular Mode, Signal Strength, Serial RX/TX, USB Connection, System Status, Power, Ethernet Speed, Ethernet Activity

Routing/Gateway

- ◆ NAT, Port Forwarding, SPI Firewall
- ◆ WAN Failover/Failback
- ◆ Multiple Ethernet LAN Hosts
- ◆ Multihoming

Protocol Support

- ◆ Network Services: SMTP Client, RSS, Telnet Server/Client, SNTP, FTP Server/Client, SFTP Server/Client, TFTP Server, Syslog
- ◆ Network Management: SNMP v1/v2c/v3*
- ◆ Network Security: HTTPS Server/Client, SSH Server/Client, SSL Server/Client, TLS, IPSec*
- ◆ Network Protocols: ARP, HTTP, UDP/IP, TCP/IP, ICMP, BOOTP, DHCP, Auto IP, DNS
- ◆ Discovery Protocols: UPnP
- ◆ Industrial Protocols*: Modbus TCP, Modbus RTU, Modbus ASCII

Event Triggers and Actions

- ◆ Events: Cellular Link State Change, Ethernet Link State Change, Digital Input State Change
- ◆ Actions: SMS, Email, HTTP Post, FTP Put, Relay Output, SNMP, Trap

Security

- ◆ SSL v3, SSH v2, Client & Server, Supports up to 2048-bit certificates
- ◆ Encryption: AES, 3DES, RC4
- ◆ Authentication: SHA-1, MDS, Base-64 User Access Lists

Management

- ◆ Web Browser (SSL option for secure login)
- ◆ CLI (over Serial Ports, Telnet or SSH)
- ◆ XML Configuration Records via CLI or FTP
- ◆ Supports SNMP

Software

- ◆ Lantronix Device Server Application Suite
- ◆ DeviceInstaller

Power

- ◆ Input Voltage: 9-30 VDC
- ◆ Power Consumption: 3.6 Watts (typical)
- ◆ Power Supply (100 - 240 VAC, 50-60 Hz, 12 VDC @ 1.8A) with locking barrel connector and regional adapters, -40° to +75°C

Environmental

- ◆ Operating Temperature: -40° to +70°C
- ◆ Storage Temperature : -40° to +85°C
- ◆ Relative Humidity: 5% to 95% non-condensing
- ◆ IP Rating: 30

Dimensions

- ◆ Size: (L x W x H): 109 mm x 109 mm x 30 mm (4.3 in x 4.3 in x 1.2 in)
- ◆ Weight: 0.24 kg (0.55 lb)

Appendix B: Compliance

(According to ISO/IEC Guide 17050-1, 17050-2 and EN 45014)

Manufacturer's Name & Address:

Lantronix, Inc.
7535 Irvine Center Drive, Suite 100, Irvine, CA 92618 USA

Product Name Model:

PremierWave XC HSPA+ ® Intelligent Gateway This device complies with part 15 of the FCC Rules. Operation is subject to the following two conditions: (1) This device may not cause harmful interference, and (2) this device must accept any interference received, including interference that may cause undesired operation.

This device complies with Industry Canada license-exempt RSS standard(s). Operation is subject to the following two conditions: (1) this device may not cause interference, and (2) this device must accept any interference, including interference that may cause undesired operation of the device.

Note: *Under Industry Canada regulations, this radio transmitter may only operate using an antenna of a type and maximum (or lesser) gain approved for the transmitter by Industry Canada. To reduce potential radio interference to other users, the antenna type and its gain should be so chosen that the equivalent isotropically radiated power (e.i.r.p.) is not more than that necessary for successful communication.*

This radio transmitter (PremierWave XC HSPA+, 3867A-PWXCHSPA) has been approved by Industry Canada to operate with the antenna types listed below with the maximum permissible gain and required antenna impedance for each antenna type indicated. Antenna types not included in this list, having a gain greater than the maximum gain indicated for that type, are strictly prohibited for use with this device.

Approved Antenna. Taoglas, TG.09.113, Hinged Monopole, 2.8dBi peak gain. Cet appareil conforme aux normes exempts de licence CNR d'Industrie Canada. Son fonctionnement est soumis aux deux conditions suivantes: (1) cet appareil ne doit pas provoquer d'interférences, et (2) cet appareil doit accepter toute interférence, y compris les interférences pouvant provoquer un fonctionnement indésirable de l'appareil.

Note: *En vertu de la réglementation d' Industrie Canada, cet émetteur de radio ne peut fonctionner à l'aide d'une antenne d'un type et un maximum (ou moins) gain approuvé pour l'émetteur par Industrie Canada. Pour réduire risque d'interférence aux autres utilisateurs, le type d'antenne et son gain doivent être choisis afin que la puissance isotrope rayonnée équivalente (PIRE) ne dépasse pas ce qui est nécessaire pour une communication réussie.*

Cet émetteur radio (PremierWave XC HSPA+, 3867A-PWXCHSPA) a été approuvé par Industrie Canada pour fonctionner avec les types d'antennes énumérés ci-dessous avec le gain maximal admissible et impédance d'antenne requise pour chaque type d'antenne indiqué. Types d'antennes pas inclus dans cette liste, ayant un gain supérieur au gain maximal indiqué pour ce type, sont strictement interdits pour une utilisation avec cet appareil.

Approuvé antenne. Taoglas, TG.09.113, Monopole charnière, un gain maximal 2.8dBi

Conforms to the following standards or other normative documents:

Safety

- ◆ Low Voltage Directive (2006/95/EC)
- ◆ IEC 60950-1:2005/A1:2010
- ◆ EN 60950-1:+A11+A1+A12:2011
- ◆ UL 60950-1, 1st Edition, 2007-10-31
- ◆ CSA C22.2 No. 60950-1-03, 1st Edition, 2006-07
- ◆ EN 62311 (2008)

Emissions and Immunity

US

- ◆ FCC 22H (2013)
- ◆ FCC 24E (2013)
- ◆ FCC 15.109 (2013) Class B
- ◆ FCC 15.107 (2013) Class B

Canada

- ◆ RSS-132 (2013)
- ◆ RSS-133 (2013)
- ◆ RSS-210 (2010)

Europe

- ◆ R&TTE Directive 1999/5/EC
- ◆ EN 301 908-1 V5.2.1 (2011)
- ◆ EN 301 908-2 V5.2.1 (2011)
- ◆ EN 301 511 V9.0.2 (2003)
- ◆ EN 301 489-1 V1.9.2 (2011)
- ◆ EN 301 489-7 V1.3.1 (2005)
- ◆ EN 301 489-24 V1.5.1 (2010)
- ◆ EN 55022 (2010) Class B
- ◆ EN 55024

Transmitter Certification IDs

- ◆ FCC: R68PWXCHSPA
- ◆ IC: 3867A-PWXCHSPA

Carrier Certifications

- ◆ PTCRB
- ◆ AT&T

Manufacturer's Contact:

Lantronix, Inc.
7535 Irvine Center Drive, Suite 100
Irvine, CA 92618 USA
Tel: 949-453-3990
Fax: 949-453-3995

RoHS, REACH and WEEE Compliance Statement

Please visit <http://www.lantronix.com/legal/rohs/> for Lantronix's statement about RoHS, REACH and WEEE compliance.

Appendix C: Lantronix Technical Support

Lantronix offers many resources to support our customers and products at <http://www.lantronix.com/support>. For instance, you can ask a question, find firmware downloads, access the FTP site and search through tutorials. At this site you can also find FAQs, bulletins, warranty information, extended support services and product documentation.

To contact technical support or sales, look up your local office at <http://www.lantronix.com/about/contact.html>. When you report a problem, please provide the following information:

- ◆ Your name, company name, address, and phone number
- ◆ Lantronix product and model number
- ◆ Lantronix MAC address or serial number
- ◆ Firmware version and current configuration
- ◆ Description of the problem
- ◆ Status of the unit when the problem occurred (please try to include information on user and network activity at the time of the problem).

Appendix D: Binary to Hexadecimal Conversions

Many of the unit's configuration procedures require you to assemble a series of options (represented as bits) into a complete command (represented as a byte).

The resulting binary value must be converted to a hexadecimal representation.

Use this chapter to learn to convert binary values to hexadecimal or to look up hexadecimal values in the tables of configuration options. The tables include:

- ◆ Command Mode (serial string sign-on message)
- ◆ AES Keys

Converting Binary to Hexadecimal

Following are two simple ways to convert binary numbers to hexadecimal notation.

Conversion Table

Hexadecimal digits have values ranging from 0 to F, which are represented as 0-9, A (for 10), B (for 11), etc. To convert a binary value (for example, 0100 1100) to a hexadecimal representation, treat the upper and lower four bits separately to produce a two-digit hexadecimal number (in this case, 4C). Use the following table to convert values from binary to hexadecimal.

Scientific Calculator

Another simple way to convert binary to hexadecimal is to use a scientific calculator, such as the one available on the Windows operating systems. For example:

1. On the Windows Start menu, click **Programs -> Accessories -> Calculator**.
2. On the View menu, select **Scientific**. The scientific calculator appears.
3. Click **Bin** (Binary), and type the number you want to convert.

Table D-1 Binary to Hexadecimal Conversion

Decimal	Binary	Hex
0	0000	0
1	0001	1
2	0010	2
3	0011	3
4	0100	4
5	0101	5
6	0110	6
7	0111	7
8	1000	8
9	1001	9
10	1010	A
11	1011	B
12	1100	C
13	1101	D
14	1110	E
15	1111	F

Figure D-2 Windows Scientific Calculator

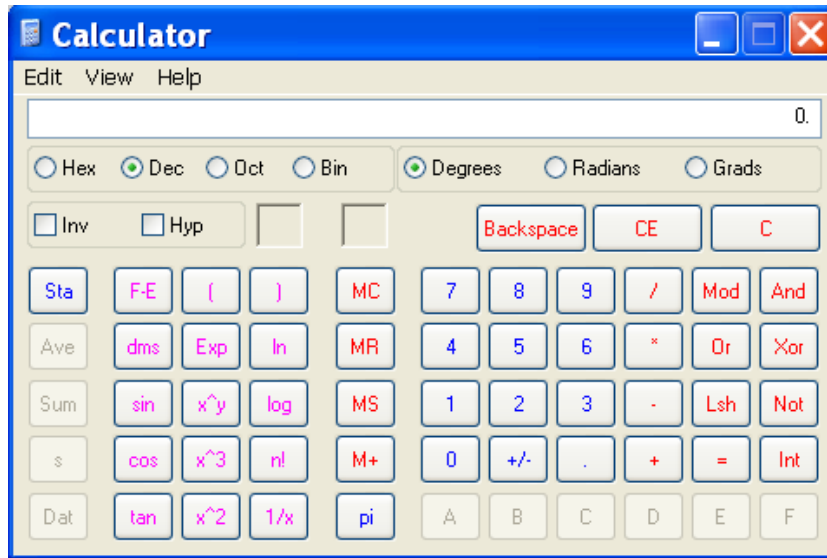

4. Click **Hex**. The hexadecimal value appears.

Figure D-3 Hexadecimal Values in the Scientific Calculator

