

**Single SCR  
POW-R-BLOK™ Modules  
400 Amperes/1200-1600 Volts**

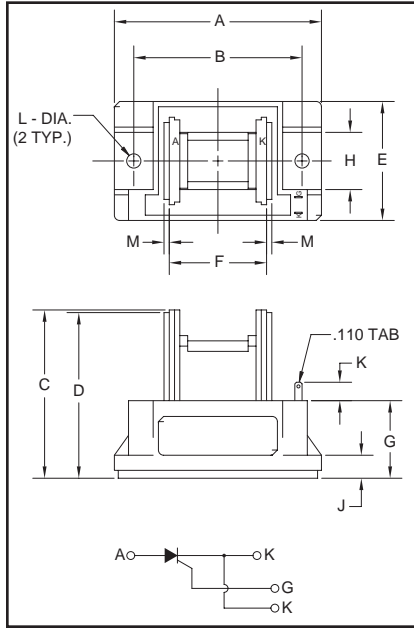

**Outline Drawing**

Dimension	Inches	Millimeters
A	3.15	80
B	2.559±0.012	65±0.3
C	2.56	65
D	2.52	64
E	1.81	46
F	1.38	35
G	1.18	30
H	0.87	22
J	0.35	9
K	0.28	7
L	0.216 Dia.	Dia. 5.5
M	0.08	2



**CSD3120H, CSD3160H  
Single SCR  
POW-R-BLOK™ Modules  
400 Amperes/1200-1600 Volts**

**Description:**

Powerex Single SCR POW-R-BLOK™ Modules are designed for use in applications requiring phase control and isolated packaging. The modules are isolated for easy mounting with other components on common heatsinks.

**Features:**

- Isolated Mounting
- Metal Baseplate
- Low Thermal Impedance

**Applications:**

- Solid State Starters
- By-Pass Switch
- AC and DC Motor Control

**Ordering Information:**

Select the complete eight digit module part number you desire from the table below.

Example: CSD3120H is a 1200 Volt, 400 Ampere Single SCR POW-R-BLOK™ Module.

Type	Voltage Volts (x100)	Current Rating Amperes (400)
CSD3	12 16	0H



Powerex, Inc., 200 Hillis Street, Youngwood, Pennsylvania 15697-1800 (724) 925-7272

**CSD3120H, CSD3160H**  
**Single SCR POW-R-BLOK™ Modules**  
 400 Amperes/1200-1600 Volts

**Absolute Maximum Ratings**

Characteristics	Symbol	CSD3120H	CSD3160H	Units
Peak Forward Blocking Voltage	$V_{DRM}$	1200	1600	Volts
Transient Peak Forward Blocking Voltage (Non-Repetitive) $t < 5ms$	$V_{DSM}$	1350	1700	Volts
DC Forward Blocking Voltage	$V_{D(DC)}$	960	1280	Volts
Peak Reverse Blocking Voltage	$V_{RRM}$	1200	1600	Volts
Transient Peak Reverse Blocking Voltage (Non-Repetitive), $t < 5ms$	$V_{RSM}$	1350	1700	Volts
DC Reverse Blocking Voltage	$V_{R(DC)}$	960	1280	Volts
RMS On-State Current	$I_{T(RMS)}$	620	620	Amperes
Average On-State Current, $T_C = 66^\circ C$	$I_{T(AV)}$	400	400	Amperes
Peak One-Cycle Surge (Non-Repetitive) On-State Current (60Hz)	$I_{TSM}$	8000	8000	Amperes
Peak One-Cycle Surge (Non-Repetitive) On-State Current (50Hz)	$I_{TSM}$	7300	7300	Amperes
$I^2t$ (for Fusing), 8.3 milliseconds	$I^2t$	267,000	267,000	$A^2sec$
Critical Rate-Of-Rise of On-State Current*	$di/dt$	100	100	Amperes/ $\mu s$
Peak Gate Power Dissipation	$P_{GM}$	10	10	Watts
Average Gate Power Dissipation	$P_{G(AV)}$	3	3	Watts
Peak Forward Gate Voltage	$V_{GFM}$	10	10	Volts
Peak Reverse Gate Voltage	$V_{GRM}$	5.0	5.0	Volts
Peak Forward Gate Current	$I_{GFM}$	4.0	4.0	Amperes
Storage Temperature	$T_{STG}$	-40 to 125	-40 to 125	$^\circ C$
Operating Temperature	$T_j$	-40 to 125	-40 to 125	$^\circ C$
Maximum Mounting Torque M5 Mounting Screw	—	17	17	in.-lb.
Maximum Mounting Torque M8 Terminal Screw	—	72	72	in.-lb.
Module Weight (Typical)	—	450	450	Grams
V Isolation	$V_{RMS}$	2500	2500	Volts

\* $T_j = 125^\circ C$ ,  $I_G = 1.0A$ ,  $V_D = 1/2 V_{DRM}$



Powerex, Inc., 200 Hillis Street, Youngwood, Pennsylvania 15697-1800 (724) 925-7272

**CSD3120H, CSD3160H**  
**Single SCR POW-R-BLOK™ Modules**  
400 Amperes/1200-1600 Volts

**Electrical and Thermal Characteristics,  $T_j = 25^\circ\text{C}$  unless otherwise specified**

Characteristics	Symbol	Test Conditions	CSD3120H/CSD3160H	Units
<b>Blocking State Maximums</b>				
Forward Leakage Current, Peak	$I_{\text{DRM}}$	$T_j = 125^\circ\text{C}$ , $V_{\text{DRM}} = \text{Rated}$	40	mA
Reverse Leakage Current, Peak	$I_{\text{RRM}}$	$T_j = 125^\circ\text{C}$ , $V_{\text{RRM}} = \text{Rated}$	40	mA
<b>Conducting State Maximums</b>				
Peak On-State Voltage	$V_{\text{FM}}$	$I_{\text{TM}} = 1200\text{A}$	1.4	Volts
<b>Switching Minimums</b>				
Critical Rate-Of-Rise of Off-State Voltage	dv/dt	$T_j = 125^\circ\text{C}$ , $V_{\text{D}} = 2/3 V_{\text{DRM}}$	500	Volts/ $\mu\text{s}$
<b>Thermal Maximums</b>				
Thermal Resistance, Junction-to-Case	$R_{\theta(\text{J-C})}$	Per Module	0.1	$^\circ\text{C}/\text{Watt}$
Thermal Resistance, Case-to-Sink (Lubricated)	$R_{\theta(\text{C-S})}$	Per Module	0.08	$^\circ\text{C}/\text{Watt}$
<b>Gate Parameters Maximums</b>				
Gate Current to Trigger	$I_{\text{GT}}$	$V_{\text{D}} = 6\text{V}$ , $R_{\text{L}} = 2\Omega$	100	mA
Gate Voltage to Trigger	$V_{\text{GT}}$	$V_{\text{D}} = 6\text{V}$ , $R_{\text{L}} = 2\Omega$	3.0	Volts
Non-Triggering Gate Voltage	$V_{\text{GDM}}$	$T_j = 125^\circ\text{C}$ , $V_{\text{D}} = 1/2 V_{\text{DRM}}$	0.25	Volts

**CSD3120H, CSD3160H**  
**Single SCR POW-R-BLOK™ Modules**  
 400 Amperes/1200-1600 Volts

**MAXIMUM ON-STATE CHARACTERISTICS**

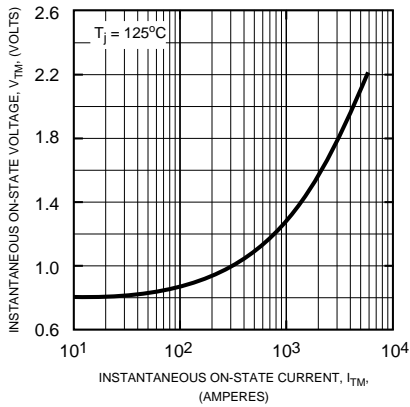

**MAXIMUM ALLOWABLE PEAK SURGE (NON-REPETITIVE) CURRENT**

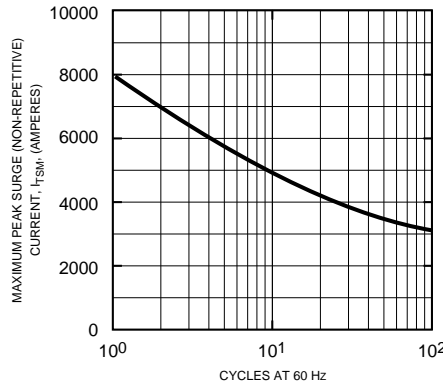

**TRIGGERING CHARACTERISTICS**

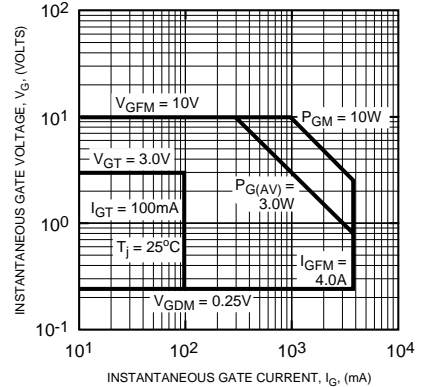

**TRANSIENT THERMAL IMPEDANCE CHARACTERISTICS (JUNCTION-TO-CASE)**

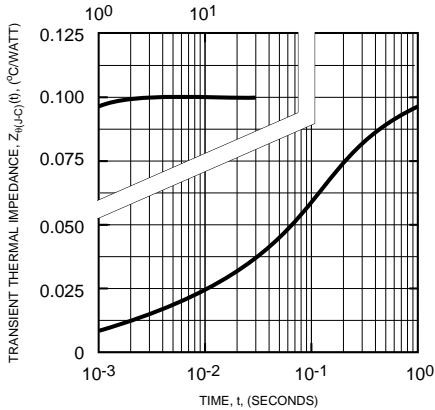

**MAXIMUM ON-STATE POWER DISSIPATION (SINUSOIDAL WAVEFORM)**

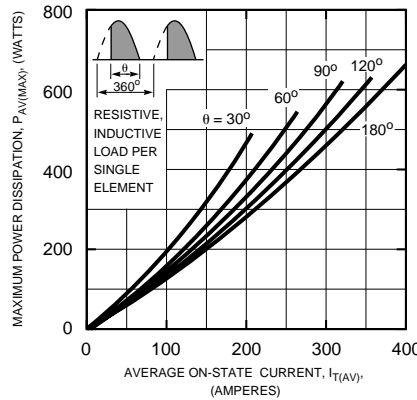

**MAXIMUM ALLOWABLE CASE TEMPERATURE (SINUSOIDAL WAVEFORM)**

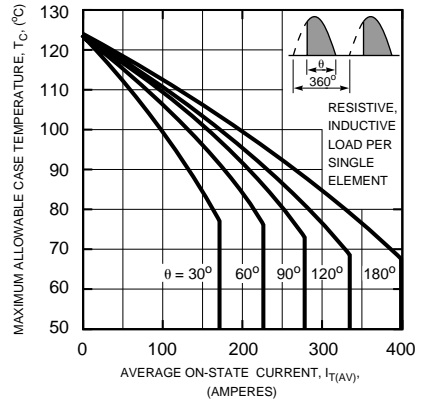

**MAXIMUM AVERAGE ON-STATE POWER DISSIPATION (RECTANGULAR WAVEFORM)**

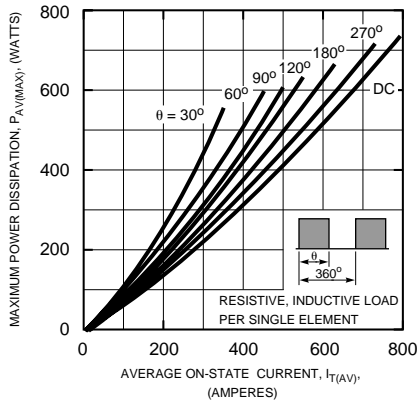

**MAXIMUM ALLOWABLE CASE TEMPERATURE (RECTANGULAR WAVEFORM)**

