

**Model No: NR38150-01W-08**
**Rev : 1.0**

### Product Description

Made of superior materials, wear resistance and good shock resistance, durable small size, high sensitivity, moderate frequency flat

### Mechanical Drawing

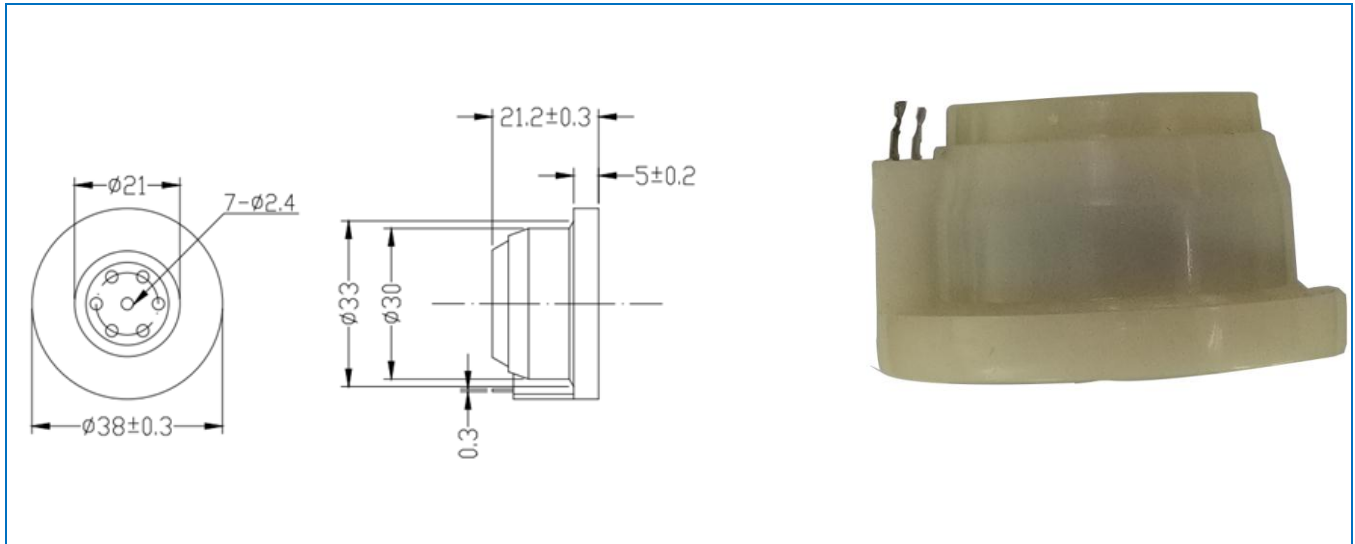

### Specifications

ITEMS	DATA	UNIT	ITEMS	DATA	UNIT
Impedance	150	Ohm	F <sub>0</sub>	/	Hz
Sensitivity	98	dB	Frequency Range	200-5K	Hz
THD	5	%	Weight	35	g
Rated Power	10	mW	Operating Temp	-40~70	°C
Max Power	20	mW			

### Frequency Response Curve

