

LEILA-Y-RS

~10° spot beam. 14.8 mm high assembly with holder, installation tape and pins.

SPECIFICATION:

Dimensions	Ø 21.6 mm
Height	14.8 mm
Fastening	tape, pin
ROHS compliant	yes ⓘ

MATERIALS:

Component	Type	Material	Colour	Finish
LEILA-Y-RS	Single lens	PMMA	clear	gloss
LEILA-Y-HLD	Holder	PC	black	gloss
LEILA-Y-TAPE	Tape	Acrylic foam		

ORDERING INFORMATION:

Component	Qty in box	MOQ	MPQ	Box weight (kg)
CA18089_LEILA-Y-RS » Box size: 476 x 273 x 197 mm	1800	180	180	7.6



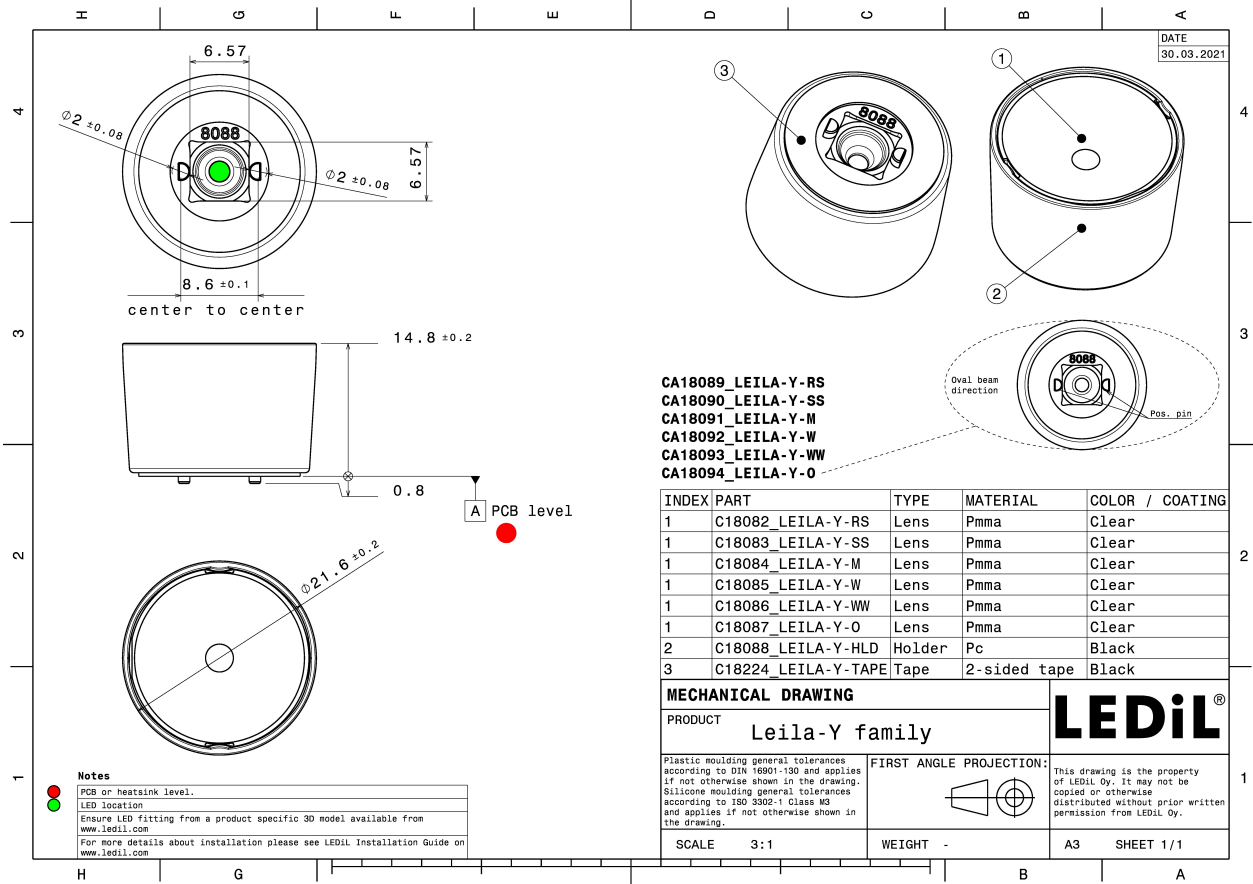





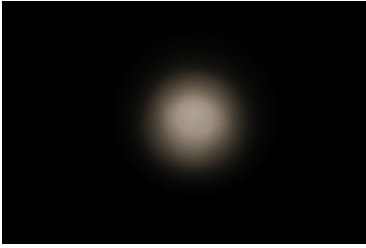
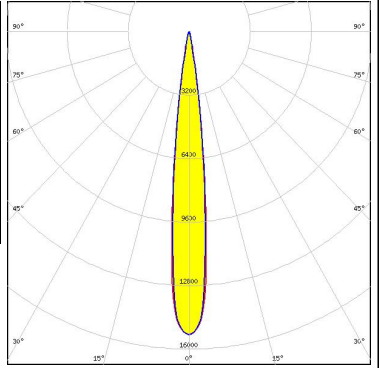
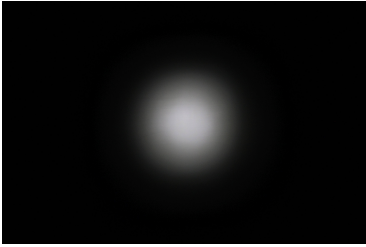
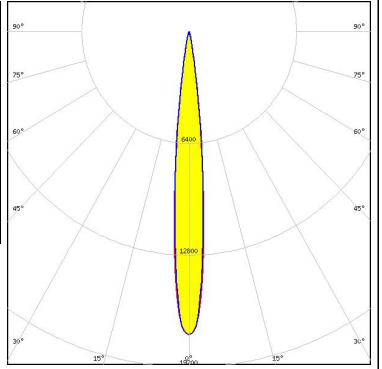

See also our general installation guide: www.ledil.com/installation_guide

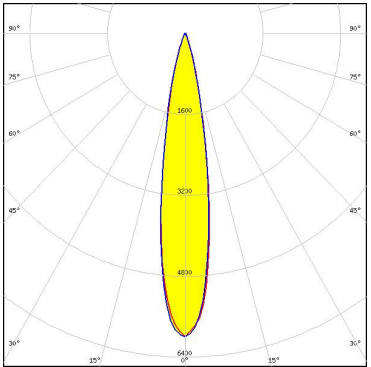

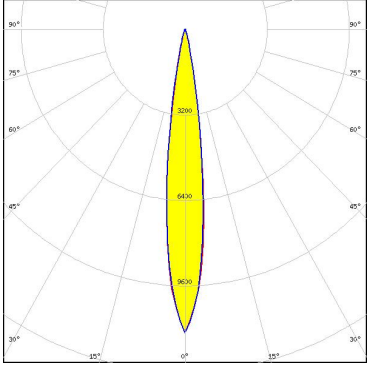

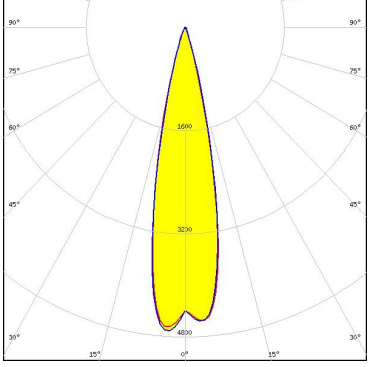

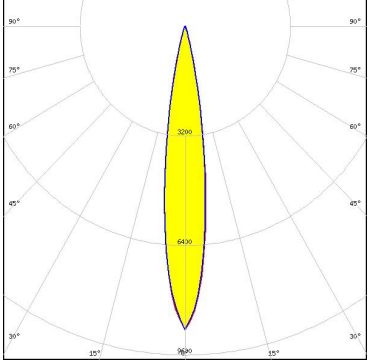
OPTICAL RESULTS (MEASURED):

<p>NICHIA</p> <p>LED NVSW719AC FWHM / FWTM 12.0° / 21.0° Efficiency 87 % Peak intensity 15.3 cd/lm LEDs/each optic 1 Light colour White Required components:</p>		
<p>OSRAM <small>Opto Semiconductors</small></p> <p>LED OSOLON Square CSSRM2/CSSRM3 FWHM / FWTM 11.0° / 20.0° Efficiency 87 % Peak intensity 17.4 cd/lm LEDs/each optic 1 Light colour White Required components:</p>		

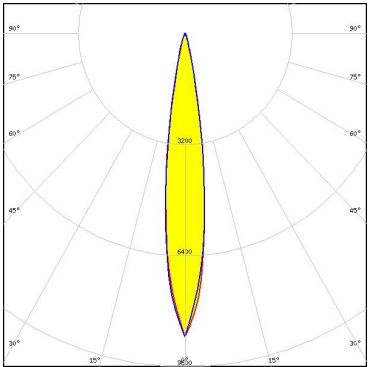
OPTICAL RESULTS (SIMULATED):

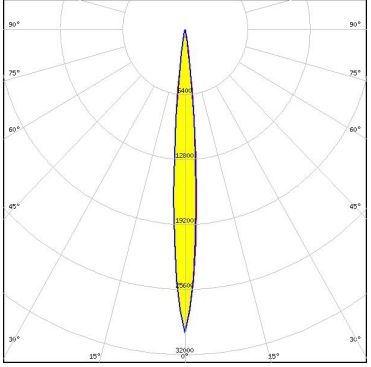
	<p>LED XHP35 HD FWHM / FWTM 18.0° / 35.0° Efficiency 79 % Peak intensity 6 cd/lm LEDs/each optic 1 Light colour White Required components:</p>	
	<p>LED XHP35 HI FWHM / FWTM 14.0° / 26.0° Efficiency 87 % Peak intensity 11.4 cd/lm LEDs/each optic 1 Light colour White Required components:</p>	
	<p>LED XM-L RGBW (XMLDCL HD) FWHM / FWTM 22.0° / 36.0° Efficiency 80 % Peak intensity 4.7 cd/lm LEDs/each optic 1 Light colour RGBW Required components:</p>	
	<p>LED XM-L2 FWHM / FWTM 16.0° / 30.0° Efficiency 85 % Peak intensity 8 cd/lm LEDs/each optic 1 Light colour White Required components:</p>	

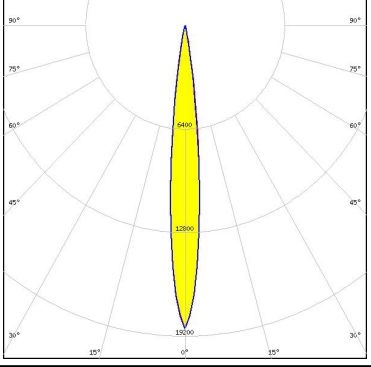

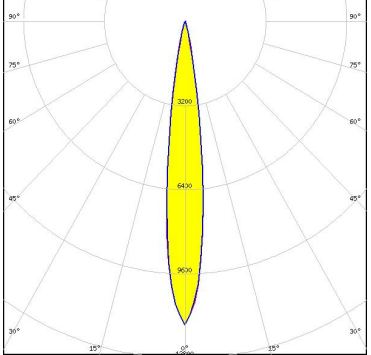



OPTICAL RESULTS (SIMULATED):

	<p>LED XM-L3 FWHM / FWTM 15.0° / 29.0° Efficiency 80 % Peak intensity 8.7 cd/lm LEDs/each optic 1 Light colour White Required components:</p>	
	<p>LED XP-E2 FWHM / FWTM 9.0° / 18.0° Efficiency 91 % Peak intensity 30 cd/lm LEDs/each optic 1 Light colour White Required components:</p>	
	<p>LED XP-G2 FWHM / FWTM 11.0° / 21.0° Efficiency 90 % Peak intensity 19 cd/lm LEDs/each optic 1 Light colour White Required components:</p>	
	<p>LED XP-G3 FWHM / FWTM 13.9° / 25.4° Efficiency 85 % Peak intensity 11.5 cd/lm LEDs/each optic 1 Light colour White Required components:</p>	

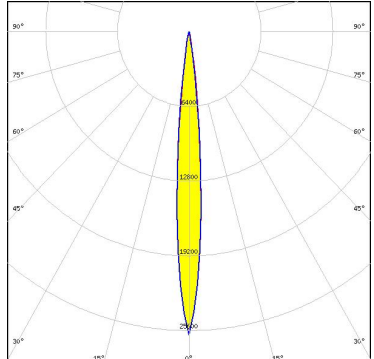
OPTICAL RESULTS (SIMULATED):

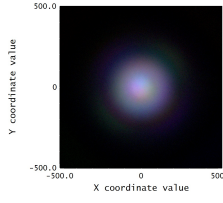
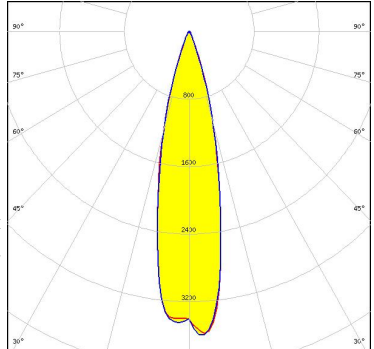
<p>CREE LED</p> <p>LED: XP-L2 FWHM / FWTM: 18.0° / 32.0° Efficiency: 81 % Peak intensity: 7 cd/lm LEDs/each optic: 1 Light colour: White Required components:</p>	
<p>LUMILEDS</p> <p>LED: LUXEON 5050 Round LES FWHM / FWTM: 22.0° / 40.0° Efficiency: 81 % Peak intensity: 4.5 cd/lm LEDs/each optic: 1 Light colour: White Required components:</p>	
<p>LUMILEDS</p> <p>LED: LUXEON 5050 Square LES FWHM / FWTM: 20.0° / 40.0° Efficiency: 81 % Peak intensity: 4.7 cd/lm LEDs/each optic: 1 Light colour: White Required components:</p>	
<p>LUMILEDS</p> <p>LED: LUXEON TX FWHM / FWTM: 12.0° / 23.0° Efficiency: 88 % Peak intensity: 16 cd/lm LEDs/each optic: 1 Light colour: White Required components:</p>	

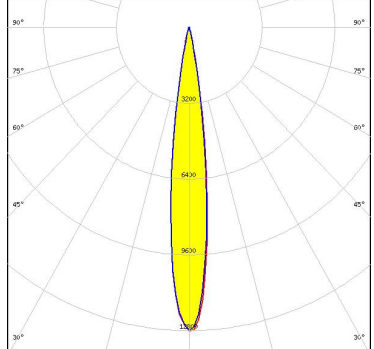
OPTICAL RESULTS (SIMULATED):

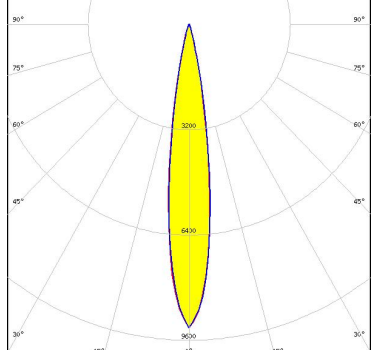
 <p>LED LUXEON Z ES FWHM / FWTM 10.0° / 18.0° Efficiency 90 % Peak intensity 26 cd/lm LEDs/each optic 1 Light colour White Required components:</p>		
 <p>LED NCSxE17A FWHM / FWTM 24.0° / 42.0° Efficiency 76 % Peak intensity 3.6 cd/lm LEDs/each optic 4 Light colour RGBW Required components:</p>	 <p>Detector Image: Illuminance</p> <p>Zeiss Zeiss OptiClickStudio 21.3</p> <p>01.1.2023 Device: 11.4002 Spotfire 01 Device: 11.4002 Spotfire 01 Date: 01/01/2023 11:00:00 Total Power : 2.870040 Lumens</p>	
 <p>LED NVSW219F FWHM / FWTM 14.0° / 25.0° Efficiency 88 % Peak intensity 12 cd/lm LEDs/each optic 1 Light colour White Required components:</p>		
 <p>Opto Semiconductors</p> <p>LED OSCONIQ P 3737 (3W version) FWHM / FWTM 16.0° / 28.0° Efficiency 87 % Peak intensity 9.2 cd/lm LEDs/each optic 1 Light colour White Required components:</p>		

OPTICAL RESULTS (SIMULATED):

OSRAM

Opto Semiconductors

LED OSLON Square CSSRM2/CSSRM3
 FWHM / FWTM 10.0° / 18.0°
 Efficiency 89 %
 Peak intensity 24.9 cd/lm
 LEDs/each optic 1
 Light colour Far Red
 Required components:

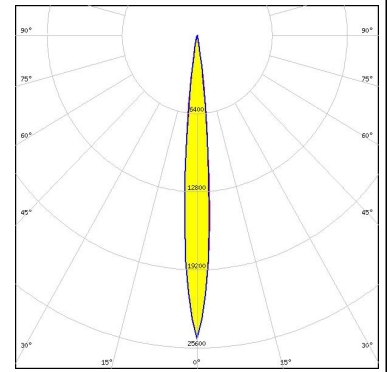

OSRAM

Opto Semiconductors

LED OSLON Square Flat
 FWHM / FWTM 10.0° / 20.0°
 Efficiency 90 %
 Peak intensity 22.6 cd/lm
 LEDs/each optic 1
 Light colour White
 Required components:

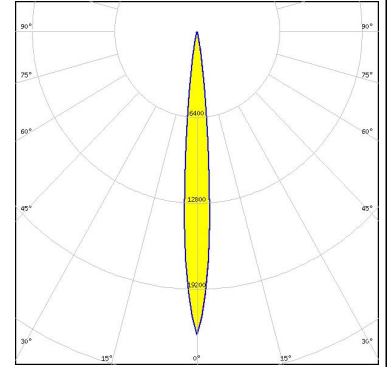

OSRAM

Opto Semiconductors

LED OSLON SSL 150
 FWHM / FWTM 9.0° / 18.0°
 Efficiency 91 %
 Peak intensity 27 cd/lm
 LEDs/each optic 1
 Light colour White
 Required components:

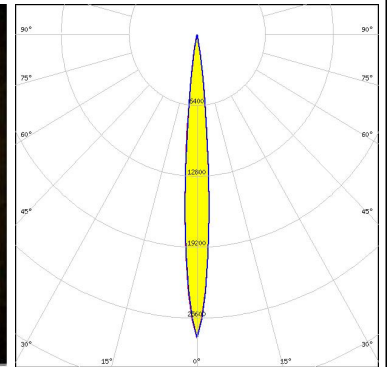

SAMSUNG

LED LH351B
 FWHM / FWTM 13.0° / 24.0°
 Efficiency 86 %
 Peak intensity 13 cd/lm
 LEDs/each optic 1
 Light colour White
 Required components:

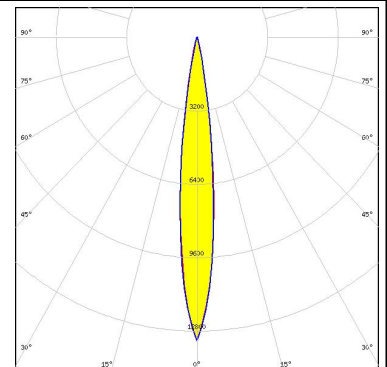

OPTICAL RESULTS (SIMULATED):



GENERAL INFORMATION:

NOTE: The typical beam angle will be changed by different color, chip size and chip position tolerance. The typical total beam angle is the full angle measured where the luminous intensity is half of the peak value.

MATERIALS:

As part of our continuous research and improvement processes, and to ensure the best possible quality and availability of our products, LEDiL reserves the right to change material grades without notice.

PRODUCT DATA USER AGREEMENT AND DISCLAIMER:

The measured data in the provided downloadable LEDiL Product Datasheets and Mechanical 2D-Drawings is rounded and provided as reference for planning. LEDiL Oy's optical specifications have been verified by conducting performance testing of the products in accordance with the company's quality system. The reported data are averaged results of multiple measurements with typical variation. LEDiL Oy reserves the right to without prior notification make changes and improvements to its products.

LEDiL Oy assumes neither warranty, nor guarantee nor any other liability of any kind for the contents and correctness of the provided data. The provided data has been generated with highest diligence but the provided data may in reality not represent the complete possible variation range of all intrinsic parameters. Therefore, in certain cases a deviation from the provided data could occur.

LEDiL Oy reserves the right to undertake technical changes of its products without further notification which could lead to changes in the provided data. LEDiL Oy assumes no liability of any kind for the possible deviation from any provided data or any other damage resulting from the usage of the provided data.

The user agrees to this disclaimer and user agreement with the download or usage of the provided files.

LEDiL Oy

Joensuunkatu 13
FI-24240 SALO
Finland

LEDiL Inc.

228 West Page Street
Suite D
Sycamore IL 60178
USA

Ledil Optics Technology (Shenzhen) Co., Ltd.

405 , Block B
Casic Motor Building
Shenzhen 518057
P.R.CHINA

Local sales and technical support

[www.ledil.com/
where_to_buy](http://www.ledil.com/where_to_buy)

Shipping locations

Salo, Finland
Hong Kong, China

Distribution Partners

[www.ledil.com/
where_to_buy](http://www.ledil.com/where_to_buy)