

# General Specifications

## Electrical Capacity (Resistive Load)

**Logic Level:** 0.4VA maximum @ 28V AC/DC maximum  
 (Applicable Range 0.1mA ~ 0.1A @ 20mV ~ 28V)  
 Note: Find additional explanation of operating range in Supplement section

## Other Ratings

**Contact Resistance:** 100 milliohms maximum  
**Insulation Resistance:** 100 megohms minimum @ 500V DC  
**Dielectric Strength:** 500V AC minimum for 1 minute minimum  
**Mechanical Life:** 30,000 cycles minimum  
**Electrical Life:** 20,000 cycles minimum  
**Static Capability:** Withstands 15 kilovolts ESD  
**Nominal Operating Torque:** .0002Nm (.0017 lb•in)  
**Contact Timing:** Break-before-make  
**Angle of Throw:** 45° for 3-position & 5-position

## Materials & Finishes

**Key:** Polyacetal  
**Housing/Bushing:** Glass fiber reinforced polyester (PBT)  
**Base:** Glass fiber reinforced polyamide  
**Rotor & Stopper:** Polyacetal  
**Tumbler Plate:** Brass  
**Movable Contactor:** Beryllium copper with gold plating  
**Stationary Contacts:** Phosphor bronze with gold plating  
**Terminals:** Phosphor bronze with gold plating  
**Mounting Bracket:** Steel with tin plating

## Environmental Data

**Operating Temperature Range:** -25°C through +70°C (-13°F through +158°F)  
**Humidity:** 90 ~ 95% humidity for 240 hours @ 40°C (104°F)  
**Vibration:** 10 ~ 55Hz with peak-to-peak amplitude of 1.5mm traversing the frequency range & returning in 1 minute; 3 right angled directions for 2 hours  
**Shock:** 50G (490m/s<sup>2</sup>) acceleration (tested in 6 right angled directions, with 5 shocks in each direction)

## PCB Processing

**Soldering:** Wave Soldering Recommended. See Profile A in Supplement section.  
 Manual Soldering: See Profile A in Supplement section.  
**Cleaning:** Automated cleaning. See Cleaning specifications in Supplement section.

## Standards & Certifications

The SK Series devices have not been tested for UL recognition or CSA certification. These switches are designed for use in a low-voltage, low-current, logic-level circuit. When used as intended in a logic-level circuit, the results do not produce hazardous energy.

Toggles

Rockers

Pushbuttons

Illuminated PB

Programmable

**F**  
Keylocks

Rotaries

Slides

Tactiles

Tilt

Touch

Indicators

Accessories

Supplement

# Distinctive Characteristics

Housing and bushing of high insulating material withstands over 15 kilovolts of electrostatic discharge, thus providing antistatic protection.

Totally sealed construction with internal o-ring, with gasket between base and housing, and with insert-molded terminals, gives protection for automated processing techniques.

Subminiature size allows high density mounting.

Molded-in terminals prevent entry of flux and other contaminants.

Crimped bracket legs ensure secure PCB mounting and prevent dislodging during automated wave soldering.

Bifurcated, self-wiping contact mechanism provides unequalled logic-level reliability and smoother, positive detent actuation.

Detent mechanism, with its spring-operated steel ball, gives distinct feel and crisp actuation for accurate switch setting.

.100" x .100" (2.54mm x 2.54mm) terminal spacing conforms to standard PC board grid spacing.



Actual Size

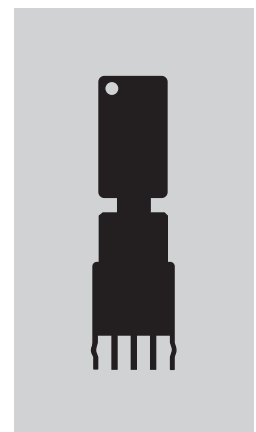

TYPICAL SWITCH ORDERING EXAMPLE

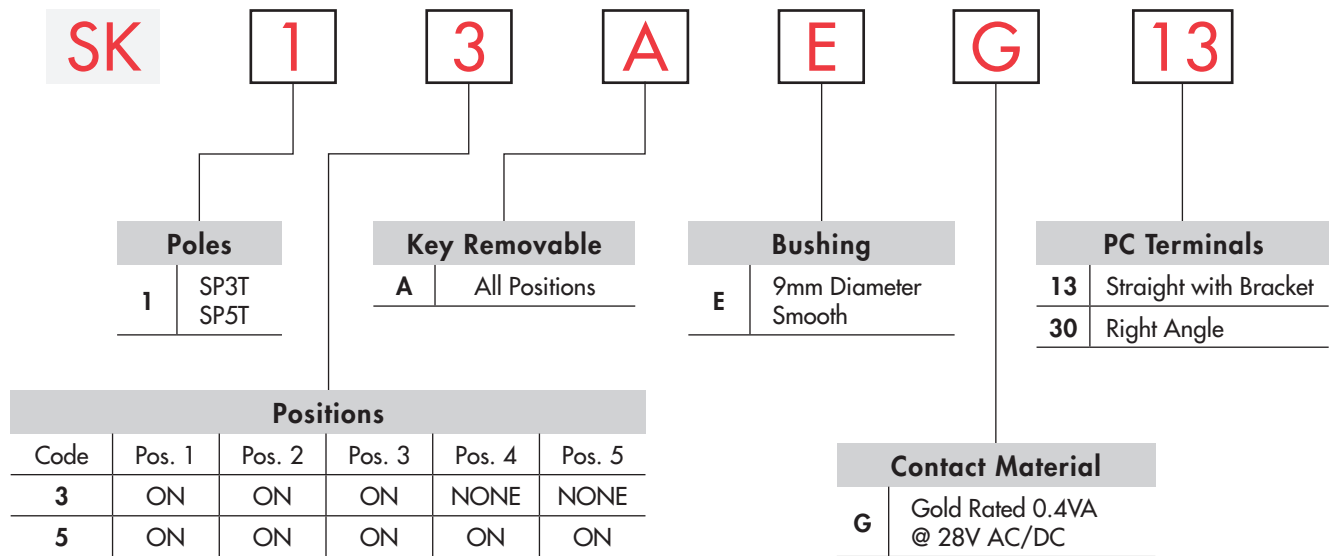

DESCRIPTION FOR TYPICAL ORDERING EXAMPLE

SK13AEG13

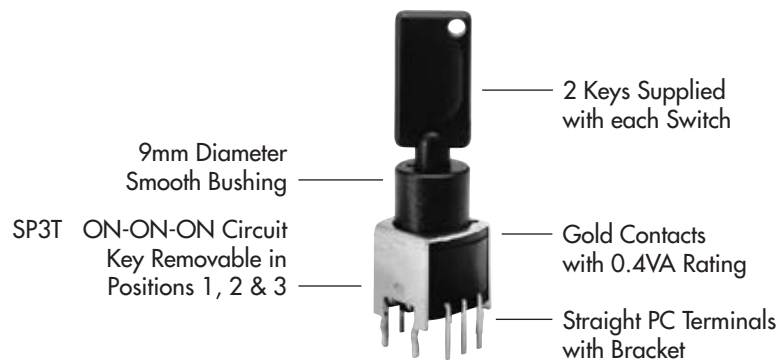

POLES, CIRCUITS & KEY-REMOVABLE POSITIONS

Pole & Throw	Model	Key Positions					Connected Terminals (Terminal numbers are not on switch)					Schematic	⊙ = Key Removable ● = Not Removable ✓ = Maximum Arc
		Pos 1	Pos 2	Pos 3	Pos 4	Pos 5	Pos 1	Pos 2	Pos 3	Pos 4	Pos 5		
SP3T	SK13A	ON	ON	ON	----	----	C1-2	C1-3	C1-4	----	----		
SP5T	SK15A	ON	ON	ON	ON	ON	C1-1	C1-2	C1-3	C1-4	C1-5		

KEY REMOVABLE

BUSHING

**A** All Positions  
45° Angular Throw

**E** 9mm Diameter Smooth

Toggles  
Rockers  
Pushbuttons  
Illuminated PB  
Programmable  
Keylocks  
Rotaries  
Slides  
Tactiles  
Tilt  
Touch  
Indicators  
Accessories  
Supplement

## CONTACT MATERIAL & RATING

**G**

Gold over Bronze or Copper

Logic Level

0.4VA @ 28V AC/DC maximum

## TERMINALS

**13**

Straight PC with Bracket

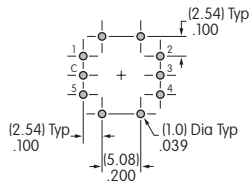
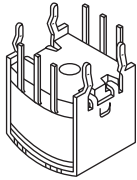

**30**

Right Angle PC

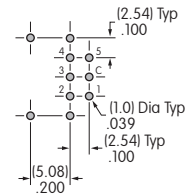
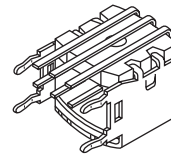

## KEY

**AT4094**  
Tubular Key

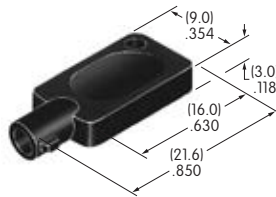

Material: Polyacetal

2 keys provided with each switch

## TYPICAL SWITCH DIMENSIONS

Straight PC with Bracket

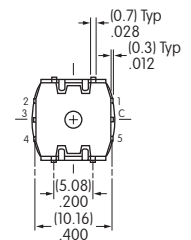
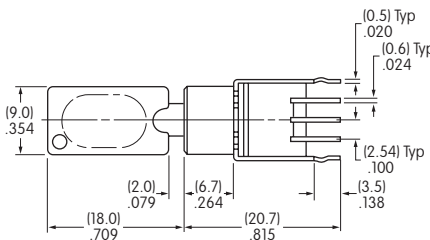
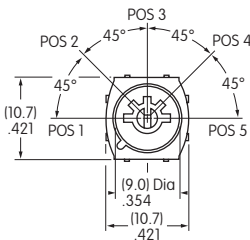
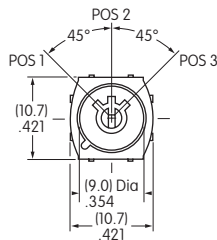

**SK13AEG13**

3 Position

5 Position

On 3-position models terminals 1 & 5 are support pins.

Right Angle PC

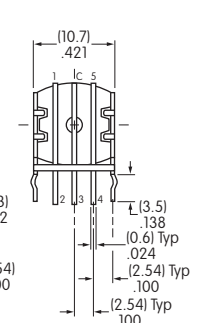
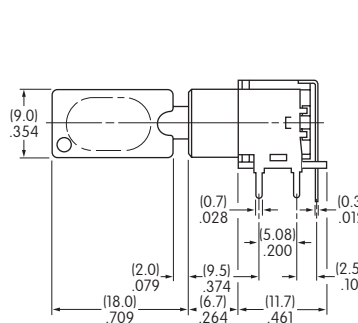
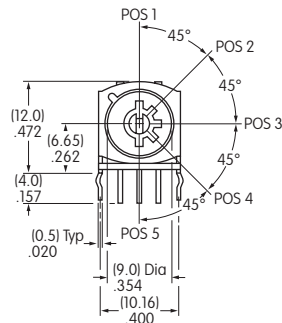
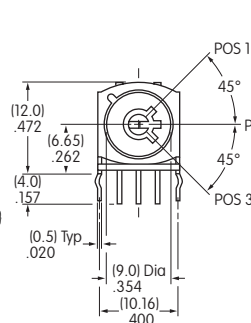

**SK15AEG30**

3 Position

5 Position

On 3-position models terminals 1 & 5 are support pins.