

## EVA-M

~25° medium beam

### TECHNICAL SPECIFICATIONS:

Dimensions	Ø 35.0 mm
Height	16.4 mm
Fastening	glue
ROHS compliant	yes ⓘ

### MATERIAL SPECIFICATIONS:

Component	Type	Material	Colour	Finish
EVA-M	Single lens	PMMA	clear	

### ORDERING INFORMATION:

Component	Qty in box	MOQ	MPQ	Box weight (kg)
C10685_EVA-M » Box size: 480 x 280 x 300 mm	540	90	45	5.8



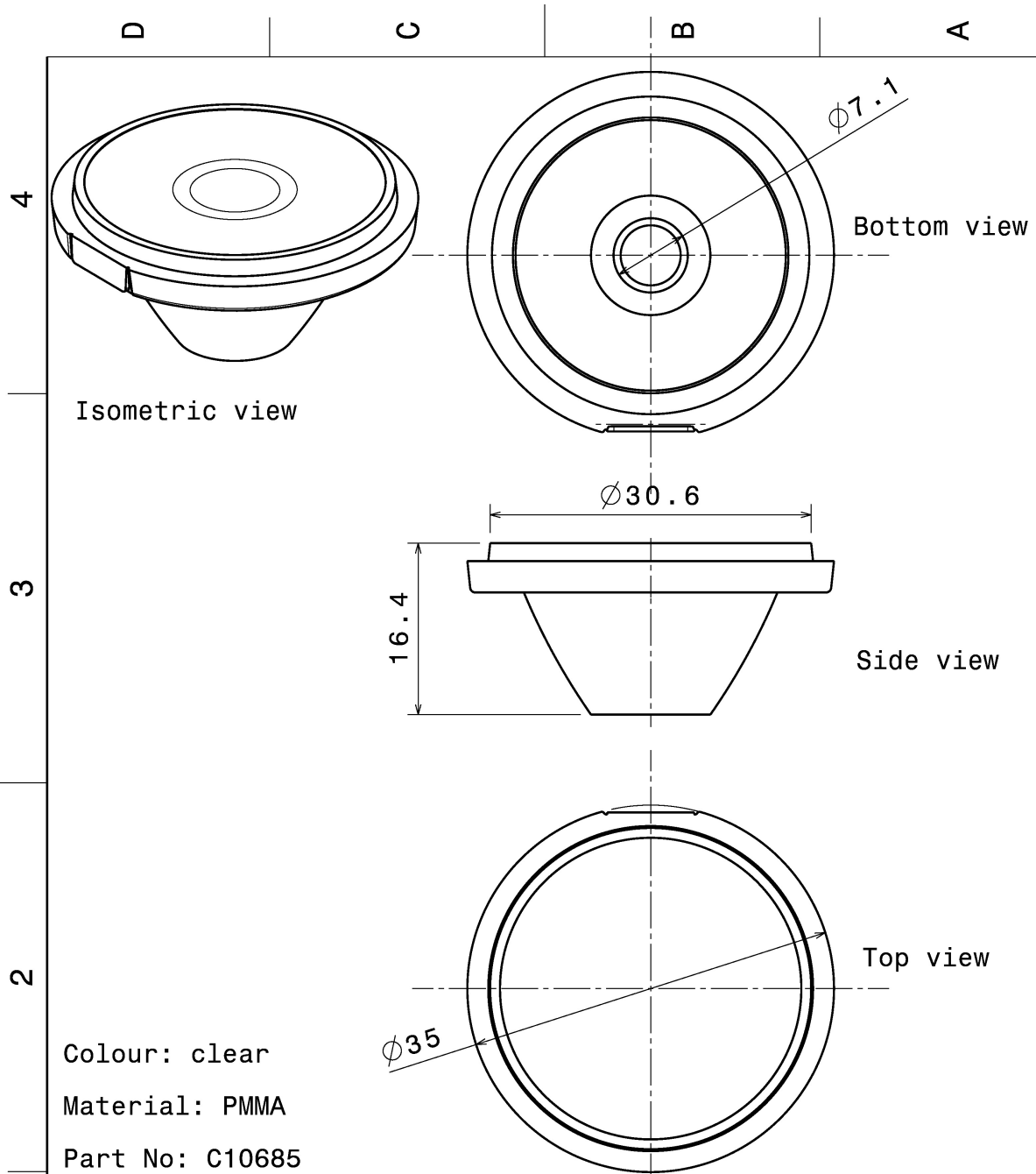

This drawing is our property.  
It can't be reproduced  
or communicated without  
our written agreement.



Ledil Oy  
Joensuukatu 13  
FIN-24100 SALO  
Finland

DRAWING TITLE

Datasheet Eva Medium Lens

DRAWN BY PV	DATE 05.09.2008	DRAWING TITLE Datasheet Eva Medium Lens			REV 1.0
	CHECKED BY hh	DATE 04.09.2008	SIZE A4	DRAWING NUMBER C10685	
DESIGNED BY HH	DATE 26.08.2008	SCALE 2:1	WEIGHT (g)	SHEET 1/1	

See also our general installation guide: [www.ledil.com/installation\\_guide](http://www.ledil.com/installation_guide)

### PHOTOMETRIC DATA (MEASURED):

#### CITIZEN

LED CLU7A2 (LES 4.2mm)  
 FWHM / FWTM 22.0° / 44.0°  
 Efficiency 89 %  
 Peak intensity 4.2 cd/lm  
 LEDs/each optic 1  
 Light colour White  
 Required components:

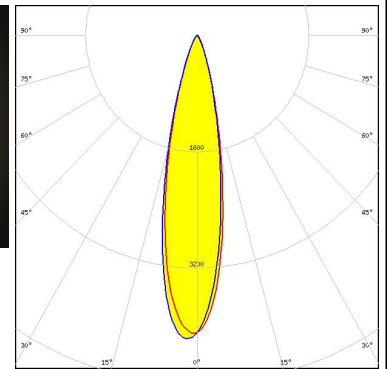
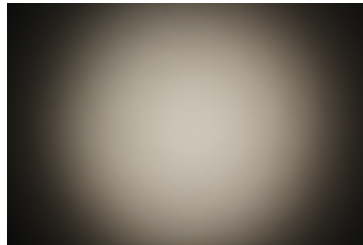

#### CREE

LED MC-E  
 FWHM / FWTM 22.0°  
 Efficiency 89 %  
 Peak intensity 3 cd/lm  
 LEDs/each optic 1  
 Light colour White  
 Required components:

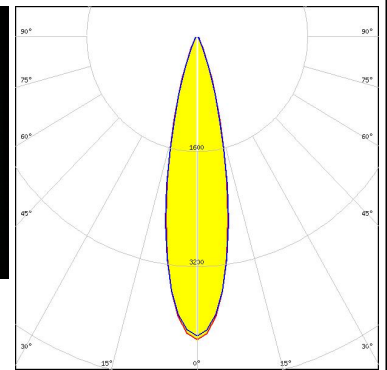

#### CREE

LED MHB-A/B  
 FWHM / FWTM 25.0° / 50.0°  
 Efficiency 82 %  
 Peak intensity 3.6 cd/lm  
 LEDs/each optic 1  
 Light colour White  
 Required components:

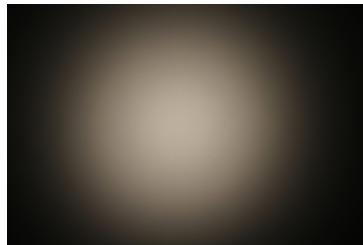

#### CREE

LED XHP35 HI  
 FWHM / FWTM 28.0° / 56.0°  
 Efficiency 78 %  
 Peak intensity 2.3 cd/lm  
 LEDs/each optic 1  
 Light colour White  
 Required components:

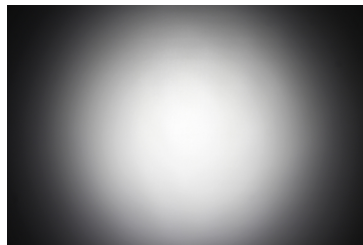

### PHOTOMETRIC DATA (MEASURED):

#### CREE

LED XM-L  
 FWHM / FWTM 24.0°  
 Efficiency 88 %  
 LEDs/each optic 1  
 Light colour White  
 Required components:

#### CREE

LED XP-G2  
 FWHM / FWTM 24.0° / 42.0°  
 Efficiency 88 %  
 Peak intensity 4.2 cd/lm  
 LEDs/each optic 1  
 Light colour White  
 Required components:



#### CREE

LED XT-E  
 FWHM / FWTM 24.0°  
 Efficiency %  
 Peak intensity 3.7 cd/lm  
 LEDs/each optic 1  
 Light colour White  
 Required components:

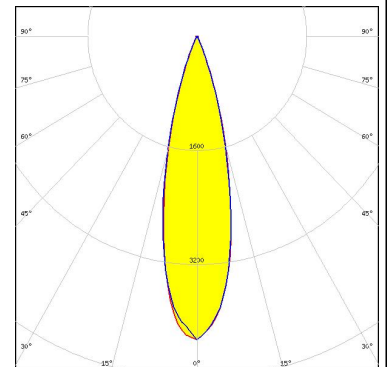

#### LUMILEDS

LED LUXEON 5050 Round LES  
 FWHM / FWTM 25.0° / 49.0°  
 Efficiency 85 %  
 Peak intensity 3.3 cd/lm  
 LEDs/each optic 1  
 Light colour White  
 Required components:

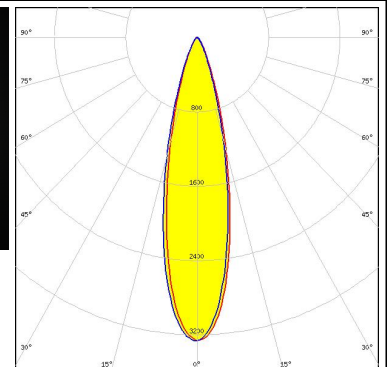
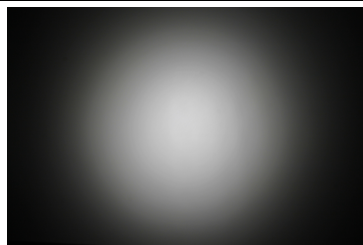

### PHOTOMETRIC DATA (MEASURED):

#### LUMILEDS

LED LUXEON M/MX  
 FWHM / FWTM 26.0°  
 Efficiency 89 %  
 Peak intensity 2.8 cd/lm  
 LEDs/each optic 1  
 Light colour White  
 Required components:

#### LUMILEDS

LED LUXEON MZ  
 FWHM / FWTM 24.0° / 44.0°  
 Efficiency 87 %  
 Peak intensity 4.2 cd/lm  
 LEDs/each optic 1  
 Light colour White  
 Required components:

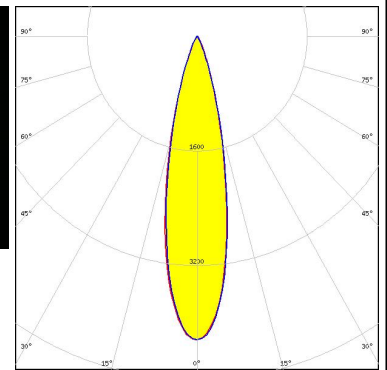
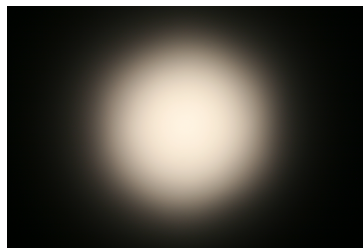

#### NICHIA

LED NS9x383  
 FWHM / FWTM 24.0° / 46.0°  
 Efficiency 88 %  
 Peak intensity 3.7 cd/lm  
 LEDs/each optic 1  
 Light colour White  
 Required components:

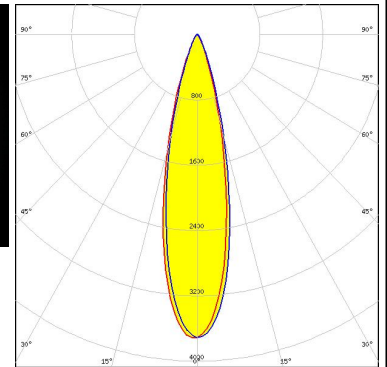
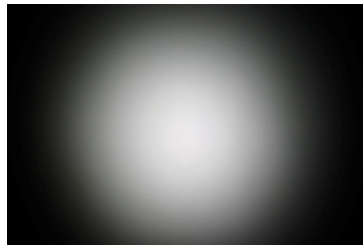

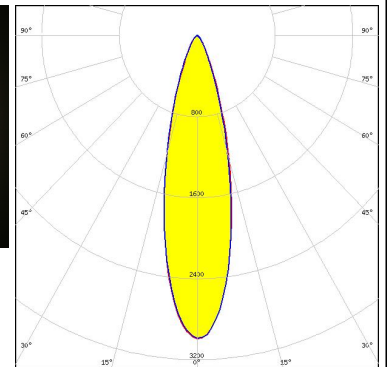
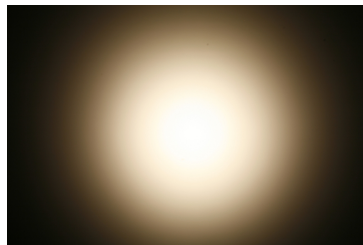

#### NICHIA

LED NSMx286M  
 FWHM / FWTM 26.0° / 52.0°  
 Efficiency 88 %  
 Peak intensity 3 cd/lm  
 LEDs/each optic 1  
 Light colour White  
 Required components:

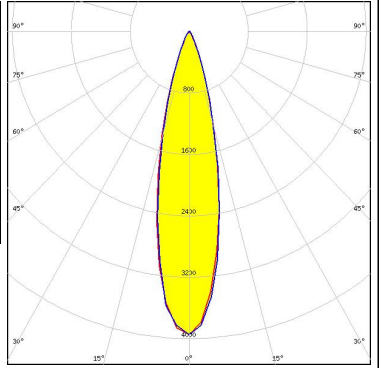

### PHOTOMETRIC DATA (MEASURED):

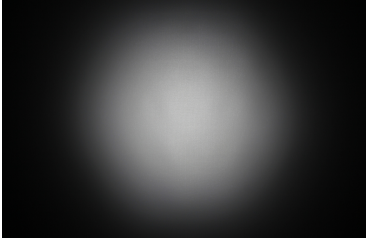
<p><b>OSRAM</b> Opto Semiconductors</p> <p>LED Duris S8</p> <p>FWHM / FWTM 25.0° / 46.0°</p> <p>Efficiency 86 %</p> <p>Peak intensity 4 cd/lm</p> <p>LEDs/each optic 1</p> <p>Light colour White</p> <p>Required components:</p>		
<p><b>SEOUL SEMICONDUCTOR</b></p> <p>LED Z8Y15</p> <p>FWHM / FWTM 24.0° / 43.0°</p> <p>Efficiency 83 %</p> <p>Peak intensity 4.3 cd/lm</p> <p>LEDs/each optic 1</p> <p>Light colour White</p> <p>Required components:</p>		
<p><b>SEOUL SEMICONDUCTOR</b></p> <p>LED Z8Y19</p> <p>FWHM / FWTM 24.0° / 43.0°</p> <p>Efficiency 84 %</p> <p>Peak intensity 4.2 cd/lm</p> <p>LEDs/each optic 1</p> <p>Light colour White</p> <p>Required components:</p>		

### PHOTOMETRIC DATA (SIMULATED):

#### CITIZEN

LED CLU700/701/702  
FWHM / FWTM 28.0° / 53.0°  
Efficiency 93 %  
Peak intensity 3.2 cd/lm  
LEDs/each optic 1  
Light colour White  
Required components:

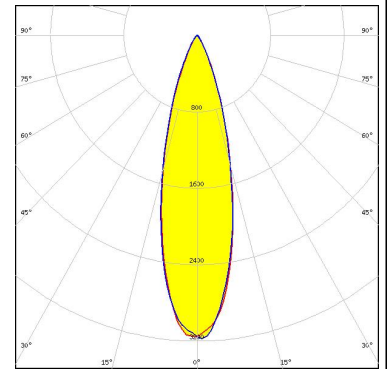

#### CREE

LED XM-L HVW  
FWHM / FWTM 26.0°  
Efficiency %  
LEDs/each optic 1  
Light colour White  
Required components:

#### LUMILEDS

LED LUXEON 5258  
FWHM / FWTM 24.0° / 44.0°  
Efficiency 93 %  
Peak intensity 4.3 cd/lm  
LEDs/each optic 1  
Light colour White  
Required components:

#### LUMINUS

LED CXM-3  
FWHM / FWTM 26.0° / 44.0 + 46.0°  
Efficiency 94 %  
Peak intensity 4.3 cd/lm  
LEDs/each optic 1  
Light colour White  
Required components:

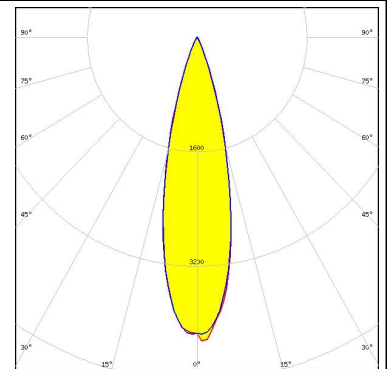

### PHOTOMETRIC DATA (SIMULATED):



LED CXM-4  
FWHM / FWTM 26.0° / 48.0°  
Efficiency 94 %  
Peak intensity 3.8 cd/lm  
LEDs/each optic 1  
Light colour White  
Required components:

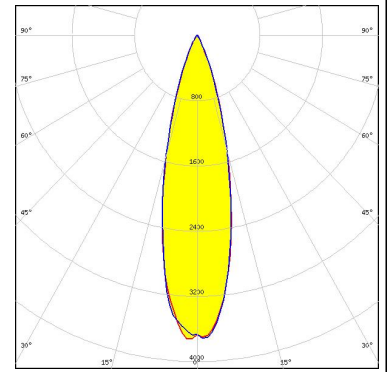

LED OSCONIQ P 7070  
FWHM / FWTM 25.0° / 46.0°  
Efficiency 93 %  
Peak intensity 3.8 cd/lm  
LEDs/each optic 1  
Light colour White  
Required components:

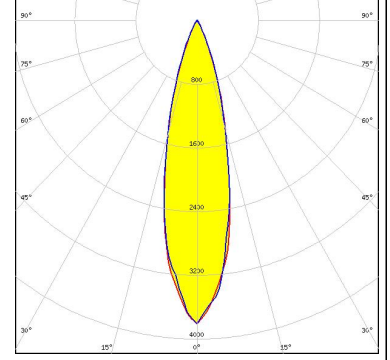



### GENERAL INFORMATION:

NOTE: The typical beam angle will be changed by different color, chip size and chip position tolerance. The typical total beam angle is the full angle measured where the luminous intensity is half of the peak value.

Due to use of high power COB's with this product, special attention to proper thermal design is highly recommended. LEDiL has no liability for direct, indirect or consecutive damages arising from the LEDiL products being used outside of the recommended temperature range.

### MATERIALS:

As part of our continuous research and improvement processes, and to ensure the best possible quality and availability of our products, LEDiL reserves the right to change material grades without notice.

### PRODUCT DATA USER AGREEMENT AND DISCLAIMER:

The measured data in the provided downloadable LEDiL Product Datasheets and Mechanical 2D-Drawings is rounded and provided as reference for planning. LEDiL Oy's optical specifications have been verified by conducting performance testing of the products in accordance with the company's quality system. The reported data are averaged results of multiple measurements with typical variation. LEDiL Oy reserves the right to without prior notification make changes and improvements to its products.

LEDiL Oy assumes neither warranty, nor guarantee nor any other liability of any kind for the contents and correctness of the provided data. The provided data has been generated with highest diligence but the provided data may in reality not represent the complete possible variation range of all intrinsic parameters. Therefore, in certain cases a deviation from the provided data could occur.

LEDiL Oy reserves the right to undertake technical changes of its products without further notification which could lead to changes in the provided data. LEDiL Oy assumes no liability of any kind for the possible deviation from any provided data or any other damage resulting from the usage of the provided data.

The user agrees to this disclaimer and user agreement with the download or usage of the provided files.

#### LEDiL Oy

Joensuunkatu 13  
FI-24240 SALO  
Finland

#### LEDiL Inc.

228 West Page Street  
Suite D  
Sycamore IL 60178  
USA

#### Ledil Optics Technology (Shenzhen) Co., Ltd.

# 405 , Block B  
Casic Motor Building  
Shenzhen 518057  
P.R.CHINA

#### Local sales and technical support

[www.ledil.com/  
where\\_to\\_buy](http://www.ledil.com/where_to_buy)

#### Shipping locations

Salo, Finland  
Hong Kong, China

#### Distribution Partners

[www.ledil.com/  
where\\_to\\_buy](http://www.ledil.com/where_to_buy)