

Complete and reliable solar circuit protection

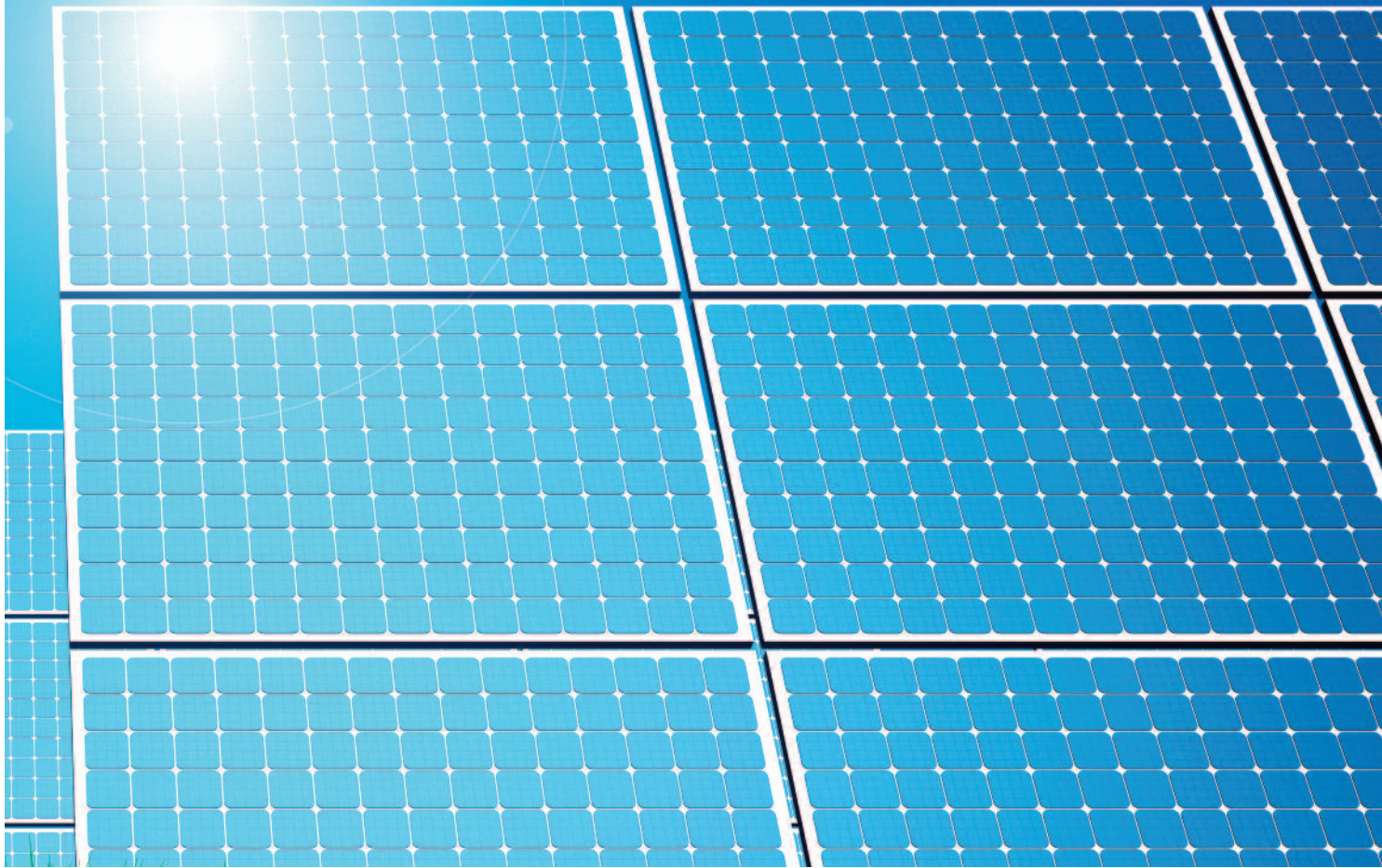

Powering Business Worldw

Benefits of Eaton's circuit protection solutions

Complete and reliable circuit protection for photovoltaic (PV) balance-of-system

Eaton offers the industry's most complete and reliable circuit protection for PV balance of system, from Bussmann® series fuses and fuse holders, and Eaton circuit breakers to safety switches and surge protection—we can provide comprehensive overcurrent and overvoltage protection anywhere in the PV system.

Unmatched global offering

Eaton offers a range of solar products with ratings up to 1500Vdc as well as UL®, IEC®, CSA® and CCC certifications specific for PV applications—ensuring fully supported and seamless global installations.

Legacy of technical expertise

For more than 100 years, Eaton has protected equipment and businesses from electrical hazards. We are the experts in safe system design and application. Our team of Application Engineers and Sales Engineers are dedicated to protecting your system, from specification to delivery. Additionally, the Bussmann Division's *Paul P. Gubany Center for High Power Technology* is one of the industry's most comprehensive testing facilities, and is available to test your systems to global agency standards.

Safe. Reliable. Complete.

Over the last 50 years, solar PV systems have evolved into a mature, sustainable and adaptive technology.

The unique nature of PV system power generation necessitates the need for new and effective electrical protection products for overcurrent, overvoltage and isolation events.

With an Eaton protected electrical system, you can optimize your renewable energy power generation capacity, knowing your equipment is safe. We are a single source for the entire AC and DC circuit protection and disconnecting means. We work closely with solar equipment manufacturers and, through coordinated research and development, have produced revolutionary new fuses and circuit breakers that, combined with a range of surge protective devices, offer complete protection for PV systems.

As a single source provider with over 100 years of proven technology, we provide complete circuit protection solutions that are safe and reliable so you can take full advantage of converting sunlight into usable energy while working with a bankable, industry-leading manufacturer.

Learn more at www.cooperbussmann.com/solar and www.eaton.com/solar.

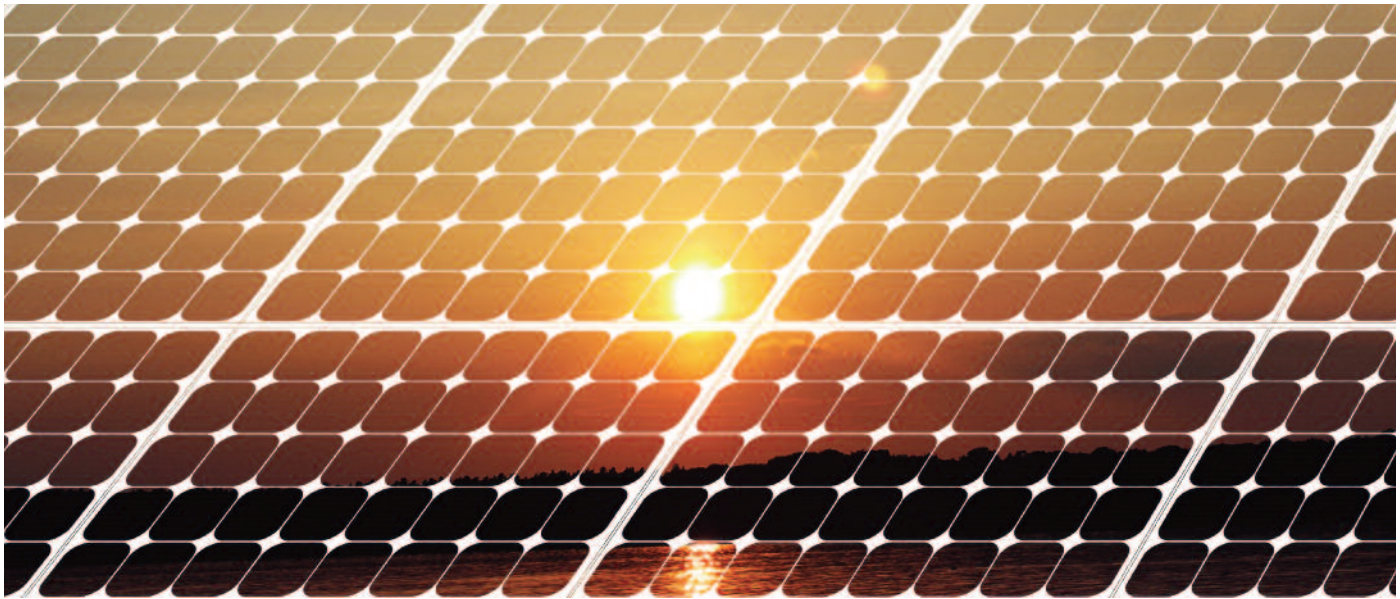

Eaton has a complete portfolio of solar circuit protection solutions to meet your needs

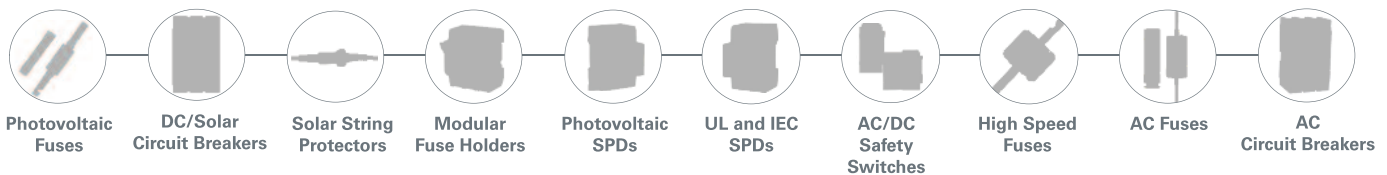

Introduction

Benefits of Eaton’s circuit protection solutions.....	2
---	---

Protecting PV systems

Circuit breaker and fuse protected PV distribution network overviews	4-5
PV system standards	6
PV fuses	6
PV molded case circuit breakers	6
PV array construction	6
PV source circuits	6

Protecting PV systems — source circuits

PV source circuit protection overview	7
NEC® 2014 article 690.12 Rapid Shutdown.....	7
Component standards and ratings	8
Selecting fuses for PV source circuits.....	8
Example.....	9

Protecting PV systems — output circuits

PV output circuit and inverter input circuit protection overview.....	10
Selecting fuses for PV output circuits.....	10
Example.....	11
Selecting PV circuit breakers for PV output circuits .	12

PV product overview

Bussmann series PV fuses.....	14
Bussmann series PV fuse holders and blocks.....	15

Bussmann series 600V PV fuses

10x38mm PVM — 600Vdc, 4-30A.....	16
RK5 PVS-R — 600Vdc, 20-400A	17

Bussmann series 1000V PV fuses

10x38mm — 1000Vdc, 1-30A.....	18
14x51mm — 1000/1100Vdc, 15-32A.....	19
NH sizes 1, 2 and 3 — 1000Vdc, 32-400A.....	20
XL sizes 01, 1, 2, L3 — 1000Vdc, 63-630A.....	21

Bussmann series 1500V PV fuses

14x65mm — 1300/1500Vdc, 2.25-4A and 15-32A.....	22
XL sizes 01, 1, 2, L3 — 1500Vdc, 50-400A.....	23

Bussmann series in-line PV fuses

HPV fuse assembly — 1000Vdc, 1-20A	24
--	----

Eaton DC molded case circuit breakers and switches

600Vdc and 1000Vdc PV molded case circuit breakers.....	25-27
600Vdc general purpose molded case circuit breakers.....	28-29

Bussmann series DIN-Rail PV surge protective devices

600/1000/1200Vdc overvoltage SPDs, 1000Vdc lightning arrester SPD	30-32
---	-------

Bussmann series Quik-Spec™ Coordination Panelboards

Fusible branch circuit panelboards for use on the AC side of large systems utilizing string inverters	33
---	----

Eaton reference materials

Bussmann series and Eaton product reference materials and application guides	33
--	----

More Eaton products for PV systems

Balance-of-system products for PV systems.....	35
--	----

Protecting PV systems

How PV power systems work

PV cells are made from semi-conductor materials, such as polycrystalline silicon or thin film, that convert the sun's light into DC electricity. PV cells are connected in series to create a PV module and increase voltage.

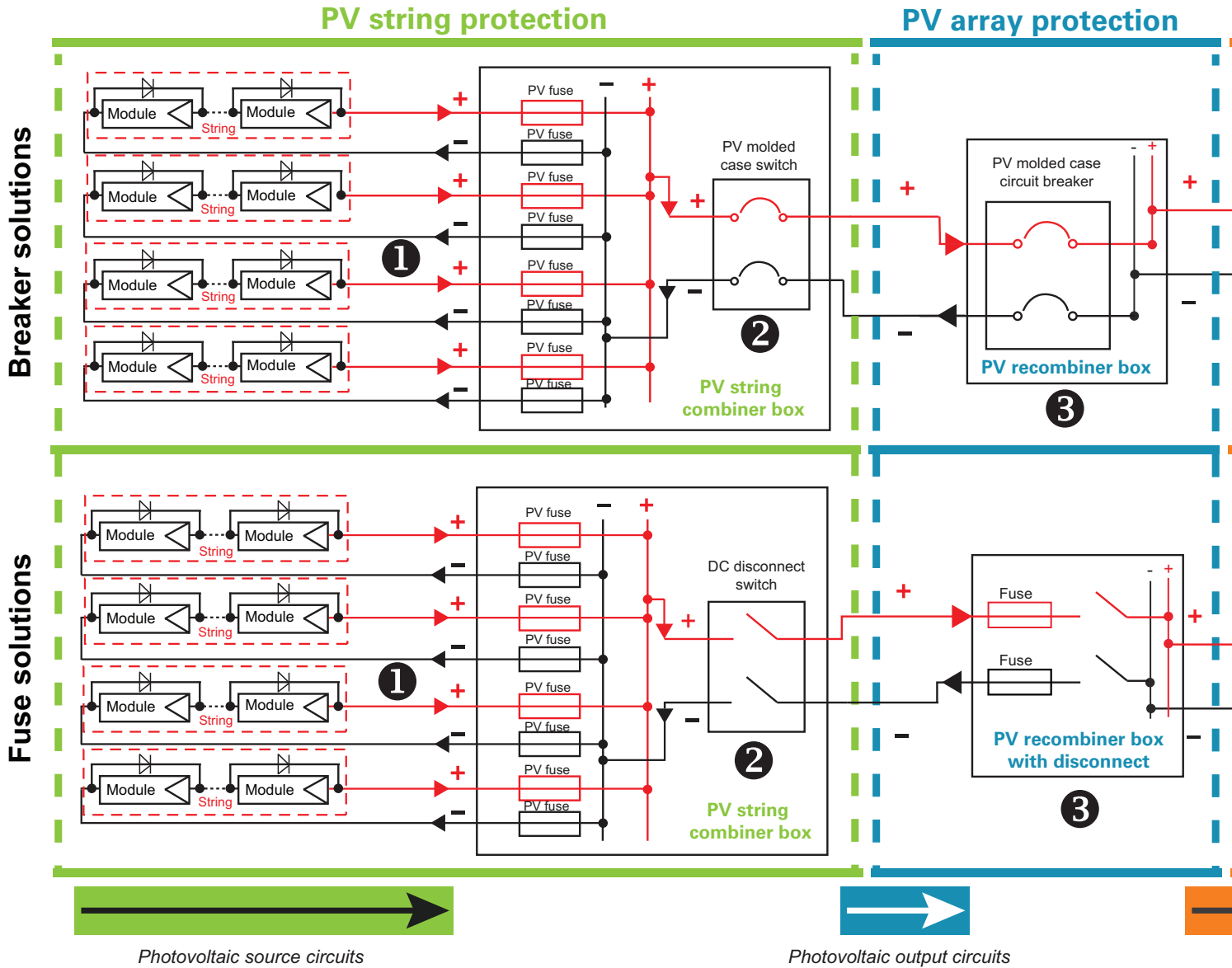

Figure 1: PV powered distribution network with NEC® defined circuits designated by arrows.



HPV and HEB in-line holders

1



10x38, 14x51, 14x65 PV fuses

1 2



CHPV PV fuse holders

2



PVS-R RK5 fuses

3 4



PV surge protective devices

2 3 4



PV molded case circuit breakers/switches

2 3 4

Protecting PV systems

PV Modules are then connected in series to create a PV string and further increase voltage.

PV Strings are next connected in parallel (often by a combiner box) to increase amperage.

The resulting DC power is sent to an inverter to be converted from DC to AC and then supplied to the electric grid and consumed.

Inverter protection

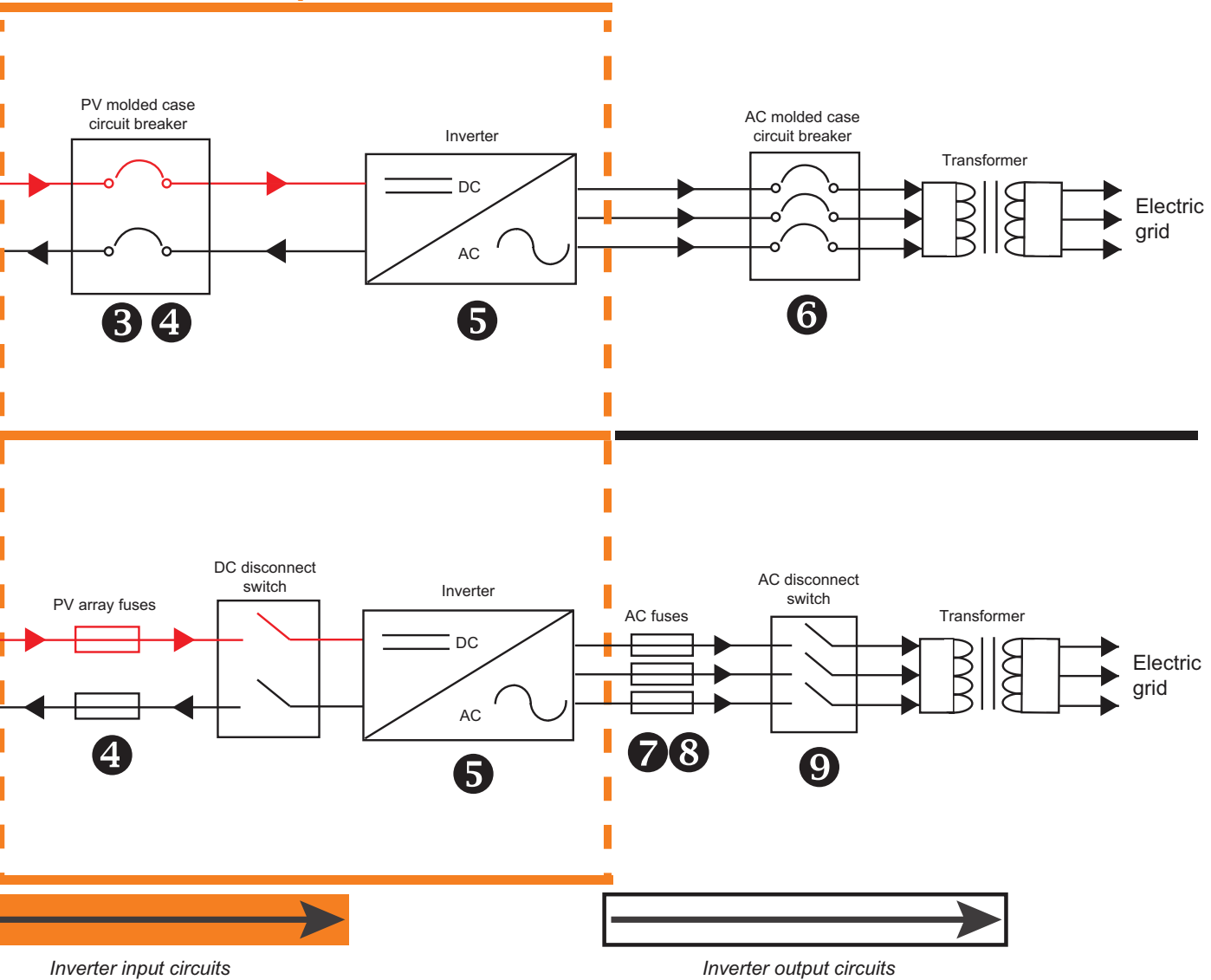

NH/XL PV fuses and blocks

3 4



High speed fuses

5



AC molded case circuit breakers

6



Low voltage UL power fuses

7



Low voltage IEC power fuses

8



AC disconnect switches

9

PV system standards

Unlike typical grid connected AC systems, the available short-circuit current within PV systems is limited, and the overcurrent protective devices (OCPDs) need to operate effectively on low levels of fault current. For this reason, Eaton has conducted extensive research and development of PV fuses and circuit breakers that are specifically designed and tested to protect PV systems with high DC voltages and low fault currents.

The International Electrotechnical Commissions (IEC) and Underwriters Laboratories (UL) recognize that the protection of PV systems is different than conventional electrical installations. This is reflected in IEC 60269-6 (gPV) and UL 248-19 for fuses and UL 489B for breakers that define specific characteristics an OCPD should meet for protecting PV systems. The range of Eaton OCPDs for PV string and PV array protection have been specifically designed to meet these standards.

PV fuses

- Fully tested to the requirements of IEC 60269-6 and exceed the requirements of operating at $1.45 \times I_n$ (1.45 times the nominal current). They also meet the requirements of UL 248-19* that are very similar to the IEC standards, except they operate at $1.35 \times I_n$ (1.35 times the nominal current).
- The current ratings assigned to PV fuses are defined by the performance requirements of IEC 60269-6 and UL 248-19 in order to protect PV modules during overcurrent situations. These IEC and UL ratings do not reflect a continuous service rating. The assigned service rating should be reduced at increased ambient temperatures.
- To ensure longevity of PV fuses, they should not be subjected to a continuous current of more than 80% of the assigned IEC and UL ratings.

PV Molded Case Circuit Breakers (MCCBs) and Molded Case Switches (MCS)

- Fully tested, met and exceeded to the requirements of UL 489B: operating at $1.35 \times I_n$ (1.35 times the nominal current) within 1 or 2 hours depending on amp rating (50A or less or over 50A respectively) and calibrated at 50°C ambient temperature.
- The current ratings assigned to PV circuit breakers are defined by the performance requirements of UL 489B in order to protect PV modules during overcurrent situations. MCCBs and MCS' are listed for a continuous load application. The assigned service rating should be reduced at increased ambient temperatures above 50°C.
- PV circuit breakers come in two application ratings: 80% and 100%. To ensure longevity of PV circuit breakers, each rating should be properly applied: a continuous current of 80% or 100% of the assigned UL ratings.

* UL 248-19 superseded UL 2579 in November 2015.

PV array construction

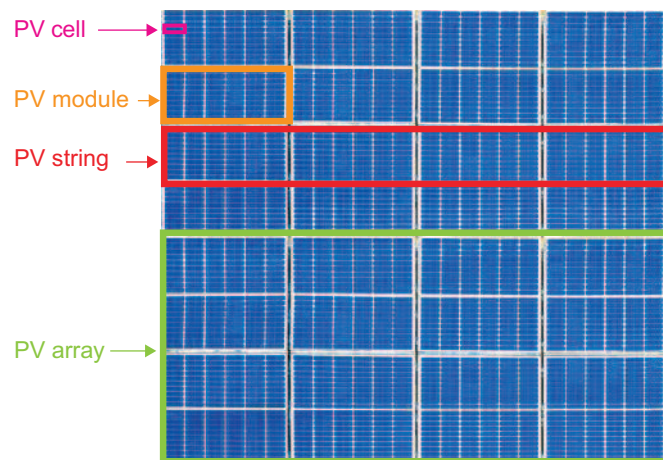

Figure 2: PV system construction

- **PV cells** are combined to create a **PV module**
- **PV modules** are connected in series to create a **PV string**
- **PV strings** are connected in parallel to create a **PV array**

The total voltage of a PV module or PV array is determined by the number of individual cells connected in series with each size usually between 4" and 6" square. An individual PV module is made up of a series PV cells.

PV source circuits

The commonly used PV modules are made with 4", 5" and 6" polycrystalline silicon, or thin film cells.

The Maximum-Power-Point (MPP) of the PV modules of equal PV cell dimensions can vary as much as 35% between manufacturers. When selecting the appropriate PV fuses, the specified Short-Circuit Current (I_{sc}) and reverse current characteristics specified by the manufacturer should be used.

The PV module manufacturer's specifications should be consulted to confirm the PV module's output amperage and voltage under the expected range of conditions for the proposed installation. These conditions are influenced by the ambient temperature, the sun's incident angle and the amount of solar energy reaching the PV module. These are usually mentioned as coefficients on the manufacturer's specifications.

Manufacturers also suggest the maximum series fuse rating or a reverse current rating. Both of these are based on PV modules withstanding 1.35 times this rating for two hours.

PV source circuit protection overview

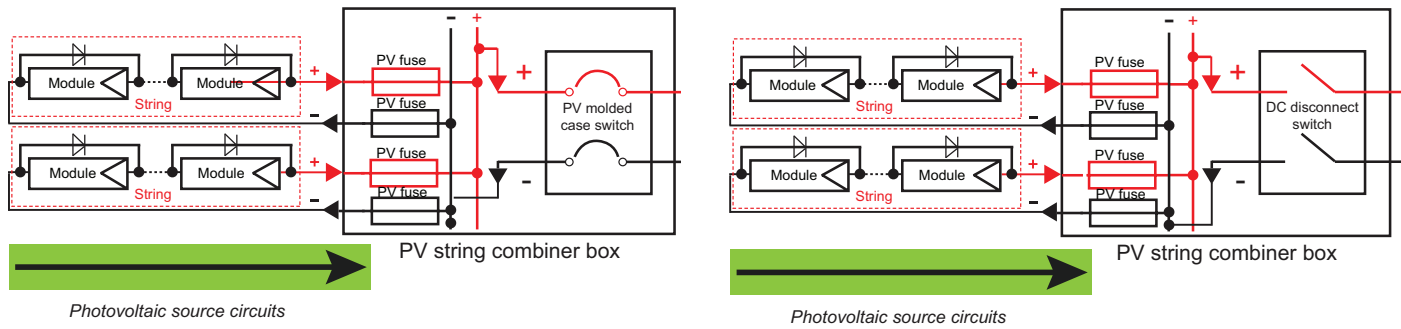

DC Molded case switch solution helps meet NEC® 690.12 requirement for rapid shutdown.

Figure 3: PV source circuit protection overview with NEC® defined circuits designated by arrows.

Depending on the desired PV system capacity, there may be several PV strings connected in parallel to achieve higher amperage and subsequently more power.

Systems that have less than three PV strings will not generate enough fault current (short-circuit) to damage the PV modules, conductors or downstream equipment, and do not present a safety hazard, provided the conductor is correctly sized based on local codes and installation requirements.

When three or more PV strings are connected in parallel, a PV fuse on each PV string will protect the PV modules and conductors from overcurrent faults and help minimize any safety hazards. The PV fuse will also isolate the faulted PV string so the balance of the PV system can continue to generate electricity.

The difference between DC molded case switch and the DC disconnect switch solutions in Figure 3 is a different type of disconnect means. PV fuses are used for overcurrent protection in either case. MCS in this PV string combiner box provides the dual function of a disconnect means with remote OFF operation suitable for meeting the NEC® 2014 690.12 requirement for PV rapid shutdown.

NEC® 2014 Article 690.12 Rapid Shutdown

With NEC® 2014 Article 690.12 there is a requirement for Rapid shutdown of PV systems and it reads as follows:

“690.12 Rapid Shutdown of PV Systems on Buildings

PV system circuit installed on or in buildings shall include a rapid shutdown function that controls specific conductors in accordance with 690.12(1) through (5) as follows:

- (1) Requirement of controlled conductors shall apply only to PV system conductors of more than 1.5 m (5 ft) in length inside a building, or more than 3 m (10 ft) from a PV array.

- (2) Controlled conductors shall be limited to not more than 30 volts and 240 volt-amperes within 10 seconds of rapid shutdown initiation.
- (3) Voltage and power shall be measured between any two conductors and between any conductor and ground.
- (4) The rapid shutdown initiation methods shall be labeled in accordance with 690.56(B).
- (5) Equipment that performs the rapid shutdown shall be listed and identified.”

First responders must contend with elements of a PV system that remain energized after the service disconnect is opened. This rapid shutdown requirement provides a zone outside of which the potential for shock has been mitigated. Conductors more than 5 feet inside a building or more than 10 feet from an array will be limited to a maximum of 30 V and 240VA within 10 seconds of activation of shutdown. Ten seconds allows time for any dc capacitor banks to discharge. Methods and designs for achieving proper rapid shutdown are not addressed (sic) by the NEC® but instead are addressed in the product standards for this type of equipment.

It should be remembered that PV module output changes with the operating temperature and the amount of sun light it is exposed to. The amount of exposure is dependent on irradiance level, angle of incidence and the shading effect from trees, buildings and clouds. In operation, PV fuses and circuit breakers, as thermal devices, are influenced by ambient temperature. The PV OCPD’s ampacity should be derated according to the manufacturer’s published curves and NEC® 690 requirements.

Component standards and ratings

It is vital to understand component, terminal and conductor temperature ratings and deratings as they relate to PV installations.

Component ratings

Per UL 489B, PV circuit breakers are rated to standard test conditions in open air at 50°C.

In actual applications, ambient temperatures in enclosures can exceed 50°C.

When high ambient temperatures are encountered appropriate component derating must be taken into account in the specifying process.

See individual product technical detail sheets for specific information on derating and derating factors to use in determining the correct rating for the application.

Terminal ratings

The PV circuit breakers and molded case switch terminals listed in this document and catalog No. CA08100005E are rated for 75°C conductors. Fuse holders, blocks and disconnects may be rated for 75°C or less, depending on the type of terminal. Even though a 90°C conductor may be used, it must be applied at an ampacity as if it were a lower-rated conductor to match the component's terminal temperature rating at 75°C per NEC® 110.14(C)(1)(a)(2).

Conductor ratings and sizing

Like circuit breakers and fuses, conductors are also rated to standard test conditions, although this is done for most conductors in open air at 30°C.

Per NEC® Table 310.15(B)(2)(a) conductors need to be derated to determine a conductor size that will safely carry the anticipated current generated by the PV system.

For more information on conductor sizing, see the Bussmann series publication No. 3002 *Selecting Protective Devices* (SPD) electrical protection handbook.

Selecting fuses for PV source circuits

While a full study of all the parameters is recommended, the following factors should be used when selecting a PV fuse to cover most installation variations:

- 1.56 for amps
- 1.20 for voltage

PV module specifications include:

I_{SC} = Short-circuit current of one module at Standard Test Conditions (STC)

V_{OC} = Open circuit voltage of one PV module at STC

Initial conditions for specifying PV fuses:

N_S = Number of PV modules in series per PV string

N_P = Number of PV strings in parallel per PV sub-array

Calculations to verify volts and amps:

- Fuse voltage rating $\geq 1.20 \times V_{OC} \times N_S$
- Fuse amp rating $\geq 1.56 \times I_{SC}$
- PV fuse amp rating $\leq I_Z^*$

Eaton recommends using Bussmann series PV fuses in both the positive and negative conductors, each with adequate voltage rating (as above).

Additional considerations:

- Voltage rating — per NEC® Table 690.7, if the system is required to operate below -40°C (-40°F), replace the 1.20 factor with 1.25.
- Amp rating — additional derating may be required when the fuse is installed in a high ambient temperature environment. See individual fuse data sheets for derating curves.
- Fuse protection is required in any PV system that is connected to a battery.

Understanding total PV source circuit short-circuit current

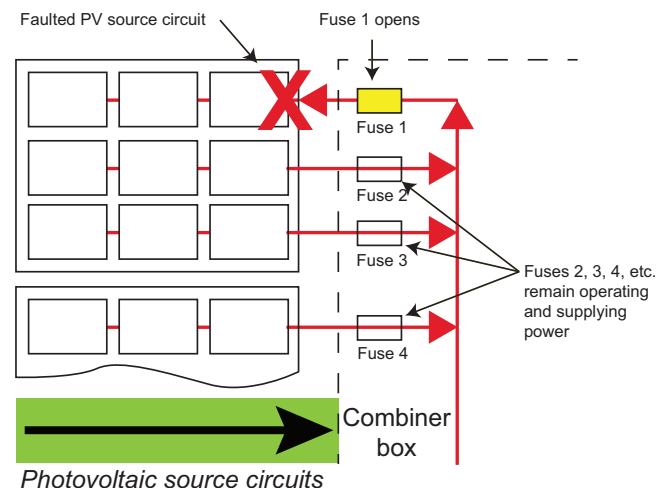

Figure 4: Faulted PV source circuit.

The total short-circuit current in Figure 4 that will flow through Fuse 1 is the number of parallel source circuits (N_P) minus the faulted circuit that is no longer supplying power, multiplied by the total fault current for each PV source circuit (I_{SC}) plus a 1.25 factor per the NEC®, or:

$$(N_P - 1) \times 1.25 \times I_{SC} = \text{Total short-circuit current.}$$

* I_Z Current capacity of conductors properly sized for the PV system.

Example — Selecting fuses for PV source circuits

Manufacturer's module specifications include:

- I_{SC} = 8.99A short-circuit current of one module at Standard Test Conditions (STC)
- V_{OC} = 45.6V open circuit voltage of one PV module at STC
- PV cell type: polycrystalline silicon
- PV cell size: 125mm² (5")
- PV cells and connection — 72 cells in series

PV installation set-up:

- N_s = 18 PV modules in series per PV string
- N_p = 28 PV strings in parallel per PV sub-array
 - PV module max ambient: 60°C (140°F)
 - PV module min ambient: -25°C (-13°F)

Calculation:

Note: when calculating for high ambient temperature applications, include the appropriate derating factors.

- Conductor size formula $\geq 1.56 \times I_{SC}$
 $= 1.56 \times 8.99A$
 $= 14.02A$
- Conductor size: 14AWG* $= 25A^{**}$
 14AWG at 60°C $= 25A \times 0.71$
 $I_z = 17.75A$
- Array max I_{SC_array} $= (N_p - 1) \times 1.25 \times I_{SC}$
 $= (28 - 1) \times 1.25 \times 8.99A$
 $= 303.4A$
- Array max $I_{SC_array} >$ conductor rating; PV source circuit fuses are needed

Once it's determined that the maximum short-circuit current exceeds the conductor's continuous current rating, selecting the correct PV source circuit fuse is as follows:

- Fuse amp rating $\geq 1.56 \times I_{SC}$
 $= 1.56 \times 8.99A$
 $= 14.02A$ min
- Maximum system voltage $= 1.20 \times V_{OC} \times N_s$
 $= 1.20 \times 45.6V \times 18$
 $= 985V$

The required PV fuse needs to be 1000Vdc and 15A.

Note: fuse amp rating must be equal to or less than the I_z ampacity of the selected conductor.

Bussmann part numbers are:

- PV-15A10F (ferrule - page 19)
- PV-15A10T (bolt fixing - page 19)
- PV-15A10-1P (PCB fixing - page 19)
- PV-15A10F-CT (in-line crimp terminal - page 19)
- HPV-DV-15A (in-line fuse assembly - page 25)

The selected PV fuses will protect the conductor and the PV source circuit against reverse current faults.

* 75°C component terminal rating for 14AWG = 20A.

** Conductor rating per NEC® Table 310.15(B)(2)(a) for 90°C copper wire.

PV output circuit and inverter input circuit protection overview

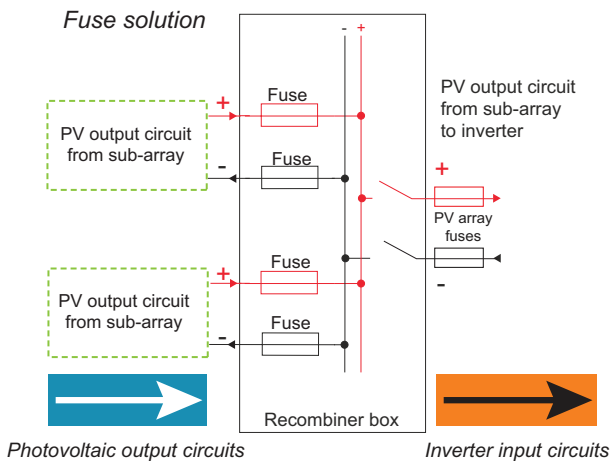
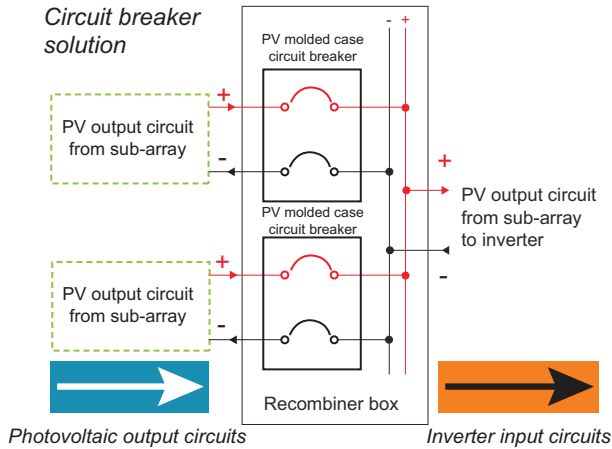

Figure 5: PV output circuit protection (array protection) with NEC® defined circuits designated by arrows.

Depending on the PV system capacity, there may be several PV output circuits (each output circuit consisting of multiple PV source circuits) connected in parallel to achieve higher ampacity and subsequently more power.

A PV Overcurrent Protective Device (OCPD) on each PV output circuit will protect the conductors from fault currents and help minimize any safety hazards. It will also isolate the faulted PV output circuit so that the rest of the PV system will continue generating electricity.

A PV OCPD positioned in the conductor that carries the combined power output from a number of PV output circuits should be protected by a PV output circuit OCPD. If a number of PV output circuits are subsequently combined prior to the inverter, then another PV OCPD should be incorporated. This would be termed the PV inverter input circuit as shown above.

It should be remembered that the PV module performance varies with temperature and irradiance level. In operation, PV OCPDs are influenced by ambient temperature and derating should be factored in when being specified.

Selecting fuses for PV output circuits

While a full study of all the parameters is recommended, the following factors should be used when selecting the PV fuse to cover most installation variations:

- 1.56 for amps
- 1.20 for voltage

Initial conditions for specifying PV fuses:

- N_s = Number of PV modules in series per PV string
- N_p = Number of PV strings in parallel per PV sub-array
- N_{sub} = Number of PV sub-arrays in parallel per PV array
- I_{sc} = Short-circuit current of one PV module at Standard Test Conditions (STC)
- V_{oc} = Open circuit voltage of one PV module at STC

Calculations to verify volts, amps and conductor size:

- Fuse voltage rating $\geq 1.20 \times V_{oc} \times N_s$
- PV output circuit amp rating $\geq 1.56 \times I_{sc} \times N_p$
- Inverter input circuit amp rating $\geq 1.56 \times I_{sc} \times N_p \times N_{sub}$
- PV fuse amp rating $\leq I_z^*$

Bussmann recommends using PV fuses on positive and negative conductors, each with adequate voltage rating. Selective coordination with PV string fuses may not be achieved under some fault conditions.

Additional considerations:

- Voltage rating — per NEC® Table 690.7, if the system is required to operate below -40°C (-40°F), replace the 1.20 factor with 1.25.
- Amp rating — additional derating may be required when the fuse is installed in a high ambient temperature environment. See individual fuse data sheets for derating curves.
- Fuse protection is required in any PV system that is connected to a battery.

* I_z Current capacity of conductors properly sized for the PV system.

Example — selecting fuses for PV output circuits

Manufacturer's module specifications include:

I_{sc} = 8.99A short-circuit current of one PV module at Standard Test Conditions (STC)

V_{oc} = 45.6V open circuit voltage of one PV module at STC

PV installation set-up:

N_s = 18 PV modules in series per PV string

N_p = 8 PV strings in parallel per PV sub-array

N_{sub} = 3 PV sub-arrays in parallel per PV array

- PV module max ambient: 60°C (140°F)
- PV module min ambient: -25°C (-13°F)

Calculation:

Note: When calculating for high ambient temperature applications, include the appropriate derating factors.

- Conductor size formula $\geq 1.56 \times I_{sc} \times N_p$
 $= 1.56 \times 8.99A \times 8$
 $= 112A$
- Conductor size: 1/0* $= 170A^{**}$
 1/0 at 60°C $= 170A \times 0.71$
 I_z $= 120.7A$
- PV sub-array max I_{sc_sub} $= (N_{sub} - 1) \times N_p \times 1.25 \times I_{sc}$
 $= (3-1) \times 8 \times 1.25 \times 8.99A$
 $= 180A$
- PV sub-array maximum fault current $I_{sc_sub} >$ conductor rating; PV fuses are required
- PV fuse amp rating $\geq 1.56 \times I_{sc} \times N_p$
 $= 1.56 \times 8.99A \times 8$
 $= 112A$ min
- PV fuse voltage rating $\geq 1.20 \times V_{oc} \times N_s$
 $= 1.20 \times 45.6V \times 18$
 $= 985V$

Therefore, select a standard 1000Vdc PV fuse rating of 125A.

Note: fuse amp rating must be equal to or less than the I_z ampacity of the selected conductor.

Bussmann series part numbers are:

- PV-125ANH1 (NH1 PV fuse, page 21)
- PV-125A-01XL (XL01 PV blade fixing fuse, page 22)
- PV-125A-01XL-B (XL01 PV bolt fixing fuse, page 22)

Example — inverter input circuit protection

If N_{sub} PV sub-arrays are to be further connected via a recombiner to the inverter input circuit, the PV array PV fuse rating should be at least:

$$\begin{aligned} &\geq 1.56 \times I_{sc} \times N_p \times N_{sub} \\ &= 1.56 \times 8.99A \times 8 \times 3 \\ &= 336A \text{ min} \end{aligned}$$

Therefore, a 1000Vdc 350A PV fuse should be selected.

Bussmann series part numbers are:

- PV-350ANH3 (NH3 PV fuse, page 21)
- PV-350A-2XL (XL2 PV blade fixing fuse, page 22)
- PV-350A-2XL-B (XL2 PV bolt fixing fuse, page 22)

* 75°C component terminal rating for 1/0 = 150A.

** Conductor rating per NEC® Table 310.15(B)(2)(a) for 90°C copper wire.

Selecting circuit breakers for PV output circuits

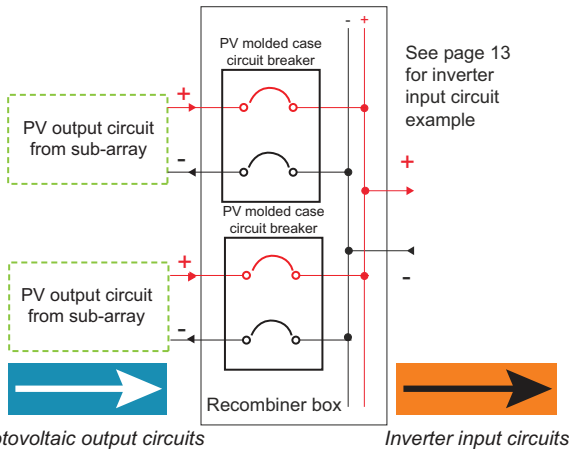

Figure 6: PV output circuit protection with NEC® defined circuits designated by arrows.

PV circuit breakers are available in 600 and 1000Vdc models with either 80% or 100% ratings. Understanding the difference between 80% and 100% rated circuit breakers is important. The major benefit of a 100% rated circuit breaker is the ability to apply 100% of its nameplate ampacity, allowing an opportunity for reduction in circuit breaker ampacity, frame size, conductor size and potentially the enclosure size.

80% rated circuit breaker

Combine the total ampacity of the PV source circuits using a 1.56 derating factor (module $I_{sc} \times 1.25 \times 1.25 \times$ number of strings in parallel).

100% rated circuit breaker

Combine the total ampacity of the PV source circuits using a 1.25 derating factor (module $I_{sc} \times 1.25 \times$ number of strings in parallel).

Initial conditions for specifying PV circuit breakers:

- N_s = Number of PV modules in series per PV string
- N_p = Number of PV strings in parallel per PV sub-array
- N_{sub} = Number of PV sub-arrays in parallel per PV array
- I_{sc} = Short-circuit current of one PV module at Standard Test Conditions (STC)
- V_{oc} = Open circuit voltage of one PV module at STC

Calculations to verify volts, amps and conductor size

80% rated breakers:

- Circuit breaker voltage rating $\geq 1.20 \times V_{oc} \times N_s$
- PV Output circuit amp rating $\geq 1.56 \times I_{sc} \times N_p$
- Inverter input circuit amp rating $\geq 1.56 \times I_{sc} \times N_p \times N_{sub}$
- PV Circuit breaker amp rating $\leq I_z^*$

100% rated breakers:

- Circuit breaker voltage rating $\geq 1.20 \times V_{oc} \times N_s$
- PV output circuit amp rating $\geq 1.25 \times I_{sc} \times N_p$
- Inverter input circuit amp rating $\geq 1.25 \times I_{sc} \times N_p \times N_{sub}$
- PV circuit breaker amp rating $\leq I_z^*$

Note: selective coordination with PV circuit breakers on the PV source circuits may not be achieved under some fault conditions.

Additional considerations:

- Voltage rating — per NEC® Table 690.7, if the system is required to operate below -40°C (-40°F), replace the 1.20 factor with 1.25.
- Amp rating — additional derating may be required when the circuit breaker is installed in a high ambient temperature environment. See circuit breaker technical document for details.
- DC rated circuit breaker protection is required in any PV system that is connected to a battery.

Eaton Design Suggestion

PV Molded case switches ease compliance with NEC® Rapid Shutdown requirement.

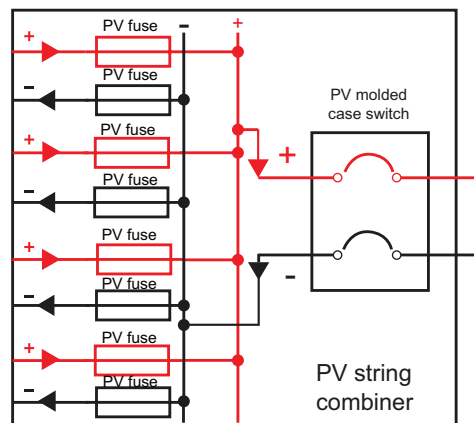

The PV molded case switch shown in this PV source circuit combiner provides a dual function of a disconnect means with remote OFF operation suitable for the NEC® 2014 690.12 PV rapid shutdown requirement.

* I_z Current capacity of conductors properly sized for the PV system.

Example — selecting circuit breakers for PV output circuits

Manufacturer's module specifications:

I_{SC} = 8.99A short-circuit current of one PV module at Standard Test Conditions (STC)

V_{OC} = 45.6V open circuit voltage of one PV module at STC

PV installation set-up:

N_S = 18 PV strings in series per PV array

N_P = 8 PV output circuits in parallel per PV output circuit combiner

N_{Sub} = 3 PV sub-arrays in parallel per PV array

- Module max ambient: 60°C (140°F)
- Module min ambient: -25°C (-13°F)

Calculations

Note: when calculating for high ambient temperature applications, include the appropriate derating factors.

80% rated molded case circuit breaker (1000Vdc) 50°C:

- Conductor size formula $\geq 1.56 \times I_{SC} \times N_P$
= $1.56 \times 8.99A \times 8$
= 112A
- Conductor size: 1/0* = 170A**
1/0 at 60°C = $170A \times 0.71$
 I_Z = 120.7A†
- PV sub-array max I_{SC_sub} = $(N_{Sub} - 1) \times N_P \times 1.25 \times I_{SC}$
= $(3-1) \times 8 \times 1.25 \times 8.99A$
= 180A
- PV sub-array maximum fault current $I_{SC - sub}$ > conductor withstand; PV circuit breakers are required
- PV circuit breaker amp rating $\geq 1.56 \times I_{SC} \times N_P$
= $1.56 \times 8.99A \times 8$
= 112A min
- PV circuit breaker voltage rating $\geq 1.20 \times V_{OC} \times N_S$
= $1.20 \times 45.6V \times 18$
= 985V

Therefore, a 1000Vdc 125 amp† PV circuit breaker should be selected such as KDPV4125W. See page 27.

Note: circuit breaker amp rating must be equal to or less than the I_Z ampacity of the selected conductor unless a standard rating in unavailable†.

100% rated molded case circuit breaker (1000Vdc) 50°C:

- Conductor size formula $\geq 1.25 \times I_{SC} \times N_P$
= $1.25 \times 8.99A \times 8$
= 90A
- Conductor size: 2AWG* = 130A**
2AWG at 60°C = $130A \times 0.71$
 I_Z = 92A
- PV sub-array max I_{SC_sub} = $(N_{Sub} - 1) \times N_P \times 1.25 \times I_{SC}$
= $(3-1) \times 8 \times 1.25 \times 8.99A$
= 180A
- PV sub-array maximum fault current $I_{SC - sub}$ > conductor withstand; PV circuit breakers are required
- PV circuit breaker amp rating $\geq 1.25 \times I_{SC} \times N_P$
= $1.25 \times 8.99A \times 8$
= 90A min
- PV circuit breaker voltage rating $\geq 1.20 \times V_{OC} \times N_S$
= $1.20 \times 45.6V \times 18$
= 985V

Therefore, a 1000Vdc 90A PV circuit breaker should be selected such as CFDPV4090W. See page 27.

Note: circuit breaker amp rating must be equal to or less than the I_Z ampacity of the selected conductor unless a standard rating in unavailable†.

Example — inverter input circuit protection

If N_{Sub} PV sub-arrays are to be further connected via a recombiner to the inverter input circuit, the PV array PV circuit breaker rating should be at least:

80% rated molded case circuit breaker (1000Vdc) 50°C:

$$\begin{aligned} &\geq 1.56 \times I_{SC} \times N_P \times N_{Sub} \\ &= 1.56 \times 8.99A \times 8 \times 3 \\ &= 337A \text{ min} \end{aligned}$$

Therefore, a 1000Vdc 350A PV circuit breaker should be selected such as KDPV4350W, LGPV4350W or MDLPV3350W. See page 27.

100% rated molded case circuit breaker (1000Vdc) 50°C:

$$\begin{aligned} &\geq 1.25 \times I_{SC} \times N_P \times N_{Sub} \\ &= 1.25 \times 8.99A \times 8 \times 3 \\ &= 270A \text{ min} \end{aligned}$$

Therefore, a 1000Vdc 300A PV circuit breaker should be selected such as CKDPV4300W, CLGPV4300W or CMDLPV3300W. See page 27.

Note: conductor size examples above are for comparison only.

* 75°C component terminal rating for: 1/0 = 150A
2AWG = 115A

** Conductor rating per NEC® Table 310.15(B)(2)(a) for 90°C copper wire.
† Per NEC® 240.4(B), if the conductor ampacity does not correspond to a standard circuit breaker amp rating, it is permitted to select the next higher circuit breaker amp rating.

Bussmann series PV fuses

Body type	Body size	Fuse type	Catalog symbol	Rated current (amps)	Rated voltage (Vdc)	Agency information				Data sheet number	Block/holder series
						gPV*	UL	CCC*	CSA		
In-line	10x38mm	In-line ferrule	PV-(amp)A10F-CT	1, 2, 3, 3.5, 4, 5, 6, 8, 10, 12, 15, 20A	1000	—	•	—	•†	10150	N/A
	10x38mm	In-line ferrule	HPV-DV-(amp)A	1, 2, 3, 3.5, 4, 5, 6, 8, 10, 12, 15, 20A	1000	—	•	—	•†	2157	N/A
Cylindrical	10x38mm	Ferrule	PVM-(amp)	4, 5, 6, 7, 8, 9, 10, 12, 15, 20, 25, 30A	600	—	•	—	•	2153	BMM HEB CHM
	10x38mm	Ferrule	PV-(amp)A10F	1, 2, 3, 3.5, 4, 5, 6, 8, 10, 12, 15, 20A	1000	•	•	•**	•	10121	CHPV N/A N/A N/A
		Bolt fixing	PV-(amp)A10-T								
		PCB (one pin)	PV-(amp)A10-1P								
		PCB (two pins)	PV-(amp)A10-2P								
	14x51mm	Ferrule	PV-(amp)A14F	15, 20, 25, 32A	1000	•	•	•†	•†	720132	CH14B-PV
14x65mm	Ferrule	PV-(amp)A14LF	2.25, 2.5, 3.0, 3.5, 4.0, 15, 20, 25, 32A	1300/ 1500	•	•	•†	•†	720139	N/A	
	W/ tags	PV-(amp)A14L-T									
UL RK5	Ferrule	Class RK5	PVS-R-(amp)	20, 25, 30, 35, 40, 50, 60A 70, 80, 90, 100, 110, 125 150, 175, 200, 225, 250 300, 350, 400A	600	—	•	—	•	4203	RM60
	Blade										
Square body	NH1	Bladed	PV-(amp)ANH1	32, 40, 50, 63, 80, 100 110, 125, 160, 175, 200A	1000	•	•	•†	•	720133	SD
		Bolted	PV-(amp)ANH1-B	63, 80, 100, 125, 160, 200A							
	NH2	Bladed	PV-(amp)ANH2	160, 200, 250A	1000	•	•	•†	•†		
		Bolted	PV-(amp)ANH2-B	160, 200, 250A							
	NH3	Bladed	PV-(amp)ANH3	300, 315, 350, 355, 400A	1000	•	•	•†	•†		
		Bolted	PV-(amp)ANH3-B	315, 355, 400A							
	01XL	Bladed	PV-(amp)A-01XL	63, 80, 100, 125, 160A	1000	•	•	—	•		
		Bolted	PV-(amp)A-01XL-B	125, 160A							
		Bladed	PV-(amp)A-01XL-15	50, 63, 80,	1500	•	•	—	•		
		Bolted	PV-(amp)A-01XL-B-15	100, 125, 160†A							
	1XL	Bladed	PV-(amp)A-1XL	200A	1000	•	•	—	•		
		Bolted	PV-(amp)A-1XL-B	100, 125, 160, 200A							
		Bladed	PV-(amp)A-1XL-15	100, 125, 160, 200A	1500	•	•	—	•		
		Bolted	PV-(amp)A-1XL-B-15	160, 200A							
	2XL	Bladed	PV-(amp)A-2XL	160, 200, 250, 315, 350, 355A	1000	•	•	—	•		
		Bolted	PV-(amp)A-2XL-B	125, 160, 200, 250A							
		Bladed	PV-(amp)A-2XL-15	125, 160, 200, 250A	1500	•	•	—	•		
		Bolted	PV-(amp)A-2XL-B-15	125, 160, 200, 250A							
3L	Bladed	PV-(amp)A-3L	350, 400, 500, 600, 630††A	1000	•	•	—	•			
	Bolted	PV-(amp)A-3L-B	250, 315, 355, 400A								
	Bladed	PV-(amp)A-3L-15	250, 315, 355, 400A	1500	•	•	—	•			
	Bolted	PV-(amp)A-3L-B-15	250, 315, 355, 400A								

* IEC 60269-6.

** 1 to 15A only.

† Pending.

†† 630A thermally rated to UL only.











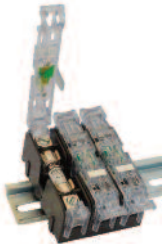

‡ 160A @ 1200Vdc.

Bussmann series PV fuse holders and blocks

Fuse size	Holder/block series	Part numbers	Poles	Rated voltage (Vdc)	Description	Data sheet number
10x38	CHPV	CHPV1U	1	1000	IP20 DIN-Rail mount finger-safe holder	3185†
		CHPV1IU	2		IP20 DIN-Rail mount finger-safe holder w/ open fuse indication	
14x51	CH14	CHPV2U		1	1000	IP20 DIN-Rail mount finger-safe holder
		CHPV2IU	IP20 DIN-Rail mount finger-safe holder w/ open fuse indication			
RK5	RM60	RM60100-1CR RM60200-1CR RM60400-1CR RM60600-1CR	1	600	70-100A single-pole fuse blocks with optional IP20 covers 110-200A single-pole fuse blocks with optional IP20 covers 225-400A single-pole fuse blocks with optional IP20 covers 450-600A single-pole fuse blocks with optional IP20 covers	3192†
NH1 NH2 NH3	SD_D-PV	SD1-D-PV SD2-D-PV SD3-D-PV	1	1000	IP20 finger-safe holder††	720149
01XL 1XL 2XL 3L	SB_XL-S	SB1XL-S SB1XL-S SB2XL-S SB3L-S	1	1500	XL fuse block	10066
In-line	HPV-	HPV-DV-_A	1	1000	Single-pole, in-line fuse holder and fuse (1 to 20A)	2157

† Literature reorder number.

†† Requires range of protection accessories.

System volts/fuses	Fuse holders	In-line fuse holders	Fuse blocks
600V <ul style="list-style-type: none"> • 10x38mm • RK5 	 <p>10x38mm PV fuses CHM Lit No. 3185</p>  <p>0-200A RK5 PVS-R fuse DC safety switch Lit No. 3156</p>	 <p>10x38mm PV fuses HEB DS No. 2127</p>	 <p>10x38mm/ midget PV fuses BMM DS No. 10241</p>  <p>RK5 0-60A PV fuses R600 DS No. 1111</p>  <p>RK5 70-400A PV fuses RM60 Lit No. 3192</p>
1000V <ul style="list-style-type: none"> • 10x38mm • 14x51mm • NH • XL • In-line 	 <p>10x38mm PV fuses CHPV Lit No. 3185</p>  <p>14x51 PV fuses CH14 DS No. 720148</p>	 <p>In-line PV fuse HPV-DC- A DS No. 2157</p>	 <p>NH PV fuses SD DS No. 720149</p>  <p>10x38mm PV fuses BPVM DS No. 10265</p>  <p>XL PV fuses SB DS No. 10066</p>
1500V <ul style="list-style-type: none"> • XL 			 <p>XL PV fuses SB DS No. 10066</p>

10x38mm Bussmann series PVM fuses — 600Vdc, 4-30A

RoHS



Description:

A range of UL 248-19 fast-acting 600Vdc midjet fuses specifically designed to protect solar power systems in extreme ambient temperature, high cycling and low level fault current conditions (reverse current, multi-array fault).

Dimensions:

- 10x38mm (1½" x 1½")

Ratings:

Volts — 600Vdc to UL 248-19

Amps — 4-30A

IR — 50kA DC (4-30A)

Watts loss (W) at rated current:

Amps	0.8 x I _n *	1.0 x I _n *
10A:	1.0W	1.9W
15A:	1.0W	1.7W
30A:	1.6W	2.9W

* I_n = Rated current.

Agency information:

- UL Listed 248-19, Guide JFGA, File E335324
- CSA Component Certified C22.2, Class 1422-30, File 53787.
- RoHS compliant

Catalog numbers (amp):

PVM-4	PVM-7	PVM-10	PVM-20
PVM-5	PVM-8	PVM-12	PVM-25
PVM-6	PVM-9	PVM-15	PVM-30

Features and benefits:

- Specifically designed to protect solar power systems in extreme ambient temperature per UL 248-19
- Capable of withstanding high cycling and low level fault current conditions

Typical applications:

- Combiner boxes
- PV Wire harnesses

Recommended fuse blocks and holders:

Symbol	Description	Doc No.
CHM	600V DIN-Rail fuse holder	Lit No. 3185
CHPV	1000V DIN-Rail fuse holder	Lit No. 3185
HEB	600V In-line fuse holder	DS No. 2127
BMM	600V 1-, 2- and 3-pole blocks	DS No. 10241
1A3400-__	PCB fuseclip	DS No. 2131

RK5 Bussmann series PVS-R fuses — 600Vdc, 20-400A



Description:

A range of UL 248-19 fast-acting 600Vdc Class RK5 fuses specifically designed to protect solar power systems in extreme ambient temperature, high cycling and low level fault current conditions (reverse current, multi-array fault).

Dimensions:

- Standard Class RK5 case sizes by amp rating.

Ratings:

Volts — 600Vac to UL 248-12
 600Vdc to UL 248-19
 Amps — 20-400A
 IR — 200kA RMS Sym. AC
 20kA DC (20-60A)
 10kA DC (70-400A)

Agency information:

- UL Std. 248-12, Class RK5, UL Listed, Guide JFGA, File E335324. Photovoltaic to UL 248-19.
- CSA Component Certified C22.2.

Catalog numbers (amp):

PVS-R-20	PVS-R-70	PVS-R-175
PVS-R-25	PVS-R-80	PVS-R-200
PVS-R-30	PVS-R-90	PVS-R-225
PVS-R-35	PVS-R-100	PVS-R-250
PVS-R-40	PVS-R-110	PVS-R-300
PVS-R-50	PVS-R-125	PVS-R-350
PVS-R-60	PVS-R-150	PVS-R-400

Features and benefits:

- Current limitation for non-inductive circuits provides Class RK5 current-limiting response to ground fault and short-circuit conditions
- Designed for the protection and isolation of PV systems

Typical applications:

- Inverters
- DC safety switches
- Recombiner boxes

Recommended fuse blocks:

Fuse amps	1-Pole	2-Pole	3-Pole
0-30	RM60030-1_	RM60030-2_	RM60030-3_
35-60	RM60060-1_	RM60060-2_	RM60060-3_
70-100	RM60100-1CR	RM60100-2CR	RM60100-3CR
110-200	RM60200-1CR	RM60200-2CR	RM60200-3CR
225-400	RM60400-1CR	RM60400-2CR	RM60400-3CR
450-600	RM60600-1CR	RM60600-2CR	RM60100-3CR

For additional information on the 0-60A RM600 600V fuse blocks, see data sheet No. 10241.

For additional information on the 70-600 amp RM 600V fuse blocks, see product brochure No. 3192.

Recommended DC safety switch:



**30-200A RK5
 DC safety switch
 Lit No. 3156**

10x38mm Bussmann series PV fuses — 1000Vdc, 1-20A



RoHS

Description:

A range 10x38mm, 1000Vdc PV fuses for the protection and isolation of photovoltaic strings. The fuses are specifically designed for use in PV systems with extreme ambient temperature, high cycling and low fault current conditions (reverse current, multi-array fault) string arrays. Available with four mounting styles for application flexibility.

Basic fuse size:

- 10x38mm

Catalog symbols:

- PV-(amp)A10F (cylindrical)
- PV-(amp)A10-T (bolt mounting)
- PV-(amp)A10-1P (single PCB tab)
- PV-(amp)A10-2P (dual PCB tab)
- PV-(amp)10F-CT (in-line, crimp terminals)

Catalog numbers (amp)/electrical characteristics:

Cylindrical ferrule	Bolt fixing	PCB fixing single pin	PCB fixing double pin	In-line with crimp terminal	Rated amps	Rated volts (Vdc)	Interrupting rating	I ² t (A ² s)		Watts loss	
								Pre-arcing	Total @ rated volts	0.8I _n	I _n
PV-1A10F	PV-1A10-T	PV-1A10-1P	PV-1A10-2P	PV-1A10F-CT	1	1000	50kA	0.15	0.4	0.8	1.5
PV-2A10F	PV-2A10-T	PV-2A10-1P	PV-2A10-2P	PV-2A10F-CT	2	1000	50kA	1.2	3.4	0.6	1.0
PV-3A10F	PV-3A10-T	PV-3A10-1P	PV-3A10-2P	PV-3A10F-CT	3	1000	50kA	4	11	0.8	1.3
PV-3-5A10F	PV-3-5A10-T	PV-3-5A10-1P	PV-3-5A10-2P	PV-3-5A10F-CT	3.5	1000	50kA	6.6	18	0.9	1.4
PV-4A10F	PV-4A10-T	PV-4A10-1P	PV-4A10-2P	PV-4A10F-CT	4	1000	50kA	9.5	26	1.0	1.5
PV-5A10F	PV-5A10-T	PV-5A10-1P	PV-5A10-2P	PV-5A10F-CT	5	1000	50kA	19	50	1.0	1.6
PV-6A10F	PV-6A10-T	PV-6A10-1P	PV-6A10-2P	PV-6A10F-CT	6	1000	50kA	30	90	1.1	1.8
PV-8A10F	PV-8A10-T	PV-8A10-1P	PV-8A10-2P	PV-8A10F-CT	8	1000	50kA	3	32	1.2	2.1
PV-10A10F	PV-10A10-T	PV-10A10-1P	PV-10A10-2P	PV-10A10F-CT	10	1000	50kA	7	70	1.2	2.3
PV-12A10F	PV-12A10-T	PV-12A10-1P	PV-12A10-2P	PV-12A10F-CT	12	1000	50kA	12	120	1.5	2.7
PV-15A10F	PV-15A10-T	PV-15A10-1P	PV-15A10-2P	PV-15A10F-CT	15	1000	50kA	22	220	1.7	2.9
PV-20A10F	PV-20A10-T	PV-20A10-1P	PV-20A10-2P	PV-20A10F-CT	20	1000	50kA	34	350	2.1	3.6

Time constant:

- 1-3ms

PV fuse coordination:

With thin film cells and 4", 5" and 6" crystalline silicon cells

Agency information:

- UL Listed to 248-19 *, Guide JFGA, File E335324
 - IEC 60269-6 (gPV)
 - CSA File 53787, Class 1422-30, 20A pending
 - CCC (1-20A) (25-30A pending)
 - RoHS compliant
- * Except crimp terminal version that is UL Recognized to UL 248-19, Guide JFGA2, File E335324.

Features and benefits:

- Meets UL and IEC photovoltaic standards for global acceptance
- Low watts loss performance for energy efficiency
- Low temperature rise for more precise sizing
- In-line crimp terminal version is easy to apply in wire harness construction

Typical applications:

- Combiner boxes
- Inverters
- PV wire harnesses

Recommended fuse holders and fuseclips:

Part number	Description	Data sheet No.
CHPV_	1- and 2-pole modular fuse holders with optional open fuse indication	Lit No. 3185
BPVM	1- and 2-pole modular fuse blocks	10265
1A3400-09	PCB fuseclip	2131
HPV-DV-_A	In-line fuse holder assembly	2157

Data sheet: 10121

14x51mm Bussmann series PV fuses – 1000/1100Vdc, 15-32A



Description:

A range of 14x51mm PV fuses specifically designed for protecting and isolating photovoltaic strings. These fuses are capable of interrupting low overcurrents associated with faulted PV systems (reverse current, multi-array fault).

Ratings:

- Volts – 1000Vdc (25 and 32A)
- 1100Vdc (15 and 20A)
- Amps – 15-32A
- IR – 10kA

Agency information:

- UL Listed, Guide JFGA, File E335324. Photovoltaic to UL 248-19
- IEC 60269-6 gPV
- CSA pending
- CCC pending

Catalog numbers/electrical characteristics:

Catalog number	Rated amps	Rated volts DC	I ² t (A ² s)		Watts loss	
			Pre-arcing	Total @ rated volts	0.8I _n	I _n
PV-15A14F	15	1100	14	265	2.1	4
PV-20A14F	20	1100	27	568	2.7	5
PV-25A14F	25	1000	65	943	2.7	5.1
PV-32A14F	32	1000	120	1740	3.3	6.2

Features and benefits:

- Specifically designed to provide fast-acting protection under low fault current conditions associated with PV systems
- High DC voltage rating
- Demonstrated performance in extreme temperature cycling conditions

Typical applications:

- Combiner boxes
- Inverters

Recommended fuse holder:

CH141B-PV DIN-Rail modular fuse holder

See data sheet No. 720148 for more information.

**Bussmann series NH fuses —
1000Vdc, NH1, 2, 3, 32-400A**



Description:

A range of NH size PV fuses specifically designed for protecting and isolating photovoltaic array combiners and disconnects. These fuses are capable of interrupting low overcurrents associated with faulted PV systems (reverse current, multi-array fault).

Ratings:

- Volts — 1000Vdc
- Amps — 32-400A
- IR — 50kA

Agency information:

- UL Listed, Guide JFGA, File E335324. PV to UL 248-19
- IEC 60269-6 gPV
- CSA Class 1422-30, File 53787 (32-160A)
- CCC pending

Blade version catalog numbers/characteristics:

Fuse size	Catalog number	Rated amps	I ² t (A ² s)		Watts loss	
			Pre-arcing	Total @ rated volts	0.8I _N	I _N
NH1	PV-32ANH1	32	80	720	4	8.5
	PV-40ANH1	40	185	1670	5	9
	PV-50ANH1	50	400	3600	6	11
	PV-63ANH1	63	470	4300	6	12
	PV-80ANH1	80	640	5760	8	15.5
	PV-100ANH1	100	1300	11,700	8	16.5
	PV-110ANH1	110	2100	18,900	9	18.5
	PV-125ANH1	125	2600	23,400	9	17.5
	PV-160ANH1	160	5200	46,800	14	27.5
	PV-175ANH1	175	8300	74,700	15	29
NH2	PV-200ANH1	200	10,200	82,000	13	25
	PV-160ANH2	160	4600	37,000	14	28
	PV-200ANH2	200	9500	76,000	16	32
NH3	PV-250ANH2	250	17,000	136,000	19	38
	PV-300ANH3	300	32,000	260,000	24	40
	PV-315ANH3	315	32,000	260,000	26	44
	PV-350ANH3	350	44,500	370,000	27	45
	PV-355ANH3	355	44,500	370,000	28	46
	PV-400ANH3	400	67,500	550,000	30	50

Features and benefits:

- Compact size saves panel space and extends design flexibility
- Low power loss for greater efficiency and lower operating temperature
- Global agency standards simplifies design considerations for worldwide markets
- Dual indication feature and optional microswitches make system monitoring easier

Typical applications:

- Recombiner boxes
- Inverters

Recommended fuse blocks:

Fuse size	Fuse block
NH1	SD1-D-PV
NH2	SD2-D-PV
NH3	SD3-D-PV

See data sheet No. 720149 for more information.

Optional microswitches:

Part number	Tab size/ mm (inch)	Connection	Volts	Amps
170H0236	250/6.3 (¼)	Quick connect	250	2
170H0238	110/2.8 (0.11)	Quick connect	250	2
BVL50	187/4.8 (¾)	Quick connect	250	6

Bolt-on version catalog numbers/characteristics:

Fuse size	Catalog number	Rated amps	I ² t (A ² s)		Watts loss	
			Pre-arcing	Total @ rated volts	0.8I _N	I _N
NH1	PV-63ANH1-B	63	470	4300	6	12
	PV-80ANH1-B	80	640	5760	8	15
	PV-100ANH1-B	100	1300	11,700	8	16
	PV-125ANH1-B	125	2600	23,400	9	17
	PV-160ANH1-B	160	5200	46,800	14	27
	PV-200ANH1-B	200	10,200	82,000	13	25
NH2	PV-250ANH2-B	160	4600	37,000	14	28
	PV-250ANH2-B	200	9500	76,000	16	32
	PV-250ANH2-B	250	17,000	136,000	19	38
NH3	PV-315ANH3-B	315	32,000	260,000	26	44
	PV-355ANH3-B	355	38,000	310,000	29	48
	PV-400ANH3-B	400	61,000	490,000	32	50

Data sheet: 720133

**Bussmann series XL Fuses –
1000Vdc, XL01, 1, 2, 3, 63-630A**



Description:

A range of XL size PV fuses specifically designed for protecting and isolating photovoltaic array combiners and disconnects. These fuses are capable of interrupting low overcurrents associated with faulted PV systems (reverse current, multi-array fault). Available with optional microswitches for use in monitoring systems.

Catalog symbols:

Blade – PV-(amp)A(size)XL
Bolt-in – PV-(amp)A(size)XL-B

Agency information:

- UL 248-19 , Guide JFGA, File E335324
- IEC 60269-6
- CSA Class 1422-30, File 53787
- RoHS compliant

Features and benefits:

- Specifically designed to provide fast-acting protection under low fault current conditions associated with PV systems
- High DC voltage rating
- Variety of mounting options for flexibility
- Demonstrated performance in extreme temperature cycling conditions

Typical applications:

- Recombiner boxes
- Inverters

Recommended fuse holders:

Fuse size	Part number	Description
01XL	SB1XL-S	1-pole block
1XL	SB1XL-S	1-pole block
2XL	SB2XL-S	1-pole block
3L	SB3L-S	1-pole block

See data sheet No. 10066 for more information.

Optional microswitches:

Blade – 170H0235 or 170H0237 for size 01XL
 – 170H0236 or 170H0238 for sizes 1XL, 2XL and 3L
 Bolt-in – 170H0069 for all sizes

Catalog numbers (amp)/electrical characteristics:

Fuse size	Bladed version	Bolt-in version	Rated amps	Rated volts (Vdc)	Interrupting rating	I ² t (A ² s)		Watts loss	
						Pre-arcing	Total @ rated volts	0.8In	In
01	PV-63A-01XL	PV-63A-01XL-B	63	1000	50kA	260	1900	13	24
	PV-80A-01XL	PV-80A-01XL-B	80	1000	50kA	490	3600	17	29
	PV-100A-01XL	PV-100A-01XL-B	100	1000	50kA	870	6300	18	32
	PV-125A-01XL	PV-125A-01XL-B	125	1000	50kA	1930	13,900	20	40
	PV-160A-01XL	PV-160A-01XL-B	160	1000	50kA	3900	28,100	22	44
1	PV-200A-1XL	PV-200A-1XL-B	200	1000	33kA	9400	27,260	31	60
	PV-160A-2XL	PV-160A-2XL-B	160	1000	33kA	2780	21,000	25	44
2	PV-200A-2XL	PV-200A-2XL-B	200	1000	33kA	4950	37,000	28	50
	PV-250A-2XL	PV-250A-2XL-B	250	1000	33kA	9450	70,000	34	60
	PV-315A-2XL	PV-315A-2XL-B	315	1000	33kA	16,600	123,000	40	66
	PV-350A-2XL	PV-350A-2XL-B	350	1000	33kA	26,000	192,000	42	68
	PV-355A-2XL	PV-355A-2XL-B	355	1000	33kA	26,000	192,000	42	68
3	PV-350A-3L	PV-350A-3L-B	350	1000	50kA	31,000	161,200	40	65
	PV-400A-3L	PV-400A-3L-B	400	1000	50kA	44,500	231,400	48	82
	PV-500A-3L	PV-500A-3L-B	500	1000	50kA	85,000	442,000	50	85
	PV-600A-3L	PV-600A-3L-B	600	1000	50kA	137,000	712,400	80	108
	PV-630A-3L*	PV-630A-3L-B*	630*	1000	50kA	137,000	712,400	92	118

* 630A thermally rated to UL only.

Data sheet: 10201

14x65mm Bussmann series PV fuses – 1300/1500Vdc, 2.5-32A



Description:

A range of 14x65mm package PV fuses specifically designed for protecting and isolating photovoltaic strings. These fuse links are capable of interrupting low overcurrents associated with faulted PV systems (reverse current, multi-array fault). Available in three mounting styles for application flexibility.

Basic fuse size:

14x65mm

Catalog symbols and mounting style:

- PV-(amp)A14LF (cylindrical)
- PV-(amp)A14L-T (cylindrical with tags)
- PV-(amp)A14LF10F (cylindrical with 10mm fixings)

Agency information:

- UL Listed, Guide JFGA, File E335324, Photovoltaic to UL 248-19
- IEC 60269-6 gPV
- CSA pending
- CCC pending
- RoHS compliant

Features and benefits:

- Specifically designed to provide fast-acting protection under low fault current conditions associated with PV systems
- Variety of mounting options for flexibility
- Fuses meet UL and IEC photovoltaic standards for global product acceptance
- Low watts loss for greater PV system efficiency
- Low heat rise permits more precise sizing

Typical applications:

- Combiner boxes • Inverters

Dimensions/configurations - mm:

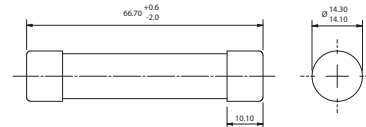

Cylindrical PV-(amp)A14LF

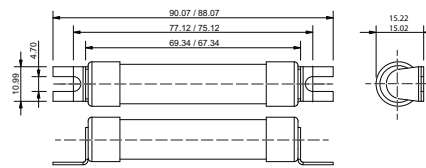

Cylindrical with tags PV-(amp)A14L-T

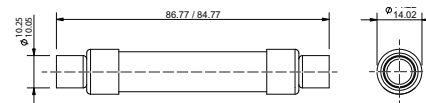

Cylindrical with 10mm fixings PV-(amp)A14LF10F

Catalog numbers (amp)/electrical characteristics:

Cylindrical	Cylindrical with tags	Cylindrical with 10mm fixings	Rated amps	Rated volts (Vdc)	Interrupting rating	I²t (A²s)		Watts loss	
						Pre-arcing	Total at rated voltage	0.8 I _n	I _n
PV-2.25A14LF	PV-2.25A14L-T	PV-2.25A14LF10F	2.25	1500	10kA	4	8	1.4	2.3
PV-2.5A14LF	PV-2.5A14L-T	PV-2.5A14LF10F	2.5	1500	10kA	5	10	1.5	2.5
PV-3A14LF	PV-3A14L-T	PV-3A14LF10F	3.0	1500	10kA	8	14	1.7	2.8
PV-3.5A14LF	PV-3.5A14L-T	PV-3.5A14LF10F	3.5	1500	10kA	12	23	1.8	3.0
PV-4A14LF	PV-4A14L-T	PV-4A14LF10F	4.0	1500	10kA	18	34	2.0	3.3
PV-15A14LF	PV-15A14L-T	PV-15A14LF10F	15	1500	10kA	14	160	3.2	5.8
PV-20A14LF	PV-20A14L-T	PV-20A14LF10F	20	1500	10kA	34	400	3.6	6.5
PV-25A14LF	PV-25A14L-T	PV-25A14LF10F	25	1300	10kA	65	550	4.1	7.5
PV-32A14LF	PV-32A14L-T	PV-32A14LF10F	32	1300	10kA	105	900	5.7	10.4

Data sheet: 1172

Bussmann series XL PV Fuses — 1500Vdc, XL01, 1, 2, 3, 50-400A



Description:

A complete range of XL size PV fuses specifically designed for protecting and isolating photovoltaic array combiners and disconnects. These fuses are capable of interrupting low overcurrents associated with faulted PV systems (reverse current, multi-array fault). Available with optional microswitches for use in monitoring systems.

Catalog symbols:

Blade — PV-(amp)A(size)XL-15
 Bolt-in — PV-(amp)A(size)XL-B-15

Agency information:

- UL Listed, Guide JFGA, File E335324. Photovoltaic to UL 248-19
- IEC 60269-6 gPV
- CSA Class 1422-30, File 53787
- RoHS compliant

Features and benefits:

- Specifically designed to provide fast-acting protection under low fault current conditions associated with PV systems
- Variety of mounting options for flexibility

Typical applications:

- Recombiner boxes
- Inverters

Recommended fuse holders:

Fuse size	Part number	Description
01XL	SB1XL-S	1-pole block
1XL	SB1XL-S	1-pole block
2XL	SB2XL-S	1-pole block
3L	SB3L-S	1-pole block

See data sheet No. 10066 for more information.

Optional microswitches:

- Blade — 170H0235 or 170H0237 for size 01XL
 — 170H0236 or 170H0238 for sizes 1XL, 2XL and 3L
- Bolt-in — 170H0069 for all sizes

Catalog numbers (amp)/electrical characteristics:

Fuse size	Bladed version	Bolt-in version	Rated amps	Rated volts (Vdc)	Interrupting rating	I ² t (A ² s)		Watts loss	
						Pre-arcing	Total @ rated volts	0.8I _n	I _n
01	PV-50A-01XL-15	PV-50A-01XL-B-15	50	1500	30kA	75	1000	14	25
	PV-63A-01XL-15	PV-63A-01XL-B-15	63	1500	30kA	362	2250	15	26
	PV-80A-01XL-15	PV-80A-01XL-B-15	80	1500	30kA	565	3300	19	35
	PV-100A-01XL-15	PV-100A-01XL-B-15	100	1500	30kA	1100	6600	22	40
	PV-125A-01XL-15	PV-125A-01XL-B-15	125	1500	30kA	2200	10,500	23	42
1	PV-160A-01XL-12	PV-160A-01XL-B-12	160	1200	30kA	5000	24,000	26	52
	PV-100A-1XL-15	PV-100A-1XL-B-15	100	1500	30kA	1250	6000	24	43
	PV-125A-1XL-15	PV-125A-1XL-B-15	125	1500	30kA	1950	9360	25	52
	PV-160A-1XL-15	PV-160A-1XL-B-15	160	1500	30kA	4200	20,160	30	58
2	PV-200A-1XL-15	PV-200A-1XL-B-15	200	1500	30kA	9400	45,120	31	61
	PV-125A-2XL-15	PV-125A-2XL-B-15	125	1500	30kA	2200	15,000	25	44
	PV-160A-2XL-15	PV-160A-2XL-B-15	160	1500	30kA	5000	32,000	29	48
	PV-200A-2XL-15	PV-200A-2XL-B-15	200	1500	30kA	8800	51,000	32	57
3	PV-250A-2XL-15	PV-250A-2XL-B-15	250	1500	30kA	16,600	85,000	40	70
	PV-250A-3L-15	PV-250A-3L-B-15	250	1500	30kA	22,300	92,000	32	50
	PV-315A-3L-15	PV-315A-3L-B-15	315	1500	30kA	38,000	160,000	36	66
	PV-355A-3L-15	PV-355A-3L-B-15	355	1500	30kA	44,500	184,000	44	80
	PV-400A-3L-15	PV-400A-3L-B-15	400	1500	30kA	58,000	240,000	49	91

Data sheet: 10201

Bussmann series HPV fuse assembly – 1000Vdc, 1-20A

RoHS



Description:

Single-pole, non-serviceable photovoltaic in-line fuse holder and fuse assembly in an IP67 dust tight and temporary water immersion resistant insulating boot for use in photovoltaic wire harnesses. Final assembly of conductors (customer supplied), insulating boots and labeling to be performed by customer following the directions contained in instruction leaflet No. 3A1963.

Catalog symbol:

HPV-DV-(amp)A

Ratings:

Volts – 1000Vdc
 Amps – 1-20A
 IR – 33kA DC

Conductors:

- 75°C/90°C Cu stranded 12-10AWG PV wire

Terminals:

- Crimp connection for single, stranded 12-10AWG PV conductor

Boot material:

- UL 5VA flammability resistant rated elastomer. UV resistant to UL F1 suitable for outdoor use.

Operating and storage temperature range:

- 40°C to +90°C

Agency information:

- UL Listed to 4248-1 and 4248-18. File E348242
- RoHS compliant
- IP20 finger-safe
- IP67

Dimensions - mm:

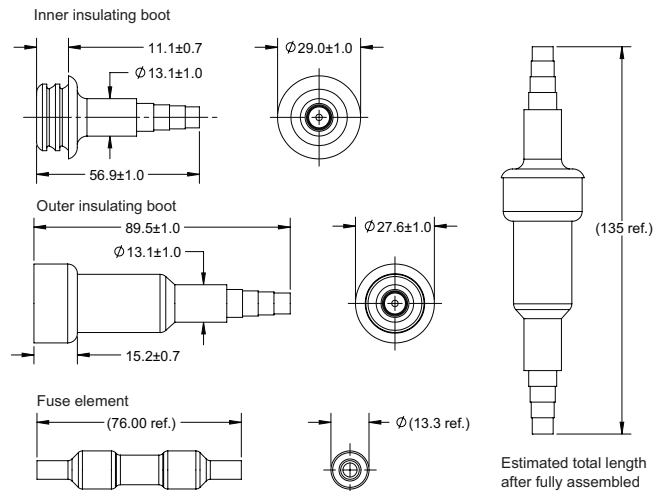

Typical applications:

- PV String wire harness protection

Recommended tools:

- Sta-Kon™ terminal crimping tool, p/n ERG4002
- Multi-contact assembly tool, p/n PV-RWZ with PV-KOI+II and PV-KOIII tapered spindles

Packing:

Bulk packed in cartons, 180 fuse assemblies per carton. Carton weight 19.3 Lbs (8.7543 kg). Fuse assemblies poly bagged with PV fuse element, two insulating boots (for lineside and loadside), and one pressure sensitive warning label to be applied on outside after complete assembly to the wire harness. For fuse element performance specifications and derating curves see data sheet No. 10121.

Catalog numbers/electrical characteristics:

Catalog number	Rated amps	Rated voltage (Vdc)	I ² t (A ² s)		Watts loss	
			Pre-arcing	Total @ rated volts	0.8I _n	I _n
HPV-DV-1A	1	1000	0.15	0.4	0.8	1.5
HPV-DV-2A	2	1000	1.2	3.4	0.6	1.0
HPV-DV-3A	3	1000	4.0	11.0	0.8	1.3
HPV-DV-3.5A	3.5	1000	6.6	18.0	0.9	1.4
HPV-DV-4A	4	1000	9.5	26.0	1.0	1.5
HPV-DV-5A	5	1000	19.0	50.0	1.0	1.6
HPV-DV-6A	6	1000	30.0	90.0	1.1	1.8
HPV-DV-8A	8	1000	3.0	32.0	1.2	2.1
HPV-DV-10A	10	1000	7.0	70.0	1.2	2.3
HPV-DV-12A	12	1000	12.0	120.0	1.5	2.7
HPV-DV-15A	15	1000	22.0	220.0	1.7	2.9
HPV-DV-20A	20	1000	34.0	350.0	2.1	3.6

Data sheet: 2157

PVGard 600Vdc and 1000Vdc PV circuit breakers



Description:

PVGard™ solar circuit breakers are part of a product family that combines a disconnect with overcurrent protection in one device to protect photovoltaic systems. PVGard breakers can also be used as a disconnect means in combiner box and inverter applications to save space.

PVGard breakers conform to the UL 489B standard for photovoltaic molded-case circuit breakers and switches, and are designed specifically for the high- and low-temperature demands of PV installations and undergo extreme ambient cycling tests. Trip units calibrate at 50°C ambient to ensure continuous operation in higher temperature environments.

Rigorous third-party testing includes limited and standard fault current tests, electrical and mechanical endurance, dielectric voltage withstand and temperature tests. PVGard products are stand-alone devices that do not require jumpers to be UL 489B listed devices.

PVGard breakers are available with accessories to provide string status, enable remote trip and ON/OFF operation, and can be customized to site requirements.

Two PVGard lineups:

- 600Vdc per-pole breakers and switches for residential and light commercial applications
- 1000Vdc poles-in-series breakers and switches for commercial and utility-scale solar systems

Available accessories:

- Flexible shaft handle mechanisms
- Electrical operator
- Undervoltage release
- Lock-off devices
- Rotary handle mechanisms
- Shunt trip
- Alarm lockout
- Terminals
- End cap kits
- Auxiliary switch

Features and benefits:

- Meets and exceeds the UL 489B standards for PV molded case circuit breakers and switches
- Designed to meet higher voltage and lower fault current levels of solar systems
- 50°C Calibrated 100% and 80% rated breakers available
- Tested to extreme ambient conditions from -40° to +90°C
- Can handle bidirectional current flow and be applied in grounded, ungrounded or bipolar systems
- Full complement of accessories for status, signaling, lockout/tagout and remote ON/OFF operation
- Ability to open on signal from DC arc or ground fault detector
- Wide range of current ratings increases options for matching incoming strings

600Vdc part number system*

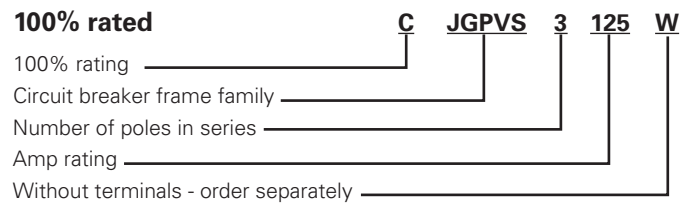
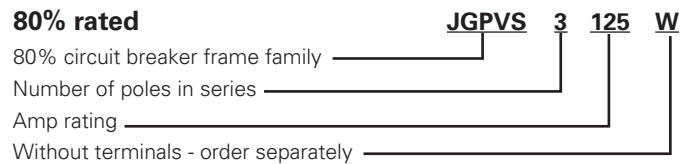

1000Vdc part number system*

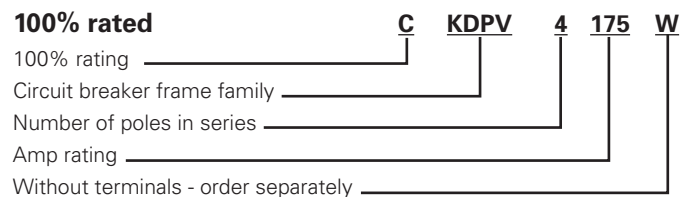
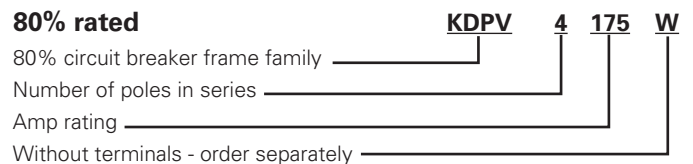

* See catalog CA08100005E for specific details on finished part number configuration.

600Vdc PVGard PV circuit breaker ratings:

Frame	JG PVS	KD PVS
Number of poles	3	3
Amps	90, 100, 125, 150, 175, 200, 225, 250A	100, 125, 150, 175, 200, 225, 250, 300, 350, 400A
Maximum voltage rating	600 Vdc	600 Vdc
Interrupting capacity at 600Vdc	1.2kA	3kA
Design ambient temperature	50°C	50°C
Third-party certification	UL 489B	UL 489B
Suitable for reverse-feed applications	Yes	Yes

Terminals - order separately. See catalog No. CA08100005E for details.

1000Vdc PVGard PV circuit breakers ratings:

Frame	FD PV	KD PV	LG PV	MDL PV
Number of poles in series	4	4	4	3
Amps	30, 40, 50, 60, 70, 80, 90, 100A	125, 150, 175, 200, 225, 250, 300, 350A	250, 300, 350, 400A	300, 350, 400, 450, 500, 600A
Maximum voltage rating	1000Vdc	1000Vdc	1000Vdc	1000Vdc
Interrupting capacity at 1000Vdc	3kA	5kA	5kA	7.5kA
Design ambient temperature	50°C	50°C	50°C	50°C
Third-party certification	UL 489B	UL 489B	UL 489B	UL 489B
Suitable for reverse-feed applications	Yes	Yes	Yes	Yes

Terminals - order separately. See catalog No. CA08100005E for details.

Series connection wiring diagrams for DC application ^{1 2}

JG PVS, KD PVS – 600Vdc per-pole

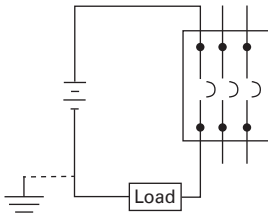

Suitable for grounded or ungrounded systems.

Suitable for quantity (3) 600Vdc circuits.

FD PV, KD PV, LG PV – 1000Vdc, four poles-in-series

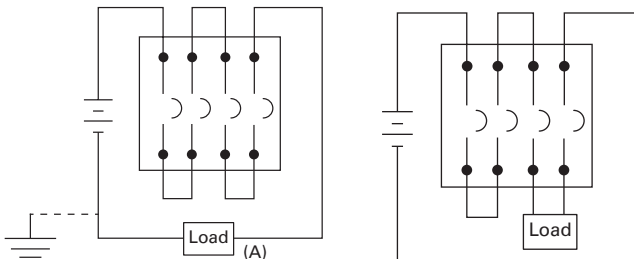

Suitable for use on ungrounded systems, or grounded systems that have one end of load (A) connected to grounded terminal, opposite poles in series connection.

Suitable for use on ungrounded systems only.

MDL PV – 1000Vdc, three poles-in-series

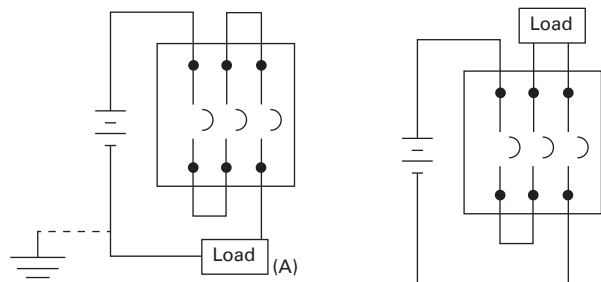

Suitable for use on ungrounded systems, or grounded systems that have one end of load (A) connected to grounded terminal, opposite poles in series connection.

Suitable for use on ungrounded systems only.

1. Poles in series connection is customer supplied. Use rated cable per NEC®.
2. For grounded systems, all poles in series must be connected on non-grounded terminal, with load connected to grounded terminal.

Technical Data: TD01211004E

Dimensions - in (mm): 600Vdc PVGard

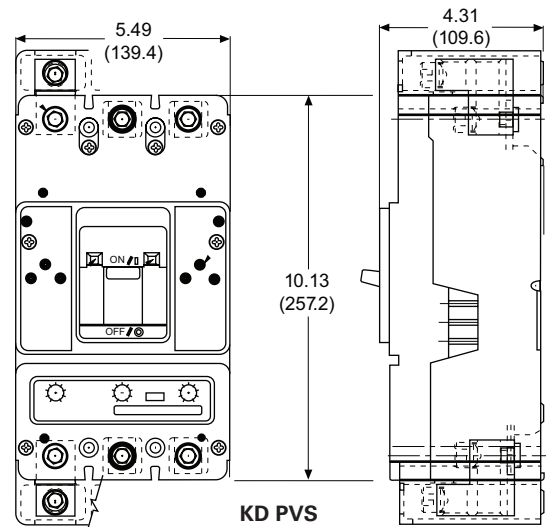
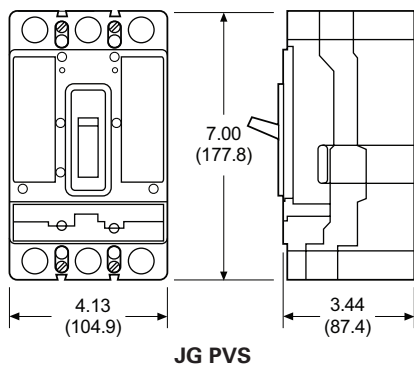

1000Vdc PVGard

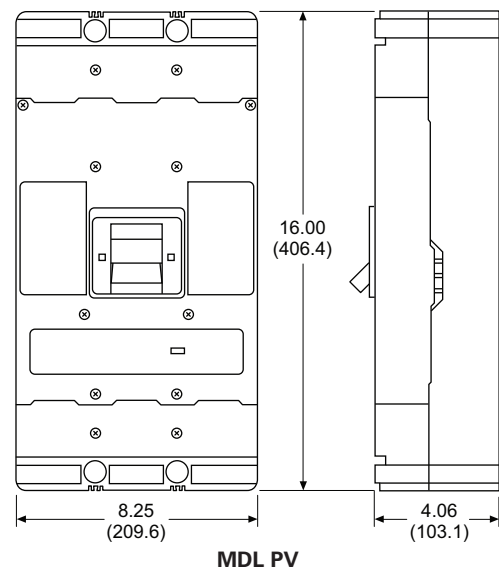
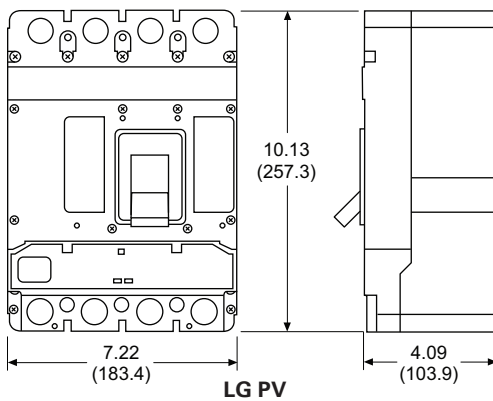
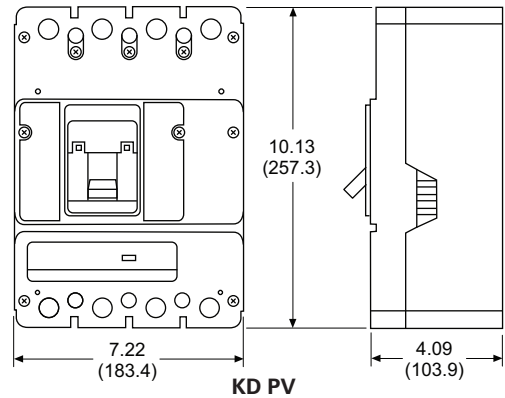
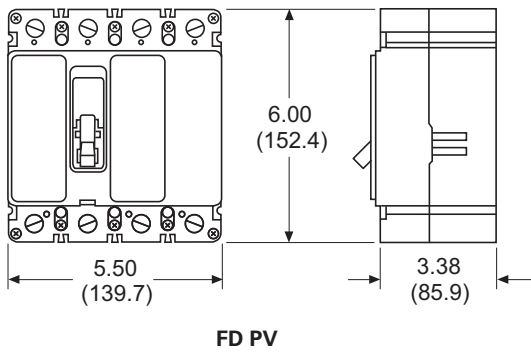

600Vdc general purpose molded case circuit breakers



Industry-leading breakers and switches for direct current applications

The Eaton DC breaker family is engineered to address the highest performance requirements while providing numerous accessories to fit different site specifications. Today's direct current applications have expanded to include solar photovoltaics, electric vehicle charging stations, battery storage and UPS systems, as well as commercial and industrial DC distribution.

Advantages

Applying more than 80 years of circuit breaker innovation, Eaton provides reliable circuit protection for DC applications ranging from 15A to 3000A emphasizing:

- Reliable operation
- Robust performance
- Enhanced safety
- Improved sustainability

Reliable operation, enhanced safety

Eaton breakers meet or exceed rigorous quality standards established by UL, providing premium quality and reliability. The DC breaker family is UL 489 Listed and exceeds the requirements in UL 489 Supplement SC for UPS applications. Eaton breakers are tested for use in both ungrounded and select grounded applications, with poles connected in series to operate at the maximum voltages shown in the table on the following page.

Robust performance

Eaton DC breakers have a contact design that forces the contact arms apart with magnetic repulsion during fault conditions. Thermal-magnetic trip units provide reliable overload and superior short-circuit protection, engineered to protect the wire and the equipment downstream of the circuit breaker from damage.

Available features and accessories

- Horizontal or vertical mounting
- Shunt trip
- Auxiliary switch
- Bell alarm
- Combination alarm/auxiliary switch
- Undervoltage release
- Handle mechanisms
- Padlockable handle lock hasp
- Electrical operators

600Vdc circuit breaker part number system

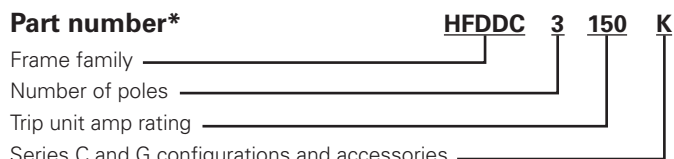

* See catalog CA08100005E for specific details on finished part number configuration.

500Vdc or 600Vdc three-pole dimensions - in (mm):

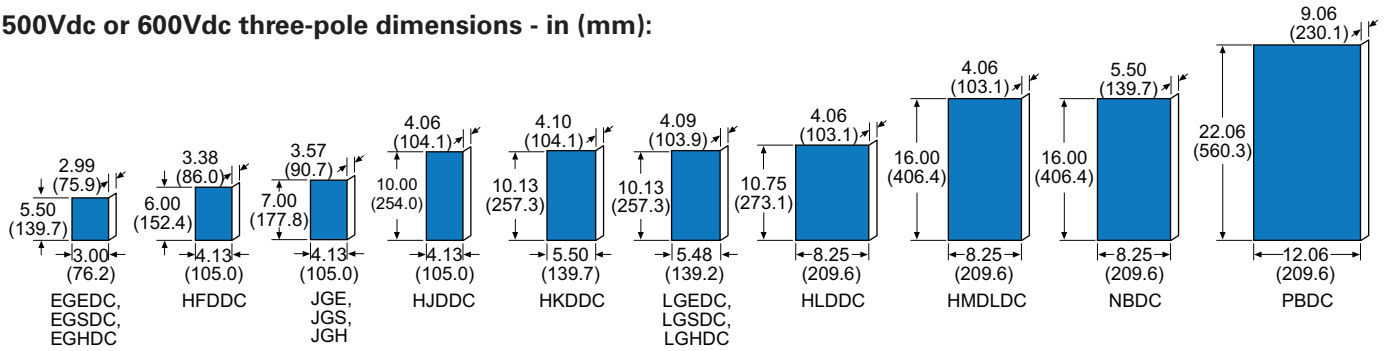

UL 489 interrupting capacity:

Circuit breaker type	Min amps	Max amps	IR (kA)@ 125Vdc	Poles in series	IR (kA)@ 250 Vdc	Poles in series	IR (kA)@ 500Vdc	IR (kA)@ 600Vdc	Poles in series	Molded case switch
EGEDC	25	100	10	1	35	2	35	—	3	Available
EGSDC	25	100	35	1	42	2	50	—	3	Available
EGHDC	25	100	42	1	50	2	65	—	3	Available
HFDDC	15	225	42	1	50	2	—	42	3	Available
JGEDC	70	250	35	1	35	2	—	35	3	Available
JGSDC	70	250	42	1	42	2	—	50	3	Available
JGHDC	70	250	50	1	50	2	—	65	3	Available
HJDDC	70	250	42	1	50	2	—	42	3	Available
HKDDC	100	400	42	1	50	2	—	42	3	Available
LGEDC	250	600	22	1	22	2	—	35	3	Available
LGSDC	250	600	22	1	22	2	—	50	3	Available
LGHDC	250	600	50	1	50	2	—	65	3	Available
HLDDC	300	600	42	1	50	2	—	35	3	Available
HLDDC*	600	1200	42	1	50	2	—	—	—	Available
HMDLDC	300	800	42	1	50	2	—	35	3	Available
NBDC	700	1200	50	1	50	2	—	50	3	N/A
RGHDC	1600	3000	50	1	50	2	—	65	3	Available

* Four-pole frame with two poles wired parallel.

DC breaker terminal wire ranges and rear connectors:

Circuit breaker frame	Max breaker amps	Terminal body material	Wire type	AWG wire range (number of conductors)	Metric wire range mm ²	Number of terminals included	Standard terminal catalog number
EGEDC, EGSDC, EGHDC	100	Aluminum	Cu/Al	14-1/0 (1)	2.5-50 (1)	3	3TA125EF
HFDDC	20	Steel	Cu/Al	14-10 (1)	2.5-4 (1)	3	3T20FB
	100	Steel	Cu/Al	14-1/0 (1)	2.5-50 (1)	3	3T100FB
JGEDC, JGSDC, JGHDC	225	Aluminum	Cu/Al	4-4/0 (1)	25-95 (1)	3	3TA225FD
	250	Stainless steel	Cu	4-350kcmil	25-185	1	T250FJ
HJDDC	250	Aluminum	Cu/Al	4-350kcmil (1)	25-185 (1)	1	TA250KB
	225	Aluminum	Cu/Al	3-350kcmil (1)	35-185 (1)	1	TA300K
HKDDC	350	Aluminum	Cu/Al	250-500kcmil (1)	120-240 (1)	1	TA350K
	400	Aluminum	Cu/Al	3/0-250kcmil (2)	95-120 (1)	3	3TA400K
LGEDC, LGSDC, LGHDC	400	Aluminum	Cu/Al	2-500kcmil (1)	35-240 (1)	1	TA350LK
	630	Aluminum	Cu/Al	2-500kcmil (2)	35-240 (2)	1/3	TA632L/3TA632LK
HLDDC	500	Aluminum	Cu/Al	3/0-350kcmil (2)	95-150 (2)	1	TA602LD
	600	Aluminum	Cu/Al	400-500kcmil (2)	185-240 (2)	3	3TA603LDK
HMDLDC	600	Aluminum	Cu/Al	1-500kcmil (2)	—	1	TA700MA1
	800	Aluminum	Cu/Al	3/0-400kcmil (3)	—	1	TA800MA2
NBDC	700	Aluminum	Cu/Al	3/0-400kcmil (3)	95-185 (3)	1	TA1000NB1
	800	Aluminum	Cu/Al	3/0-400kcmil (3)	95-185 (3)	1	TA1000NB1
	900	Aluminum	Cu/Al	3/0-400kcmil (3)	95-185 (3)	1	TA1000NB1
	1000	Aluminum	Cu/Al	3/0-400kcmil (3)	95-185 (3)	1	TA1000NB1
	1200	Aluminum	Cu/Al	4/0-500kcmil (4)	120-240 (4)	1	TA1200NB1
RGHDC (rear connectors)	1600	Copper	—	—	—	—	B2500RD
	2500	Copper	—	—	—	—	B2500RD
	2000	Copper	—	—	—	—	B2500RD
	3000	Copper	—	—	—	—	B3000RD

Bussmann series PV SPDs

- 600/1000/1200Vdc overvoltage,
- 1000Vdc lightning arrester

Description:

Our range of Bussmann series PV surge protective devices (SPDs) provides complete system protection with PV ADVANCE to suppress lightning current and PV PRO or PV HEAVY DUTY to suppress overvoltage events. Together, they protect the DC voltage section of a PV system.

Catalog numbers:

PV PRO – (base + three modules) bi-pole systems

600Vdc	W/O remote signaling	BSP3600YPV
	With remote signaling	BSP3600YPVR
	Replacement module	BPP300SYPV
1000Vdc	W/O remote signaling	BSP31000YPV
	With remote signaling	BSP31000YPVR
	Replacement module	BPP500SYPV

PV HEAVY DUTY – (base + three modules) bi-pole systems

600Vdc	W/O remote signaling	BSPH3600YPV
	With remote signaling	BSPH3600YPVR
	Replacement modules:	Outer (2) BPH300YPV Center BPM300YPV
1000Vdc	W/O remote signaling	BSPH31000YPV
	With remote signaling	BSPH31000YPVR
	Replacement modules:	Outer (2) BPH500YPV Center (1) BPM500YPV
1200Vdc	W/O remote signaling	BSPH31200YPV
	With remote signaling	BSPH31200YPVR
	Replacement modules:	Outer (2) BPH600YPV Center (1) BPM600YPV

PV HEAVY DUTY – (base + two modules) mono-pole systems

600Vdc	W/O remote signaling	BSPH2600PV
	With remote signaling	BSPH2600PVR
	Replacement modules:	Left BPH300YPV Right BPM300YPV

PV ADVANCE – (complete assembly)

1000Vdc	BSPS31000PV (complete assembly)
---------	---------------------------------

Overvoltage surge protection

PV PRO (Performance)

- 600, 1000Vdc
- Bi-Pole

PV HEAVY DUTY (Safety)

- 600, 1000, 1200Vdc
- Mono-Pole, Bi-Pole
- Integrated overcurrent protection for complete device isolation and enhanced safety



+

Lightning current protection

PV ADVANCE (Lightning)

- Combined lightning current and surge protection



= Complete System Protection

Product specifications	PV PRO	PV HEAVY DUTY	PV ADVANCE
Nominal system voltage V_O	600, 1000Vdc	600, 1000, 1200Vdc	Up to 1000Vdc
System type	Bi-pole	Mono-pole, bi-pole	Bi-pole
Protection from	Surge	Surge	Direct/indirect lightning currents
Wiring configuration / applications	"I" and "Y" configuration applications B, C and D	"I" and "Y" configuration applications B, C, D and E	Application A
Nominal discharge current I_n - IEC	20kA	12.5kA	100kA
Nominal discharge current (8x20μs) I_n - UL	20kA	10kA	—
Impulse current rating (10/350μs) I_{imp}	—	—	50kA
Max. discharge current (8x20μs) I_{max}	40kA	25kA	N/A
PV short-circuit current rating I_{scpv} amps	125A	1000A	—
Technology	MOV	MOV SCI	Trigger Spark Gap
Agency information	UL Recognized, EN 50539-11	UL Recognized, EN 50539-11	IEC 61643-11
Product warranty*	2Years	5Years	5Years
Typical product application	Combiner boxes	Recombiner boxes / inverters	Arrays / inverters

* See limited warranty statement (3A1502) for details.

Bussmann series PV PRO — performance

- UL 1449 3rd Edition Recognized, and EN 50539-11 SPDs for most popular bi-pole protection up to 600Vdc and 1000Vdc
- Modular DIN-Rail mounting with IP20 finger-safe construction makes it easy to install and maintain
- Built-in thermal disconnect technology eliminates the need for any additional fuse installation and wiring
- *easyID*[™] local visual indication and optional remote contact signaling make status monitoring simple
- Two-year warranty



Module circuit diagram

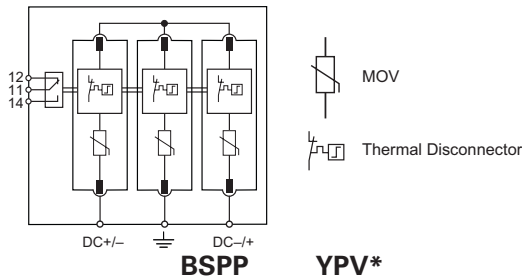

Shown with optional remote contact signaling
 * For remote signaling contact, add "R" suffix to the part number.
 E.g., BSPP3600YPVR

PV PRO "Y" series connection

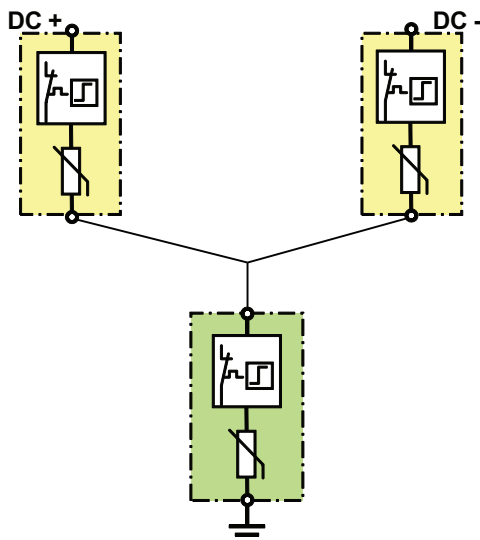

Series connection of modules between line and ground extends MOV life and permits higher voltage ratings.

Data sheet: 10091

Bussmann series PV HEAVY DUTY — safety

- Patented, fast-acting hybrid Short-Circuit Interrupting (SCI) technology isolates system to prevent damage caused by DC arcs
- UL 1449 3rd Edition Recognized and EN 50539-11 SPDs for enhanced mono- and bi-pole system protection up to 600, 1000 and 1200Vdc
- Modular DIN-Rail mounting with IP20 finger-safe construction makes it easy to install and maintain
- *easyID*[™] local visual indication and optional remote contact signaling make status monitoring simple
- Five-year warranty



Module circuit diagrams

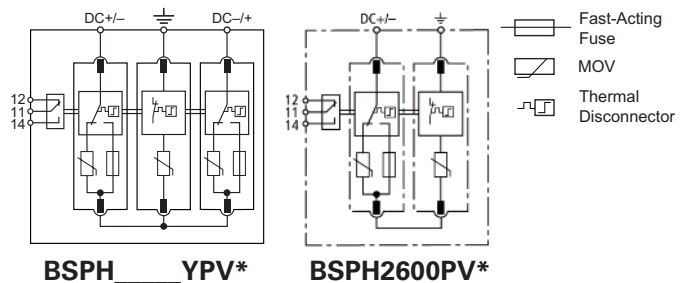

Shown with optional remote contact signaling
 * For remote signaling contact, add "R" suffix to the part number.
 E.g., BSPH3600YPVR

PV HEAVY DUTY SCI technology

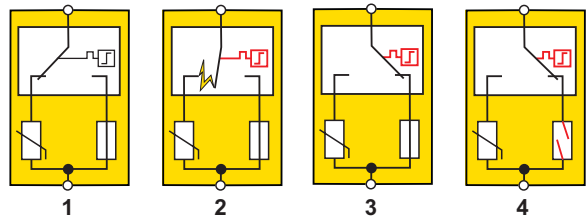

SCI technology utilizes an internal fast-acting fuse to fully isolate the SPD when a fault condition is encountered.

1. Normal operating state; conduction path is through MOV to ground.
2. MOV failure trips thermal disconnect, moving contact off the MOV and starts DC arc.
3. As contact moves, DC arc is extinguished and the contact engages the fuse.
4. Fuse opens, isolating the SPD from the system, allowing safe module replacement and continued flow of power from PV arrays to inverter.

Data sheets: 2055 (3-module) and 2145 (2-module)

Bussmann series PV ADVANCE – lightning

- Class I SPD per IEC 61643-11 standards for PV systems up to 1000V DC
- Complements and enhances total PV system protection when used in combination with PV HEAVY DUTY or PV PRO SPDs up to 1000Vdc
- Protects arrays and inverters from direct and indirect lightning strikes, and damaging surges
- Triple terminals allow multiple PV string protection with one device
- High lightning current discharge capacity using Trigger Spark Gap (TSG) technology eliminates DC short-circuit currents up to 100A DC
- Five-year warranty



Data sheet: 2148

PV wiring applications

Application A: circuit diagram and application wiring for two energized poles/modes up to 1000Vdc systems

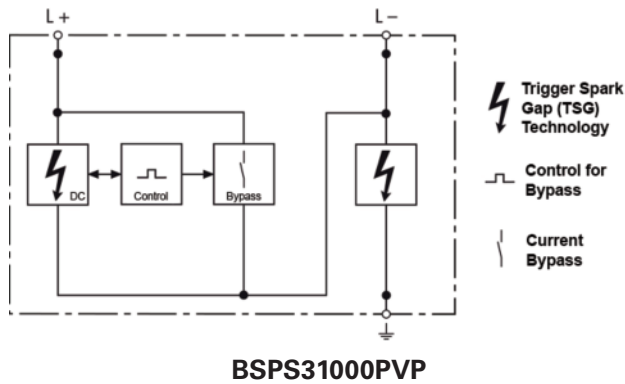

Application B: “Y” configuration - two energized poles/modes 600, 1000 and 1200Vdc* systems

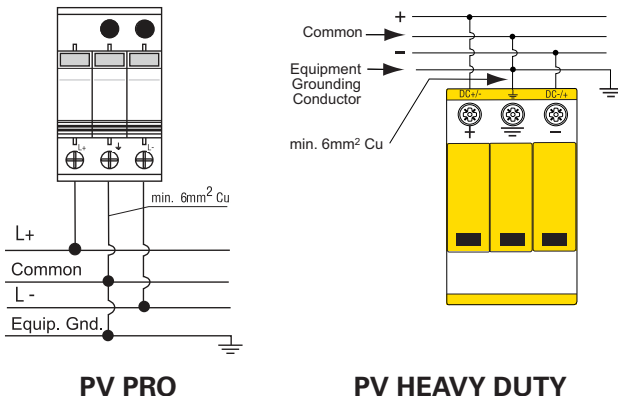

Application C: “I” configuration - one energized pole/mode 600Vdc and 1000Vdc systems only

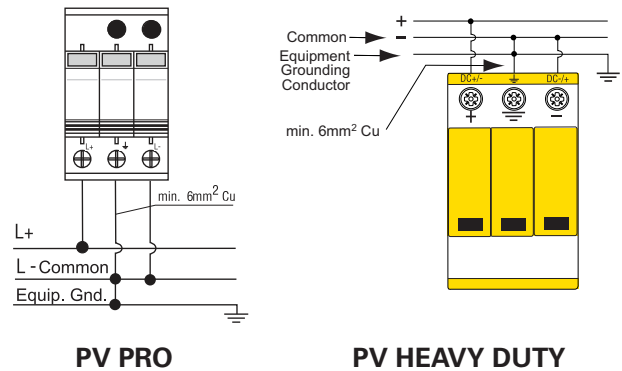

Application D: “I” Configuration - one energized pole/mode 600Vdc and 1000Vdc** systems

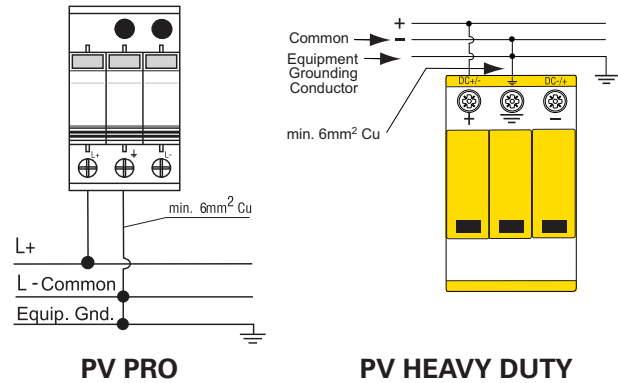

Application E: “I” configuration - one energized pole/mode 600Vdc mono-pole systems only

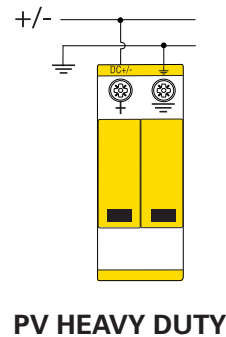

* BSPP31200YPV(R) only.

** BSPP31000YPV(R) 1000Vdc one energized pole/mode requires the following:

1. Use a suitable electrical insulator to keep a 10mm min. safety distance from the PV-SPD and other grounded parts in the housing.
2. No metal covers are permitted in the area of the module release button.

Quik-Spec Coordination Panelboard (QSCP) for solar applications



This highly configurable, compact fusible distribution panel has up to 200kA SCCR and uses the Bussmann series Compact Circuit Protector Base (CCPB) along with the time-delay or fast-acting Class CF CUBEFuse for its branch circuit disconnect means.

Its unique properties provide advantages when designing and installing large rooftop systems utilizing string inverters. It can help keep the cost of the AC balance-of-system within budget by

providing a UL 67 solution that permits combining the AC circuits from the string inverters into a single AC output.

Specific configurations of the QSCP can provide protection against high fault current levels — especially if there is a high available fault current on the AC side of the system from the utility — while keeping balance of system reasonable by using non-fused disconnects on the lineside of the string inverters.

The available NEMA 3R enclosure allows the QSCP to be installed outdoors and withstand an extreme temperature range from $-$ °F ($-$ °C) to $+$ °F ($+$ °C). And by utilizing the UL Class CF fast-acting CUBEFuse, a lower ambient derating factor can be applied so that fuse and conductor sizing can be reduced.

Specifications

- UL Listed and cULus to CSA Standard 22.2 No. 29.
- Same footprint as traditional circuit breaker panelboards 20 inches wide, and 40% smaller than standard fusible panelboards.
- Up to 400A mains, 200kA SCCR and 100A branches with 18, 30 and 42 branch positions.

Data sheet No. 1160

Eaton reference materials



Bussmann series high speed fuse application guide No. 3160

A 40-page guide on the selection and application of Bussmann series high speed fuses for protecting semiconductor devices, including inverters.

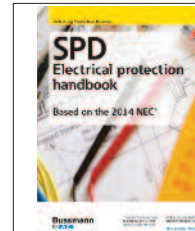

Bussmann series Selecting Protective Devices (SPD) No. 3002

Over 275 pages on the selection and application of overcurrent and overvoltage protective devices for electrical power distribution systems and machinery.

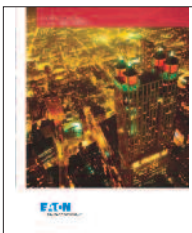

Eaton molded case circuit breaker (MCCB) full line catalog No. CA08100005E

Over 430 pages covering the AC and DC circuit protection MCCB products available from Eaton, including UL and IEC MCCBs, internal and external accessories, and more.

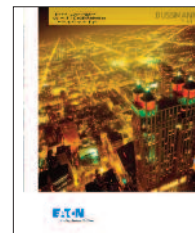













Bussmann series electrical full line catalog No. 1007

Over 530 pages covering the circuit protection products and gear available from Eaton's Bussmann Division, including UL and IEC low voltage power fuses, blocks, holders and more.

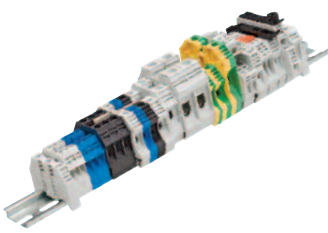

Bussmann series UL and data signal SPD guide for North American applications No. 3193

A 56-page guide on the application of UL Type 1, 2 and 3 surge protective devices for AC power systems along with UL 497B data signal SPDs for protecting twisted pair conductors, coaxial cable and RJ45 Ethernet data lines.

<p>Bussmann series UL low voltage power fuses</p> <ul style="list-style-type: none"> • Class CC - up to 100A • Class CF - up to 100A • Class J - up to 600A • Class RK1 - up to 600A • Class RK5 - up to 600A 		<p>Bussmann series IEC low voltage power fuses</p> <ul style="list-style-type: none"> • CSA Type P and D • HRC Form II • BS88 • DIN Type D • NH HRC • gG/gL 	
<p>Bussmann series AC rotary disconnect switches</p> <ul style="list-style-type: none"> • 600Vac • 250Vdc* • NEMA® 1, 3R, 12, 4, 4X • UL 98 <p>* On select switches.</p>		<p>Bussmann series DC safety switches</p> <ul style="list-style-type: none"> • 600Vdc • 30, 60, 100 and 200A • Fusible and non-fusible • NEMA 3R, 12, 4X • UL 98, UL 50 	
<p>Bussmann series high speed fuses</p> <ul style="list-style-type: none"> • North American • Square body • BS88 • Ferrule 		<p>Bussmann series UL and IEC SPDs</p> <ul style="list-style-type: none"> • UL SPDs (up to 600V) <ul style="list-style-type: none"> - Type 1, NEMA 1 and 4X - Type 2, DIN-Rail • IEC SPDs (up to 600V) <ul style="list-style-type: none"> - Class I and II - Up to 4-poles 	
<p>Bussmann series DIN-Rail terminal blocks</p> <ul style="list-style-type: none"> • Feed-through • Double level • Disconnect • Grounding • Fuse holder • Internally jumpered • Test 		<p>Eaton general DC molded case circuit breakers and switches</p> <ul style="list-style-type: none"> • 600Vdc (up to 750Vdc) • Up to 3000A • Various interrupting ratings up to 65kAIC 	
<p>Eaton AC molded case circuit breakers and switches</p> <ul style="list-style-type: none"> • 600V (up to 1000Vac) • Up to 2500A • Various interrupting ratings up to 200kAIC 		<p>Bussmann series data signal surge protective devices</p> <ul style="list-style-type: none"> • Universal 4-wire • BNC coaxial cable • RJ45 Ethernet 	
<p>Bussmann series modular fuse holders</p> <ul style="list-style-type: none"> • DIN-Rail mount • Up to 4-poles • Class CC and J • 8x32, 10x38, 14x51 and 22x58mm 		<p>Bussmann series modular knifeblade fuse blocks</p> <ul style="list-style-type: none"> • Class J, R and H (K) • 70 to 600A • Optional finger-safe covers 	

Eaton
1000 Eaton Boulevard
Cleveland, OH 44122
United States
Eaton.com

Bussmann Division
114 Old State Road
Ellisville, MO 63021
United States
Eaton.com/bussmannseries

©2017 Eaton
All Rights Reserved
Printed in USA
Publication No. 10191 — BU-SB14309
October 2017

Eaton, Bussmann and CUBEFuse are valuable trademarks of Eaton in the US and other countries. You are not permitted to use the Eaton trademarks without prior written consent of Eaton.

CSA is a registered trademark of the Canadian Standards Group.
IEC is a registered trademark of the International Electrotechnical Commission.

NEC is a registered trademark of the National Fire Protection Association, Inc.

NEMA is a registered trademark of the National Electrical Manufacturers Association.

UL is a registered trademark of the Underwriters Laboratories, Inc.

For Eaton's Bussmann series product information, call **1-855-287-7626** or visit: **Eaton.com/bussmannseries**

Follow us on social media to get the latest product and support information.

