

CDB5460AU Evaluation Board and Software

Features

- ❑ Voltage and Current Interface
- ❑ USB Communication with PC
- ❑ On-board C8051F320 Microcontroller
- ❑ On-board Voltage Reference
- ❑ LabWindows®/CVI® GUI Software
 - Register Setup & Chip Control
 - FFT Analysis
 - Time Domain Analysis
 - Noise Histogram Analysis
- ❑ "Auto-boot" Demo with Serial EEPROM

General Description

The CDB5460AU is an inexpensive tool designed to evaluate the functionality and performance of the CS5460A. The evaluation board includes an LT1019 voltage reference, a C8051F320 microcontroller with a USB interface, and firmware. The microcontroller controls the serial communication between the evaluation board and the PC via the firmware, enabling quick and easy access to all of the CS5460A's registers and functions.

The CDB5460AU includes software for data capture, time domain analysis, histogram analysis, and frequency domain analysis.

Schematics in PADS™ PowerLogic™ format are available for download at www.cirrus.com/IndustrialSoftware.

ORDERING INFORMATION

CDB5460AU

Evaluation Board

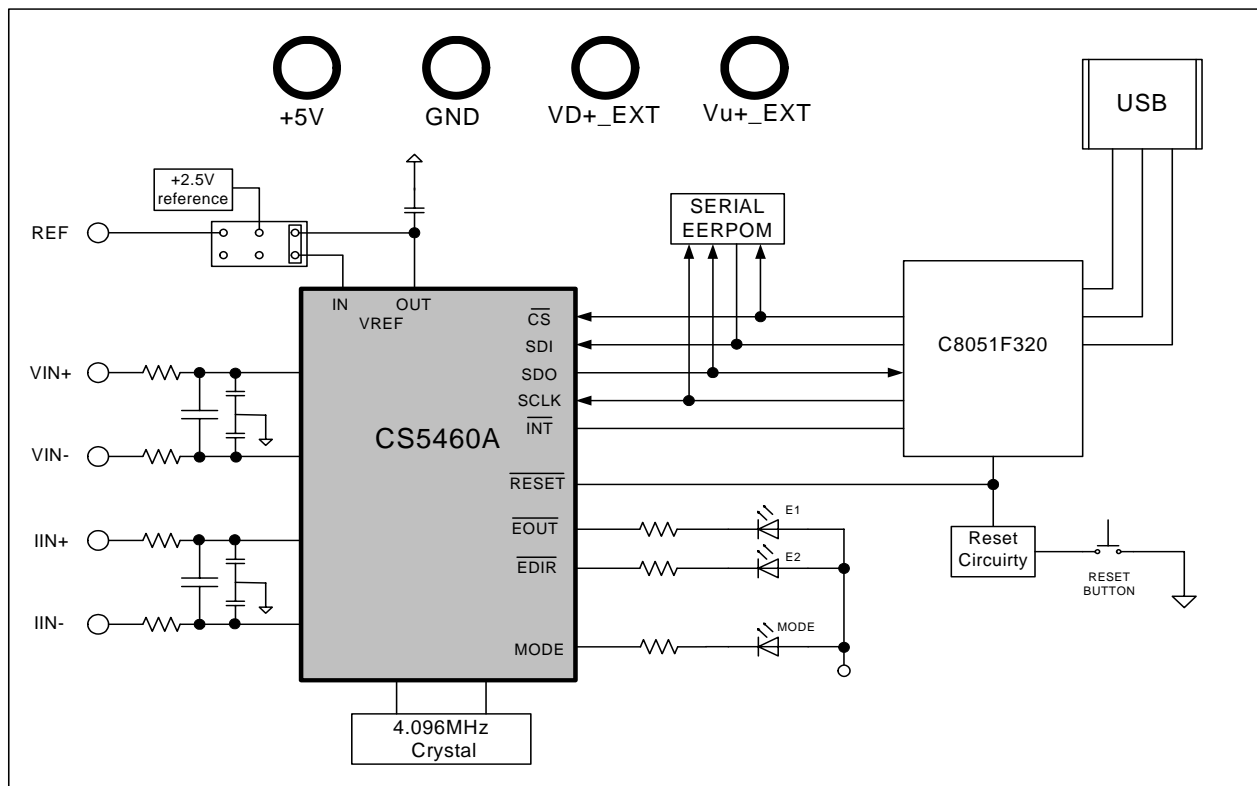

TABLE OF CONTENTS

1. HARDWARE	3
1.1 Introduction	3
1.2 Evaluation Board Overview	3
1.3 Analog Section	4
1.4 Digital Section	5
1.5 Power Supply Section	5
1.6 Auto-boot Mode	6
2. SOFTWARE	8
2.1 Installation	8
2.2 Using the Software	8
2.3 Start-up Window	8
2.4 <i>Setup</i> Window	12
2.5 Calibration Windows	14
2.6 Conversion Window	16
2.7 Pulse Rate Window	17
2.8 Data Collection Window	18
2.9 EEPROM Window	25
2.10 Debug Panel	26
Appendix A. Bill Of Materials	27
Appendix B. Schematics	29
Appendix C. Layer Plots	33
FIGURE 26. REVISION HISTORY	37

LIST OF FIGURES

Figure 1. CDB5460AU Assembly Drawing	3
Figure 2. GUI Start-up Window	8
Figure 3. <i>Setup</i> Menu Showing Successful USB Connection	9
Figure 4. <i>USB Error Message</i>	9
Figure 5. <i>Data from Disc</i> File Selection Window	10
Figure 6. <i>Menu Pull-down Options</i>	10
Figure 7. <i>Quit Dialog</i>	11
Figure 8. <i>Setup</i> Window	12
Figure 9. <i>Calibration</i> Window	14
Figure 10. <i>Conversion</i> Window	16
Figure 11. <i>Pulse Rate Output</i> Window	17
Figure 12. <i>Data Collection</i> Window	18
Figure 13. <i>Configuration</i> Window	19
Figure 14. <i>Histogram Analysis</i>	21
Figure 15. <i>FFT Analysis</i>	23
Figure 16. <i>Time Domain Analysis</i>	24
Figure 17. <i>EEPROM</i> Window	25
Figure 18. <i>Debug Panel</i>	26
Figure 19. Schematic - Analog Inputs	29
Figure 20. Schematic - CS5460A & Socket	30
Figure 21. Schematic - Microcontroller & USB Interface	31
Figure 22. Schematic - Power Supplies	32
Figure 23. Top Silkscreen	33
Figure 24. Top Routing	34
Figure 25. Bottom Routing	35
Figure 26. Bottom Silkscreen	36

1. HARDWARE

1.1 Introduction

The CDB5460AU evaluation board provides a quick means of evaluating the CS5460A power measurement IC. The CDB5460AU evaluation board operates from a single +5 V power supply. The evaluation board interfaces the CS5460A to a PC via an USB interface. To accomplish this, the board comes equipped with a C8051F320 microcontroller and a USB interface. Additionally, CDB5460AU GUI software provides easy access to the internal registers of the CS5460A, and provides a means to display the performance in the time domain or the frequency domain.

1.2 Evaluation Board Overview

The board is partitioned into two main sections: analog and digital. The analog section consists of the CS5460A and a precision voltage reference. The digital section consists of the C8051F320 microcontroller, EEPROM, the hardware test switches, the reset circuitry, and the USB interface. The board also has a user friendly power supply connection.

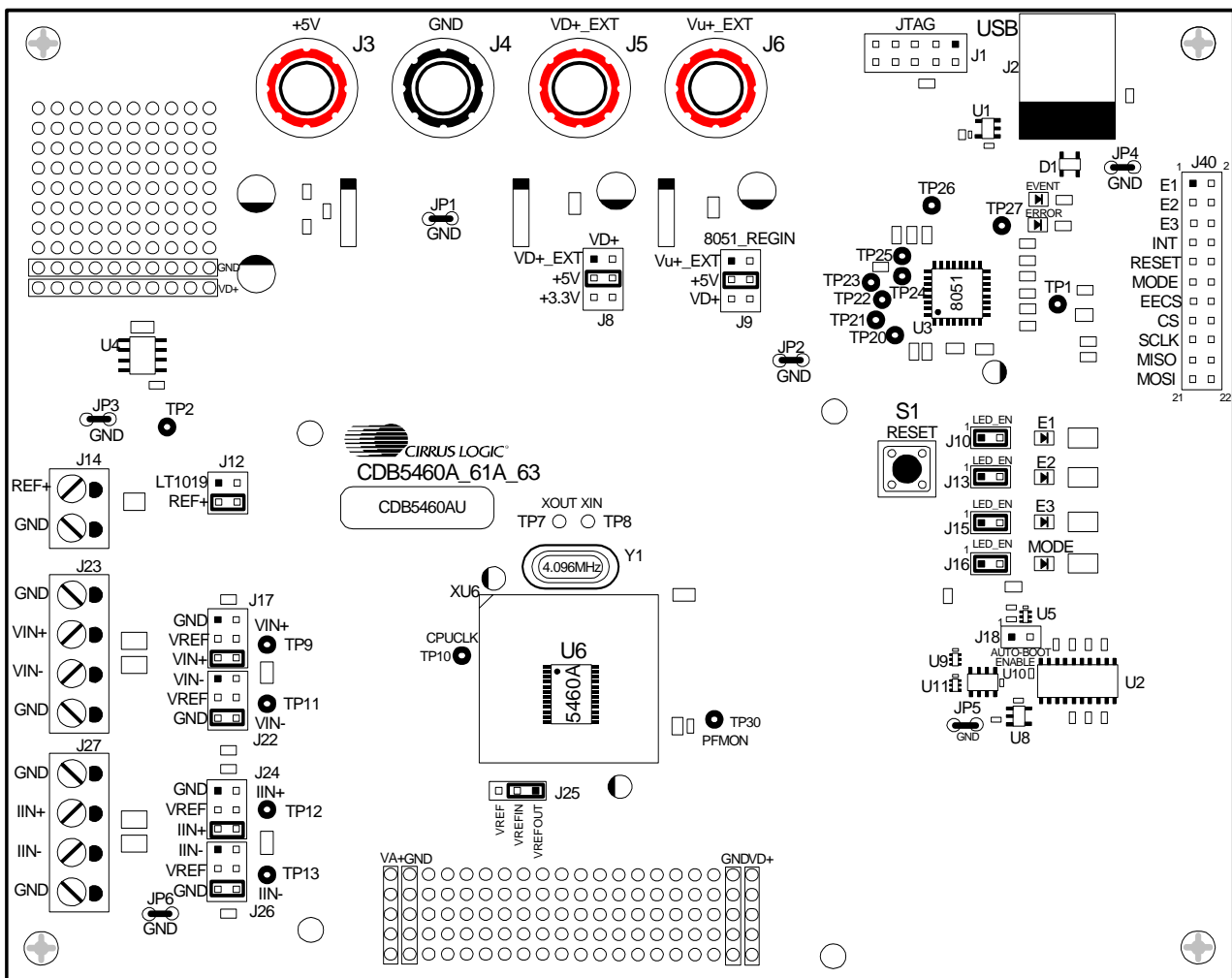

Figure 1. CDB5460AU Assembly Drawing

1.3 Analog Section

The CDB5460AU evaluation board provides screw-type terminals (J23, J27) to connect input signals to the voltage and current channels. The screw terminals are labels as VIN+, VIN-, IIN+, and IIN-. A simple RC network at each channel input provides a simple anti-alias filter.

The evaluation board provides three voltage reference options for VREFIN to the CS5460A. The three voltage reference options include: VREFOUT from the CS5460A, the on-board +2.5V reference, and external REF+ (screw terminal J14). Table 1 and Table 2 illustrate the options available for VREFIN. With a jumper on J25 in the position labeled VREFOUT, the reference is supplied by the on-chip voltage reference. With a jumper on J25 in the position labeled VREF, the reference is supplied by an off-chip voltage reference.

Reference	Description	J25
VREFOUT	Selects On-chip Reference (30 ppm/°C)	VREF <input type="radio"/> VREFIN <input checked="" type="radio"/> VREFOUT <input type="radio"/> <i>(Default)</i>
VREF	Selects External or LT1019 Reference(J12)	VREF <input checked="" type="radio"/> VREFIN <input type="radio"/> VREFOUT <input type="radio"/>

Table 1. Internal Voltage Reference Selection for VREF

Table 2 illustrates the options available for VREF. With a jumper on J12 in position *LT1019*, the LT1019 provides a +2.5V reference (the LT1019 was chosen for its low drift — typically 20ppm/°C). By setting the jumper on J12 to position REF+, an external voltage reference is supplied via screw terminal J14's REF+ input.

Reference	Description	J12
LT1019	Selects On-board LT1019 Reference (20 ppm/°C)	LT1019 <input checked="" type="radio"/> VREF REF+ <input type="radio"/> VREF
REF+	Selects External Reference Source (J14)	LT1019 <input type="radio"/> VREF REF+ <input checked="" type="radio"/> VREF <i>(Default)</i>

Table 2. External Voltage Reference Selection for VREF

The three input signal options for the voltage (VIN±) and current (IIN±) channel input include: an external signal (screw terminals J23 and J27), GND, or VREF. Table 3 illustrates the options available. By installing jumpers on J17 to position VIN+, J22 to position VIN-, J24 to position IIN+, and J26 to position IIN-, the input voltage signal is supplied from the screw terminals J23 and J27. With a jumper on J17, J22, J24, and J26 in the *GND* position, the inputs

are connected to analog ground (AGND). With a jumper on J17, J22, J24, and J26 in position *VREF*, the inputs are connected to the reference voltage selected on J12.

INPUT	Description	J17	J22	J24	J26
VIN± or IIN±	Selects External Signal	GND <input type="checkbox"/> VIN+ <input type="checkbox"/> VREF <input type="checkbox"/> VIN+ <input type="checkbox"/> VIN+ <input checked="" type="checkbox"/> VIN+ <input type="checkbox"/> <i>(Default)</i>	VIN- <input type="checkbox"/> VIN- <input type="checkbox"/> VREF <input type="checkbox"/> VIN- <input type="checkbox"/> GND <input checked="" type="checkbox"/> VIN- <input type="checkbox"/> <i>(Default)</i>	GND <input type="checkbox"/> IIN+ <input type="checkbox"/> VREF <input type="checkbox"/> IIN+ <input type="checkbox"/> IIN+ <input checked="" type="checkbox"/> IIN+ <input type="checkbox"/> <i>(Default)</i>	IIN- <input type="checkbox"/> IIN- <input type="checkbox"/> VREF <input type="checkbox"/> IIN- <input type="checkbox"/> GND <input checked="" type="checkbox"/> IIN- <input type="checkbox"/> <i>(Default)</i>
VIN± or IIN±	Selects External Signal	GND <input type="checkbox"/> VIN+ <input type="checkbox"/> VREF <input type="checkbox"/> VIN+ <input type="checkbox"/> VIN+ <input checked="" type="checkbox"/> VIN+ <input type="checkbox"/>	VIN- <input checked="" type="checkbox"/> VIN- <input type="checkbox"/> VREF <input type="checkbox"/> VIN- <input type="checkbox"/> GND <input type="checkbox"/> VIN- <input type="checkbox"/>	GND <input type="checkbox"/> IIN+ <input type="checkbox"/> VREF <input type="checkbox"/> IIN+ <input type="checkbox"/> IIN+ <input checked="" type="checkbox"/> IIN+ <input type="checkbox"/>	IIN- <input checked="" type="checkbox"/> IIN- <input type="checkbox"/> VREF <input type="checkbox"/> IIN- <input type="checkbox"/> GND <input type="checkbox"/> IIN- <input type="checkbox"/>
GND	Selects Grounding the Input	GND <input checked="" type="checkbox"/> VIN+ <input type="checkbox"/> VREF <input type="checkbox"/> VIN+ <input type="checkbox"/> VIN+ <input type="checkbox"/> VIN+ <input type="checkbox"/>	VIN- <input type="checkbox"/> VIN- <input type="checkbox"/> VREF <input type="checkbox"/> VIN- <input type="checkbox"/> GND <input checked="" type="checkbox"/> VIN- <input type="checkbox"/>	GND <input checked="" type="checkbox"/> IIN+ <input type="checkbox"/> VREF <input type="checkbox"/> IIN+ <input type="checkbox"/> IIN+ <input type="checkbox"/> IIN+ <input type="checkbox"/>	IIN- <input type="checkbox"/> IIN- <input type="checkbox"/> VREF <input type="checkbox"/> IIN- <input type="checkbox"/> GND <input checked="" type="checkbox"/> IIN- <input type="checkbox"/>
VREFIN	Selects Reference Source	GND <input type="checkbox"/> VIN+ <input type="checkbox"/> VREF <input checked="" type="checkbox"/> VIN+ <input type="checkbox"/> VIN+ <input type="checkbox"/> VIN+ <input type="checkbox"/>	VIN- <input type="checkbox"/> VIN- <input type="checkbox"/> VREF <input checked="" type="checkbox"/> VIN- <input type="checkbox"/> GND <input type="checkbox"/> VIN- <input type="checkbox"/>	GND <input type="checkbox"/> IIN+ <input type="checkbox"/> VREF <input checked="" type="checkbox"/> IIN+ <input type="checkbox"/> IIN+ <input type="checkbox"/> IIN+ <input type="checkbox"/>	IIN- <input type="checkbox"/> IIN- <input type="checkbox"/> VREF <input checked="" type="checkbox"/> IIN- <input type="checkbox"/> GND <input type="checkbox"/> IIN- <input type="checkbox"/>

Table 3. Voltage and Current Channel Input Signal Selection

1.4 Digital Section

The digital section contains the microcontroller, USB interface, JTAG header, reset circuitry, and an external interface header (J40). The microcontroller interfaces the SPI™ of CS5460A with the USB connection to the PC, enabling GUI software to access all the CS5460A registers and functions. Interface header, J40, is provided to allow the CDB5460AU to be connected to an external energy registration device or an external microcontroller. To connect the CS5460A to an external microcontroller, R57, R58, R59, R60, R61, and R62 must be removed from the board. The energy output pins EOUT, EDIR are routed to LEDs (E1, E2) which provide a simple visual check of the energy output pulses. Mode pin is also routed to a LED to indicate whether the CS5460A is at auto-boot mode. Jumpers J10, J13, J15, and J16 are equipped at the factory with jumpers to enable the LEDs.

1.5 Power Supply Section

Table 4 illustrates the power supply connections to the evaluation board. The +5V binding post (J3) supplies the positive analog (VA+) for the CS5460A and the on-board +2.5V reference. The VD+_EXT binding post (J5) supplies the digital section of the CS5460A (VD+) and level shifters. Jumper J8 allows the VD+ supply to be sourced from the VD+_EXT binding post (J5), the +5V binding post (J3), or the regulated 3.3V supply derived from the microcontroller. The Vu+_EXT (J6) binding post supplies the positive supply

for the 8051 microcontroller (*8051_REGIN*). Jumper J9 allows the *8051_REGIN* supply to be sourced from either the *Vu+_EXT* binding post (J6), +5V binding post (J3) or *VD+_EXT* binding post (J5).

Power Supplies			Power Post Connections				VD+	8051-REGIN
Analog (VA+)	Digital (VD+)	8051 (Vu+)	+5V	GND	VD+EXT	VU+EXT	J8	J9
+5	+5	+5	+5	0	NC	NC	VD+_EXT <input type="checkbox"/> VD+ +5 <input checked="" type="radio"/> VD+ +3.3 <input type="radio"/> VD+ <i>(Default)</i>	Vu+_EXT <input type="checkbox"/> 8051 +5 <input checked="" type="radio"/> 8051 VD+ <input type="radio"/> 8051 <i>(Default)</i>
						+5	VD+_EXT <input type="checkbox"/> VD+ +5 <input checked="" type="radio"/> VD+ +3.3 <input type="radio"/> VD+	Vu+_EXT <input checked="" type="radio"/> 8051 +5 <input type="radio"/> 8051 VD+ <input type="radio"/> 8051
					+5	NC	VD+_EXT <input checked="" type="radio"/> VD+ +5 <input type="radio"/> VD+ +3.3 <input type="radio"/> VD+	Vu+_EXT <input type="checkbox"/> 8051 +5 <input checked="" type="radio"/> 8051 VD+ <input type="radio"/> 8051
						+5	VD+_EXT <input checked="" type="radio"/> VD+ +5 <input type="radio"/> VD+ +3.3 <input type="radio"/> VD+	Vu+_EXT <input checked="" type="radio"/> 8051 +5 <input type="radio"/> 8051 VD+ <input type="radio"/> 8051
					NC	+5	VD+_EXT <input type="checkbox"/> VD+ +5 <input checked="" type="radio"/> VD+ +3.3 <input type="radio"/> VD+	Vu+_EXT <input checked="" type="radio"/> 8051 +5 <input type="radio"/> 8051 VD+ <input type="radio"/> 8051
+5	+3.3	+5	+5	0	NC	NC	VD+_EXT <input type="checkbox"/> VD+ +5 <input type="radio"/> VD+ +3.3 <input checked="" type="radio"/> VD+	Vu+_EXT <input type="checkbox"/> 8051 +5 <input checked="" type="radio"/> 8051 VD+ <input type="radio"/> 8051
						+5	VD+_EXT <input type="checkbox"/> VD+ +5 <input type="radio"/> VD+ +3.3 <input checked="" type="radio"/> VD+	Vu+_EXT <input checked="" type="radio"/> 8051 +5 <input type="radio"/> 8051 VD+ <input type="radio"/> 8051
					+3.3	NC	VD+_EXT <input checked="" type="radio"/> VD+ +5 <input type="radio"/> VD+ +3.3 <input type="radio"/> VD+	Vu+_EXT <input type="checkbox"/> 8051 +5 <input checked="" type="radio"/> 8051 VD+ <input type="radio"/> 8051
						+5	VD+_EXT <input checked="" type="radio"/> VD+ +5 <input type="radio"/> VD+ +3.3 <input type="radio"/> VD+	Vu+_EXT <input checked="" type="radio"/> 8051 +5 <input type="radio"/> 8051 VD+ <input type="radio"/> 8051

Table 4. Power Supply Connections

1.6 Auto-boot Mode

With a jumper connection on J18 (*AUTO-BOOT ENABLE*), the CS5460A operates in auto-boot mode and the CDB5460AU board operates as a stand-alone system without attaching it to a PC. When in auto-boot mode, a hardware reset (press on S1) will cause the CS5460A to boot up using the serial data from the serial EEPROM on the board (U10). When the CS5460A is in auto-boot mode, the SPI™ connections between the microcontroller and the CS5460A are removed and the GUI software can not access the CS5460A registers and functions.

The EEPROM must be programmed prior to the auto-boot sequence. When the CDB5460AU Evaluation Board is sent from the factory, the EEPROM is programmed with the following CS5460A command/data sequence:

1. Set Configuration Register, turn high-pass filters on, set K = 1:
0x40 0x00 0x00 0x61
2. Set Pulse_Rate Register to 1000 Hz:
0x4C 0x00 0x7D 0x00
3. Set (Unmask) bit 2 (LSD) in the Mask Register:
0x74 0x00 0x00 0x04
4. Start continuous conversion:
0xE8
5. Write STOP bit in Control register, to terminate auto-boot sequence:
0x78 0x00 0x01 0x00

This sequence programs the CS5460A for continuous conversion mode. If voltage and current signals are applied to the inputs, the CS5460A will issue pulses on the $\overline{\text{EOUT}}$ pin. See the CS5460A data sheet for more details on auto-boot.

2. SOFTWARE

The evaluation board comes with software and an USB cable to link the evaluation board to the PC. The evaluation software was developed with LabWindows®/CVI®, a software development package from national Instruments. The evaluation software is available for download on the Cirrus Logic web site at <http://www.cirrus.com/industrialsoftware> and was designed to run under Windows® 2000 or Windows XP®.

2.1 Installation

To install the software, go to the Cirrus Logic web site at <http://www.cirrus.com/industrialsoftware> and refer to application note AN278.

2.2 Using the Software

Before launching the software, check all jumper settings on the CDB5460AU evaluation board as described in Section 1, and connect the board to an open USB port on the PC using the provided cable. Once the board is powered on, the software program can be launched.

2.3 Start-up Window

When the software is launched, the start-up window will appear. This window contains information concerning the software's title, revision number, copyright date, etc. See Figure 2.

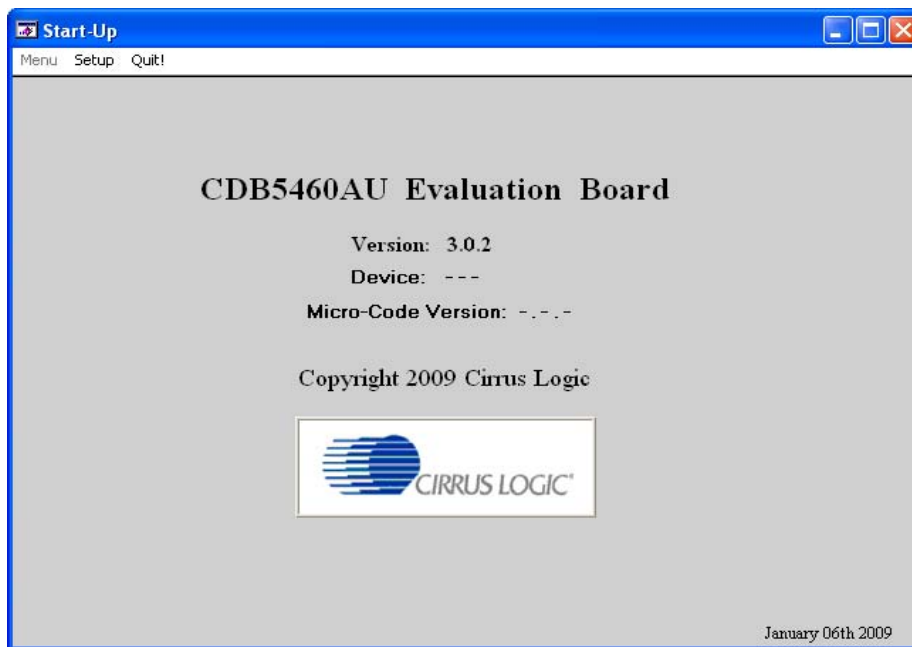

Figure 2. GUI Start-up Window

At the top of the screen is a menu bar which displays user options. The menu bar has three items: *Menu*, *Setup*, and *Quit*. Initially *Menu* is disabled. After establishing a link to a data source, the *Menu* item will become available.

2.3.1 Setup Menu

Setup allows user to establish a USB communication connection with CDB5460AU board or select a previously saved data file for further analysis.

If the *USB* item in the *Setup* menu is selected, the evaluation software will poll the CDB5460AU, verifying the serial communication link is ready. At this point, the *USB* menu item is checked indicating that the PC has successfully communicated with CDB5460AU evaluation board, and device and micro-code version information are read from the board and displayed on the screen. See Figure 3. Due to improvements to the software or new features being added, the version displayed may be different than the image shown here.

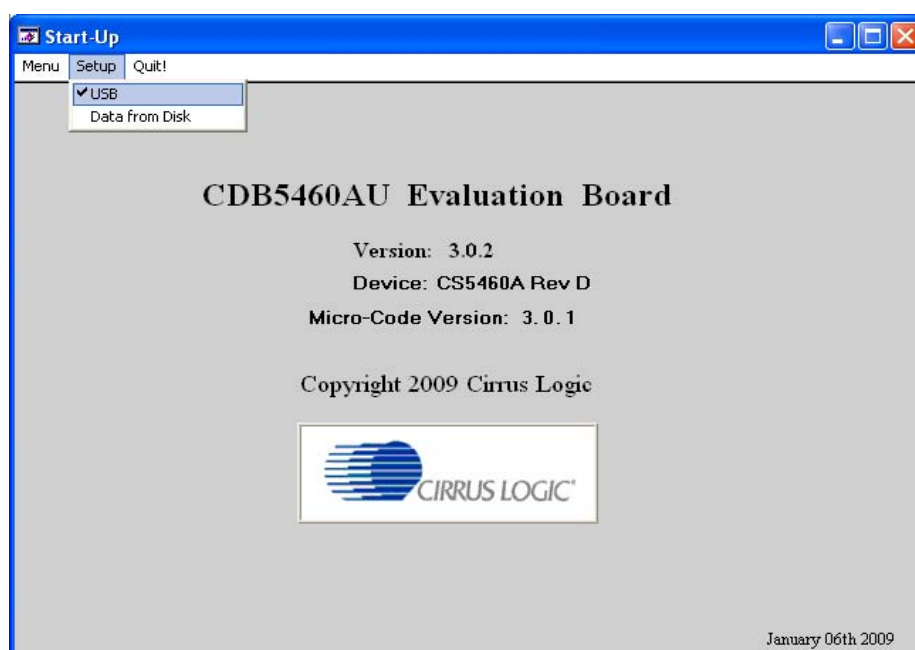

Figure 3. Setup Menu Showing Successful USB Connection

If the evaluation software is unable to establish a communication link with the CDB5460AU board, a message will appear, indicating that the initial communication has failed. See Figure 4.



Figure 4. USB Error Message

Check to verify that the USB cable is connected properly and the power supply is on and connected properly to the CDB5460AU. Reset the board (press the *RESET* button on the board) and try to setup the USB connection again.

If the *Data from Disk* item in the *Setup* menu is selected, a file selection window will appear as shown in Figure 5. User can select a pre-saved data file for further analysis using time domain, FFT, and histogram plots in Data Collection Window of the software.

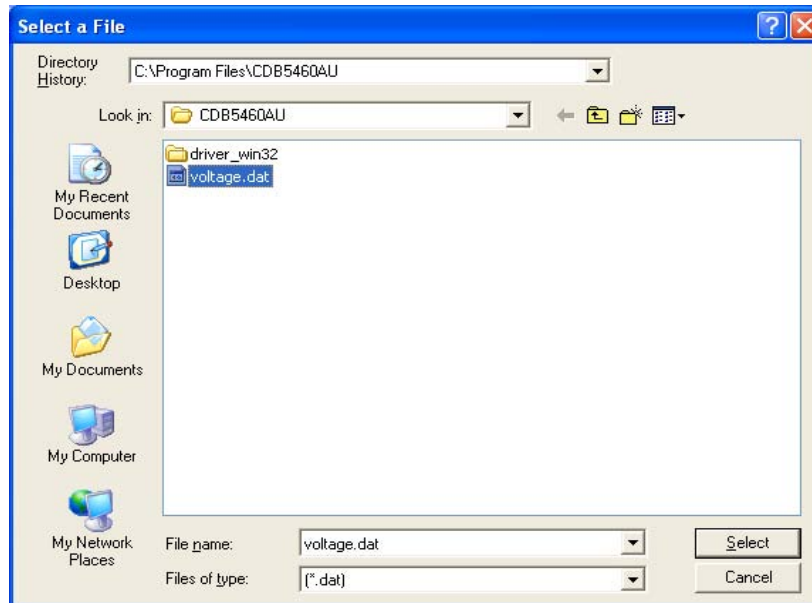

Figure 5. Data from Disc File Selection Window

2.3.2 Menu Pull-down

Excluding the *Start-Up* window, the *Menu* pull-down provides 7 options: *Setup Window*, *Calibration Window*, *Conversion Window*, *Pulse Rate Window*, *Data Collection Window*, *EEPROM Window*, and *Debug Window*. Each window provides a means to evaluate the different functions and performance of the CS5460A. Each option has an associated function key (<F1>, <F2>, etc.). See Figure 6.

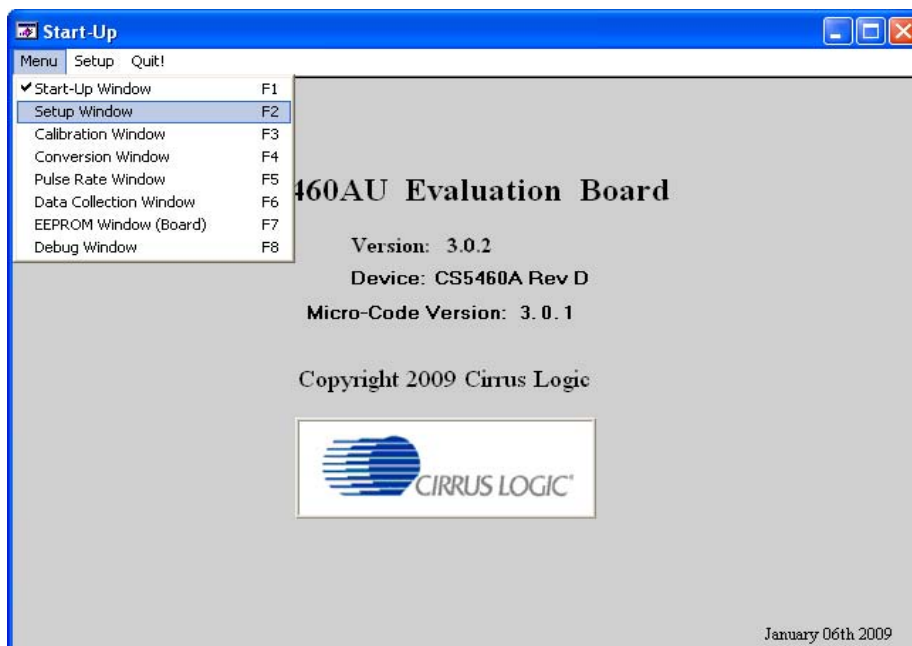

Figure 6. Menu Pull-down Options

2.3.3 *Quit* Menu

The *Quit* menu allows the user to exit the evaluation software. Upon selecting *Quit*, a message window appears and queries if exiting the evaluation software is desired. See Figure 7.

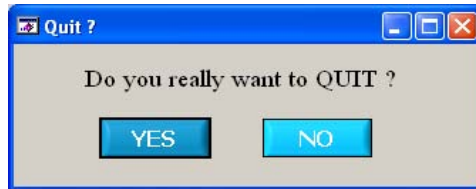

Figure 7. *Quit* Dialog

2.4 Setup Window

The evaluation software provides access to the CS5460A's internal registers through the *Setup* window. See Figure 8. The user can enter the *Setup* window by pulling down the *Menu* menu and selecting *Setup Window*, or by pressing <F2> on the keyboard.

In the *Setup* window, all of the CS5460A's registers are displayed in hexadecimal notation and are decoded to provide easier readability. Refer to the CS5460A data sheet for information on register functionality and definitions. See Figure 8.

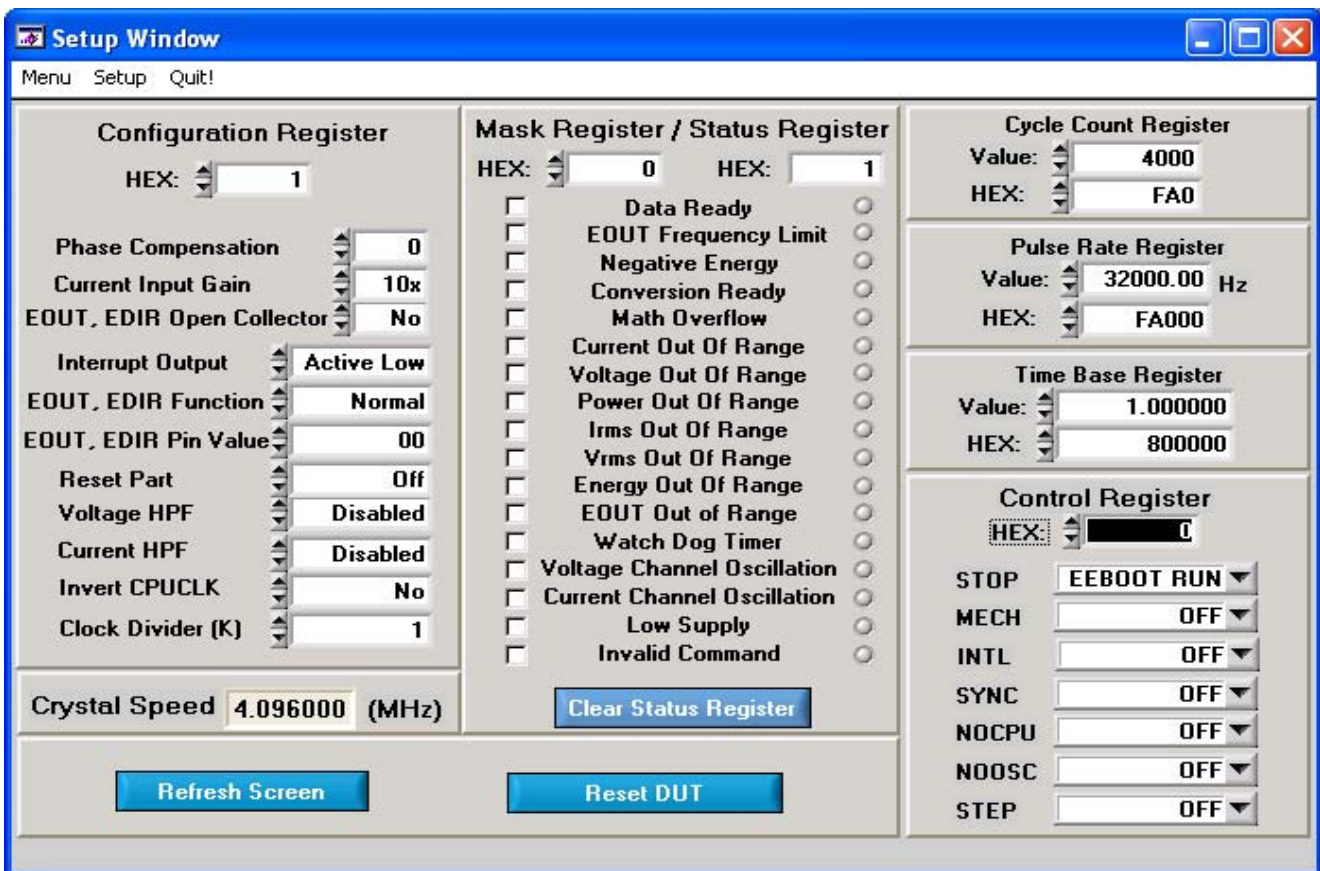

Figure 8. Setup Window

2.4.1 Refresh Screen Button

The *Refresh Screen* button will update the contents of the screen by reading all the register values from the CS5460A. It is a good idea to press the *Refresh Screen* button when entering the *Setup* window, or after modifying any registers, to reflect the current status of the CS5460A.

2.4.2 Reset DUT Button

The *Reset DUT* button will hardware reset the CS5460A. The CS5460A will perform a reset as discussed in the CS5460A data sheet. After the hardware reset to the CS5460A device, the screen contents will be automatically refreshed with the updated status of the CS5460A.

2.4.3 CS5460A Crystal Frequency

The CS5460A accepts a wide range of crystal input frequencies, and can therefore run at many different sample rates. The crystal frequency being used on the CS5460A should be entered in this box to provide accurate frequency calculation in the *FFT* window. This will also help the software decide which functions the evaluation system can perform reliably.

2.4.4 Configuration Register

In the *Configuration Register* box, the contents of the Config register can be modified by typing a hexadecimal value in the *HEX:* field, or by changing any of the values below the *HEX:* field to the desired settings. Although the CDB5460AU software allows the user to modify any of the bits in the Config register, changing certain bits may cause the software and board to behave erratically. For the evaluation system to function properly, the *Interrupt Output* field should be set to the default *Active Low*. This applies only to the CDB5460AU evaluation system, and not to the CS5460A chip itself.

2.4.5 Mask Register / Status Register

The *Mask Register / Status Register* box displays the values for these registers in hexadecimal and decodes them to indicate each bit's function. The Mask register can be modified by typing a value in the *HEX:* field, or by checking the appropriate check boxes for the bits that are to be masked. The Status register cannot be directly modified. It can only be reset by pressing the *Clear Status Register* button. The *HEX:* field for this register and the lamps are indicators only. A lamp which is on means that the corresponding bit in the Status register is set (except the Invalid Command bit, which is inverted). The value present in the Mask register may be changed by the software during certain operations to provide correct functionality of the CDB5460AU board.

2.4.6 Cycle Count / PulseRate / Time Base Registers

These fields display the values of corresponding register in both hexadecimal and decimal format. Each register can be modified by typing a value in the corresponding *Value:* or *HEX:* field.

2.4.7 Control Register

The *Control Register* box is used to make changes to and display the contents of the Ctrl register. The Ctrl register contains various bits used to activate or terminate various features of the CS5460A. Refer to the CS5460A data sheet for descriptions of the bits. The user is able to turn each bit on or off individually. The value of the Ctrl register is displayed in hexadecimal format. Most of the Ctrl register bits are reserved or unused. Only the usable bits are displayed in the Setup Window.

2.5 Calibration Window

The *Calibration* window is used to display and write to the CS5460A offset and gain calibration registers. The user is also able to initiate the CS5460A's calibration sequences that are used to set the calibration values. Both AC and DC calibrations can be run for offset and gain, for either the voltage channel or the current channel, or both simultaneously. The user should refer to the CS5460A data sheet for more details on calibration.

The *Refresh Screen* button will update the contents of the screen by reading all the register values from the part. It is a good idea to press the *Refresh Screen* button when entering the *Calibration* window, or after modifying any registers to reflect the current status of the CS5460A.

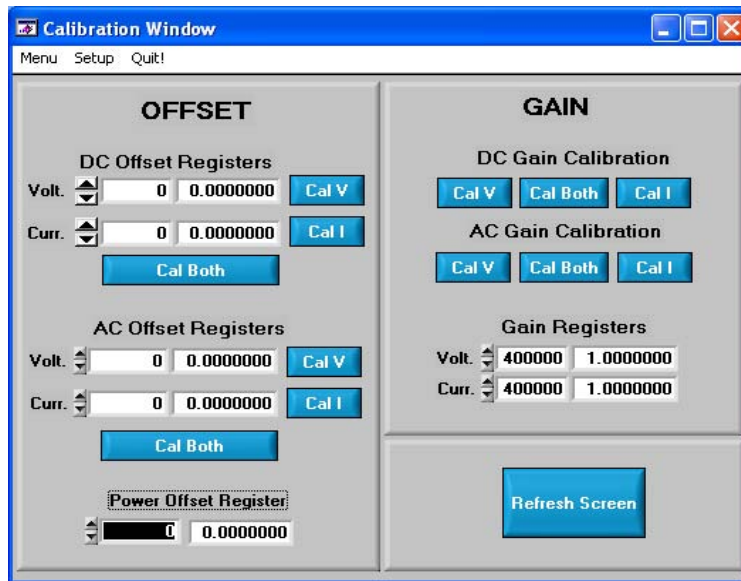

Figure 9. Calibration Window

2.5.1 Offset / Gain Register

In the *Offset* and *Gain* boxes, the offset and gain registers for all channels are displayed in hexadecimal and decimal. These registers can be modified directly by typing the desired value in the hexadecimal display boxes. There are two types of offset registers: DC offset and AC offset. The AC offset registers only affect the RMS register values. The power offset registers only affect the active power register values. The offset register is a two's complement number whose value ranges from -1 to +1. The gain register value ranges from 0 to 4.

2.5.2 Performing Calibrations

Offset and gain calibrations can be performed on both the voltage and current channels of the CS5460A. Because the initial values in the calibration registers will affect the results of the calibrations, it is generally a good idea to software reset the CS5460A before running calibrations. A software reset will reset these registers back to the default values of zero offset and unity gain. Offset calibration should be performed before gain calibration to ensure accurate results.

2.5.2.1 Offset Calibrations

1. Ground the channel(s) you want to calibrate directly at the channel header(s), J17 and J22 for the voltage channel, J24 and J26 for current channel. The channel(s) could also be grounded directly at the screw-type terminals.
2. Press the corresponding AC or DC offset calibrate button (*Cal V*, *Cal I*, or *Cal Both*) beside or below the offset register fields.
3. The calibration value(s) will automatically update when the calibration is completed.

2.5.2.2 Gain Calibrations

1. Attach an AC or DC calibration signal to the screw-type terminals, and make sure the corresponding channel headers (J17, J22, J24, and J26) are set to the input position.
2. Press the corresponding AC or DC gain calibrate button (*Cal V*, *Cal I*, or *Cal Both*) beside or below the gain register fields.
3. The calibration value(s) will automatically update when the calibration is completed.

The *Calibration* window also contains the *Power Offset Register* display and adjustment. The user can read and write the values in the Power Offset register (Poff).

2.6 Conversion Window

The *Conversion* window allows the user to see the results of single and continuous conversions, perform data averaging, and utilize the power-saving modes of the CS5460A. See Figure 10. The *Conversion* window can be accessed from the *Menu* pull-down and selecting *Conversion Window*, or by pressing <F4>.

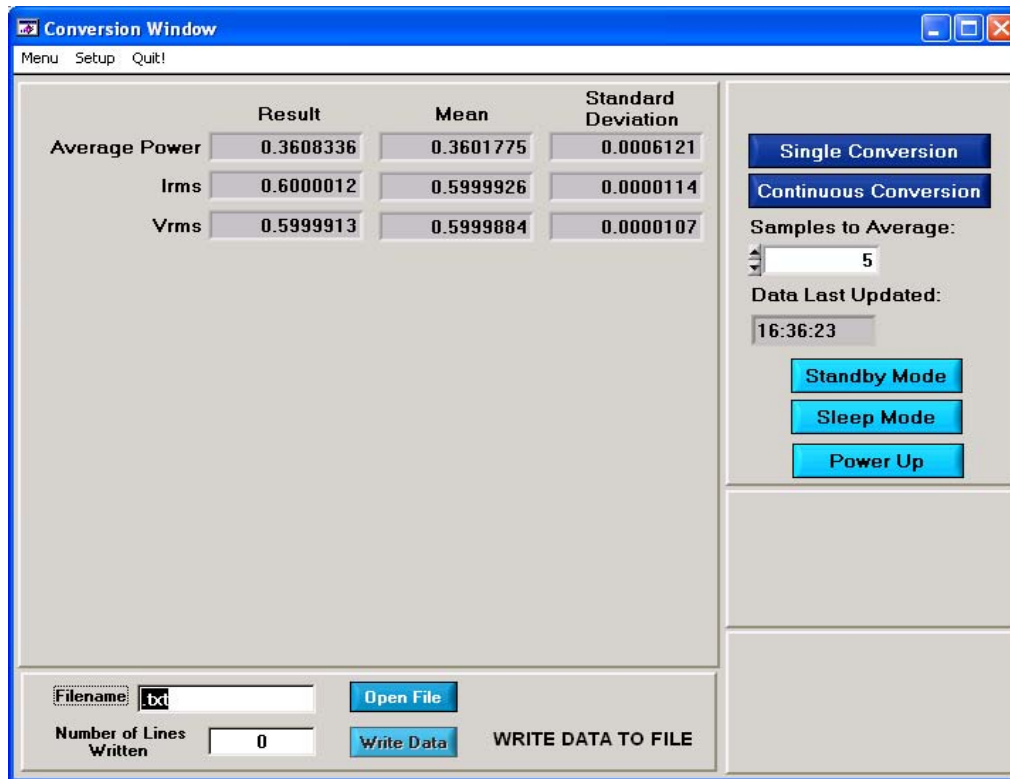

Figure 10. *Conversion Window*

2.6.1 Single Conversion Button

Pressing this button will cause a single conversion to be performed. After a single conversion is complete, the *Result* column will be updated with the values present in each data register.

2.6.2 Continuous Conversion Button

Pressing this button will cause continuous conversions to be performed until the user presses the *Stop* button. After each conversion is complete, the *Result* column will be updated with the values present in each data register. The *Mean* and *Standard Deviation* columns will be updated every N cycles, where N is the number in the *Samples to Average* field. If the *Samples to Average* is set to a large number, it may take many collection cycles after pressing the *Stop* button before the data actually stops being collected.

2.6.3 Standby / Sleep Mode Buttons

When these buttons are pressed, the CS5460A will enter either standby or sleep power saving mode. To return to normal mode, press the *Power Up* button.

2.6.4 Power Up Button

This button is used to send the *Power Up/Halt* command to the CS5460A. The part will return to normal operating mode and halt any conversions that are being done at this time.

2.6.5 Write Data to File

This box provides a means to write the conversion result data to a .txt text file for later analysis or print out. The file path and name will be shown in *Filename* field. The *Open File* button is used to open a new or existing .txt text file for data writing. Each time the *Write Data* button is pressed, the result data is written into the file and the *Number of Lines Written* field value will be increased by 1.

2.7 Pulse Rate Output Window

The CS5460A features a pulse-rate energy output. The CDB5460AU has the capability to demonstrate the functionality of this output in the *Pulse Rate Output* window. See Figure 11. The *Pulse Rate Output* window can be accessed by pressing <F5>, or by pulling down the *Menu* menu, and selecting the *Pulse Rate Window* item.

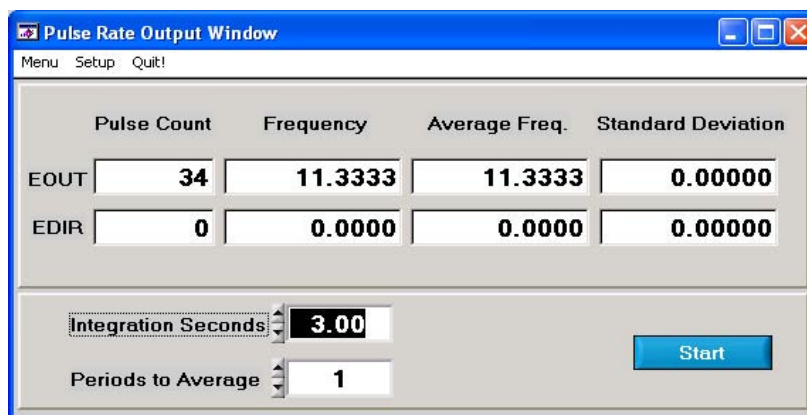

Figure 11. Pulse Rate Output Window

2.7.1 Integration Seconds

This field allows the user to select the length of time over which pulses will be collected.

2.7.2 Periods To Average

This field allows the user to average a number of integration periods.

2.7.3 Start Button

When the *Start* button is pressed, the CDB5460AU will capture pulse rate data according to the values in the *Integration Seconds* and *Periods to Average* fields. After each integration period, the *Pulse Count*, *Frequency* columns will be updated. The *Average Frequency* and *Standard Deviation* columns will only be updated after all the integrations have been collected. The software stops collecting data when the user presses the *Stop* button, or when the data collection is finished. Due to speed limitations of the on-board microcontroller, some higher pulse rates cannot be accurately collected.

2.8 Data Collection Window

The *Data Collection* window (Figure 12) allows the user to collect sample sets of data from the CS5460A and analyze them using time domain, FFT, and histogram plots. The *Data collection* window can be accessed by pulling down the *Menu* menu, and selecting the *Data Collection* window item, or by pressing <F6>.

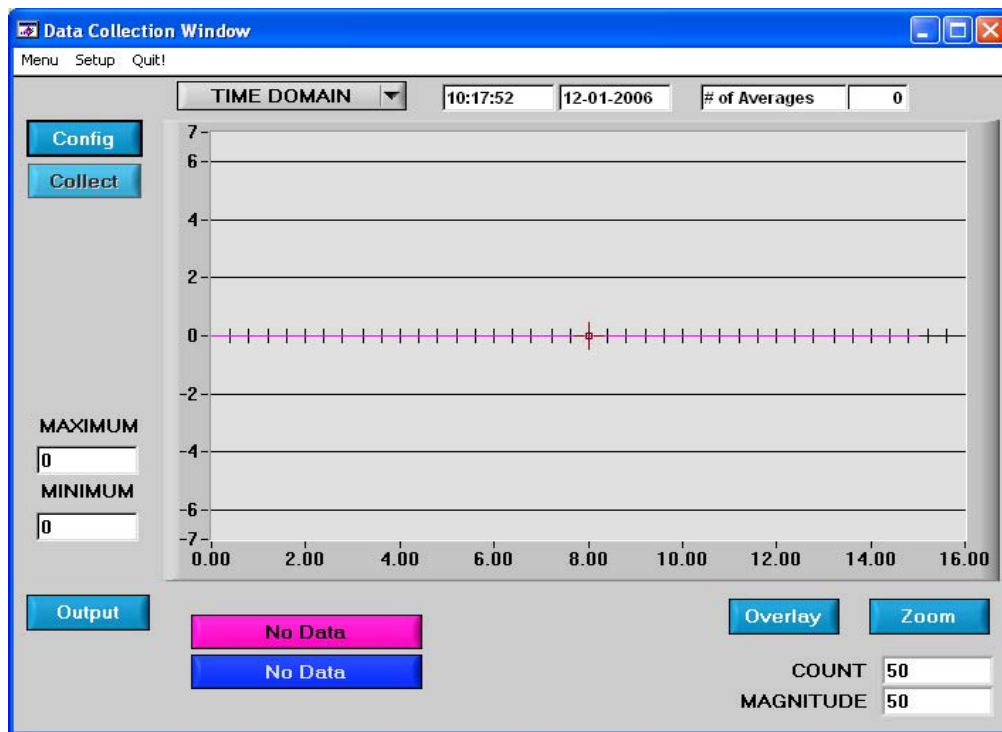

Figure 12. Data Collection Window

2.8.1 Time Domain / FFT/ Histogram Selector

This menu selects the type of data processing to perform on the collected data and display in the plot area. Refer to the Analyzing Data section for more information.

2.8.2 Config Button

This button will bring up the *Configuration* window, in which the user can modify the data collection specifications. Refer to the Configuration Window section in this document for more information.

2.8.3 Collect Button

This button will collect data from the part, to be analyzed in the plot area. See the Collecting Data Sets section for more information.

2.8.4 Output Button

This button will bring up a window in which the user can output the collected data to a file for later use, print out a plot, or print out the entire screen. When saving data, only the data channel being displayed on the plot will be saved to a file.

2.8.5 Zoom Button

This button allows the user to zoom in on the plot by selecting two points in the plot area. Press the *Restore* button to return to the normal data plot, or press the *Zoom* button again to zoom in even further.

2.8.6 Channel Select Button

After data collection, the two buttons labeled as “No Data” will be replaced with *Current* and *Voltage* buttons, allowing the user to choose the appropriate channel for display. In the time domain mode, an additional *Overlay* button will be present which allows the user to display all the channels on the same plot.

2.8.7 Configuration Window

The *Configuration* window allows the user to set up the data collection and analysis parameters.

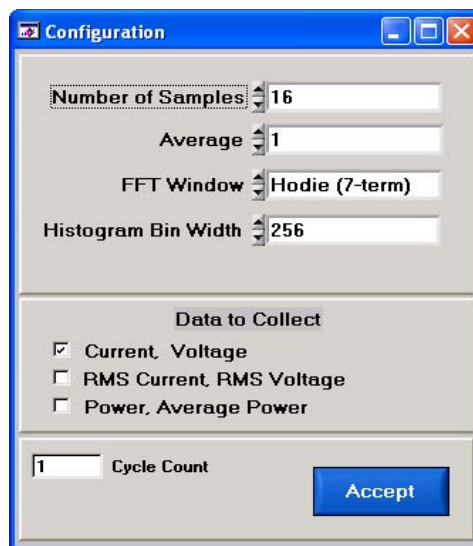

Figure 13. Configuration Window

2.8.7.1 Number of Samples

This field allows the user to select the number of samples to collect, between 16 and 32768.

2.8.7.2 Average

When performing FFT analyses, this field determines the number of FFTs to average. FFTs will be collected and averaged when the *Collect* button is pressed.

2.8.7.3 FFT Window

This field allows the user to select the type of windowing algorithm for FFT processing. Windowing algorithms include the *Blackman*, *Blackman-Harris*, *Hanning*, *5-term Hodie*, and *7-term Hodie*. The 5-term Hodie and 7-term Hodie are windowing algorithms developed at Crystal Semiconductor.

2.8.7.4 Histogram Bin Width

This field determines the "bin width" when plotting histograms of the collected data. Each vertical bar in the histogram plot will contain the number of output codes within a bin range. Decreasing this number may allow the user to view histograms in more detail.

2.8.7.5 Data to Collect

These three check boxes allow the user to select the data types that will be collected and returned to the PC for processing.

2.8.7.6 Cycle Count

The value in the *Cycle Count* field will be written to the Cycle Count register in the CS5460A. The Cycle Count register determines the length of one computation cycle. The *Cycle Count* value should be selected appropriately according to the *Data to Collect* setting. For example, if the *Data to Collect* is instantaneous current, voltage, or power it is better to set *Cycle Count* to 1.

2.8.7.7 Accept Button

When this button is pressed, the current settings will be saved, and the user will return to the *Data Collection* window.

2.8.8 Collecting Data Sets

To collect a sample data set:

1. In the *Data Collection* window, press the *Config* button to bring up the *Configuration* window and view the current settings.
2. Select the appropriate settings from the available options (see the *Configuration Window* section) and press the *Accept* button.
3. The *Data Collection* window should still be visible. Press the *Collect* button to begin collecting data.
4. Once the data has been collected, it can be analyzed, printed, or saved to disk.

2.8.9 Retrieving Saved Data From a File

The CDB5460AU software allows the user to save data to a file, and retrieve it later when needed. To load a previously saved file:

1. Pull down the *Setup* menu and select the *Disk* menu item. A file menu will appear.
2. Find the data file in the list and select it. Press the *Select* button to return.
3. Go to the *Data Collection* window, and press the *Collect* button.
4. The data from the file should appear on the screen. The data will be ready for different types of analysis.
5. To select a different file, repeat the procedure.

2.8.10 Analyzing Data

The evaluation software provides three types of analysis tests: *Time Domain*, *Frequency Domain*, and *Histogram*. The time domain analysis processes acquired conversions to produce a plot of magnitude versus conversion sample number. The frequency domain analysis processes acquired conversions to produce a plot of magnitude versus frequency using the Fast-Fourier transform (results up to $F_s/2$ are calculated and plotted). The histogram analysis processes acquired conversions to produce a histogram plot. Statistical noise calculations are also calculated and displayed.

2.8.11 Histogram Information

The following is a description of the indicators associated with histogram analysis. Histograms can be plotted in the *Data Collection* window by setting the analysis type pull-down menu to *Histogram*.

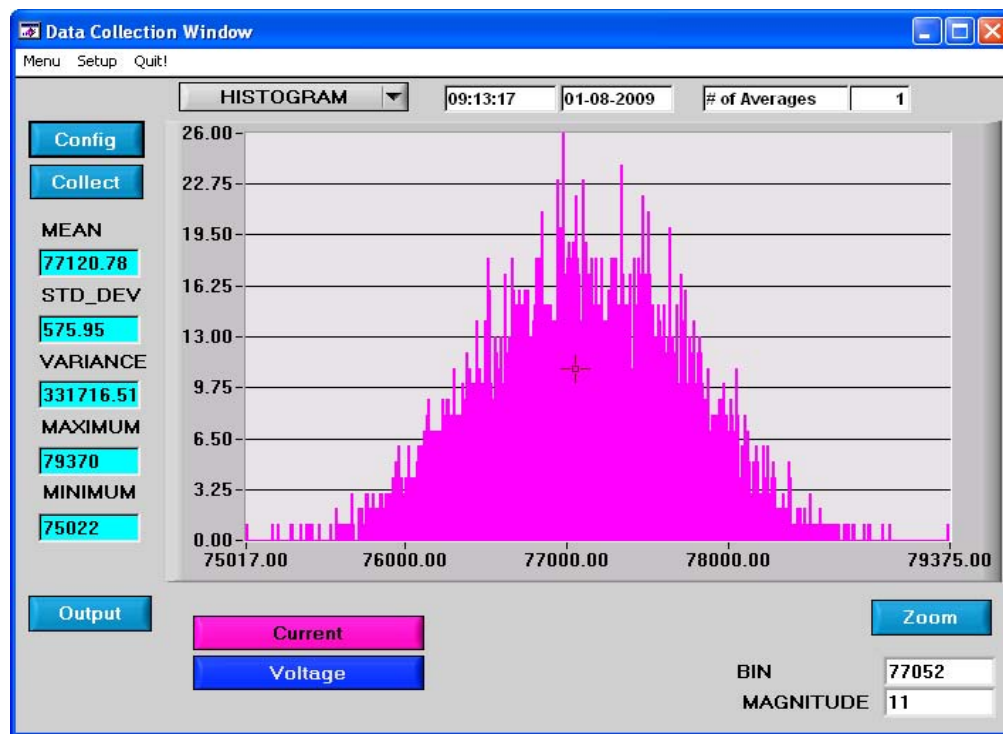

Figure 14. Histogram Analysis

2.8.11.1 BIN

Displays the x-axis value of the cursor on the histogram.

2.8.11.2 MAGNITUDE

Displays the y-axis value of the cursor on the histogram.

2.8.11.3 MEAN

Indicates the mean of the data sample set. The mean is calculated using the following formula:

$$\text{Mean} = \frac{\sum_{i=0}^{n-1} X_i}{n}$$

2.8.11.4 STD_DEV

Indicates the standard deviation of the collected data set. The standard deviation is calculated using the following formula:

$$\text{STDDEV} = \sqrt{\frac{\sum_{i=0}^{n-1} (X_i - \text{MEAN})^2}{n}}$$

2.8.11.5 VARIANCE

Indicates for the variance of the current data set. The variance is calculated using the following formula:

$$\text{VARIANCE} = \frac{\sum_{i=0}^{n-1} (X_i - \text{MEAN})^2}{n}$$

2.8.11.6 MAXIMUM

Indicates the maximum value of the collected data set.

2.8.11.7 MINIMUM

Indicates the minimum value of the collected data set.

2.8.12 Frequency Domain Information

The following describe the indicators associated with FFT (Fast Fourier Transform) analysis. FFT data can be plotted in the *Data Collection* window by setting the analysis type selector to *FFT*.

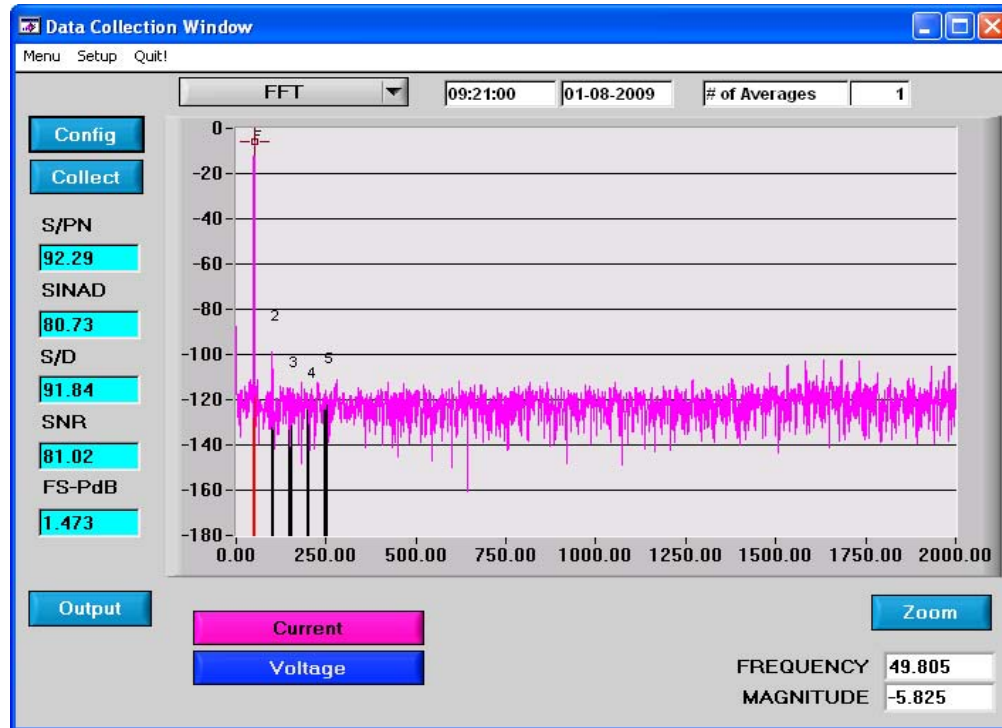

Figure 15. FFT Analysis

2.8.12.1 FREQUENCY

Displays the x-axis value of the cursor on the FFT display.

2.8.12.2 MAGNITUDE

Displays the y-axis value of the cursor on the FFT display.

2.8.12.3 S/PN

Indicates the signal-to-peak noise ratio (decibels).

2.8.12.4 SINAD

Indicates for the signal-plus-noise-plus-distortion to noise-plus-distortion ratio (decibels).

2.8.12.5 S/D

Indicates for the signal-to-distortion ratio, 4 harmonics are used in the calculations (decibels).

2.8.12.6 SNR

Indicates for the signal-to-noise ratio, first 4 harmonics are not included (decibels).

2.8.12.7 FS-Pdb

Indicates for the full-scale to signal Ratio (decibels).

2.8.12.8 Time Domain Information

The following controls and indicators are associated with time domain analysis. Time domain data can be plotted in the *Data Collection* window by setting the analysis type selector to *Time Domain*.

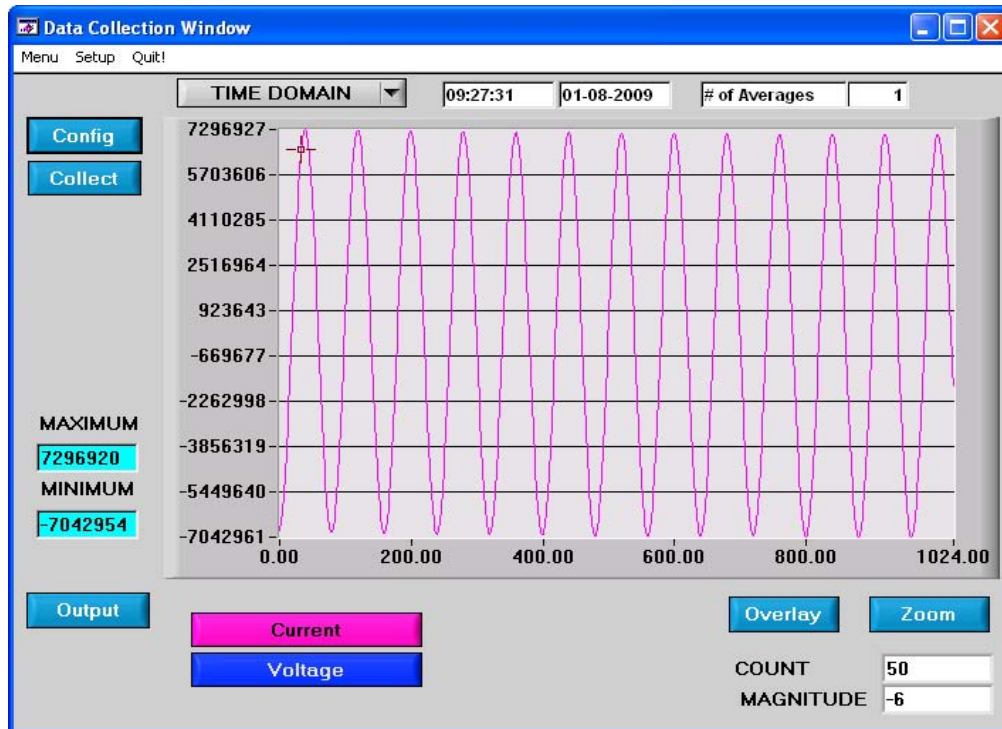

Figure 16. Time Domain Analysis

2.8.12.9 COUNT

Displays current x-position of the cursor on the time domain display.

2.8.12.10 MAGNITUDE

Displays current y-position of the cursor on the time domain display.

2.8.12.11 MAXIMUM

Indicates for the maximum value of the collected data set.

2.8.12.12 MINIMUM

Indicates for the minimum value of the collected data set.

2.9 EEPROM Window

CDB5460AU has an "Auto-Boot" demo feature that uses the on-board serial EEPROM, so that the CDB5460AU can operate independently without being connected to a PC. CDB5460AU GUI software also provides an EEPROM window for reading & writing the serial EEPROM.

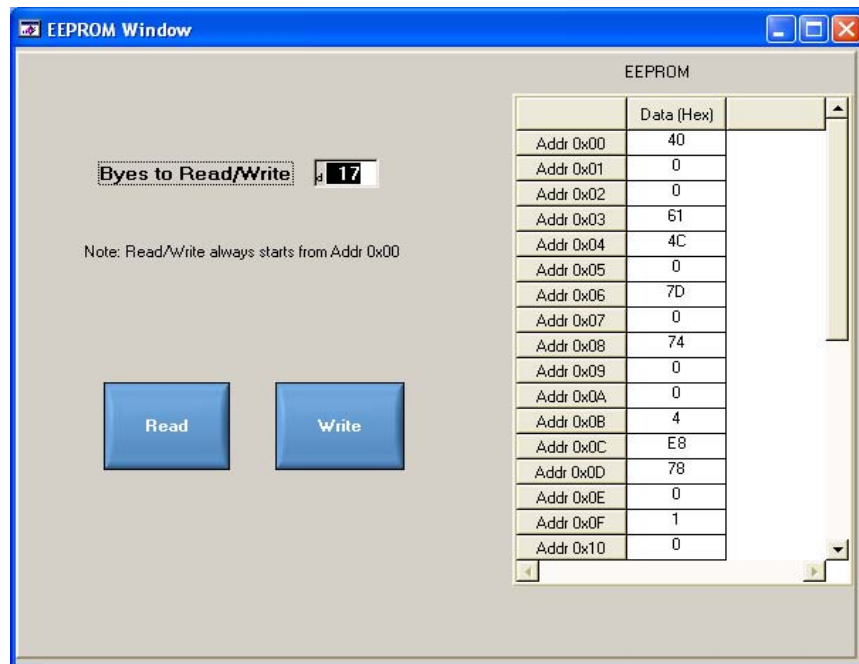

Figure 17. EEPROM Window

2.9.1 Bytes to Read/Write

The *Bytes to Read/Write* field allows the user to define the number of bytes to read or write.

2.9.2 Read EEPROM

First input the number of bytes to read in the *Bytes to Read/Write* field. After pressing the *Read* button, that number of bytes starting from the address 0x00 will be read from EEPROM and displayed in the *EEPROM* table in hexadecimal format.

2.9.3 Write EEPROM

Input the number of bytes to write in the *Bytes to Read/Write* field and input the hexadecimal byte values in the EEPROM table starting from address 0x00. After pressing the *Write* button, the bytes in the *EEPROM* table will be written to the EEPROM.

2.10 Debug Panel

The *Debug* panel provides the user a way to access CS5460A registers and send commands to CS5460A directly. See Figure 18. Refer to section 4.1 in the CS5460A data sheet for more detailed information about the commands and registers.

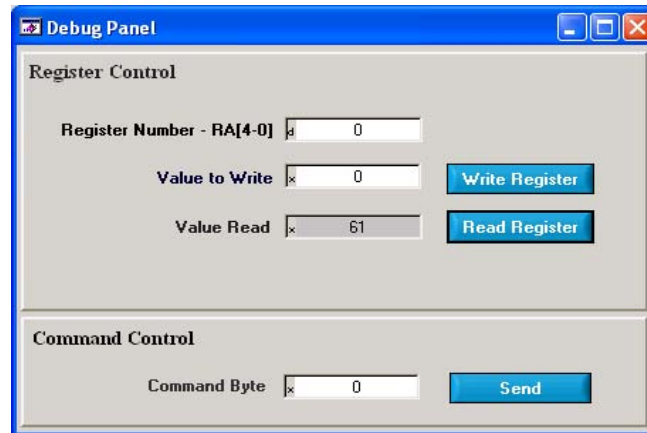

Figure 18. Debug Panel

APPENDIX A. BILL OF MATERIALS
BILL OF MATERIAL (Page 1 of 2)
CIRRUS LOGIC
CDB5460AU_Rev_B.bom

Item	Cirrus P/N	Rev	Description	Qty	Reference Designator	MFG	MFG P/N	Notes
1	001-06872-Z1	A	CAP 0.1uF ±10% 50V NPb X7R 1206	6	C1 C18 C19 C21 C29 C30	KEMET	C1206C104KGRAC	
2	001-02779-Z1	A	CAP 22pF ±5% 50V COG NPb 0805	1	C2	KEMET	C0805C220J5GAC	
3	001-02189-Z1	A	CAP 0.1uF ±10% 16V X7R NPb 0603	5	C3 C4 C26 C32 C33	KEMET	C0603C104K4RAC	
4	012-00010-Z1	A	CAP 47uF ±20% 16V NPb ELEC CASE C	4	C5 C8 C28 C31	PANASONIC	EEE1CA470WR	
5	001-04344-Z1	A	CAP 0.1uF ±5% 50V X7R NPb 0805	7	C6 C7 C10 C11 C12 C15 C25	KEMET	C0805C104J5RAC	
6	001-03266-Z1	A	CAP 220pF ±10% 50V X7R NPb 0805	4	C9 C17 C20 C24	KEMET	C0805C221K5RAC	
7	001-06685-Z1	A	CAP 0.018uF ±10% 50V X7R NPb 1206	2	C13 C23	KEMET	C1206C183K6RAC	
8	012-00012-Z1	A	CAP 10uF ±20% 16V ELEC NPb CASE A	3	C14 C22 C1000	PANASONIC	EEE1CS100SR	
9	001-07078-Z1	A	CAP 1uF ±10% 25V X7R NPb 1206	1	C16	KEMET	C1206C106K3RAC	
10	070-00005-Z1	A	DIODE ARRAY 5V (TVS) ESD NPb SOT143	1	D1	LITTELFUSE	SP0503BAHTG	
11	165-00004-Z1	A	LED SUP RED 1.7V 1ma 1.6MCD NPb SMD	6	D2 D3 D4 D5 D6 D7	CHICAGO MINIATURE	GMD28-21SRC/TRR8T1	
12	115-00003-Z1	A	HDR 5x2 ML 1"CTR S GLD NPb	1	J1	SAMTEC	TSW-105-07-G-D	
13	110-00041-Z1	A	CON RA USB BLK NPb TH	1	J2	AMP	292304-1	
14	110-00010-Z1	A	CON BPOST 2" SILV NYLON INS RED NPb	3	J3 J5 J6	JOHNSON COMPONENTS	111-0102-001	REQUIRES WIRE 1.5L X 0.25T X 0.25T TYPE E 24/19 BLU SQUIRES ELEC. INC.
15	110-00008-Z1	A	CON BPOST 2" SILV NYLON INS BLK NPb	1	J4	JOHNSON COMPONENTS	111-0103-001	REQUIRES WIRE 1.5L X 0.25T X 0.25T TYPE E 24/19 BLU SQUIRES ELEC. INC.
16	115-00016-Z1	A	HDR 3x2 ML 1"CTR 062 S GLD NPb	6	J8 J9 J17 J22 J24 J26	SAMTEC	TSW-103-07-G-D	
17	115-00014-Z1	A	HDR 2x1 ML 1" 062BD ST GLD NPb TH	5	J10 J13 J15 J16 J18	SAMTEC	TSW-102-07-G-S	
18	115-00013-Z1	A	HDR 2x2 ML 1"CTR 062BD S GLD NPb	1	J12	SAMTEC	TSW-102-07-G-D	
19	110-00056-Z1	A	CON TERM BLOCK 2POS 5mm NPb BLU TH	1	J14	ON-SHORE TECHNOLOGY	ED 100/2DS	
20	110-00055-Z1	A	CON TERM BLOCK 4 POS 5mm NPb BLU TH	2	J23 J27	ON-SHORE TECHNOLOGY	ED 100/4DS	
21	115-00009-Z1	A	HDR 3x1 ML 1" 062 ST GLD NPb TH	1	J25	SAMTEC	TSW-103-07-G-S	
22	115-00031-Z1	A	HDR 11x2 ML 1"CTR 062 S GLD NPb	1	J40	SAMTEC	TSW-111-07-G-D	
23	080-00004-Z1	A	WIRE JUMPER 2P 0.1" BRASS NPb TH	6	JP1 JP2 JP3 JP4 JP5 JP6	COMPONENTS CORPORATION	TP-101-10	
24	304-00001-Z1	A	SPCR STANDOFF 4-40 THR. 875L AL NPb	4	MH1 MH2 MH3 MH4	KEYSTONE	1809	REQUIRES 4-40- PAN HEAD SCREW
25	020-01848-Z1	A	RES 2k OHM 1/8W ±1% NPb 0805 FILM	12	R2 R3 R6 R7 R8 R14 R15 R16 R17 R29 R36	DALE	CRCW08052K00FKEA	
26	020-01588-Z1	A	RES 10 OHM 1/8W ±1% NPb 0805 FILM	1	R4	DALE	CRCW080510R0FKEA	
27	020-01816-Z1	A	RES 1k OHM 1/8W ±1% NPb 0805 FILM	5	R5 R11 R12 R13 R18	DALE	CRCW08051K00FKEA	
28	020-01930-Z1	A	RES 10k OHM 1/8W ±1% NPb 0805 FILM	0	R19	DALE	CRCW080510K0FKEA	DO NOT POPULATE
29	035-00005-Z1	A	RES POT 5k ±10% 25TURN TRIM NPb TH	0	R20	BOURNS	3296W-1-502LF	DO NOT POPULATE
30	020-01667-Z1	A	RES 49.9 OHM 1/8W ±1% NPb 0805 FILM	1	R21	DALE	CRCW0805499RKEA	
31	020-01905-Z1	A	RES 6.04k OHM 1/8W ±1% NPb 0805 FILM	0	R22	DALE	CRCW08056K04FKEA	DO NOT POPULATE
32	021-00759-Z1	A	RES 1k OHM 1/3W ±5% NPb 1210 FILM	4	R23 R24 R26 R28	DALE	CRCW12101K00JNEA	

BILL OF MATERIAL (Page 2 of 2)
**CIRRUS LOGIC
CDB5460AU_Rev_B.bom**

Item	Cirrus P/N	Rev	Description	Qty	Reference Designator	MFG	MFG P/N	Notes
33	020-03355-Z1	A	RES 30T OHM 1/3W ±1% NPb 1210 FILM	1	R25	DALE	CRCW1210301RKFKEA	
34	020-03378-Z1	A	RES 470 OHM 1/3W ±1% NPb 1210 FILM	4	R30 R31 R32 R33	DALE	CRCW1210470RKFKEA	
35	020-03539-Z1	A	RES 12.1k OHM 1/3W ±1% NPb 1210 FILM	1	R35	DALE	CRCW121012K1FKFA	
36	020-02748-Z1	A	RES 15k OHM 1/4W ±1% 1206 NPb FILM	1	R37	DALE	CRCW120615K0FKFA	
37	020-01473-Z1	A	RES 0 OHM 1/18W ±1% NPb 0805 FILM	12	R51 R52 R53 R54 R55 R56 R57 R58 R59 R60 R61 R62	DALE	CRCW08050000Z0EA	
38	020-02273-Z1	A	RES 0 OHM 1/4W NPb 1206 FILM	1	R64	DALE	CRCW12060000Z0EA	
39	120-00002-Z1	A	SWT SPST 130G 0.1 5mm TACT ESD NPb	1	S1	ITT INDUSTRIES	PT5645TL50	INSTALL AFTER WASH PROCESS
40	110-00045-Z1	A	CON TEST PT .1"CTR TIN PLAT NPb BLK	16	TP1 TP2 TP9 TP10 TP11 TP12 TP13 TP20 TP21 TP22 TP23 TP24 TP25 TP26 TP27 TP30	KEYSTONE	5001	
41	062-00124-Z1	A	IC PGM 128BIT SER EPROM NPb SOT23-5	1	U1	MICROCHIP	24LC00-IOT	PROGRAM AT TEST
42	061-00250-Z1	A	IC DIG LOW V BUFLDRV 5V NPb SOIC20	1	U2	FAIRCHILD SEMICONDUCTOR	74LCX760WMX	
43	062-00079-Z1	A	IC PGM USB 16Mb FLAS MCU NPb LQFP32	1	U3	SILICON LABORATORIES INC	C8051F320-GQ	PROGRAM AT TEST
44	060-00061-Z1	A	IC LNR PREC V REF 2.5V NPb SO8	1	U4	FAIRCHILD	LT1019CS8-2.5#PBF	
45	061-00190-Z1	A	IC LOG UHS TINY DUAL BUF NPb SC70-6	1	U5	LINEAR TECH SEMICONDUCTOR	NC7WZ07P6X	
46	065-00161-Z2	C	IC CRUIS PWM/ENERGY IC NPb SSOP24	1	U6	CIRRUS LOGIC	CS5460A-BSZC	
47	061-00002-Z1	A	IC LOG INV 5P UHS TINY NPb SOT23	1	U8	FAIRCHILD SEMICONDUCTOR	NC7SZ04M5X	
48	061-00219-Z1	A	IC LOG UHS TINY ANA SVT 6P NPb SC70	2	U9 U11	FAIRCHILD SEMICONDUCTOR	NC7SB3157P6X	
49	062-00122-Z1	A	IC PGM EEPROM 512x8 SPI NPb SOIC8	1	U10	ATMEL	AT25040AN-10SU-2.7	PROGRAM AT TEST
50	080-00003-Z1	A	WIRE BPOST 1.5X.25 24/19 GA BLU NPb	4	XJ3 XJ4 XJ5 XJ6	SQUIRES	L-1.5X.25TX.25T TYPE E	WIRES FOR BINDING POSTS
51	300-00025-Z1	A	SCREW 4-40X5/16" PH MACH SS NPb	4	XMH1 XMH2 XMH3 XMH4	BUILDING FASTENERS	PMSS 440 0031 PH	SCREWS FOR STANDOFFS
52	135-00013-01	A	SKT PINCH CONTACT FOR SSOP24	0	XU6	ENPLAS	OTS-24(34)-0.65-01	DO NOT POPULATE
53	100-00049-Z1	A	XTL 4.0960MHZ HC495 50ppm 50pF NPb	1	Y1	CAL CRYSTAL	CCL-6S-4.0960C14F-R	
54	070-00006-Z1	A	DIODE TR 6.8V 6000V NPb AXL	3	Z1 Z2 Z3	LITTELFUSE	PK6E6.8	
55	600-00176-Z2	B	SCHEM CDB5460AU-Z NPb	REF		CIRRUS LOGIC	600-00176-Z2	
56	240-00176-Z1	B	PCB CDB5460A 61A .63 NPb	1		CIRRUS LOGIC	240-00176-Z1	
57	603-00176-01	B	ASSY DWG PWA CDB5460A 61A .63	REF		CIRRUS LOGIC	603-00176-01	
58	110-00013-Z1	D	CON SHUNT 2P .1"CTR BLK NPb	12		MOLEX	15-29-1025	REFER TO ASSEMBLY DRAWING FOR PLACEMENT LOCATIONS
59	422-00037-01	A1	LBL SUBASSY PRODUCT NUMBER	1		CIRRUS LOGIC	422-00037-01	REFER TO ASSEMBLY DRAWING FOR PLACEMENT LOCATION
60	020-01473-Z1	A	RES 0 OHM 1/18W ±1% NPb 0805 FILM	0	R34	DALE	CRCW08050000Z0EA	DO NOT POPULATE
61	110-00045-Z1	A	CON TEST PT .1"CTR TIN PLAT NPb BLK	0	TP7 TP8	KEYSTONE	5001	DO NOT POPULATE
62	312-00068-01	A	INSULATOR .312 x .145 FOR HC4901US	1	X11	ECS	700-9001	INSULATOR FOR Y1

APPENDIX B. SCHEMATICS

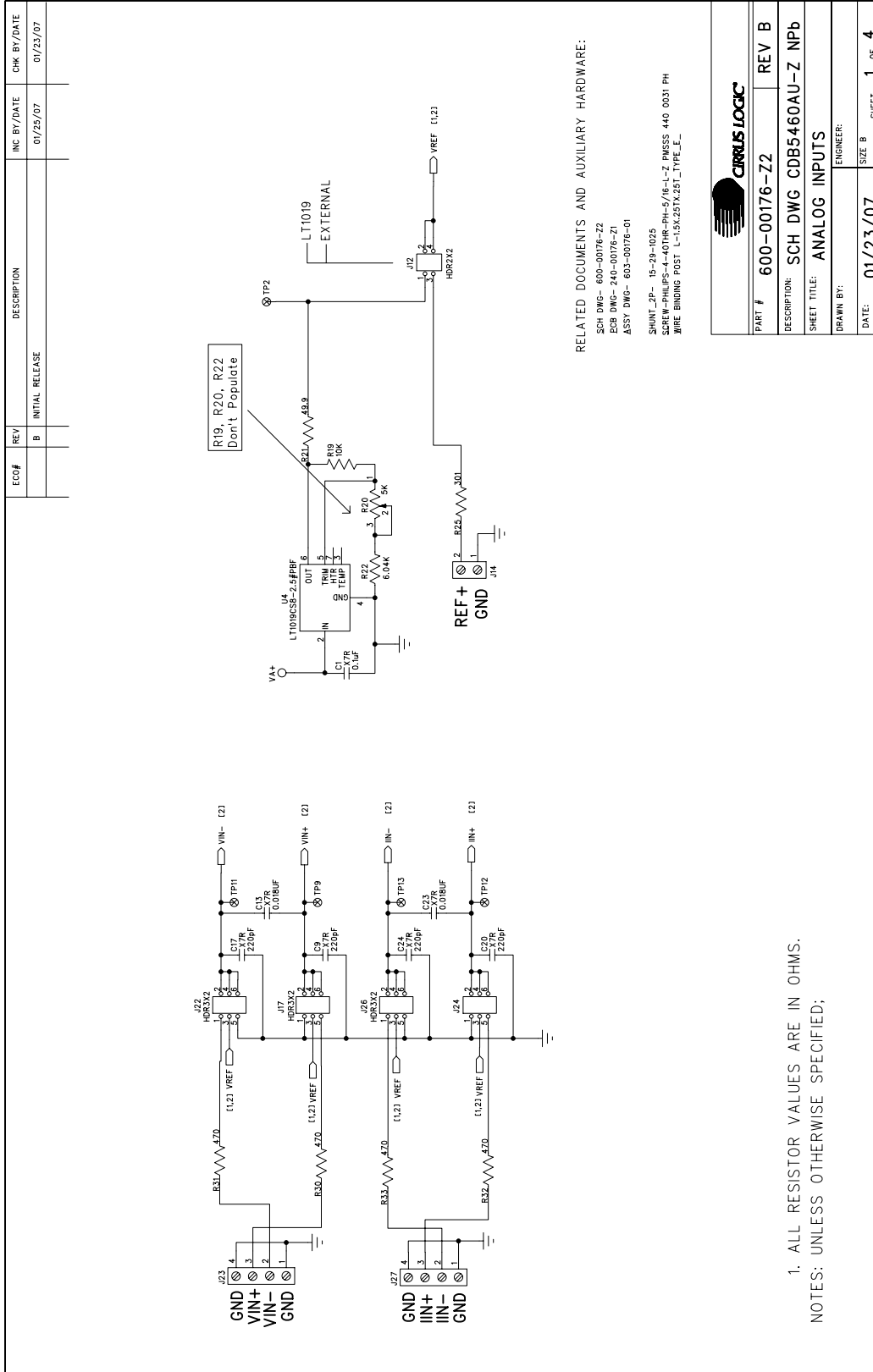

1. ALL RESISTOR VALUES ARE IN OHMS.
 NOTES: UNLESS OTHERWISE SPECIFIED;

Figure 19. Schematic - Analog Inputs

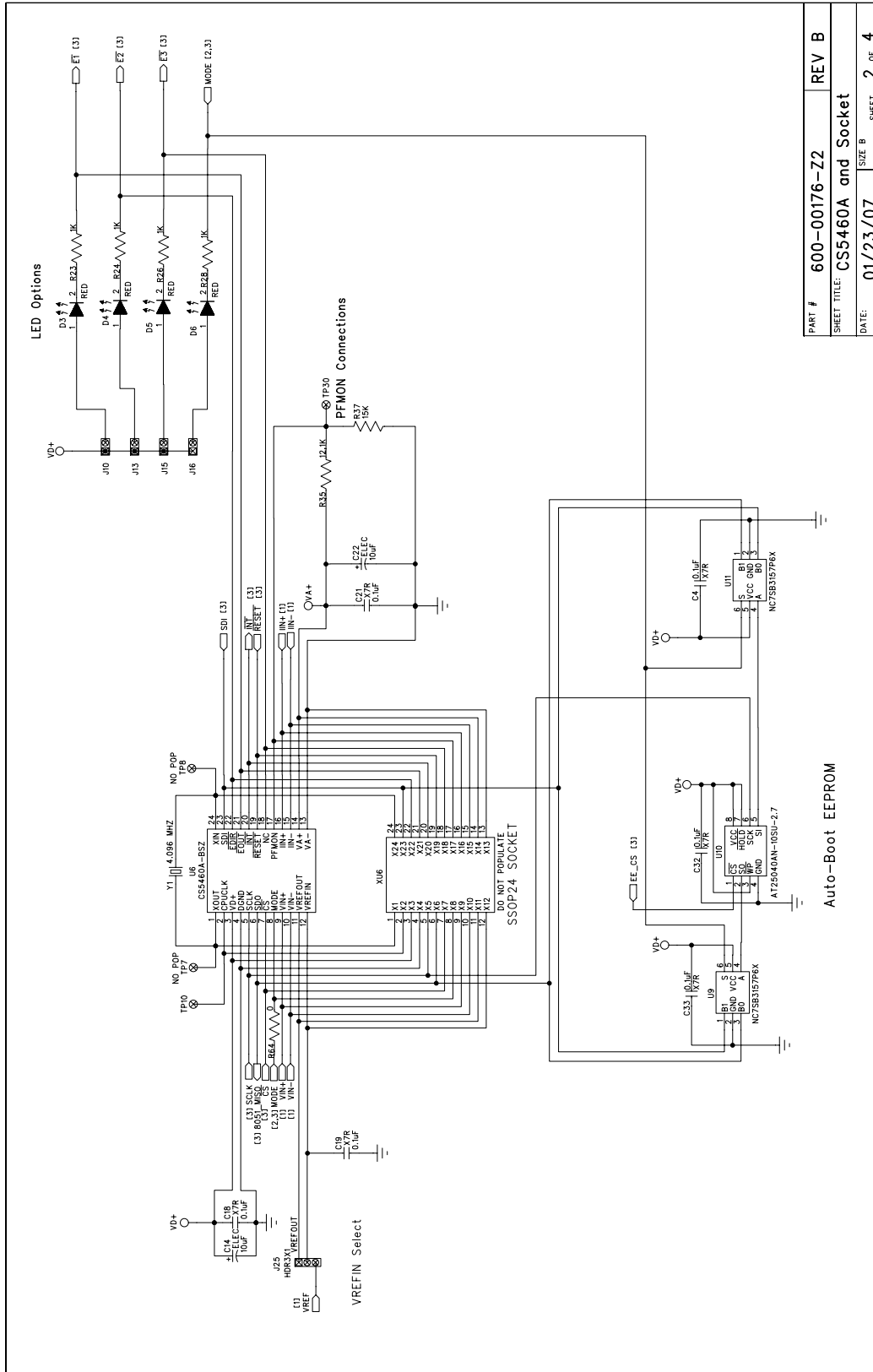

PART #	600-00176-Z2	REV B
SHEET TITLE:	CS5460A and Socket	
DATE:	01/23/07	SHEET 2 OF 4

Figure 20. Schematic - CS5460A & Socket

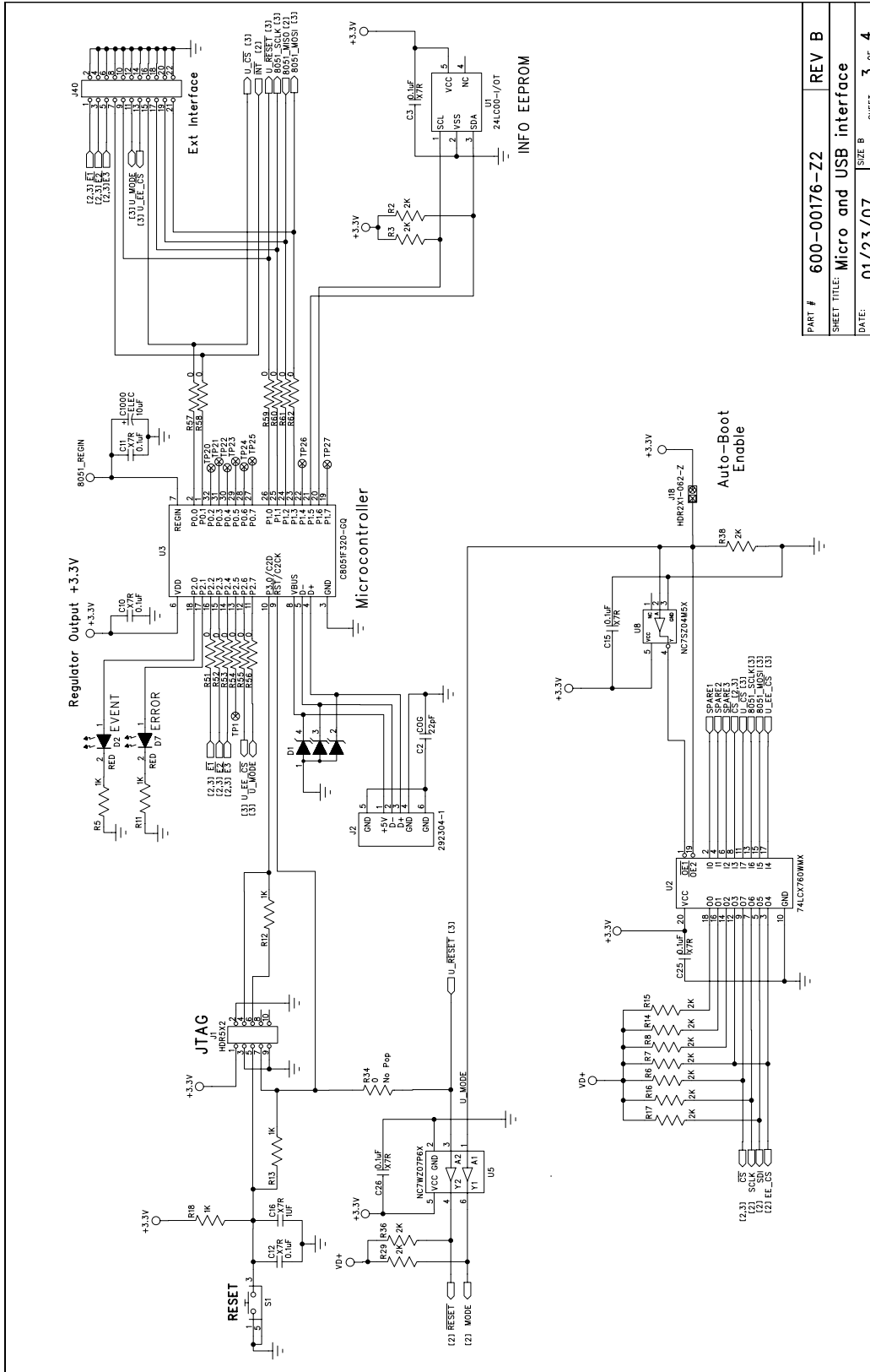

PART #	600-00176-Z2	REV B
SHEET TITLE:	Micro and USB interface	
DATE:	01/23/07	SIZE B SHEET 3 OF 4

Figure 21. Schematic - Microcontroller & USB Interface

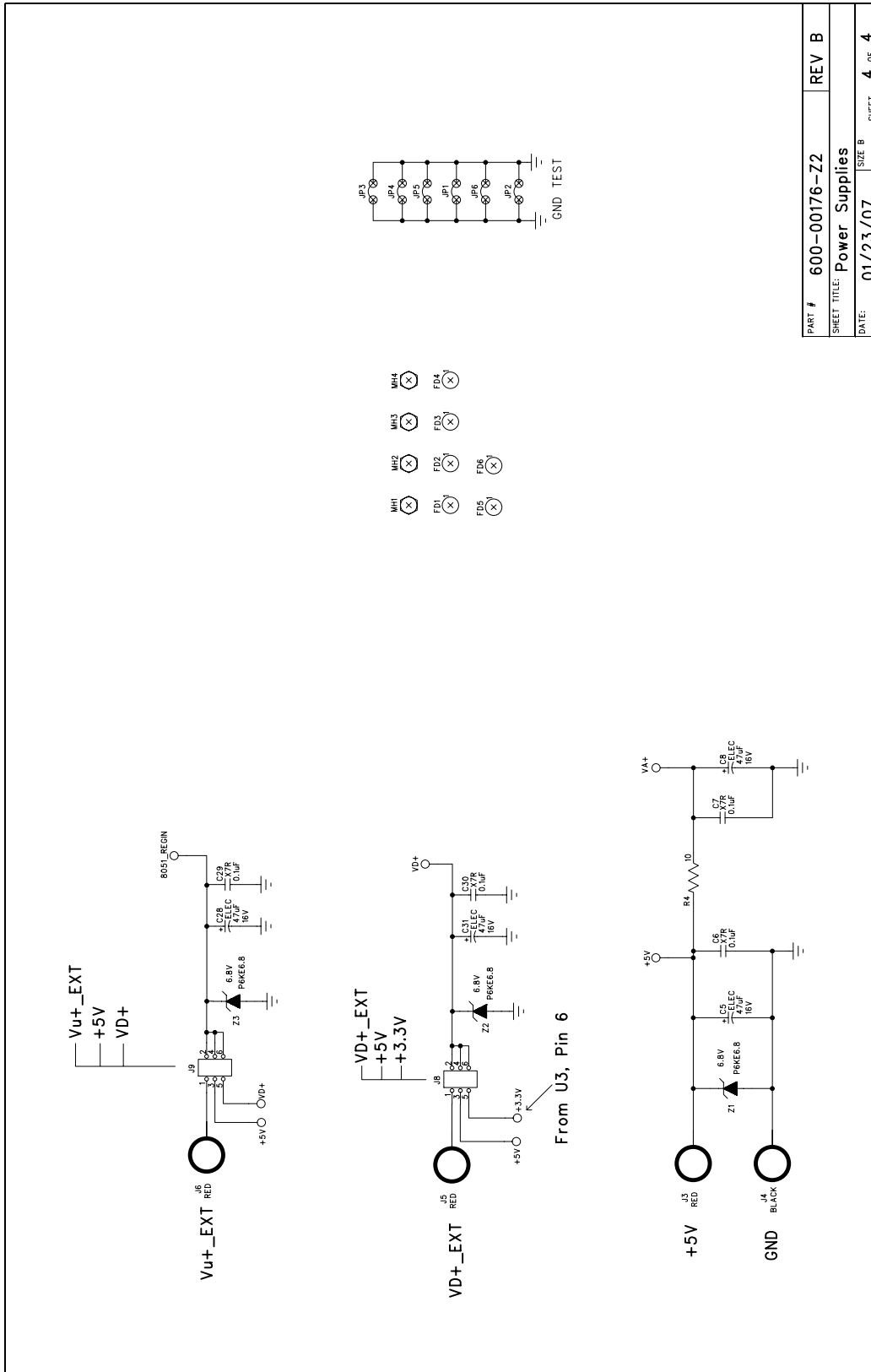
Figure 22. Schematic - Power Supplies

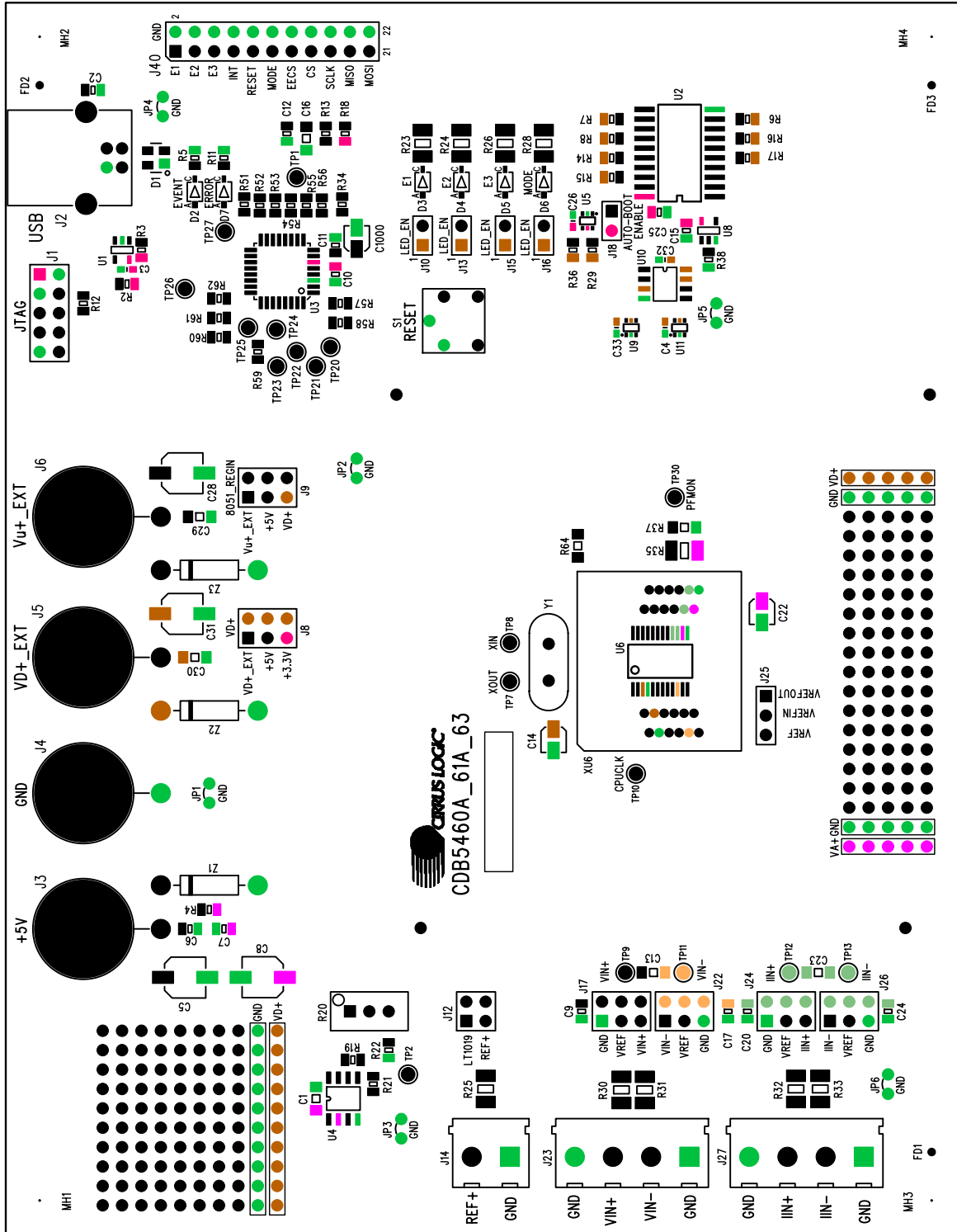
APPENDIX C. LAYER PLOTS

CIRRUS LOGIC PCB-240-00176-Z1 Rev B

Figure 23. Top Silkscreen

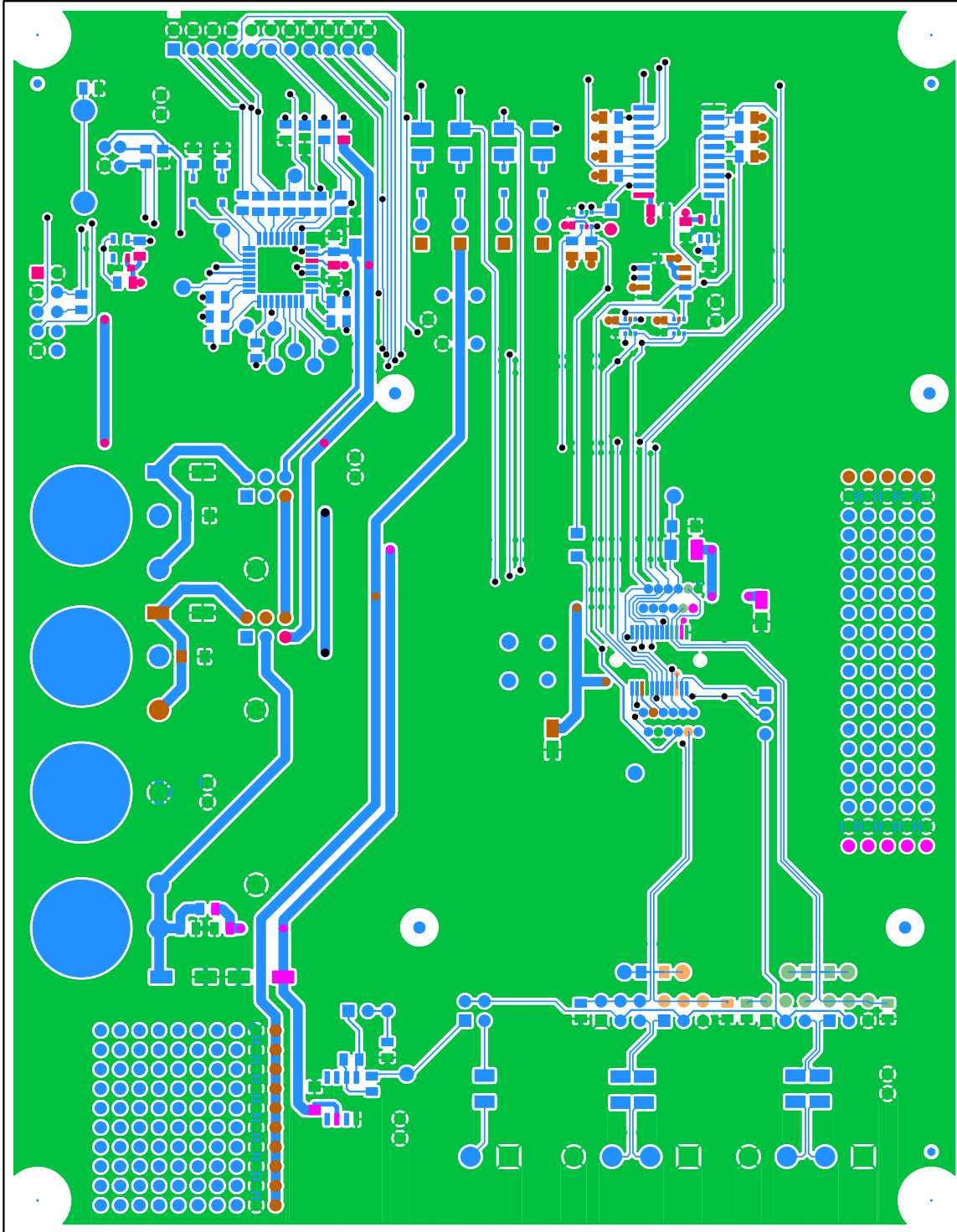

CIRRUS LOGIC PCB-240-00176-Z1 Rev B

TOP SIDE

Figure 24. Top Routing

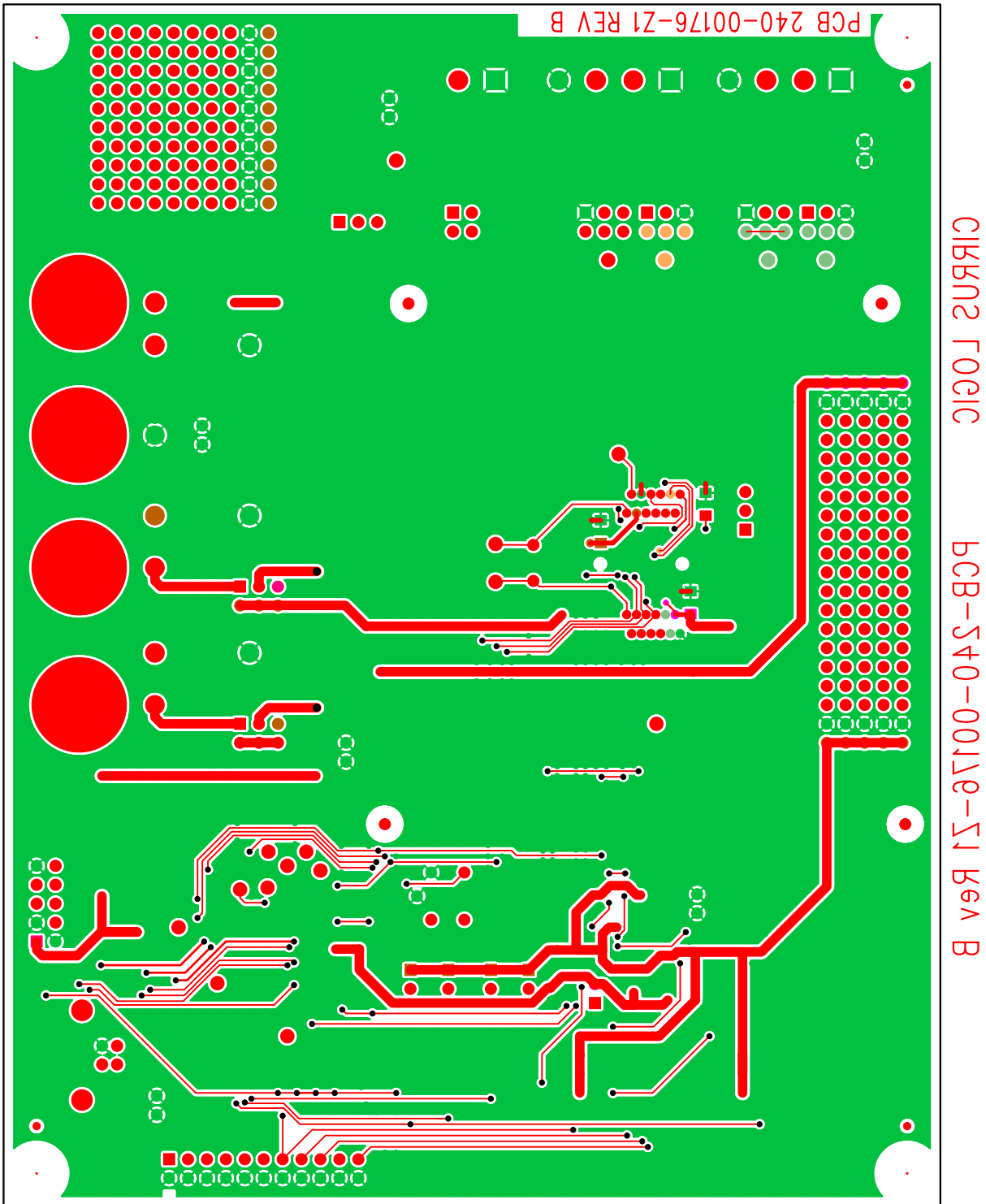
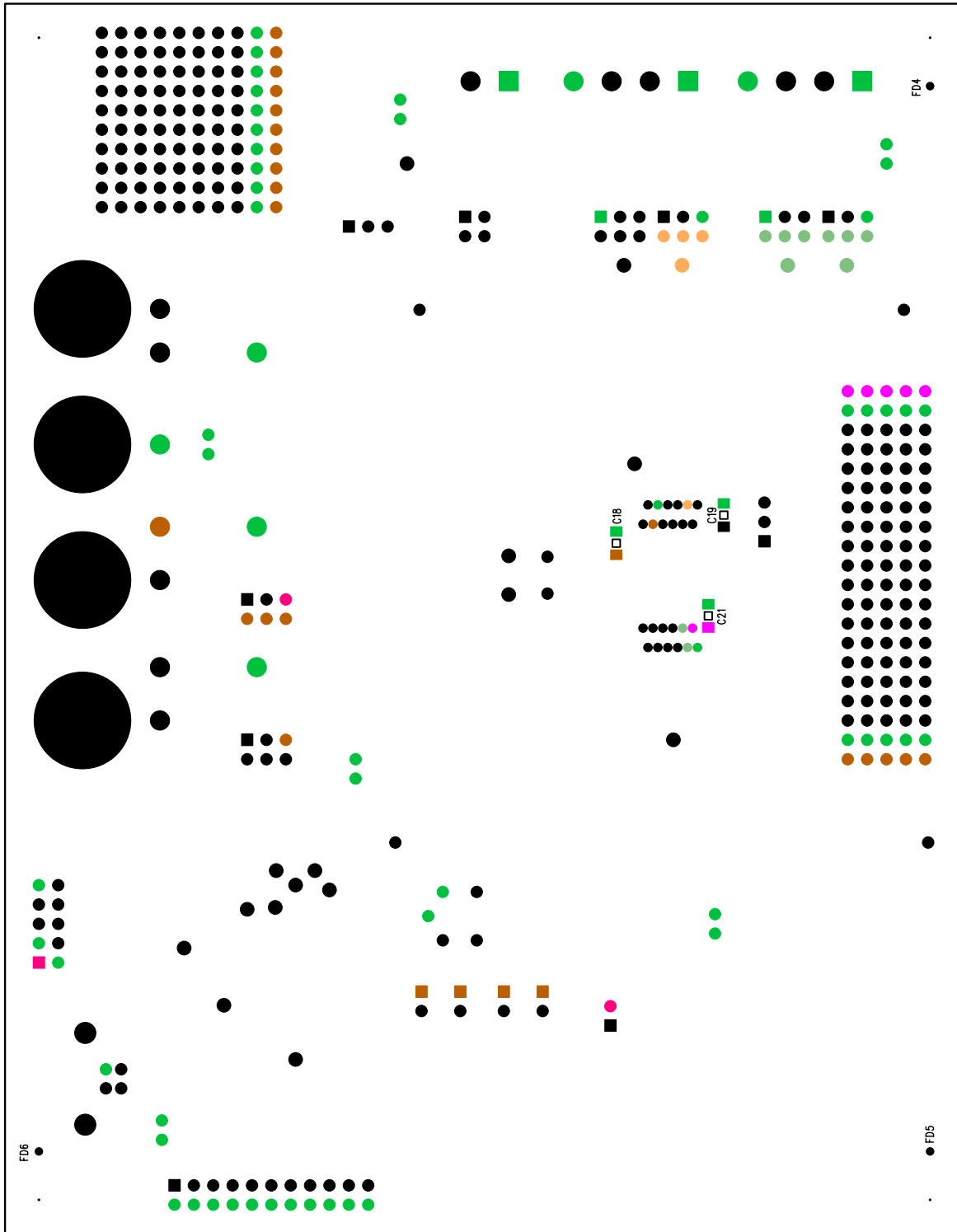

Figure 25. Bottom Routing



CIRRUS LOGIC PCB-540-00119-Σ1 Rev B

Figure 26. Bottom Silkscreen

REVISION HISTORY

Revision	Date	Changes
DB1	JAN 2009	Initial Release.

Contacting Cirrus Logic Support

For all product questions and inquiries contact a Cirrus Logic Sales Representative. To find the one nearest to you go to www.cirrus.com

IMPORTANT NOTICE

Cirrus Logic, Inc. and its subsidiaries ("Cirrus") believe that the information contained in this document is accurate and reliable. However, the information is subject to change without notice and is provided "AS IS" without warranty of any kind (express or implied). Customers are advised to obtain the latest version of relevant information to verify, before placing orders, that information being relied on is current and complete. All products are sold subject to the terms and conditions of sale supplied at the time of order acknowledgment, including those pertaining to warranty, indemnification, and limitation of liability. No responsibility is assumed by Cirrus for the use of this information, including use of this information as the basis for manufacture or sale of any items, or for infringement of patents or other rights of third parties. This document is the property of Cirrus and by furnishing this information, Cirrus grants no license, express or implied under any patents, mask work rights, copyrights, trademarks, trade secrets or other intellectual property rights. Cirrus owns the copyrights associated with the information contained herein and gives consent for copies to be made of the information only for use within your organization with respect to Cirrus integrated circuits or other products of Cirrus. This consent does not extend to other copying such as copying for general distribution, advertising or promotional purposes, or for creating any work for resale.

CERTAIN APPLICATIONS USING SEMICONDUCTOR PRODUCTS MAY INVOLVE POTENTIAL RISKS OF DEATH, PERSONAL INJURY, OR SEVERE PROPERTY OR ENVIRONMENTAL DAMAGE ("CRITICAL APPLICATIONS"). CIRRUS PRODUCTS ARE NOT DESIGNED, AUTHORIZED OR WARRANTED FOR USE IN PRODUCTS SURGICALLY IMPLANTED INTO THE BODY, AUTOMOTIVE SAFETY OR SECURITY DEVICES, LIFE SUPPORT PRODUCTS OR OTHER CRITICAL APPLICATIONS. INCLUSION OF CIRRUS PRODUCTS IN SUCH APPLICATIONS IS UNDERSTOOD TO BE FULLY AT THE CUSTOMER'S RISK AND CIRRUS DISCLAIMS AND MAKES NO WARRANTY, EXPRESS, STATUTORY OR IMPLIED, INCLUDING THE IMPLIED WARRANTIES OF MERCHANTABILITY AND FITNESS FOR PARTICULAR PURPOSE, WITH REGARD TO ANY CIRRUS PRODUCT THAT IS USED IN SUCH A MANNER. IF THE CUSTOMER OR CUSTOMER'S CUSTOMER USES OR PERMITS THE USE OF CIRRUS PRODUCTS IN CRITICAL APPLICATIONS, CUSTOMER AGREES, BY SUCH USE, TO FULLY INDEMNIFY CIRRUS, ITS OFFICERS, DIRECTORS, EMPLOYEES, DISTRIBUTORS AND OTHER AGENTS FROM ANY AND ALL LIABILITY, INCLUDING ATTORNEYS' FEES AND COSTS, THAT MAY RESULT FROM OR ARISE IN CONNECTION WITH THESE USES.

Cirrus Logic, Cirrus, and the Cirrus Logic logo designs are trademarks of Cirrus Logic, Inc. All other brand and product names in this document may be trademarks or service marks of their respective owners.

LabWindows and CVI are registered trademarks of National Instruments, Inc.

Windows, Windows 2000, and Windows XP are trademarks or registered trademarks of Microsoft Corporation.

PADS and PowerLogic are trademarks of Mentor Graphics Corporation.

SPI is a trademark of Motorola Semiconductor, Inc.