



FEATURES:

- Super wide Input range
- Extremely High Input range up to 1500VDC
- Operating temperature of -40 to +70°C
- Over current and Over Voltage protection
- No minimum load required
- High efficiency of up to 80%
- I/O Isolation of 4000VAC
- Reversed connection protection



Models
Single output

Model	Input Voltage (V)	Output Voltage (V)	Output Current max (A)	Isolation (VAC)	Max Capacitive Load (uF)	Efficiency (200VDC) (%)
AM10W-60005S-NZ**	100-1000	5	2	4000	6000	72
AM10W-60009S-NZ**	100-1000	9	1.11	4000	4000	76
AM10W-60024S-NZ**	100-1000	24	0.42	4000	470	80
AM10W-80005S-NZ***	200-1500	5	2	4000	6000	64*

*Measured at 800VDC nominal input.

** For model "AM10W-60024S-NZ" only, add suffix "-STD" for optional DIN Rail screw terminal bottom plate.

***For 800VDC input models add suffix "-ST" for an optional DIN Rail screw terminal bottom plate with fuse and incorporated EMC filter, "STS" for an optional DIN Rail screw terminal bottom plate only.

NOTE: All specifications in this datasheet are measured at an ambient temperature of 25°C, humidity<75%, nominal input voltage and at rated output load unless otherwise specified.

Input Specifications

Parameters	Nominal	Typical	Maximum	Units
Voltage range	600VDC		100-1000	VDC
	800VDC		200-1500	
Input Current	600VDC input models - 200VDC		75	mA
	600VDC input models 600VDC		25	
	600VDC input models 1000VDC		16	
	800VDC input models - 200VDC		120	
	800VDC input models 800VDC		30	
	800VDC input models 1500VDC		16	
Inrush current <2ms	600VDC input models - 200VDC	7		A
	600VDC input models 600VDC	20		
	600VDC input models 1000VDC	30		
	800VDC input models - 200VDC	30		
	800VDC input models 800VDC	80		
	800VDC input models 1500VDC	150		
External fuse	600VDC input models, Slow blow	1		A
	800VDC input models, Slow blow		15A/1500VDC	
Startup time	200-1000VDC		1	s
	200-1500VDC		2	
Input under voltage protection	800VDC input models only, ON		170-185	VDC
	800VDC input models only, OFF		180-195	

Isolation Specifications

Parameters	Conditions	Typical	Maximum	Units
Tested I/O voltage	1 min	4000		VAC

Output Specifications

Parameters	Conditions	Typical	Maximum	Units
Voltage accuracy		±2		%
Line voltage regulation	LL-HL, full load	±1		% of Vin

Load voltage regulation	0-100% load	±1		%
Over voltage protection	Zener diode clamp			
Over current protection	600VDC input models		110	% of Iout
	800VDC input models		120-320	
Short Circuit protection	Continuous			
Short circuit restart	Auto recovery			
Temperature coefficient		±0.02		%/°C
Ripple & Noise	20MHz Bandwidth, 600VDC input models	100	200	mV p-p
	20MHz Bandwidth, 800VDC input models	150	300	

General Specifications

Parameters	Conditions	Typical	Maximum	Units
Switching frequency	600VDC input models, 100% load		75	KHz
	800VDC input models, 100% load	65		
Operating temperature	With derating	-40 to 70		°C
Storage temperature		-40 to 95		°C
Maximum case temperature			95	°C
Cooling	Natural convection			
Humidity			95	% RH
Case material	Heat resistant, black plastic (UL94-V0)			
Weight	600VDC input models	95 With optional -STD mounting plate: 190		g
	800VDC input models	300 With optional -ST mounting plate: 610 With optional -STS mounting plate: 360		
Dimensions (L x W x H)	600VDC input models	2.76 x 1.89 x 0.93 inches	70.00 x 48.00 x 23.50 mm	
	With optional -STD mounting plate:	3.78 x 2.13 x 1.26 inches	96.10 x 54.00 x 36.60 mm	
	800VDC input models	4.92 x 2.95 x 1.58 inches	125.00 x 75.00 x 40.00 mm	
	With optional -ST mounting plate:	5.75 x 5.43 x 2.17 inches	146.00 x 138.00 x 55.00 mm	
	With optional -STS mounting plate:	5.08 x 4.02 x 1.93 inches	129.00 x 102.00 x 49.00 mm	
MTBF	>300,000 hrs (MIL-HDBK -217F, Ground Benign, t ₊ =+25°C)			
Maximum soldering temperature	600VDC input models, 1.5mm from case for 5-10 sec		260	°C
	800VDC input models, 1.5mm from case for 3-5 sec		360	

Safety Specifications

Parameters	
Approvals	CE Designed to meet CSA-C22.2 No.107.1-01, UL 1741, EN62109
Standards	EMI - Conducted and radiated emission EN55022, class A (with the recommended EMC circuit) EN55024: 2010
	Electrostatic Discharge Immunity IEC 61000-4-2: Contact ±6KV/Air ±8KV, Criteria B
	RF, Electromagnetic Field Immunity IEC 61000-4-3: 10V/m, Criteria A
	Electrical Fast Transient/Burst Immunity (600VDC Vin) IEC 61000-4-4: ±4KV, Criteria B
	Electrical Fast Transient/Burst Immunity (800VDC Vin) IEC 61000-4-4: ±2KV, Criteria B (with the recommended EMC circuit)
	Surge Immunity (600VDC Vin) IEC 61000-4-5: ±2KV, Criteria B
	Surge Immunity (800VDC Vin) IEC 61000-4-5: ±1KV, Criteria B (with the recommended EMC circuit)
	RF, Conducted Disturbance Immunity IEC 61000-4-6: 10Vrms, Criteria A
	Power frequency Magnetic Field Immunity IEC 61000-4-8: 10A/m, Criteria A
	Voltage dips, Short Interruptions Immunity IEC 61000-4-11: 0-70%, Criteria B

Pin Out Specifications

Pin	600VDC Input
1	N.C.
2	-Vin
3	+Vin
4	-Vout
5	+Vout

N.C. Not connected

Dimensions
600VDC input models

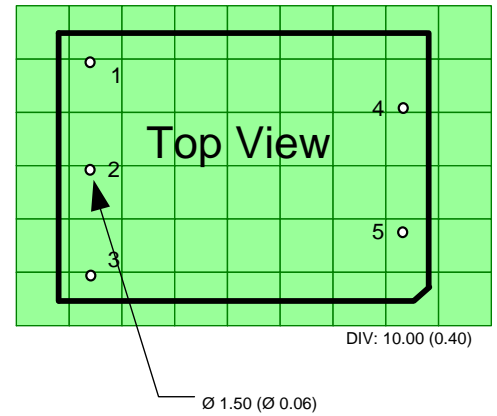
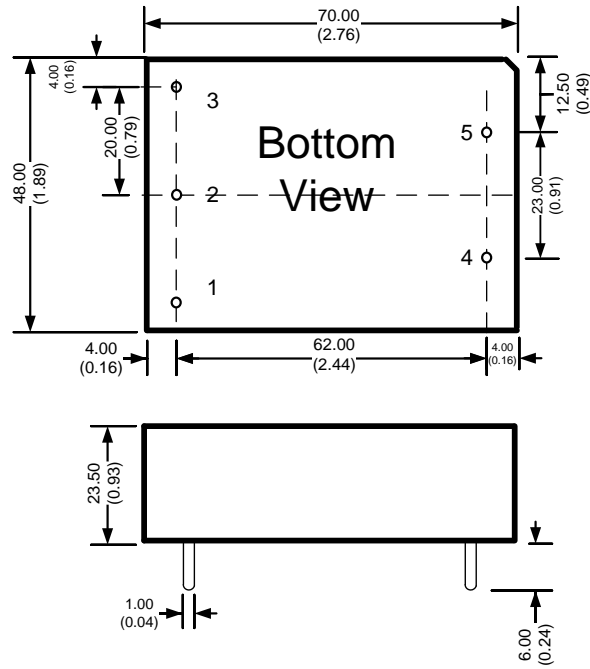

Dimensions mm (inch)
Case Tolerance ± 0.50 (± 0.02)
Pin Diameter ± 0.10 (± 0.004)

600VDC input models with optional -STD bottom plate

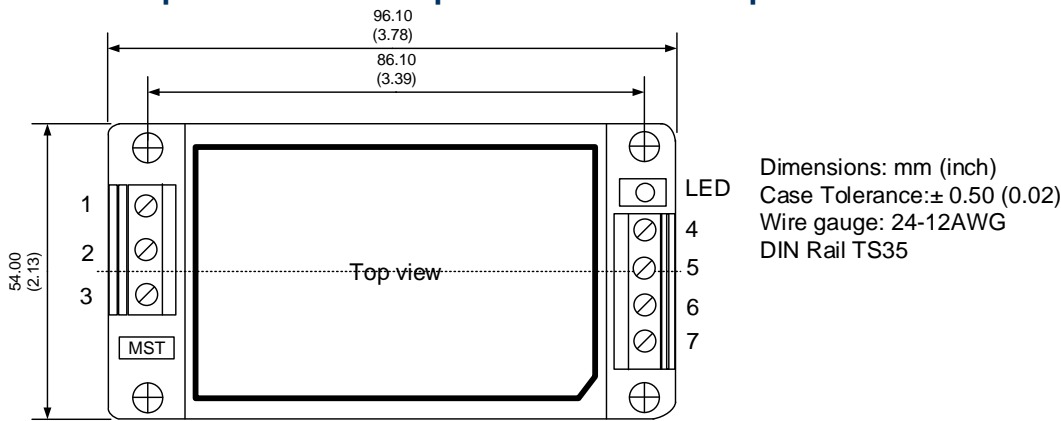

Pin Out Specifications

Pin	Single
1	-Vin
2	N.C.
3	+Vin
4	-Vout
5	N.C.
6	N.C.
7	+Vout

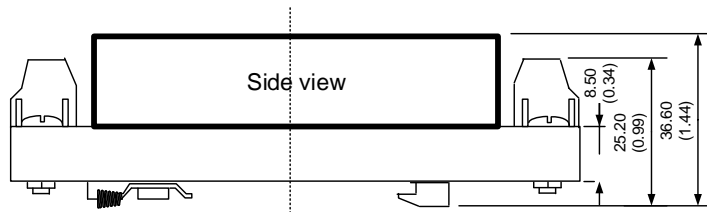

800VDC input models

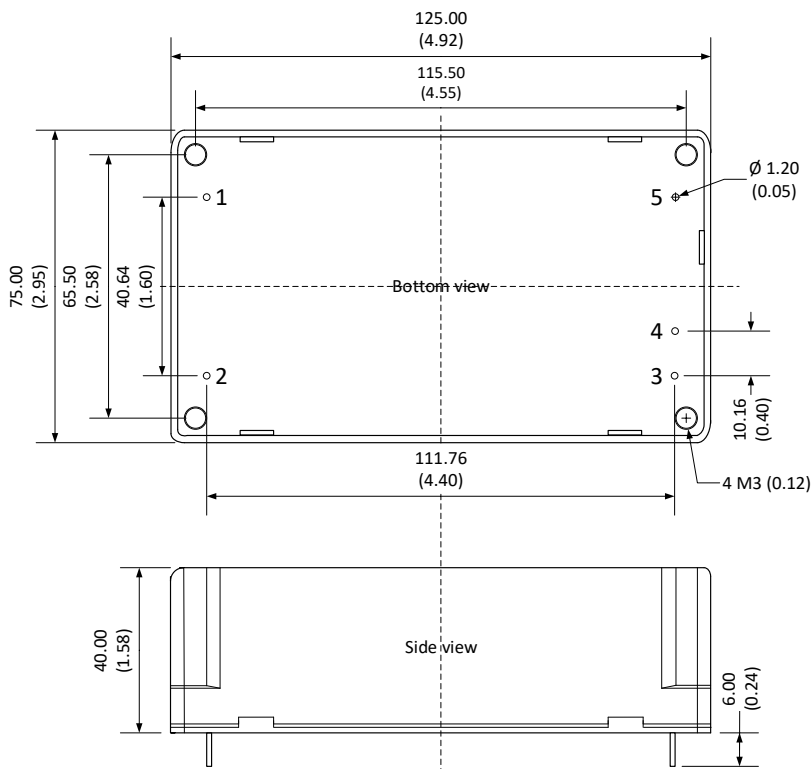

Pin Out Specifications

Pin	800VDC Input
1	+Vin
2	-Vin
3	+Vout
4	-Vout
5	N.C.

Dimensions mm (inch)
Case Tolerance ± 0.50 (± 0.02)
Pin Diameter Tolerance ± 0.10 (± 0.004)
Pin Length Tolerance ± 1.50 (± 0.06)

800VDC input models with optional -ST bottom plate

Pin Out Specifications

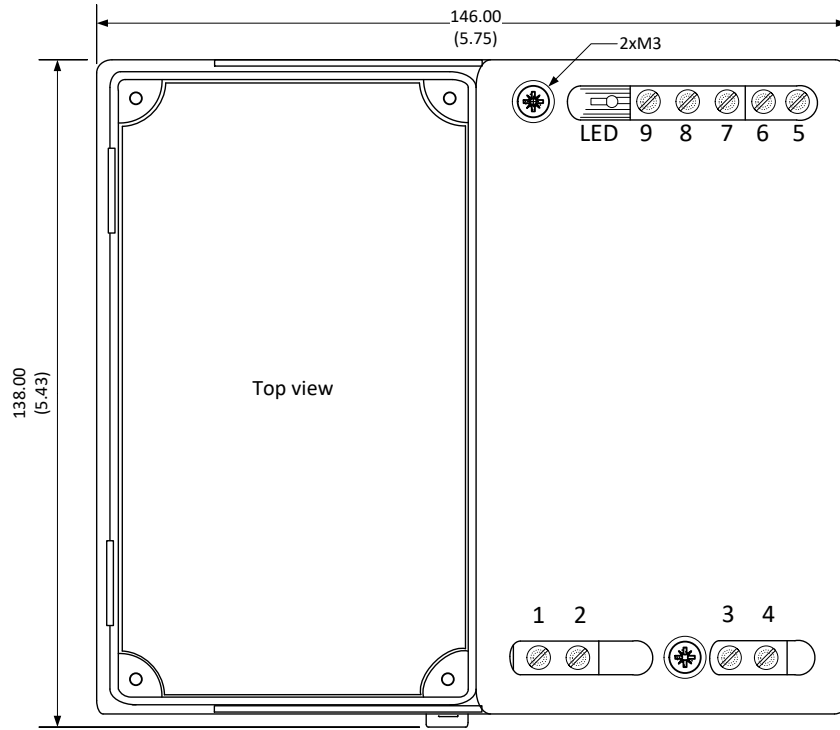

Pin	Single
1	-Vin
2	-Vin
3	+Vin
4	+Vin
5	+Vout
6	-Vout
7	N.C.
8	N.C.
9	N.C.

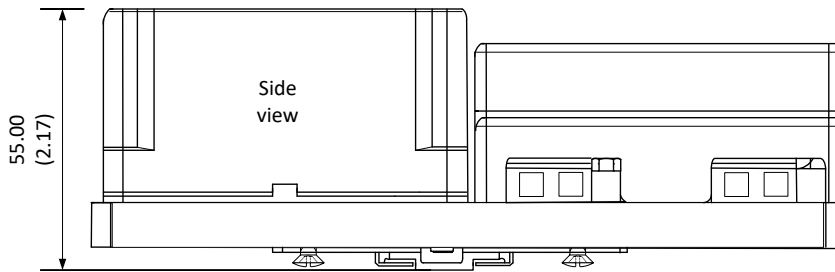

Dimensions mm (inch)
 Installed on DIN rail type TS35
 Wire: 24-12AWG
 Case Tolerance ± 0.50 (± 0.02)
 General Tolerance ± 1.00 (± 0.04)

NOTES:

1. To replace the internal fuse in the models with suffix "-ST", unscrew the 2 screws on the top side of the plate.
2. DIN rail metal holder needs to be grounded.
3. Horizontal mounting recommended.

800VDC input models with optional -STS bottom plate

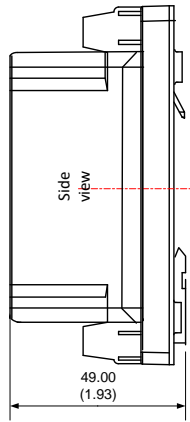
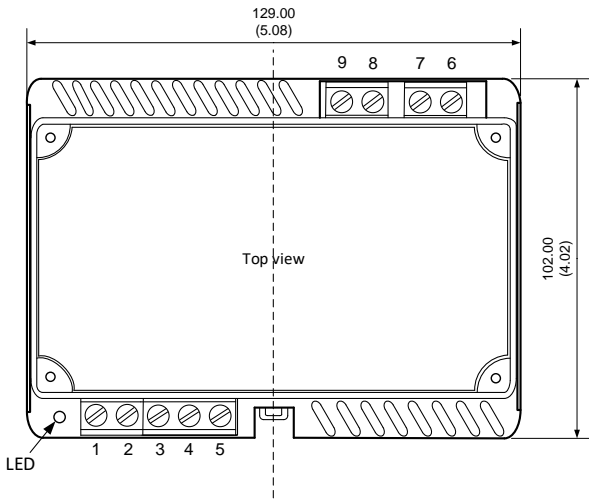

Pin Out Specifications

Pin	Single
1	+V out
2	-V out
3	N.C.
4	N.C.
5	N.C.
6	+V in
7	+V in
8	-V in
9	-V in

Derating

600VDC input models

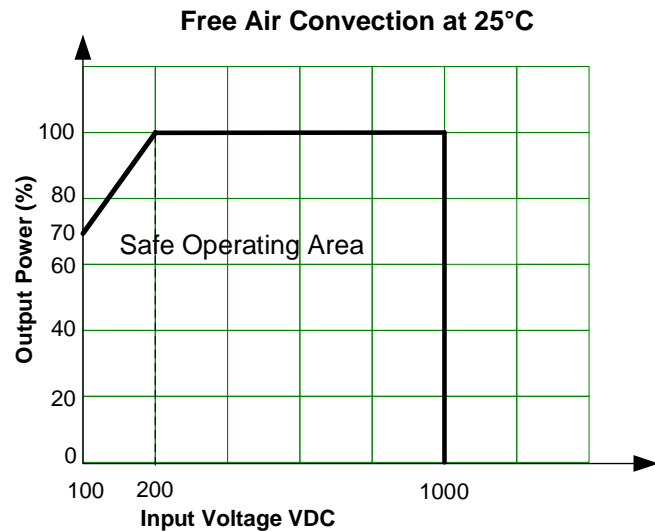
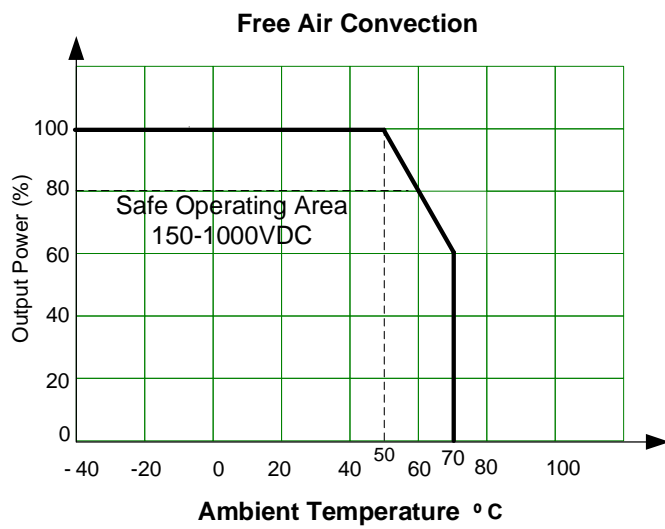
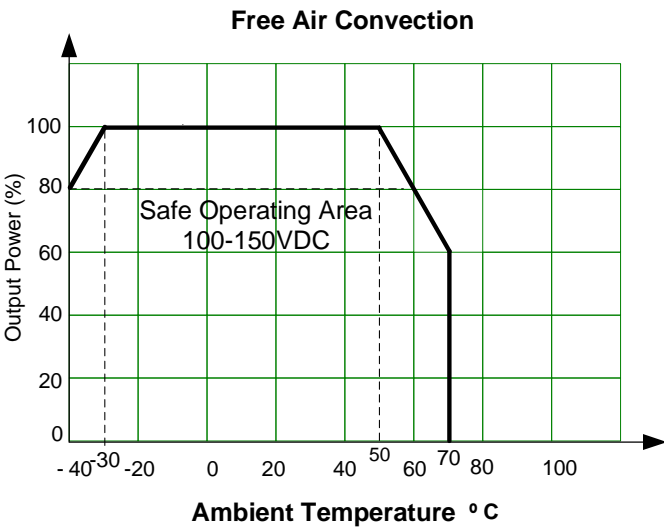

NOTE: 1. Derated Pout = Pout * temp. derating * Vin derating.
2. Sufficient air space for natural air flow around must be considered.

800VDC input models*

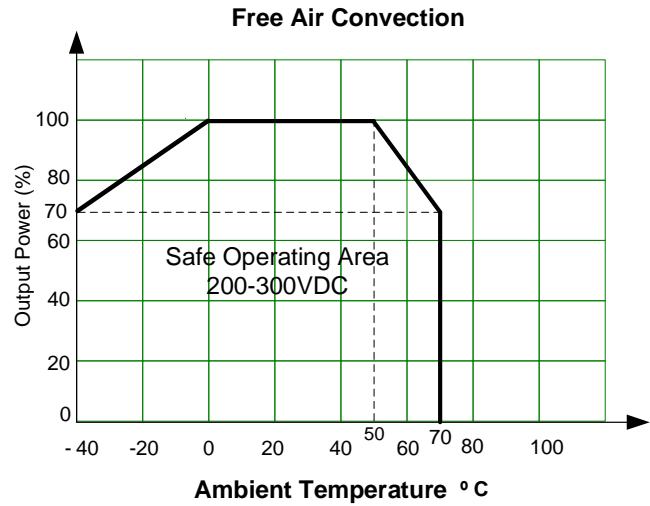
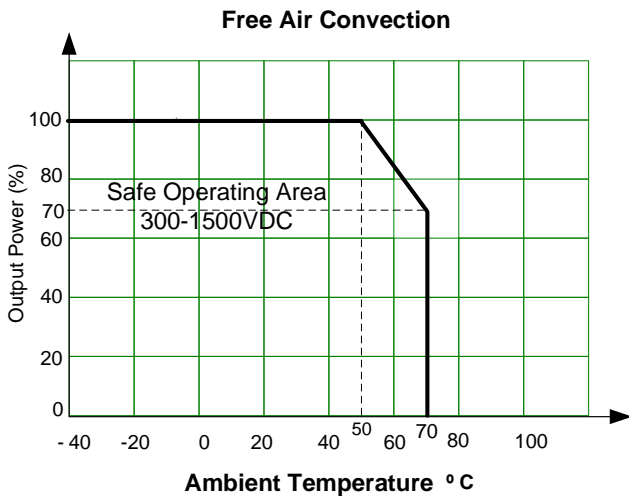

*NOTE: Derating is indicated at natural convection. Sufficient air space around is needed.

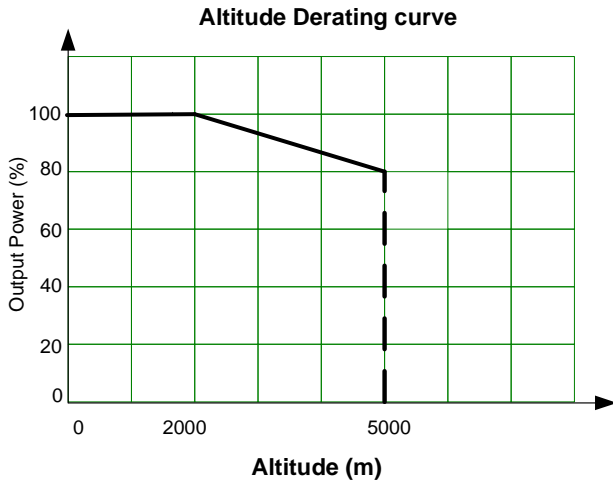

Efficiency curve

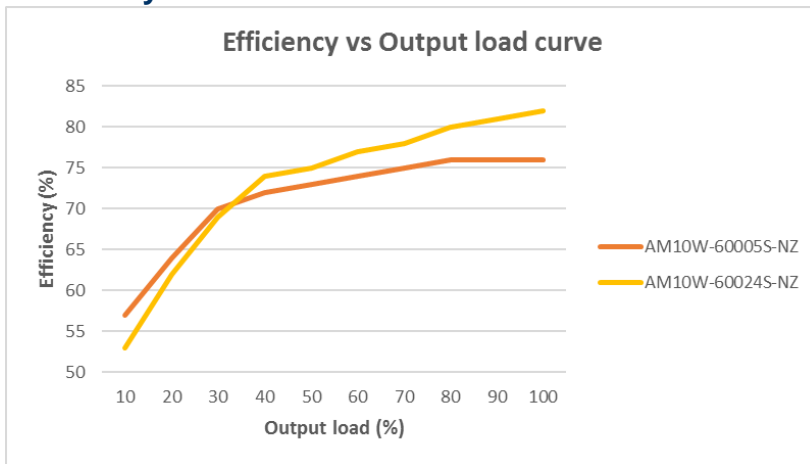

Typical Application circuit *

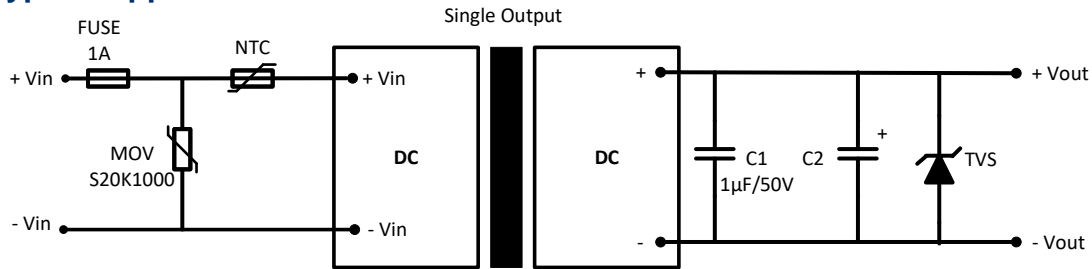

Model	C2	TVS
5 Vout	220 µF / 35V	7V
9 Vout	120 µF / 35V	12V
24 Vout	68 µF / 35V	33V

*NOTE: For 800VDC Input models NTC and MOV are not needed. For 800VDC input models with suffix “-ST” this external circuit is not needed.

Recommended EMC Circuit

600VDC input models

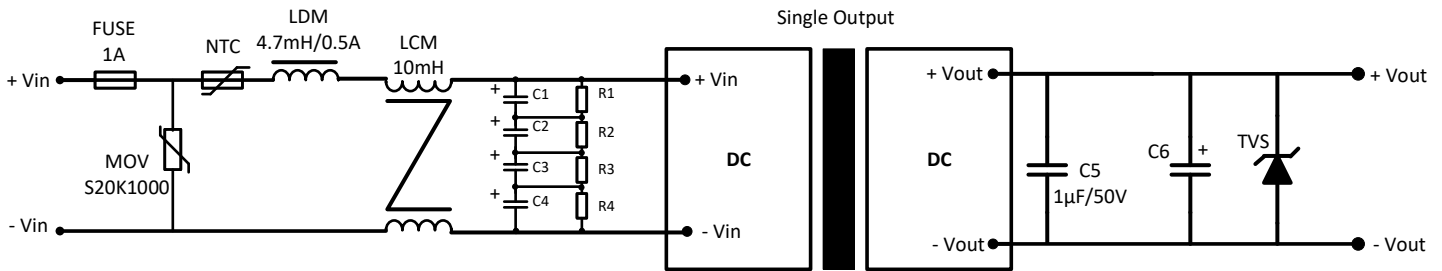

800VDC input models

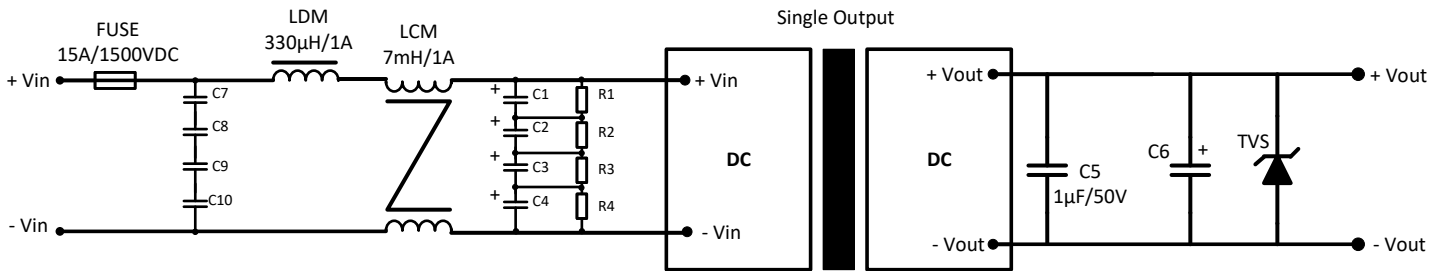

Model	C1, C2, C3 & C4	C7, C8, C9 & C10	R1, R2, R3 & R4	C6	TVS
5 Vout	47 µF/450V	100 nF/275V	1MΩ / 2W	220 µF / 35V	7V
9 Vout				120 µF / 35V	12V
24 Vout				68 µF / 35V	33V

*NOTE: For 800VDC input models with suffix “-ST” this external EMC circuit is not needed.

NOTE: 1. Datasheets are updated as needed and as such, specifications are subject to change without notice. Once printed or downloaded, datasheets are no longer controlled by Aimtec; refer to www.aimtec.com for the most current product specifications. 2. Product labels shown, including safety agency certifications on labels, may vary based on the date manufactured. 3. Mechanical drawings and specifications are for reference only. 4. All specifications are measured at an ambient temperature of 25°C, humidity<75%, nominal input voltage and at rated output load unless otherwise specified. 5. Aimtec may not have conducted destructive testing or chemical analysis on all internal components and chemicals at the time of publishing this document. CAS numbers and other limited information are considered proprietary and may not be available for release. 6. This product is not designed for use in critical life support systems, equipment used in hazardous environments, nuclear control systems or other such applications which necessitate specific safety and regulatory standards other the ones listed in this datasheet. 7. Warranty is in accordance with Aimtec’s standard Terms of Sale available at www.aimtec.com.