



5G PHANTOM ON-GROUND PLANE SERIES

5G low profile on-ground plane antennas
617-7125 MHz/698-7125 MHz

The 5G Phantom on-ground plane antenna series cover either 617-7125 or 698-7125 MHz and are both available in black or white.

5G Phantom antennas deliver global cellular coverage, even for regions where the lower 600 MHz band is required. They offer high levels of average efficiency, over 80% up to 4200 MHz, and gain up to 6.0 dBi in an IP67-rated, compact form factor.

A direct-mount, threaded stud, with superior quality and integrated N-female connector provides tamper-resistant installation. The direct coaxial connection ensures performance remains consistent, even at the higher frequencies, avoiding the performance losses of other mounting methods.

FEATURES AND BENEFITS

- **Based on our popular Phantom series** – Our highly-popular Phantom antennas are widely used in applications such as utilities, vehicular, public safety, and other IoT installations
- **Global cellular coverage** – Available in 617-7125 MHz and 698-7125 MHz variants
- **Optimized** – Optimal gain directed at just above the horizon for superior connectivity with exceptional efficiency levels
- **Minimum gain ripple** - Around the horizon (Azimuth Plane) there is excellent consistency with minimal shifting gain; unlike competitors
- **Connectivity where you need it** – Uniform azimuth patterns reduce the chance of signal drop outs
- **Rugged, robust construction** – Tamper-resistant and highly durable with IP67-rated enclosure and UL 94 flammability rating
- **Guaranteed** – Backed by our industry-leading 5- year warranty

ELECTRICAL SPECIFICATION

Model Name	FTRA6171M5PB-001/FTRA6171M5PW-001							
Operating Frequency (MHz)	617-698	698-960	1427-1695	1695-2700	3300-4200	4400-6000	6000-6500	6500-7125
VSWR (Max)	<2.5:1	<2.0:1	<4.0:1	<2.0:1	<2.0:1	<2.5:1	<3.0:1	
Peak Gain (Average), dBi	4.5	4.5	5.0	5.5	6.0	6.0	6.5	7.5
Ave. Gain at Theta 80 deg. (10 deg above Horiz.); dBi	0.3	0.5	-	1.5	1.0	.7	-	-
Efficiency (%), Avg	>70	>80	> 50	>80	>80	>80	-	-
Model Name	FTRA6971M5PB-001/FTRA6971M5PB-001							
Operating Frequency (MHz)	N/A	698-960	1427-1695	1695-2700	3300-4200	4400-6000	6000-6875	6875-7125
VSWR (Max)	N/A	<2.3:1	<3.0:1	<2.0:1	<2.0:1	<2.5:1	<3.0:1	
Peak Gain (Average), dBi	N/A	4.3	5.4	5.7	6.2	5.6	5.7	7.2
Typ. Ave. Gain at Theta 80 deg. (10 deg above Horiz.); dBi	N/A	0.3	1.5	1.6	1.9	2.0	-	
Efficiency (%), Avg	N/A	>80	>80	>80	>80	>75	-	
Polarization	Vertical							
Azimuth (Horizontal) Beamwidth	360°							
Nominal Impedance (Ohms)	50							
Max Power @ Ambient 25°C (W)	100			20				

MECHANICAL SPECIFICATION

Dimensions - H x D Bottom-D Top - mm (inches)	FTRA6171M5Pxx: 92 x 45 (3.62 x 1.77)	FTRA6971M5Pxx: 84 x 45-32 (3.78 x 1.81-1.26)
Weight - kg (lbs.)	FTRA6171M5Pxx: 0.145 (0.32)	FTRA6971M5Pxx: 0.138 (0.30)
Radome Material	Polycarbonate	
Connector Type	Type N (female)	

ENVIRONMENTAL SPECIFICATION

Operating Environment (Indoor or Outdoor)	Outdoor
Operating Temperature - °C (°F)	-40 to +85°C (-40 to +185°F)
Storage Temperature - °C (°F)	-40 to +85°C (-40 to +185°F)
Ingress Protection Rating	IP67
Flammability Rating	UL94 V0
Material Substance Compliance	RoHS

CONFIGURATION

PART NUMBER	OPERATING FREQUENCY	COLOR
FTRA6171M5PB-001	617 - 7125 MHz	BLACK
FTRA6171M5PW-001	617 - 7125 MHz	WHITE
FTRA6971M5PB-001	698 - 7125 MHz	BLACK
FTRA6971M5PW-001	698 - 7125 MHz	WHITE

MECHANICAL DRAWING

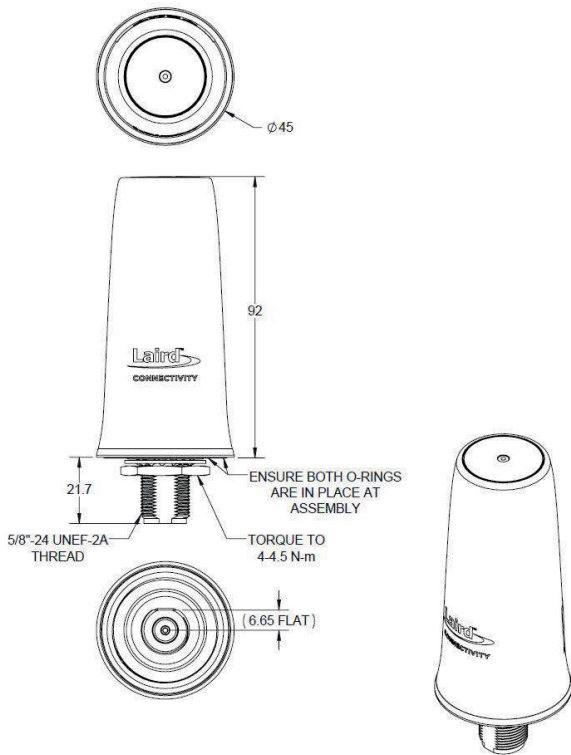

Figure 1: FTRA6171M5Px mechanical drawing

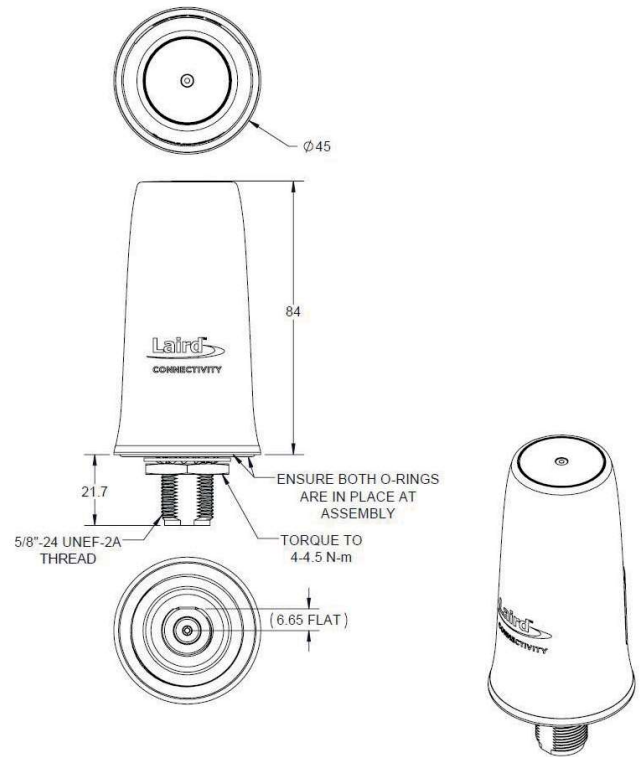
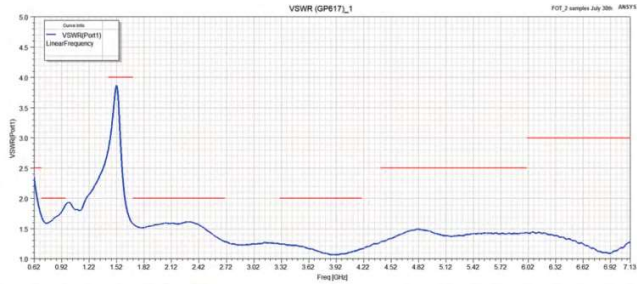
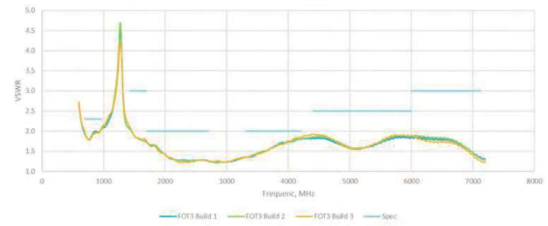

Figure 2: FTRA6971M5Px mechanical drawing

VSWR VS FREQUENCY



FTRA6171M5Px



FTRA6971M5Px

PEAK GAIN VS FREQUENCY

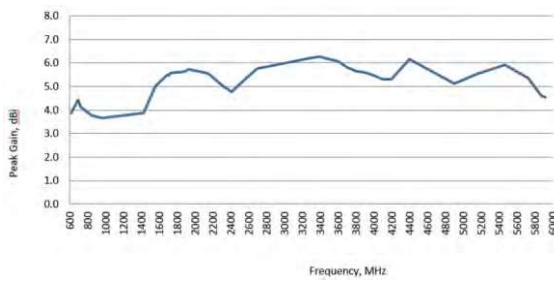

FTRA6171M5Px

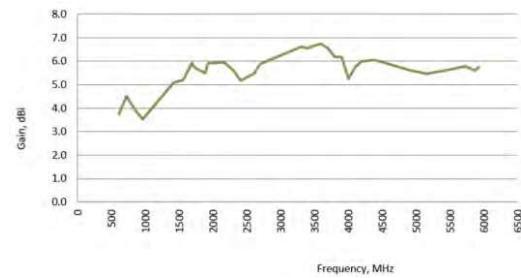

FTRA6971M5Px

RADIATED EFFICIENCY VS FREQUENCY

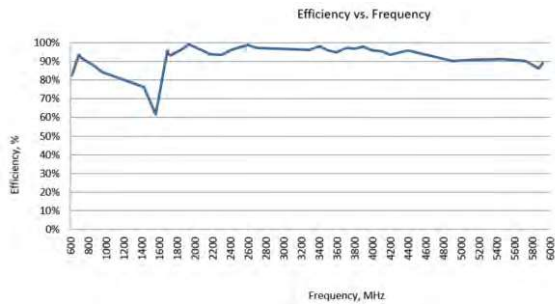

FTRA6171M5Px

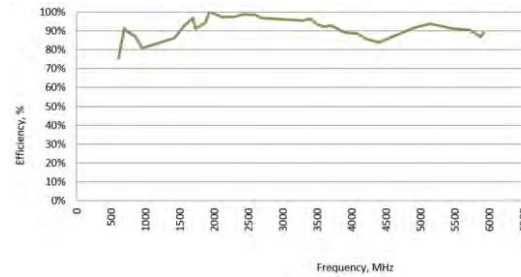

FTRA6971M5Px

GAIN RIPPLE VS FREQUENCY

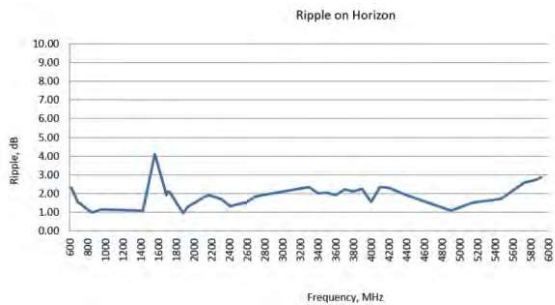

FTRA6171M5Px

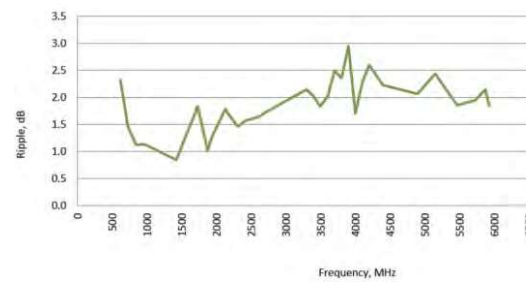

FTRA6971M5Px

RADIATION PATTERNS

617 MHz (FTRA6171M5Px)

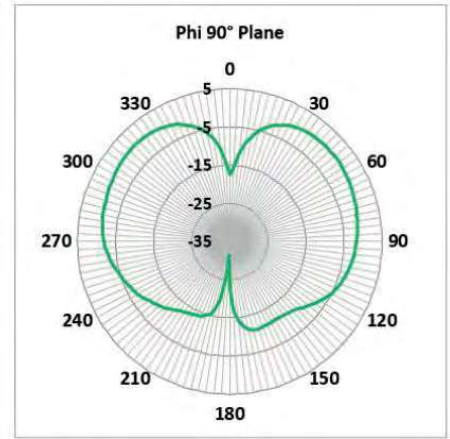
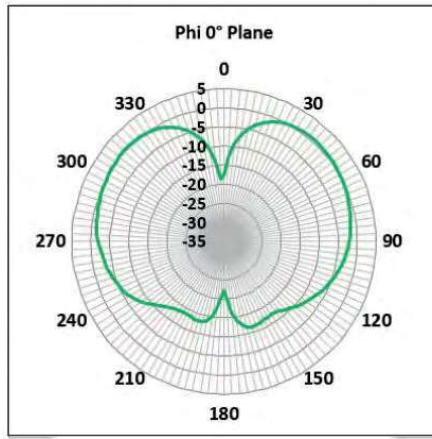
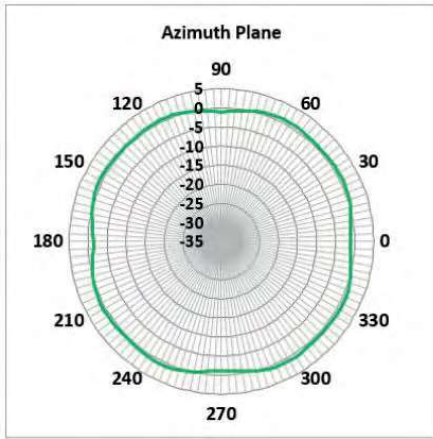

698 MHz (FTRA6171M5Px)

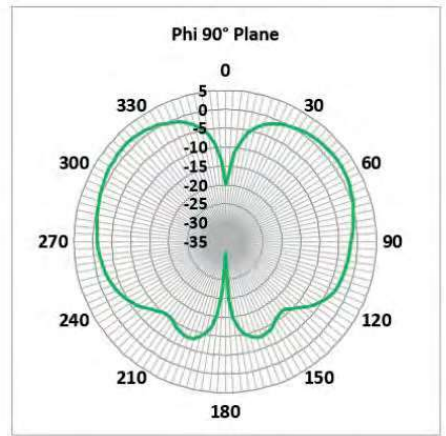
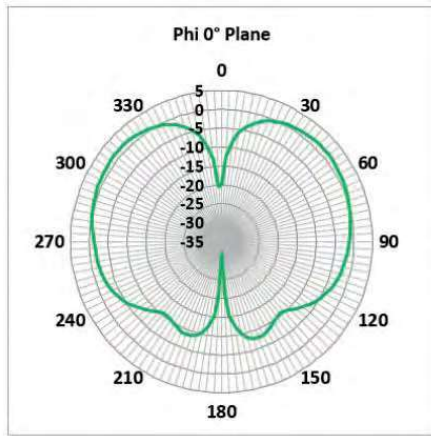
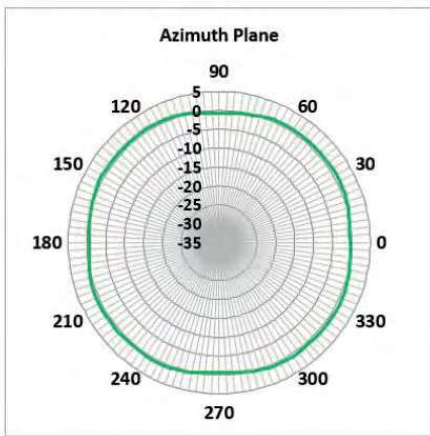

960 MHz (FTRA6171M5Px)

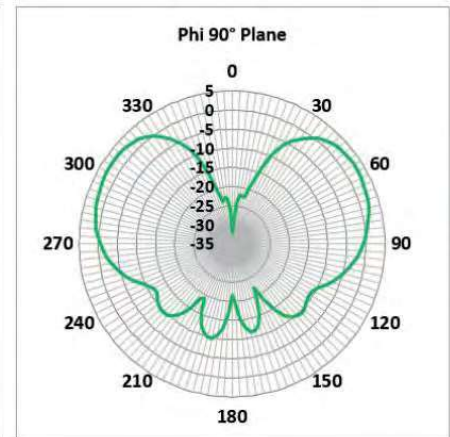
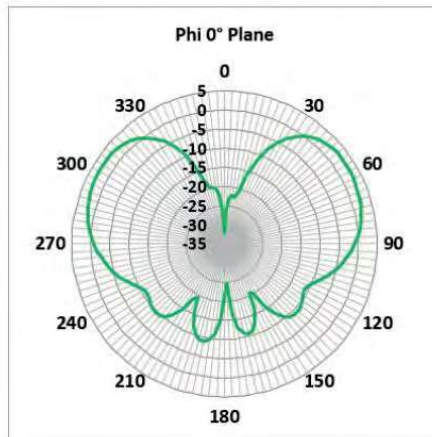
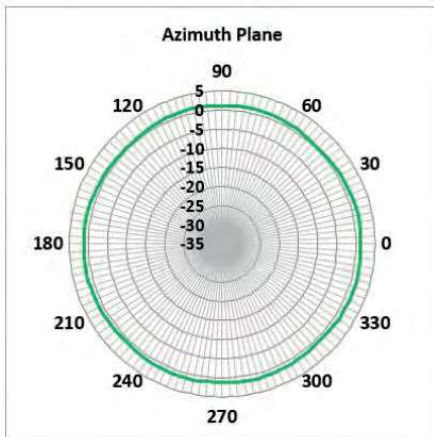

1427M Hz (FTRA6171M5Px)

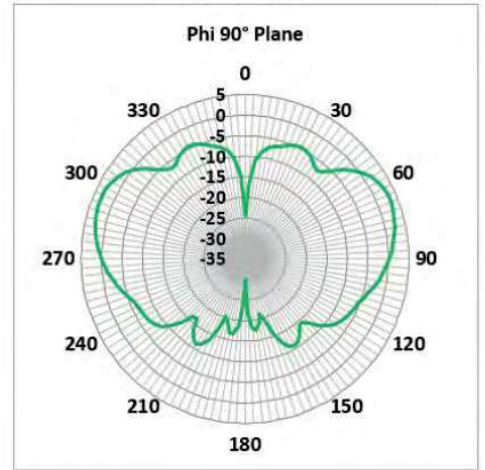
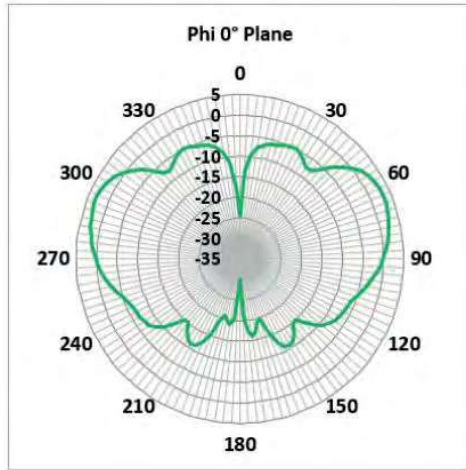
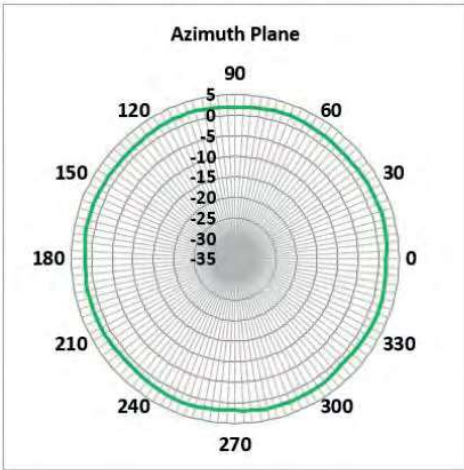

1695M Hz (FTRA6171M5Px)

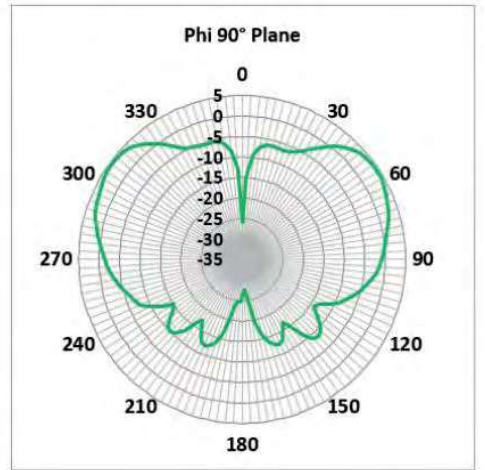
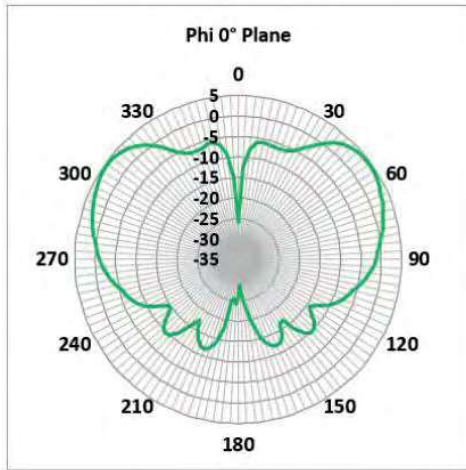
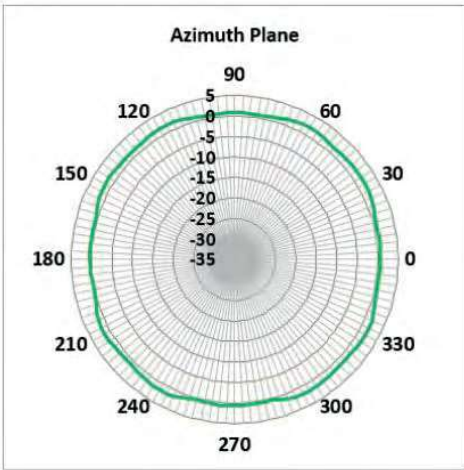

2170M Hz (FTRA6171M5Px)

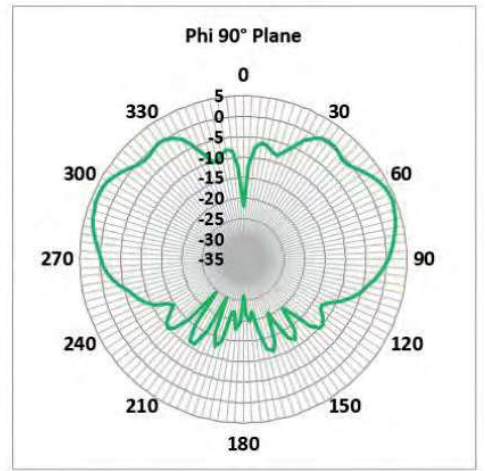
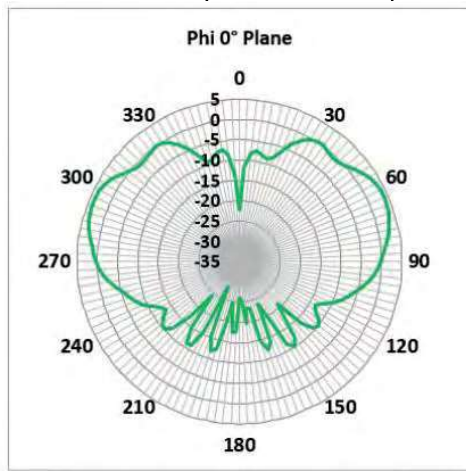
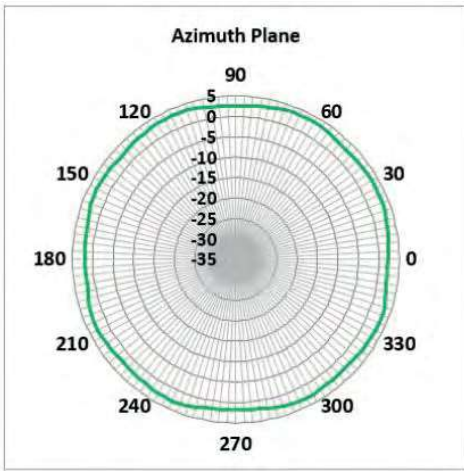

2310M Hz (FTRA6171M5Px)

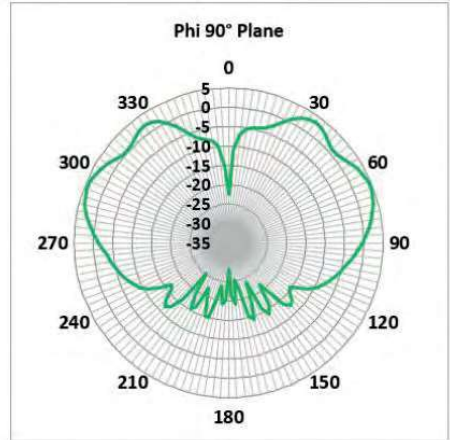
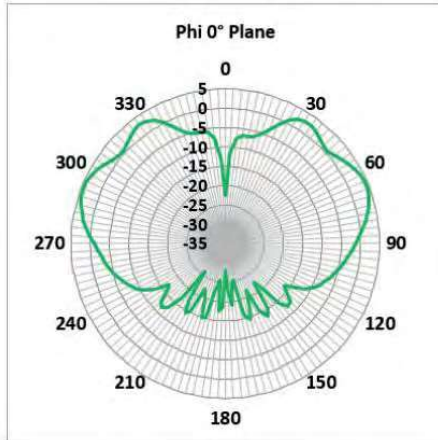
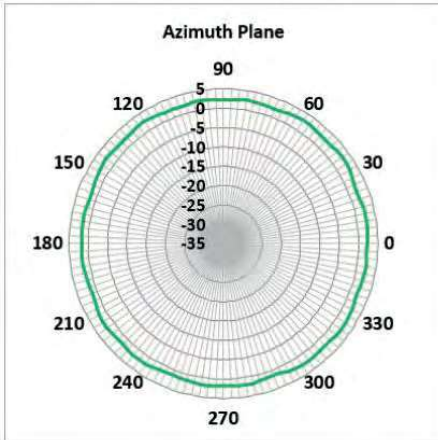

2700M Hz (FTRA6171M5Px)

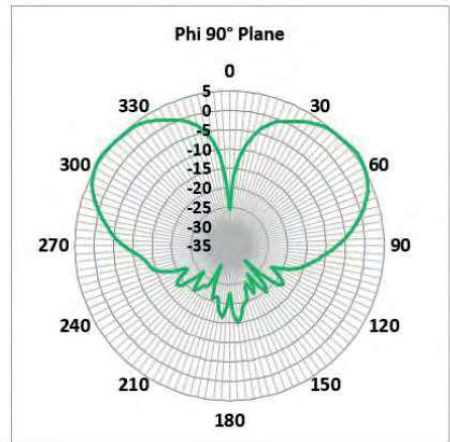
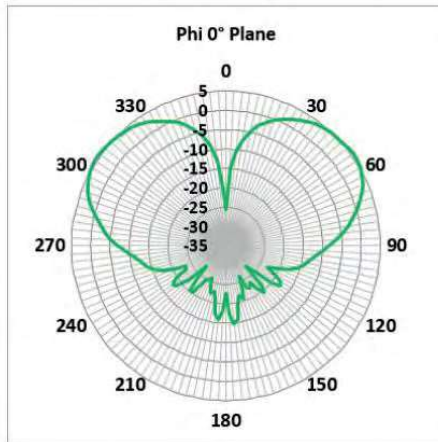
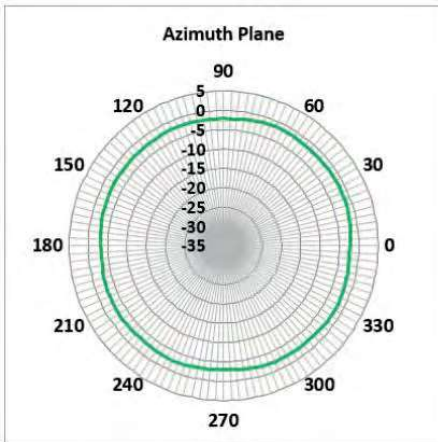

3300M Hz (FTRA6171M5Px)

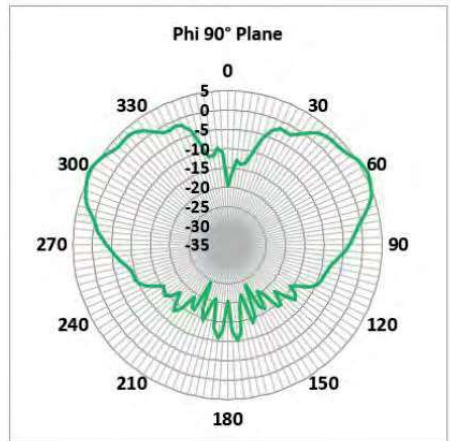
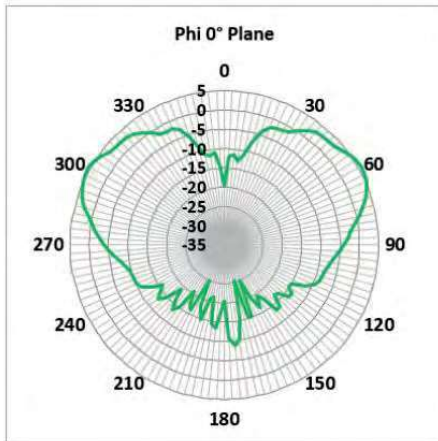
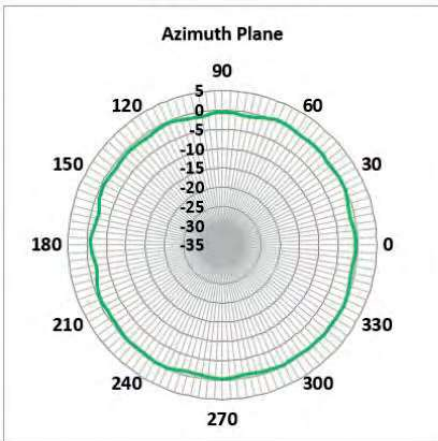

3800 MHz (FTRA6171M5Px)

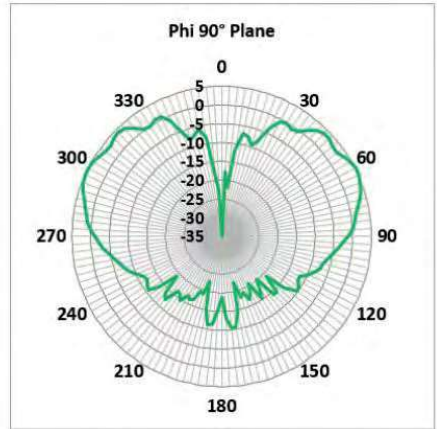
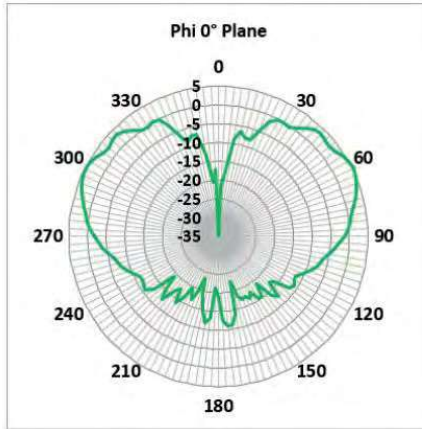
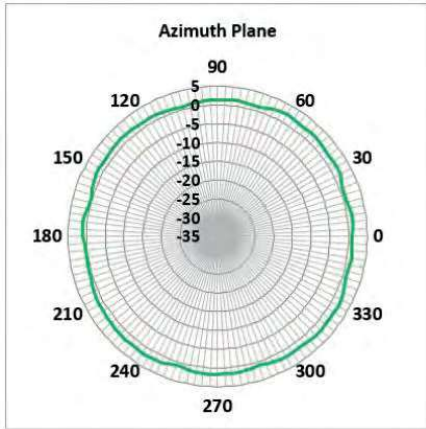

4200 MHz (FTRA6171M5Px)

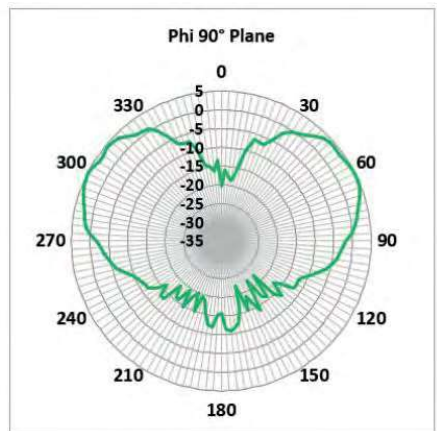
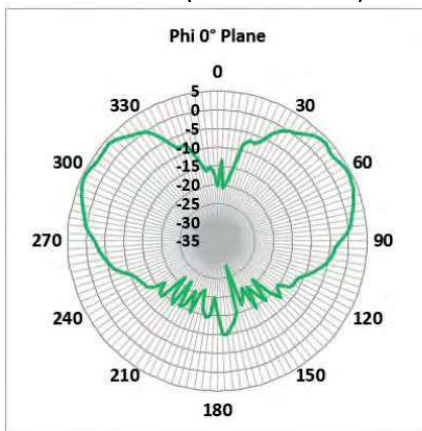
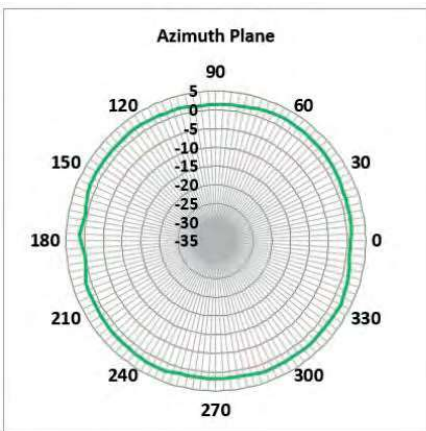

4400 MHz (FTRA6171M5Px)

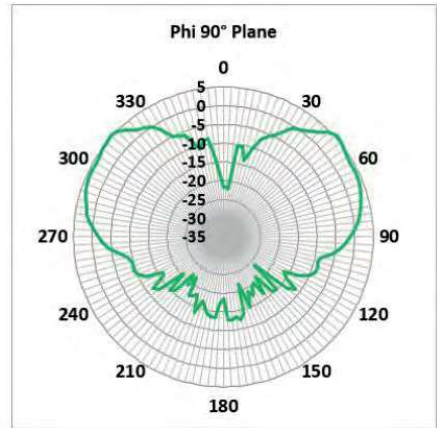
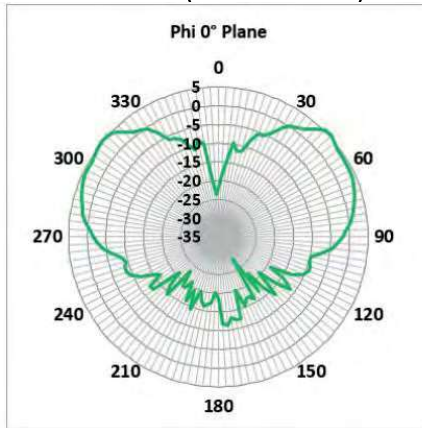
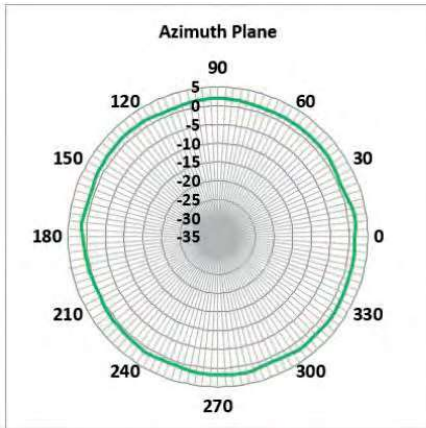

5150 MHz (FTRA6171M5Px)

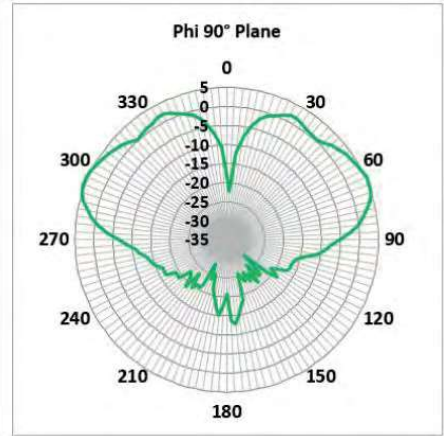
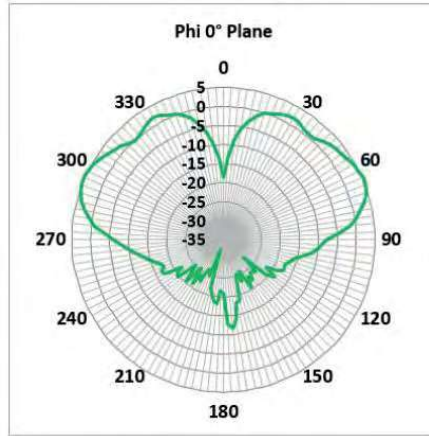
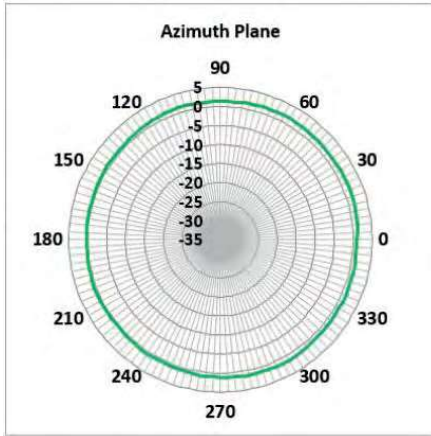

5470 MHz (FTRA6171M5Px)

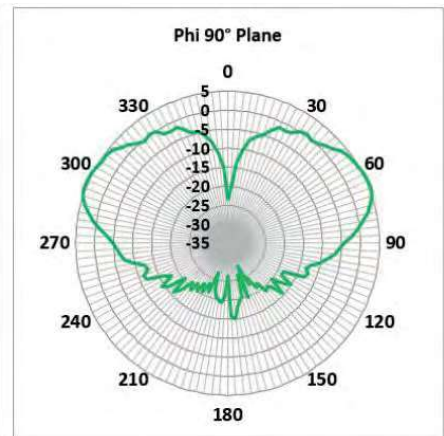
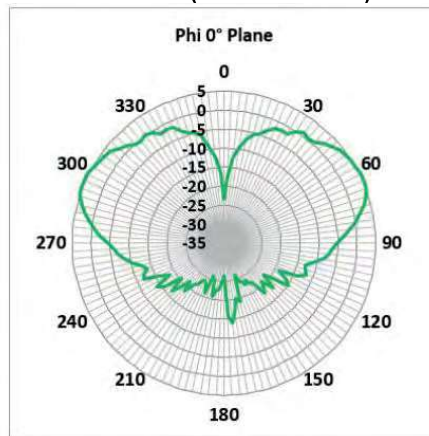
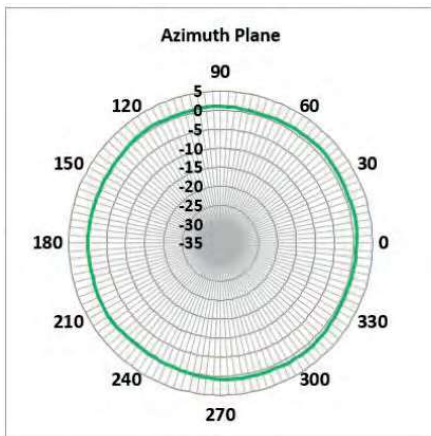

5925 MHz (FTRA6171M5Px)

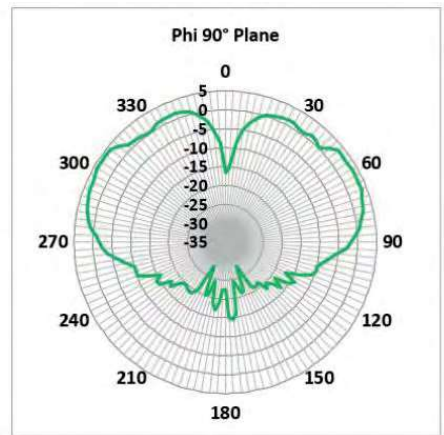
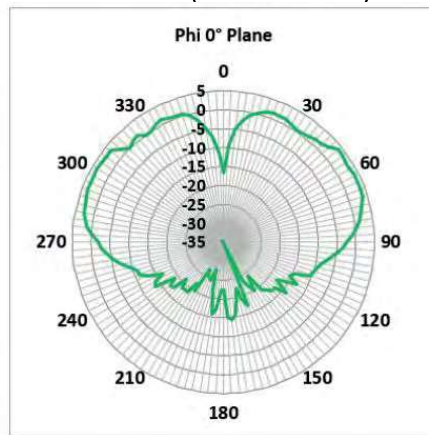
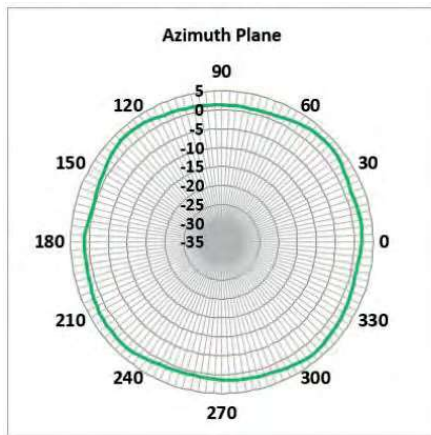

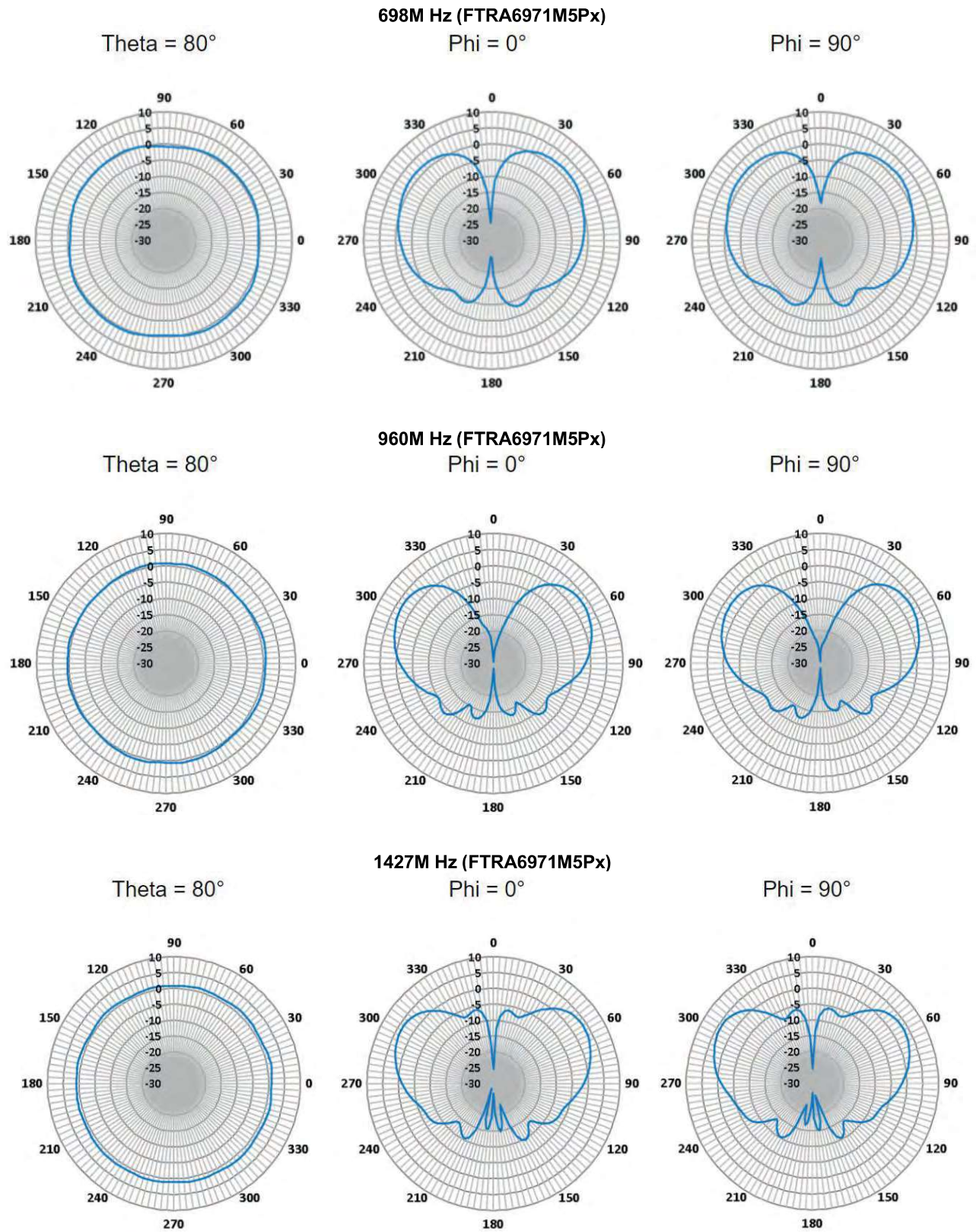

1695M Hz (FTRA6971M5Px)

Theta = 80°

Phi = 0°

Phi = 90°

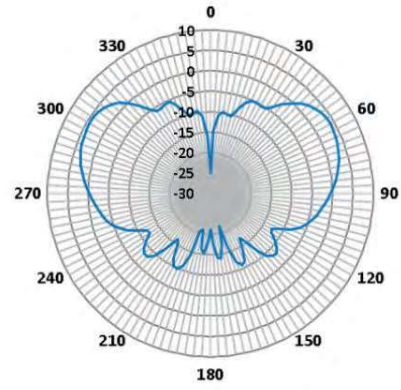
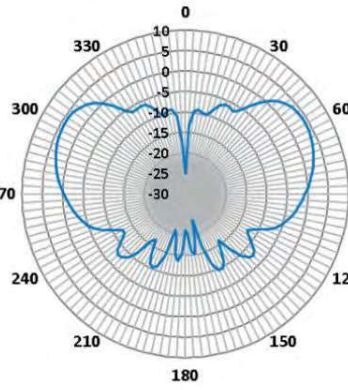
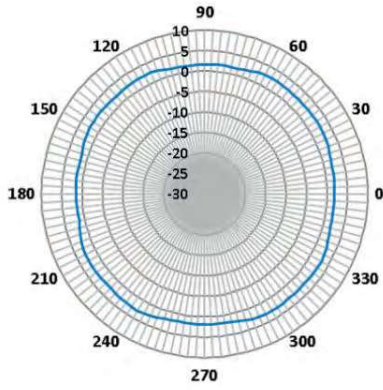

2170M Hz (FTRA6971M5Px)

Theta = 80°

Phi = 0°

Phi = 90°

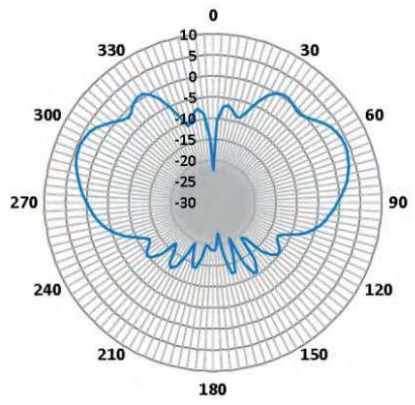
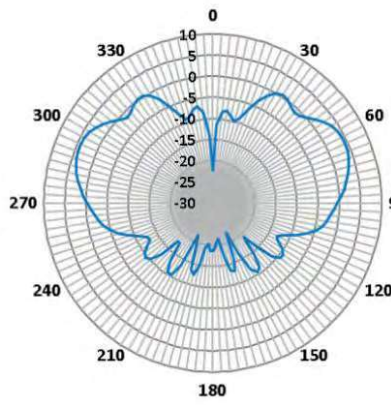
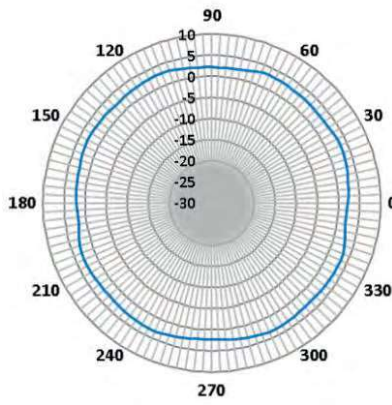

2310M Hz (FTRA6971M5Px)

Theta = 80°

Phi = 0°

Phi = 90°

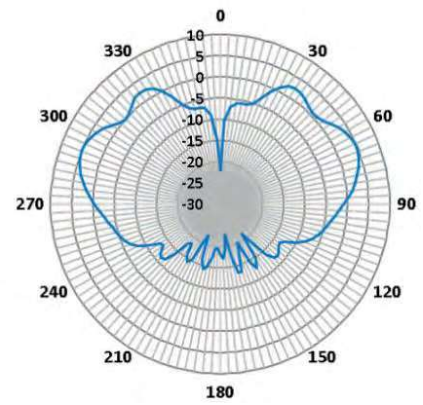
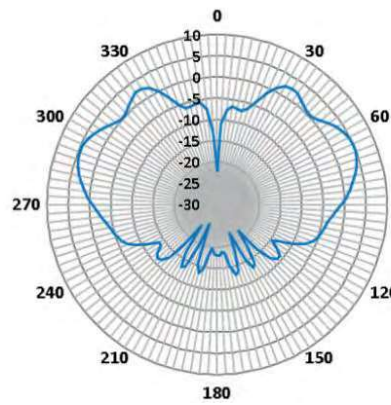
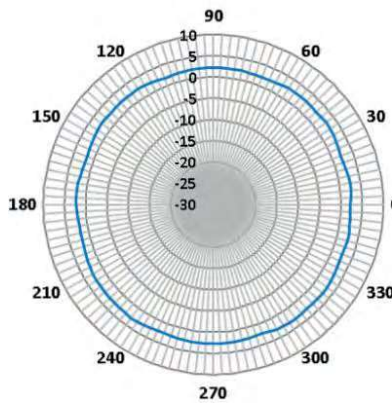

2700M Hz (FTRA6971M5Px)

Theta = 80°

Phi = 0°

Phi = 90°

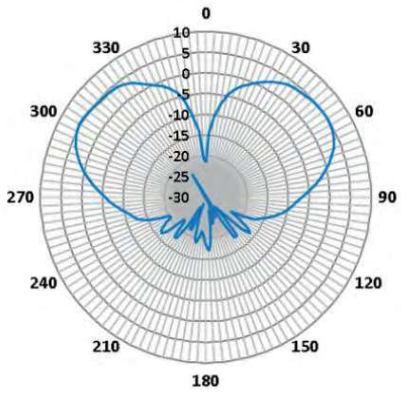
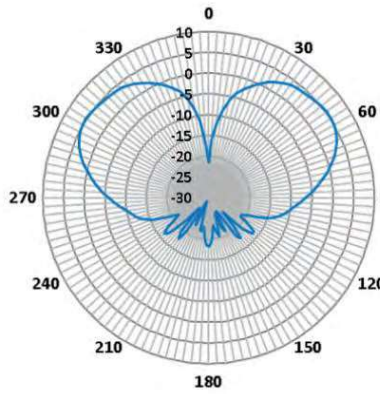
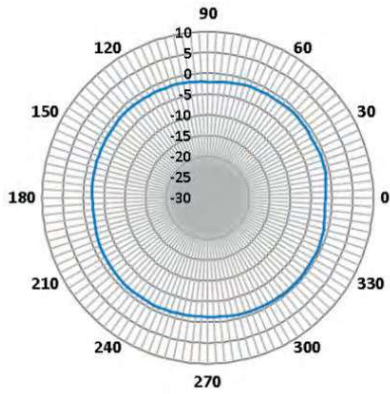

3300M Hz (FTRA6971M5Px)

Theta = 80°

Phi = 0°

Phi = 90°

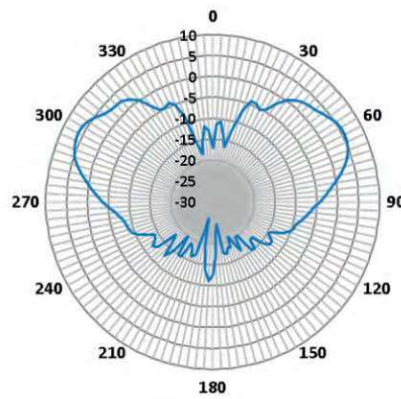
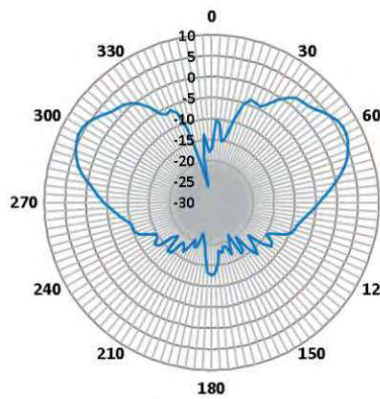
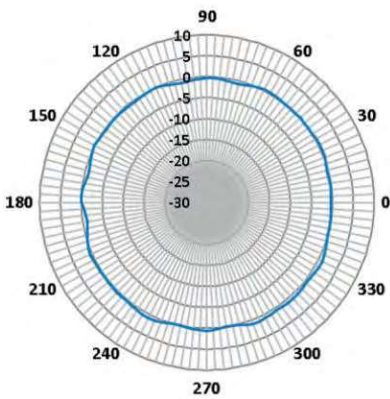

3800M Hz (FTRA6971M5Px)

Theta = 80°

Phi = 0°

Phi = 90°

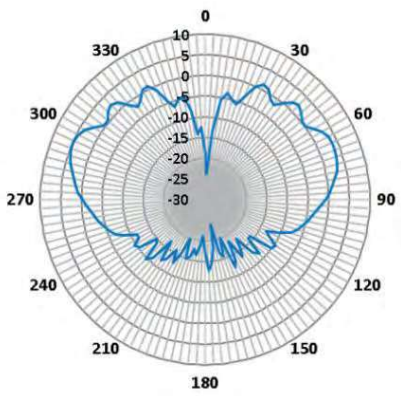
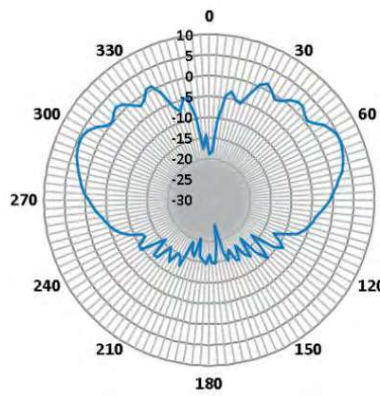
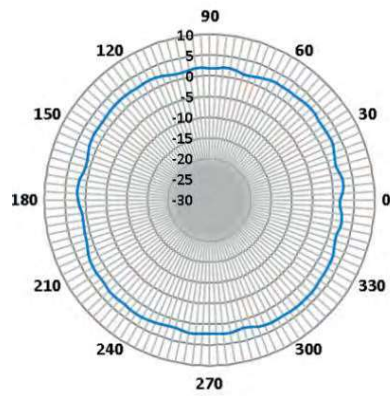

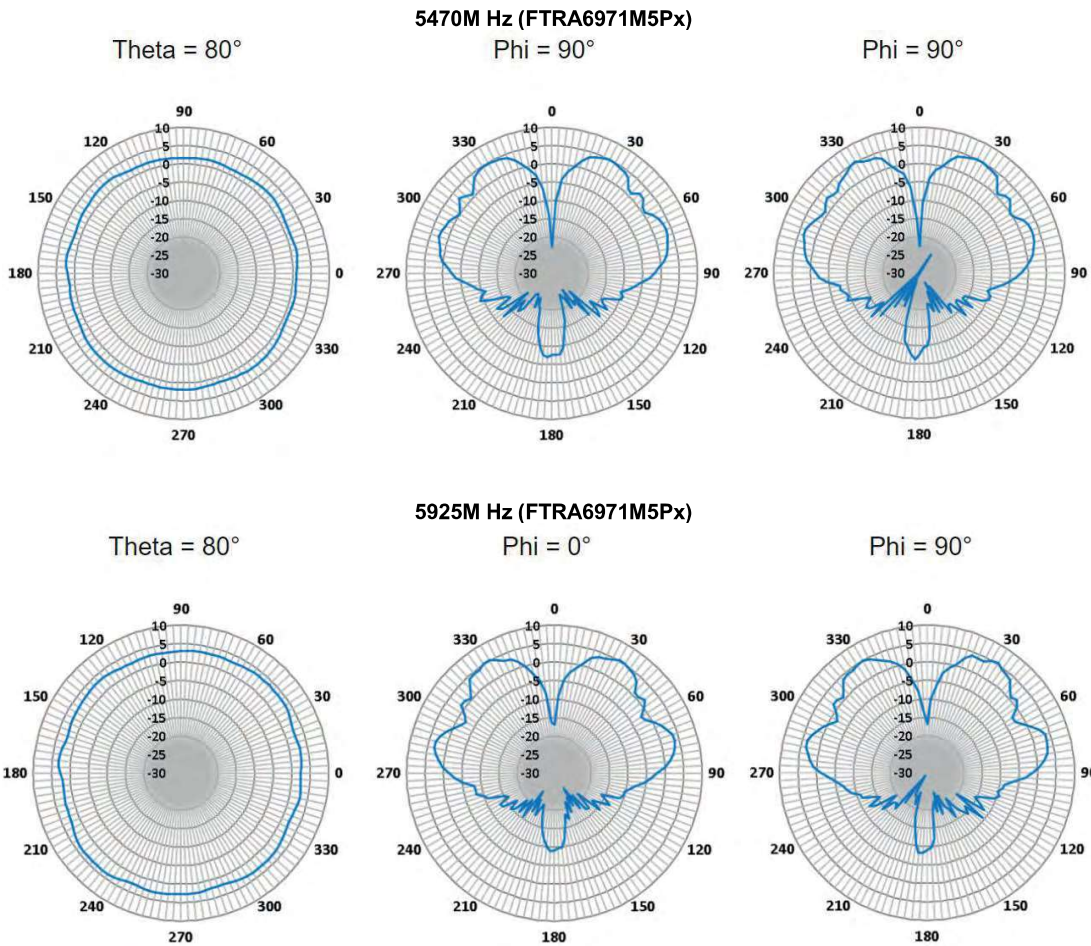

TE TECHNICAL SUPPORT CENTER

USA:	+1 (800) 522-6752
Canada:	+1 (905) 475-6222
Mexico:	+52 (0) 55-1106-0800
Latin/S. America:	+54 (0) 11-4733-2200
Germany:	+49 (0) 6251-133-1999
UK:	+44 (0) 800-267666
France:	+33 (0) 1-3420-8686
Netherlands:	+31 (0) 73-6246-999
China:	+86 (0) 400-820-6015

te.com

TE, and TE connectivity (logo) are trademarks owned or licensed by the TE Connectivity Ltd. family of companies. All other logos, products and/or company names referred to herein might be trademarks of their respective owners.

The information given herein, including drawings, illustrations and schematics which are intended for illustration purposes only, is believed to be reliable. However, TE Connectivity makes no warranties as to its accuracy or completeness and disclaims any liability in connection with its use. TE Connectivity's obligations shall only be as set forth in TE Connectivity's Standard Terms and Conditions of Sale for this product and in no case will TE Connectivity be liable for any incidental, indirect or consequential damages arising out of the sale, resale, use or misuse of the product. Users of TE Connectivity products should make their own evaluation to determine the suitability of each such product for the specific application.

TE Connectivity warrants to the original end user customer of its products that its products are free from defects in material and workmanship. Subject to conditions and limitations TE Connectivity will, at its option, either repair or replace any part of its products that prove defective because of improper workmanship or materials. This limited warranty is in force for the useful lifetime of the original end product into which the TE Connectivity product is installed. Useful lifetime of the original end product may vary but is not warranted to exceed one (1) year from the original date of the end product purchase.

©2022 TE Connectivity, All Rights Reserved.

08/22 Original