

FS-2006L-S

SHOCK ABSORBER - ADJUSTABLE

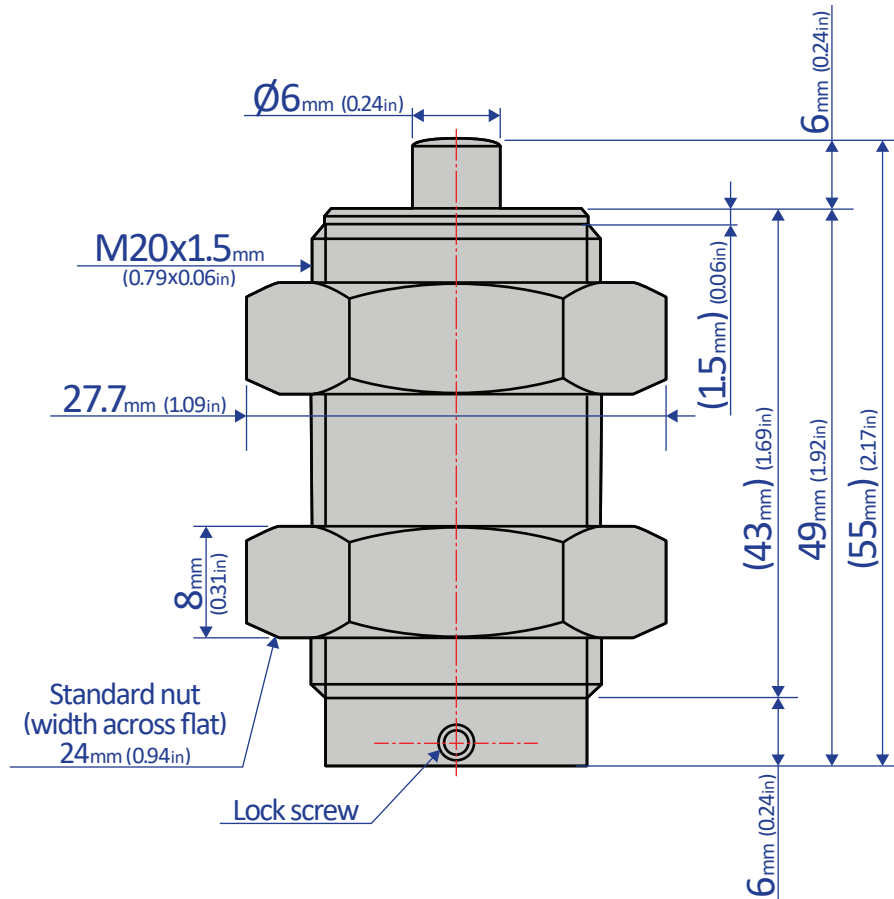

Turn the slotted-driver groove to desired position

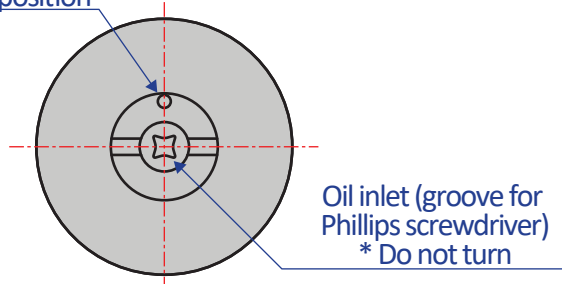

Bansbach
easylift[®]

50 West Drive • Melbourne, Florida 32904
(321) 253-1999 • www.easylift.com • www.damper.net