

CPD65-BAV45

Low Leakage Diode Die

50mA, 35 Volt

The CPD65-BAV45 is a silicon 50mA, 35 Volt diode ideal for low leakage applications.

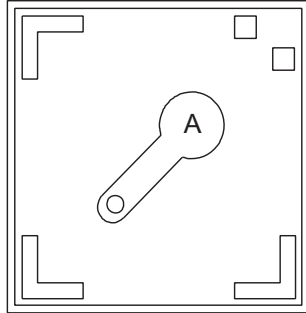

BACKSIDE CATHODE R0

MECHANICAL SPECIFICATIONS:

Die Size	11.8 x 11.8 MILS
Die Thickness	8.0 MILS
Anode Bonding Pad Size	2.35 MILS DIAMETER
Top Side Metalization	Al – 15,000Å
Back Side Metalization	Au – 18,000Å
Scribe Alley Width	2.5 MILS
Wafer Diameter	4 INCHES
Gross Die Per Wafer	75,000

MAXIMUM RATINGS: ($T_A=25^\circ\text{C}$)

	SYMBOL		UNITS
Peak Repetitive Reverse Voltage	V_{RRM}	35	V
Continuous Reverse Voltage	V_R	20	V
Continuous Forward Current	I_F	50	mA
Peak Repetitive Forward Current	I_{FRM}	100	mA
Operating and Storage Junction Temperature	T_J, T_{stg}	-65 to +125	$^\circ\text{C}$

ELECTRICAL CHARACTERISTICS: ($T_A=25^\circ\text{C}$ unless otherwise noted)

SYMBOL	TEST CONDITIONS	MIN	MAX	UNITS
I_R	$V_R=5.0\text{V}$		5.0	pA
I_R	$V_R=20\text{V}$		10	pA
V_F	$I_F=10\text{mA}$		1.0	V
C_J	$V_R=0, f=1.0\text{MHz}$		1.3	pF
t_{rr}	$I_F=I_R=10\text{mA}, I_{rr}=1.0\text{mA}, R_L=100\Omega$		600	ns

CPD65-BAV45

Typical Electrical Characteristics

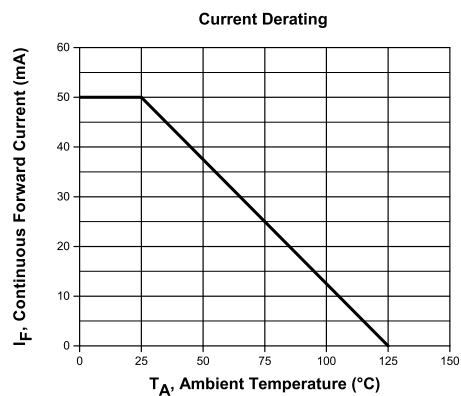
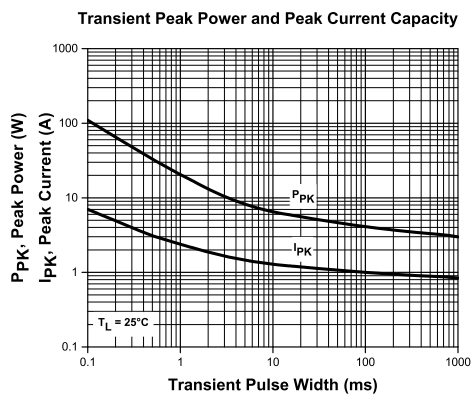
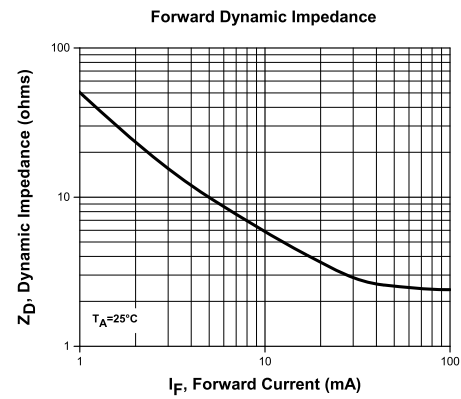
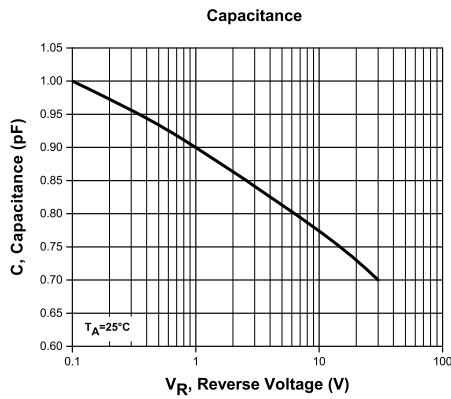
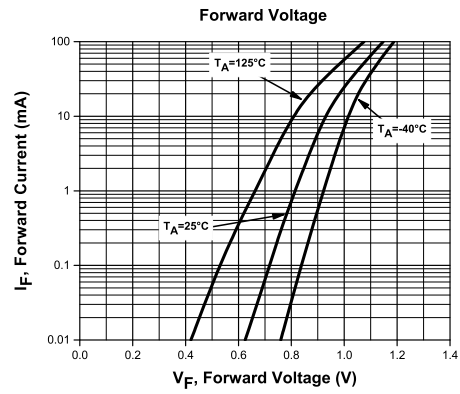
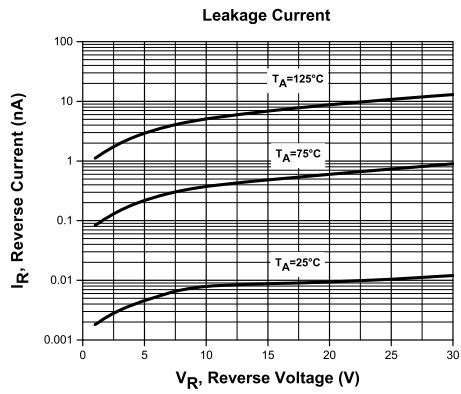

BARE DIE PACKING OPTIONS



BARE DIE IN TRAY (WAFFLE) PACK

CT: Singulated die in tray (waffle) pack.
(example: CP211-PART NUMBER-CT)

CM: Singulated die in tray (waffle) pack 100% visually inspected as per MIL-STD-750, (method 2072 transistors, method 2073 diodes).
(example: CP211-PART NUMBER-CM)



UNSAWN WAFER

WN: Full wafer, unsawn, 100% tested with reject die inked.
(example: CP211-PART NUMBER-WN)



SAWN WAFER ON PLASTIC RING

WR: Full wafer, sawn and mounted on plastic ring,
100% tested with reject die inked.
(example: CP211-PART NUMBER-WR)

Please note: Sawn Wafer on Metal Frame (WS) is possible as a special order. Please contact your Central Sales Representative at 631-435-1110.

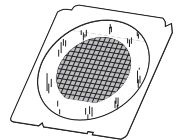

Visit the Central website for a complete listing of specifications:
www.centrasemi.com/bdspecs

OUTSTANDING SUPPORT AND SUPERIOR SERVICES



PRODUCT SUPPORT

Central's operations team provides the highest level of support to insure product is delivered on-time.

- Supply management (Customer portals)
- Inventory bonding
- Consolidated shipping options
- Custom bar coding for shipments
- Custom product packing

DESIGNER SUPPORT/SERVICES

Central's applications engineering team is ready to discuss your design challenges. Just ask.

- Free quick ship samples (2nd day air)
- Online technical data and parametric search
- SPICE models
- Custom electrical curves
- Environmental regulation compliance
- Customer specific screening
- Up-screening capabilities
- Special wafer diffusions
- PbSn plating options
- Package details
- Application notes
- Application and design sample kits
- Custom product and package development

REQUESTING PRODUCT PLATING

1. If requesting Tin/Lead plated devices, add the suffix " TIN/LEAD" to the part number when ordering (example: 2N2222A TIN/LEAD).
2. If requesting Lead (Pb) Free plated devices, add the suffix " PBFREE" to the part number when ordering (example: 2N2222A PBFREE).

CONTACT US

Corporate Headquarters & Customer Support Team

Central Semiconductor Corp.
145 Adams Avenue
Hauppauge, NY 11788 USA
Main Tel: (631) 435-1110
Main Fax: (631) 435-1824
Support Team Fax: (631) 435-3388
www.centrasemi.com

Worldwide Field Representatives:
www.centrasemi.com/wwreps

Worldwide Distributors:
www.centrasemi.com/wwdistributors

For the latest version of Central Semiconductor's **LIMITATIONS AND DAMAGES DISCLAIMER**, which is part of Central's Standard Terms and Conditions of sale, visit: www.centrasemi.com/terms



<http://www.centrasemi.com>

Product End of Life Notification

PDN ID:	PDN01138
Notification Date:	1/20/20
Last Buy Date:	7/20/20
Last Shipment Date	1/20/21

Summary: The CPD65 die process is discontinued and now classified as End of (EOL).

Although Central Semiconductor Corp. makes every effort to continue to produce devices that have been proclaimed EOL (End of Life) by other manufacturers, it is an accepted industry practice to discontinue certain devices when customer demand falls below a minimum level of sustainability. Accordingly, the following product(s) have been transitioned to End of Life status as part of Central's ongoing Product Management Process. Any replacement products are noted below. The effective date for placing last purchase orders will be six (6) months from the date of this notice and twelve (12) months from the notice date for final shipments, and minimum order quantities may apply. The last purchase and shipment dates may be extended if inventory is available.

<u>Central Part Number</u>	<u>Replacement</u>
CPD65-BAV45-CM	N/A, Stock Only
CPD65-BAV45-CT	N/A, Stock Only
CPD65-BAV45-WN	N/A, Stock Only

Central would be happy to assist you by providing additional information or technical data to help locate an alternate source if we have no replacement available. Please email your requests to engineering@centrasemi.com.

DISCLAIMER: This End of Life (EOL) notification is in accordance with JEDEC standard JESD48 - Product Discontinuance. Central Semiconductor Corp. will make every effort to offer life-time buy (LTB) opportunities and/or offer replacement devices to existing customers for discontinued devices, however, one or both may not be possible for all devices. Please contact your local Central Semiconductor sales representative for LTB opportunities/additional information.