

CUTE-3-SS

~12° smooth spot beam with 3 mm high location pins

SPECIFICATION:

Dimensions	Ø 35.0 mm
Height	15 mm
Fastening	glue, pin
ROHS compliant	yes ⓘ



MATERIALS:

Component	Type	Material	Colour	Finish
CUTE-3-SS	Multi-lens	PMMA	clear	

ORDERING INFORMATION:

Component	Qty in box	MOQ	MPQ	Box weight (kg)
C10754_CUTE-3-SS » Box size: 480 x 280 x 300 mm	630	90	45	6.9

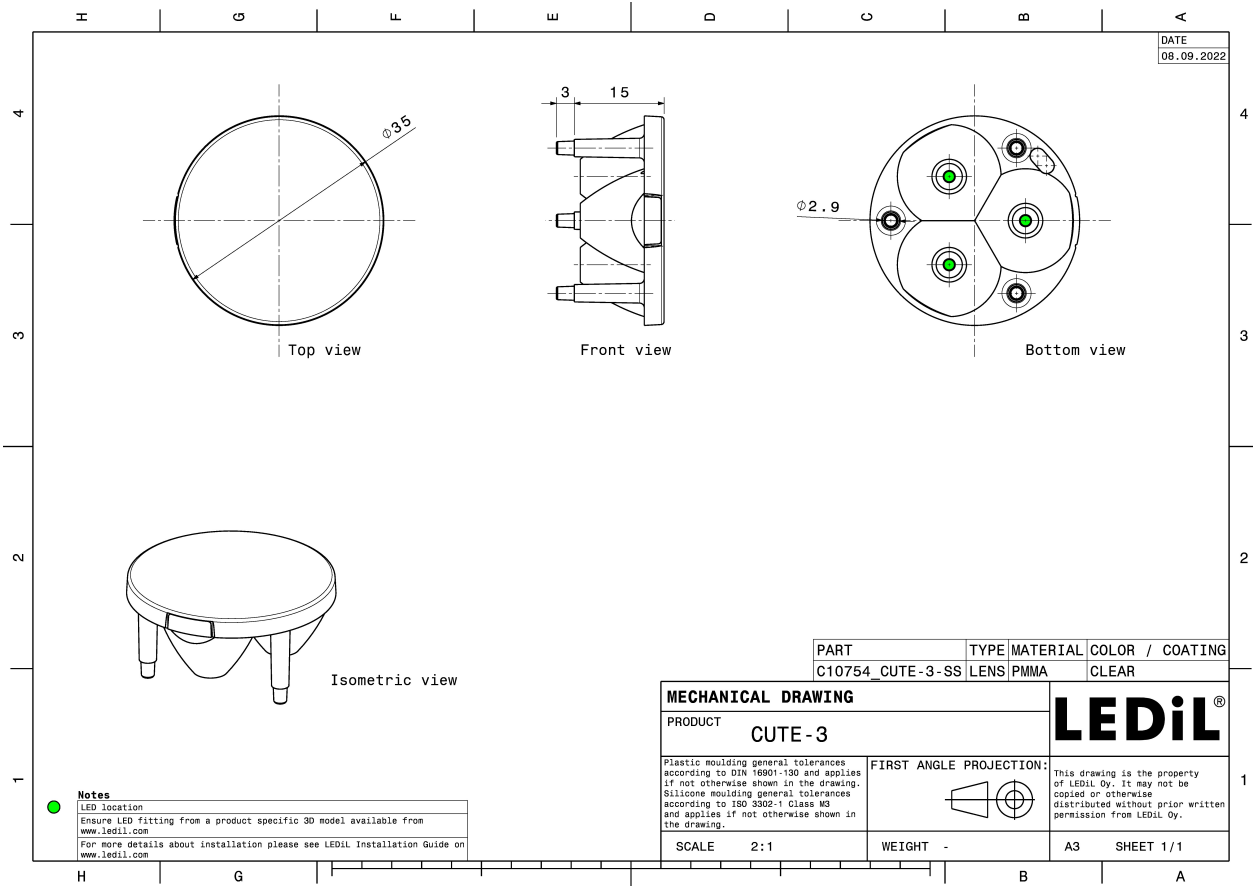

See also our general installation guide: www.ledil.com/installation_guide

OPTICAL RESULTS (MEASURED):

CREE LED

LED XM-L
 FWHM / FWTM 19.0° / 38.0°
 Efficiency 91 %
 Peak intensity 5.3 cd/lm
 LEDs/each optic 1
 Light colour White
 Required components:

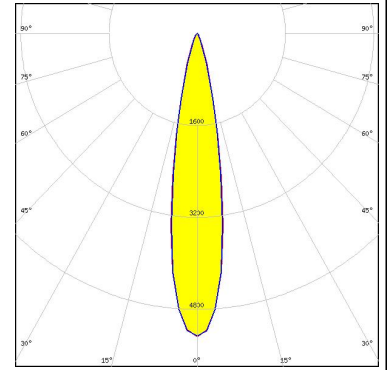

CREE LED

LED XM-L2
 FWHM / FWTM 20.0° / 37.0°
 Efficiency 90 %
 Peak intensity 6.4 cd/lm
 LEDs/each optic 1
 Light colour White
 Required components:

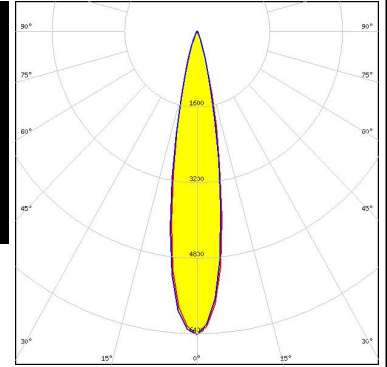

CREE LED

LED XP-E
 FWHM / FWTM 11.0° / 21.0°
 Efficiency 93 %
 Peak intensity 15.4 cd/lm
 LEDs/each optic 1
 Light colour White
 Required components:

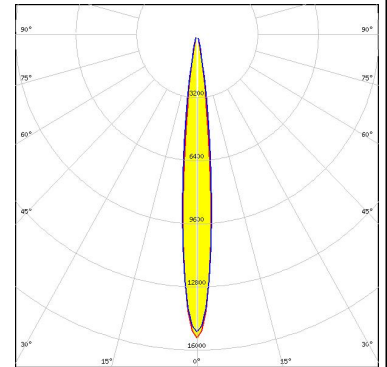

CREE LED

LED XP-G
 FWHM / FWTM 15.0° / 28.0°
 Efficiency 93 %
 Peak intensity 9.5 cd/lm
 LEDs/each optic 1
 Light colour White
 Required components:

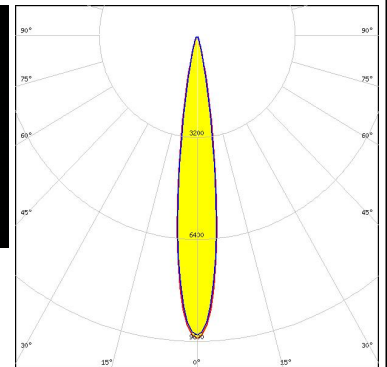

OPTICAL RESULTS (MEASURED):

CREE LED

LED XP-G2
 FWHM / FWTM 14.0° / 27.0°
 Efficiency 94 %
 Peak intensity 10.3 cd/lm
 LEDs/each optic 1
 Light colour White
 Required components:

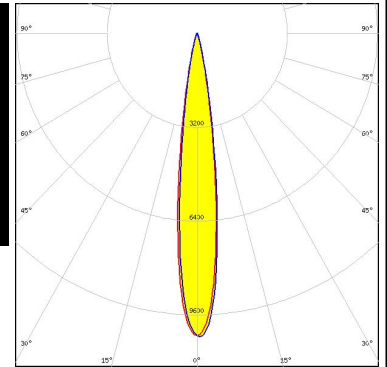

CREE LED

LED XP-G2 HE
 FWHM / FWTM 17.0° / 33.0°
 Efficiency 96 %
 Peak intensity 7.8 cd/lm
 LEDs/each optic 1
 Light colour White
 Required components:

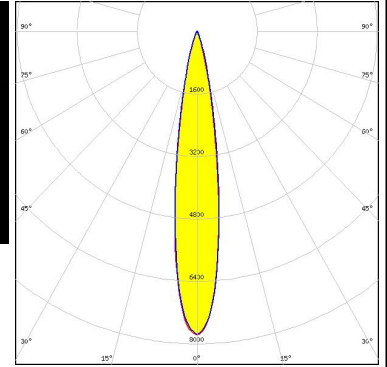

CREE LED

LED XT-E
 FWHM / FWTM 12.0° / 28.0°
 Efficiency 88 %
 Peak intensity 8.7 cd/lm
 LEDs/each optic 1
 Light colour White
 Required components:

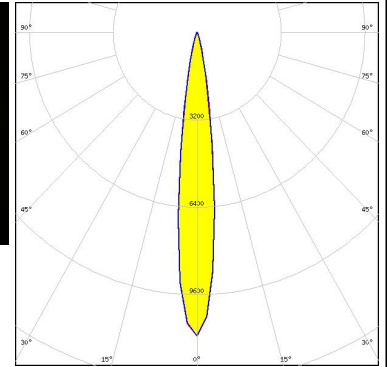

LUMILEDS

LED LUXEON A
 FWHM / FWTM 13.0°
 Efficiency 91 %
 LEDs/each optic 1
 Light colour White
 Required components:

OPTICAL RESULTS (MEASURED):

LUMILEDS

LED LUXEON Rebel
FWHM / FWTM 12.0° / 23.0°
Efficiency 91 %
Peak intensity 12.2 cd/lm
LEDs/each optic 1
Light colour White
Required components:

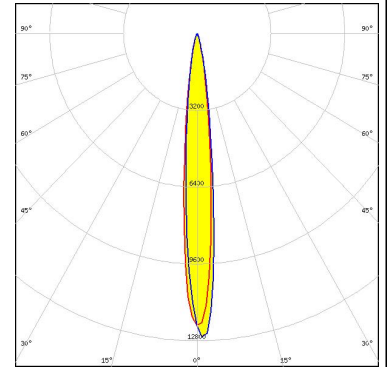

LUMILEDS

LED LUXEON Rebel ES
FWHM / FWTM 13.0°
Efficiency 91 %
LEDs/each optic 1
Light colour White
Required components:

NICHIA

LED NCSxx19A
FWHM / FWTM 12.0°
Efficiency 89 %
LEDs/each optic 1
Light colour White
Required components:

NICHIA

LED NVSxx19A
FWHM / FWTM 13.0° / 29.0°
Efficiency 94 %
Peak intensity 9.2 cd/lm
LEDs/each optic 1
Light colour White
Required components:

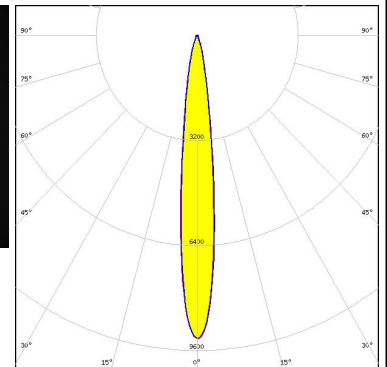
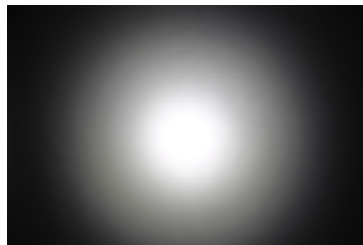

OPTICAL RESULTS (MEASURED):

OSRAM

Opto Semiconductors

LED OSLON Square EC
 FWHM / FWTM 17.0° / 32.0°
 Efficiency 83 %
 Peak intensity 8.5 cd/lm
 LEDs/each optic 1
 Light colour White
 Required components:

OSRAM

Opto Semiconductors

LED OSLON SSL 150
 FWHM / FWTM 13.0°
 Efficiency %
 LEDs/each optic 1
 Light colour White
 Required components:

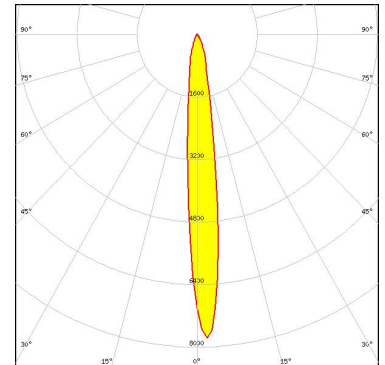

OSRAM

Opto Semiconductors

LED OSLON SSL 80
 FWHM / FWTM 10.0° / 22.0°
 Efficiency 90 %
 Peak intensity 15.2 cd/lm
 LEDs/each optic 1
 Light colour White
 Required components:

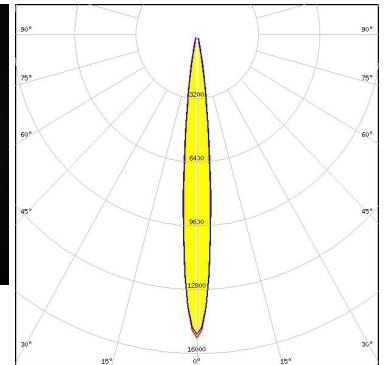

SEOUL SEMICONDUCTOR

SEOUL SEMICONDUCTOR

LED Z5
 FWHM / FWTM 10.0°
 Efficiency %
 LEDs/each optic 1
 Light colour White
 Required components:



OPTICAL RESULTS (MEASURED):

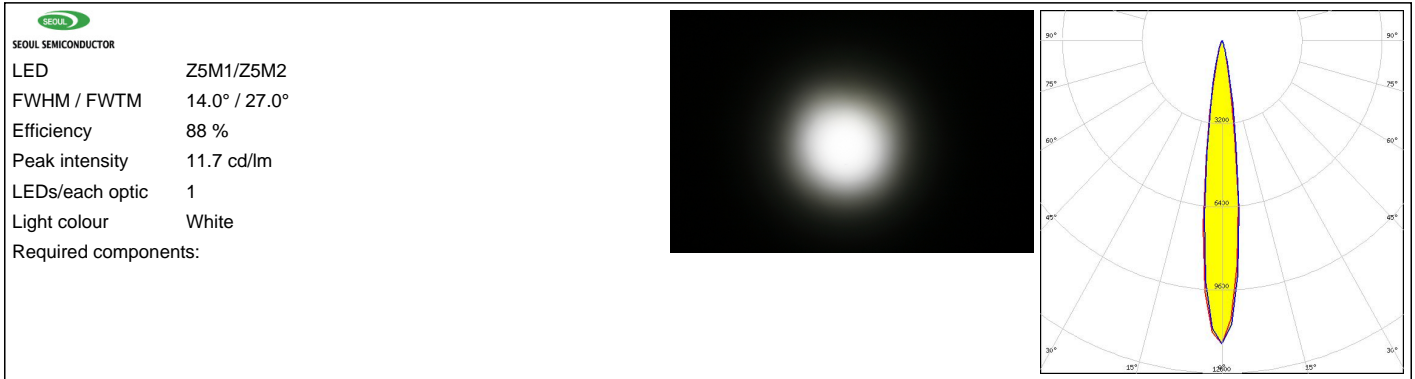

OPTICAL RESULTS (SIMULATED):



LED XM-L HVW
 FWHM / FWTM 19.0°
 Efficiency %
 LEDs/each optic 1
 Light colour White
 Required components:



LED XP-E2
 FWHM / FWTM 10.0° / 21.0°
 Efficiency 95 %
 Peak intensity 19.1 cd/lm
 LEDs/each optic 1
 Light colour White
 Required components:

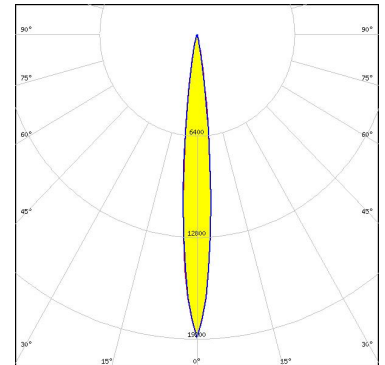

LED XT-E HVW
 FWHM / FWTM 15.0°
 Efficiency %
 LEDs/each optic 1
 Light colour White
 Required components:



LED LUXEON IR Domed 60
 FWHM / FWTM 13.0° / 29.0°
 Efficiency 94 %
 Peak intensity 10.2 cd/lm
 LEDs/each optic 1
 Light colour IR
 Required components:

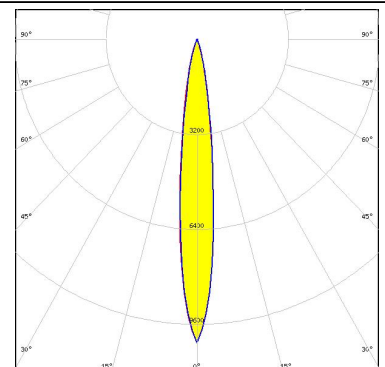

OPTICAL RESULTS (SIMULATED):

SAMSUNG

LED	LH351B
FWHM / FWTM	16.0° / 30.0°
Efficiency	95 %
Peak intensity	8.8 cd/lm
LEDs/each optic	1
Light colour	White
Required components:	

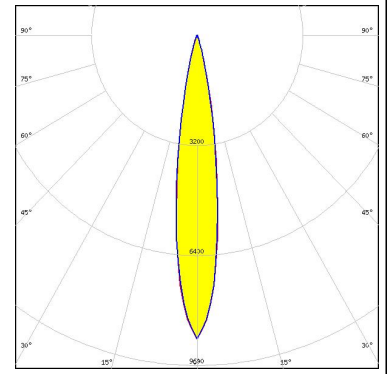

GENERAL INFORMATION:

NOTE: The typical beam angle will be changed by different color, chip size and chip position tolerance. The typical total beam angle is the full angle measured where the luminous intensity is half of the peak value.

MATERIALS:

As part of our continuous research and improvement processes, and to ensure the best possible quality and availability of our products, LEDiL reserves the right to change material grades without notice.

PRODUCT DATA USER AGREEMENT AND DISCLAIMER:

The measured data in the provided downloadable LEDiL Product Datasheets and Mechanical 2D-Drawings is rounded and provided as reference for planning. LEDiL Oy's optical specifications have been verified by conducting performance testing of the products in accordance with the company's quality system. The reported data are averaged results of multiple measurements with typical variation. LEDiL Oy reserves the right to without prior notification make changes and improvements to its products.

LEDiL Oy assumes neither warranty, nor guarantee nor any other liability of any kind for the contents and correctness of the provided data. The provided data has been generated with highest diligence but the provided data may in reality not represent the complete possible variation range of all intrinsic parameters. Therefore, in certain cases a deviation from the provided data could occur.

LEDiL Oy reserves the right to undertake technical changes of its products without further notification which could lead to changes in the provided data. LEDiL Oy assumes no liability of any kind for the possible deviation from any provided data or any other damage resulting from the usage of the provided data.

The user agrees to this disclaimer and user agreement with the download or usage of the provided files.

LEDiL Oy

Joensuunkatu 13
FI-24240 SALO
Finland

LEDiL Inc.

228 West Page Street
Suite D
Sycamore IL 60178
USA

Ledil Optics Technology (Shenzhen) Co., Ltd.

405 , Block B
Casic Motor Building
Shenzhen 518057
P.R.CHINA

Local sales and technical support

[www.ledil.com/
where_to_buy](http://www.ledil.com/where_to_buy)

Shipping locations

Salo, Finland
Hong Kong, China

Distribution Partners

[www.ledil.com/
where_to_buy](http://www.ledil.com/where_to_buy)