

## Data sheet | Item number: 285-935

2-conductor through terminal block; 35 mm<sup>2</sup>; suitable for Ex e II applications; lateral marker slots; only for DIN 35 x 15 rail; POWER CAGE CLAMP; 35,00 mm<sup>2</sup>; light gray

[www.wago.com/285-935](http://www.wago.com/285-935)

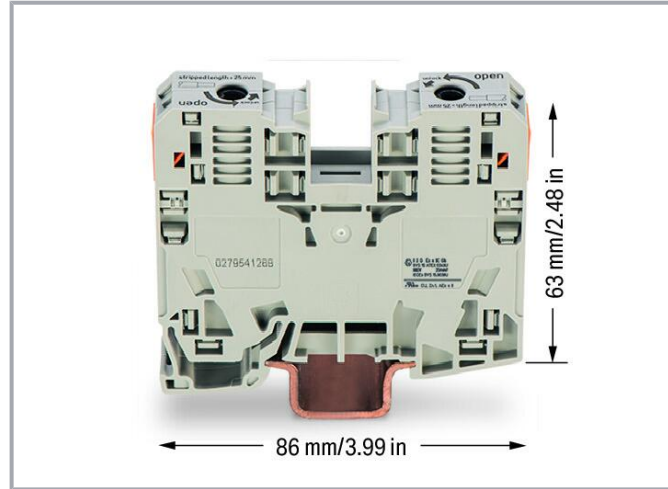

### Data

#### Electrical data

#### Ratings per IEC/EN

Ratings per

IEC/EN 60947-7-1

#### Ratings per UL 1059

Approvals per	UL 1059
Rated voltage UL (Use Group B)	600 V
Rated current UL (Use Group B)	115 A
Rated voltage UL (Use Group C)	600 V
Rated current UL (Use Group C)	115 A

Subject to changes. Please also observe the further product documentation!

WAGO GmbH & Co. KG  
Hansastr. 27  
32423 Minden  
Phone: +49571 887-0 | Fax: +49571 887-169  
Email: [info.de@wago.com](mailto:info.de@wago.com) | Web: [www.wago.com](http://www.wago.com)

Do you have any questions about our products?  
We are always happy to take your call at +49 (571) 887-44222.



## Ratings per CSA

Approvals per	CSA 22.2 No 158
Rated voltage CSA (Use Group B)	600 V
Rated current CSA (Use Group B)	115 A
Rated voltage CSA (Use Group D)	600 V
Rated current CSA (Use Group D)	115 A

## Ex information

Reference hazardous areas	See "Downloads – Documentation – Additional Information: Technical Section; Technical Explications"
Ratings per	ATEX: PTB 98 ATEX 3134 U (Ex eb IIC Gb)
Rated voltage EN (Ex e II)	880 V
Rated current (Ex e II)	101 A
Rated current (Ex e II) with jumper	75 A

## Power loss

Power loss, per pole (potential)	2.652 W
Rated current $I_N$ for specified power loss	101 A
Resistance value for specified, current-dependent power loss	0 $\Omega$

## Connection data

Connection points	2
Total number of potentials	1
Number of levels	1
Number of jumper slots	2

## Connection 1

Connection technology	POWER CAGE CLAMP
Actuation type	Operating tool
Connectable conductor materials	Copper
Solid conductor	6 ... 35 mm <sup>2</sup> / 8 ... 2 AWG
Stranded conductor	6 ... 35 mm <sup>2</sup> / 8 ... 2 AWG
Fine-stranded conductor	6 ... 35 mm <sup>2</sup> / 8 ... 2 AWG
Fine-stranded conductor; with insulated ferrule	6 ... 35 mm <sup>2</sup> / 8 ... 2 AWG
Fine-stranded conductor; with uninsulated ferrule	6 ... 35 mm <sup>2</sup> / 8 ... 2 AWG

Subject to changes. Please also observe the further product documentation!



Strip length	25 mm / 0.98 inches
Wiring direction	Side-entry wiring

### Physical data

Width	16 mm / 0.63 inches
Height	86 mm / 3.386 inches
Depth from upper-edge of DIN-rail	63 mm / 2.48 inches

### Mechanical Data

Mounting type	DIN-rail 35 x 15
Mounting (note)	only suitable for DIN 35 x 15 rail
Marking level	Side marking

### Material Data

Note (material data)	Information on material specifications can be found here
Color	light gray
Material group	I
Insulation material	Polyamide (PA66)
Flammability class per UL94	V0
Fire load	0.687 MJ
Weight	79.3 g

### Environmental requirements

Processing temperature	-35 ... +85 °C
Continuous operating temperature	-60 ... +105 °C

### Commercial data

eCl@ss 10.0	27-14-11-20
eCl@ss 9.0	27-14-11-20
ETIM 8.0	EC000897
ETIM 7.0	EC000897
PU (SPU)	15 pcs
Packaging type	box
Country of origin	PL
GTIN	4055143418539

Subject to changes. Please also observe the further product documentation!

WAGO GmbH & Co. KG  
 Hansastr. 27  
 32423 Minden  
 Phone: +49571 887-0 | Fax: +49571 887-169  
 Email: [info.de@wago.com](mailto:info.de@wago.com) | Web: [www.wago.com](http://www.wago.com)

Do you have any questions about our products?  
 We are always happy to take your call at +49 (571) 887-44222.





Customs tariff number	85369010000
-----------------------	-------------

## Environmental Product Compliance



RoHS Compliance Status	Compliant, No Exemption
------------------------	-------------------------

## Approvals / Certificates

### General approvals

Logo	Approval	Additional Approval Text	Certificate name
	CCA DEKRA Certification B.V.	EN 60947	NTR NL-7707
	CCC CNEX	GB/T 3836.3	2020312313000177 (Ex eb IIC Gb, Ex eb I Mb)
	CSA DEKRA Certification B.V.	C22.2 No. 158	154112
	UL Underwriters Laboratories Inc.	UL 1059	E45172

### Declarations of conformity and manufacturer's declarations

Logo	Approval	Additional Approval Text	Certificate name
	EU-Declaration of Conformity WAGO GmbH & Co. KG	-	-
	UK-Declaration of Conformity WAGO GmbH & Co. KG	-	-

### Approvals for hazardous areas

Logo	Approval	Additional Approval Text	Certificate name
	AEx Underwriters Laboratories Inc.	-	E185892 (AEx eb II C resp. Ex eb II C)

Subject to changes. Please also observe the further product documentation!



# AEx

	ATEX Physikalisch Technische Bundesanstalt	EN 60079-0	PTB 98 ATEX 3134 U (II 2 G Ex eb IIC Gb or I M 2 Ex eb I Mb)
	CCC CNEX	GB/T 3836.3	2020312313000177 (Ex eb IIC Gb, Ex eb I Mb)
	EAC Brjansker Zertifizierungsstelle	TP TC 012/2011	RU C-DE.AM02.B. 00127/19 (Ex e IIC Gb U)
	IECEX Physikalisch Technische Bundesanstalt	IEC 60079-0	IECEX PTB 16.0001U (Ex eb IIC Gb or Ex eb I Mb)

## Optional accessories



### Voltage tap

#### Power tap

	<b>Item no.: 283-407</b> Power tap; with 500 mm cable; for 16 mm <sup>2</sup> (283/783 Series) and 35 mm <sup>2</sup> ; gray	<a href="http://www.wago.com/283-407">www.wago.com/283-407</a>
	<b>Item no.: 285-427</b> Power tap; for 35 mm <sup>2</sup> high-current tbs; Module width 8 mm; 6,00 mm <sup>2</sup> ; gray	<a href="http://www.wago.com/285-427">www.wago.com/285-427</a>

### Carrier rail

#### Mounting accessories

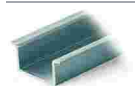
	<b>Item no.: 210-197</b> Steel carrier rail; 35 x 15 mm; 1.5 mm thick; 2 m long; slotted; similar to EN 60715; silver-colored	<a href="http://www.wago.com/210-197">www.wago.com/210-197</a>
	<b>Item no.: 210-198</b> Copper carrier rail; 35 x 15 mm; 2.3 mm thick; 2 m long; unslotted; according to EN 60715; copper-colored	<a href="http://www.wago.com/210-198">www.wago.com/210-198</a>
	<b>Item no.: 210-506</b> Steel carrier rail; 35 x 15 mm; 1.5 mm thick; 2 m long; unslotted; galvanized; similar to EN 60715; silver-colored	<a href="http://www.wago.com/210-506">www.wago.com/210-506</a>
	<b>Item no.: 210-508</b>	

Subject to changes. Please also observe the further product documentation!



Steel carrier rail; 35 x 15 mm; 1.5 mm thick; 2 m long; slotted; galvanized; similar to EN 60715; silver-colored

[www.wago.com/210-508](http://www.wago.com/210-508)



**Item no.: 210-118**

Steel carrier rail; 35 x 15 mm; 2.3 mm thick; 2 m long; unslotted; according to EN 60715; silver-colored

[www.wago.com/210-118](http://www.wago.com/210-118)



**Item no.: 210-114**

Steel carrier rail; 35 x 15 mm; 1.5 mm thick; 2 m long; unslotted; similar to EN 60715; silver-colored

[www.wago.com/210-114](http://www.wago.com/210-114)

## Jumpers

Jumper



**Item no.: 285-435**

Jumper; insulated; gray

[www.wago.com/285-435](http://www.wago.com/285-435)

## Protective warning marker

Cover



**Item no.: 285-420**

Protective warning marker; with high-voltage symbol, black; yellow

[www.wago.com/285-420](http://www.wago.com/285-420)

## Mounting

Mounting accessories



**Item no.: 249-117**

Screwless end stop; 10 mm wide; for DIN-rail 35 x 15 and 35 x 7.5; gray

[www.wago.com/249-117](http://www.wago.com/249-117)



**Item no.: 249-197**

Screwless end stop; 14 mm wide; for DIN-rail 35 x 15 and 35 x 7.5; gray

[www.wago.com/249-197](http://www.wago.com/249-197)

## Ferrule

Ferrule



**Item no.: 216-413**

Ferrule; Sleeve for 25 mm<sup>2</sup> / AWG 4; uninsulated; electro-tin plated; electrolytic copper; gastight crimped; acc. to DIN 46228, Part 1/08.92; silver-colored

[www.wago.com/216-413](http://www.wago.com/216-413)



**Item no.: 216-414**

Ferrule; Sleeve for 35 mm<sup>2</sup> / AWG 2; uninsulated; electro-tin plated; electrolytic copper; gastight crimped; acc. to DIN 46228, Part 1/08.92; silver-colored

[www.wago.com/216-414](http://www.wago.com/216-414)

## Marking accessories

Marking strip



**Item no.: 2009-110**

Marking strips; for Smart Printer; on reel; not stretchable; plain; snap-on type; white

[www.wago.com/2009-110](http://www.wago.com/2009-110)

Marker carrier

Subject to changes. Please also observe the further product documentation!

WAGO GmbH & Co. KG

Hansastr. 27

32423 Minden

Phone: +49571 887-0 | Fax: +49571 887-169

Email: [info.de@wago.com](mailto:info.de@wago.com) | Web: [www.wago.com](http://www.wago.com)

Do you have any questions about our products?

We are always happy to take your call at +49 (571) 887-44222.



**Item no.: 285-442**  
Adaptor; gray

[www.wago.com/285-442](http://www.wago.com/285-442)

Marker



**Item no.: 2009-115/000-002**  
WMB-Inline; for Smart Printer; 1500 pieces on roll; stretchable 5 - 5.2 mm; plain; snap-on type; yellow

[www.wago.com/2009-115/000-002](http://www.wago.com/2009-115/000-002)



**Item no.: 2009-115/000-007**  
WMB-Inline; for Smart Printer; 1500 pieces on roll; stretchable 5 - 5.2 mm; plain; snap-on type; gray

[www.wago.com/2009-115/000-007](http://www.wago.com/2009-115/000-007)



**Item no.: 2009-115/000-017**  
WMB-Inline; for Smart Printer; 1500 pieces on roll; stretchable 5 - 5.2 mm; plain; snap-on type; light green

[www.wago.com/2009-115/000-017](http://www.wago.com/2009-115/000-017)



**Item no.: 2009-115/000-023**  
WMB-Inline; for Smart Printer; 1500 pieces on roll; stretchable 5 - 5.2 mm; plain; snap-on type; green

[www.wago.com/2009-115/000-023](http://www.wago.com/2009-115/000-023)



**Item no.: 2009-115/000-024**  
WMB-Inline; for Smart Printer; 1500 pieces on roll; stretchable 5 - 5.2 mm; plain; snap-on type; violet

[www.wago.com/2009-115/000-024](http://www.wago.com/2009-115/000-024)



**Item no.: 2009-115**  
WMB-Inline; for Smart Printer; 1500 pieces on roll; stretchable 5 - 5.2 mm; plain; snap-on type; white

[www.wago.com/2009-115](http://www.wago.com/2009-115)



**Item no.: 793-5501/000-007**  
WMB marking card; as card; for terminal block width 5 - 17.5 mm; stretchable 5 - 5.2 mm; plain; snap-on type; gray

[www.wago.com/793-5501/000-007](http://www.wago.com/793-5501/000-007)



**Item no.: 793-5501/000-012**  
WMB marking card; as card; for terminal block width 5 - 17.5 mm; stretchable 5 - 5.2 mm; plain; snap-on type; orange

[www.wago.com/793-5501/000-012](http://www.wago.com/793-5501/000-012)



**Item no.: 793-5501/000-014**  
WMB marking card; as card; for terminal block width 5 - 17.5 mm; stretchable 5 - 5.2 mm; plain; snap-on type; brown

[www.wago.com/793-5501/000-014](http://www.wago.com/793-5501/000-014)



**Item no.: 793-5501/000-017**  
WMB marking card; as card; for terminal block width 5 - 17.5 mm; stretchable 5 - 5.2 mm; plain; snap-on type; light green

[www.wago.com/793-5501/000-017](http://www.wago.com/793-5501/000-017)

**Item no.: 793-5501/000-023**

Subject to changes. Please also observe the further product documentation!



WMB marking card; as card; for terminal block width 5 - 17.5 mm; stretchable 5 - 5.2 mm; plain; snap-on type; green [www.wago.com/793-5501/000-023](http://www.wago.com/793-5501/000-023)



**Item no.: 793-5501/000-024**  
WMB marking card; as card; for terminal block width 5 - 17.5 mm; stretchable 5 - 5.2 mm; plain; snap-on type; violet [www.wago.com/793-5501/000-024](http://www.wago.com/793-5501/000-024)



**Item no.: 793-501/000-002**  
WMB marking card; as card; not stretchable; plain; snap-on type; yellow [www.wago.com/793-501/000-002](http://www.wago.com/793-501/000-002)



**Item no.: 793-501/000-007**  
WMB marking card; as card; not stretchable; plain; snap-on type; gray [www.wago.com/793-501/000-007](http://www.wago.com/793-501/000-007)



**Item no.: 793-501/000-017**  
WMB marking card; as card; not stretchable; plain; snap-on type; light green [www.wago.com/793-501/000-017](http://www.wago.com/793-501/000-017)



**Item no.: 793-501/000-012**  
WMB marking card; as card; not stretchable; plain; snap-on type; orange [www.wago.com/793-501/000-012](http://www.wago.com/793-501/000-012)



**Item no.: 793-501/000-023**  
WMB marking card; as card; not stretchable; plain; snap-on type; green [www.wago.com/793-501/000-023](http://www.wago.com/793-501/000-023)



**Item no.: 793-501/000-006**  
WMB marking card; as card; not stretchable; plain; snap-on type; blue [www.wago.com/793-501/000-006](http://www.wago.com/793-501/000-006)



**Item no.: 793-501/000-005**  
WMB marking card; as card; not stretchable; plain; snap-on type; red [www.wago.com/793-501/000-005](http://www.wago.com/793-501/000-005)



**Item no.: 793-501**  
WMB marking card; as card; not stretchable; plain; snap-on type; white [www.wago.com/793-501](http://www.wago.com/793-501)



**Item no.: 793-501/000-024**  
WMB marking card; as card; not stretchable; plain; snap-on type; violet [www.wago.com/793-501/000-024](http://www.wago.com/793-501/000-024)

Subject to changes. Please also observe the further product documentation!





**Item no.:** 793-5501/000-005

WMB marking card; as card; for terminal block width 5 - 17.5 mm; stretchable 5 - 5.2 mm; plain; snap-on type; red [www.wago.com/793-5501/000-005](http://www.wago.com/793-5501/000-005)



**Item no.:** 793-5501/000-002

WMB marking card; as card; for terminal block width 5 - 17.5 mm; stretchable 5 - 5.2 mm; plain; snap-on type; yellow [www.wago.com/793-5501/000-002](http://www.wago.com/793-5501/000-002)



**Item no.:** 793-5501/000-006

WMB marking card; as card; for terminal block width 5 - 17.5 mm; stretchable 5 - 5.2 mm; plain; snap-on type; blue [www.wago.com/793-5501/000-006](http://www.wago.com/793-5501/000-006)



**Item no.:** 793-5501

WMB marking card; as card; for terminal block width 5 - 17.5 mm; stretchable 5 - 5.2 mm; plain; snap-on type; white [www.wago.com/793-5501](http://www.wago.com/793-5501)



**Item no.:** 2009-115/000-012

WMB-Inline; for Smart Printer; 1500 pieces on roll; stretchable 5 - 5.2 mm; plain; snap-on type; orange [www.wago.com/2009-115/000-012](http://www.wago.com/2009-115/000-012)



**Item no.:** 2009-115/000-006

WMB-Inline; for Smart Printer; 1500 pieces on roll; stretchable 5 - 5.2 mm; plain; snap-on type; blue [www.wago.com/2009-115/000-006](http://www.wago.com/2009-115/000-006)



**Item no.:** 2009-115/000-005

WMB-Inline; for Smart Printer; 1500 pieces on roll; stretchable 5 - 5.2 mm; plain; snap-on type; red [www.wago.com/2009-115/000-005](http://www.wago.com/2009-115/000-005)

Group marker carrier



**Item no.:** 249-105

Group marker carrier; gray [www.wago.com/249-105](http://www.wago.com/249-105)

Tool

Operating tool



**Item no.:** 210-721

Operating tool; Blade: 5.5 x 0.8 mm; with a partially insulated shaft; multicoloured [www.wago.com/210-721](http://www.wago.com/210-721)

Cover

Cover



**Item no.:** 285-421

Finger guard; touchproof cover protects unused conductor entries; for 35 mm<sup>2</sup> high-current tbs; yellow [www.wago.com/285-421](http://www.wago.com/285-421)

Downloads

Documentation

Subject to changes. Please also observe the further product documentation!

WAGO GmbH & Co. KG

Hansastr. 27

32423 Minden

Phone: +49571 887-0 | Fax: +49571 887-169

Email: [info.de@wago.com](mailto:info.de@wago.com) | Web: [www.wago.com](http://www.wago.com)

Do you have any questions about our products?

We are always happy to take your call at +49 (571) 887-44222.



### Bid Text

285-935 X81 - Datei	2019 Feb 19	xml 3.3 kB	Download
------------------------	-------------	---------------	----------

285-935 doc - Datei	2018 Jan 4	doc 24.1 kB	Download
------------------------	------------	----------------	----------

### Additional Information

Technical Section Technical explanations		pdf 2.2 MB	Download
---	--	---------------	----------

### CAD/CAE-Data

#### CAE data

EPLAN Data Portal 285-935		URL	Download
---------------------------	--	-----	----------

### Environmental Product Compliance

#### Compliance Search

Environmental Product Compliance 285-935 2-conductor through terminal block; 35 mm <sup>2</sup> ; suitable for Ex e II applications; lateral marker slots; only for DIN 35 x 15 rail; POWER CAGE CLAMP; 35,00 mm <sup>2</sup> ; light gray		URL	Download
---	--	-----	----------

### Installation Notes

#### Installation

Subject to changes. Please also observe the further product documentation!

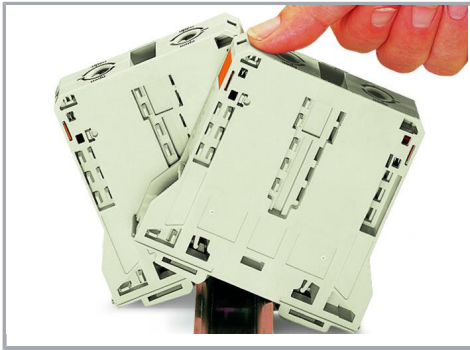

Snapping a terminal block onto DIN-rail (to the left or to the right).



Removing a terminal block from the assembly (to the left or to the right).

### Conductor termination

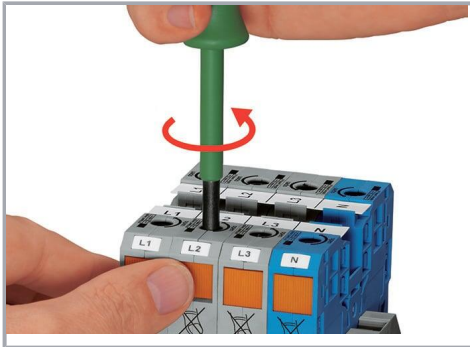

Conductor termination – step 1:

Rotate the operating tool (5.5 mm blade width) counter-clockwise. Next, push in the orange locking tab. The clamp is locked open for hands-free wiring.

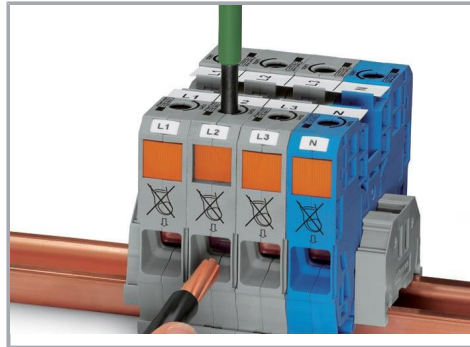

Conductor termination – step 2:

Insert a stripped conductor into the clamping unit until it hits the backstop. Hold in this position.

Subject to changes. Please also observe the further product documentation!

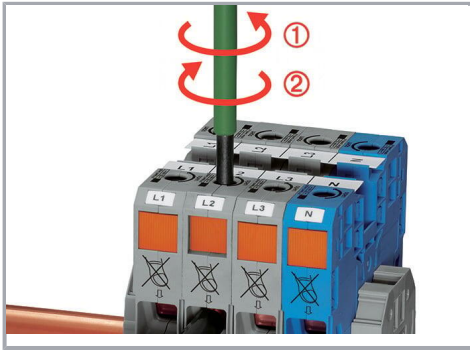

### Conductor termination – step 3:

A short counter-clockwise rotation closes the clamp, securing the conductor. When unlocked, allow the operating tool to rotate clockwise to securely terminate the conductor.

Side-entry wiring means that even larger conductors, which have limited flexibility, can be easily connected.

### Commoning

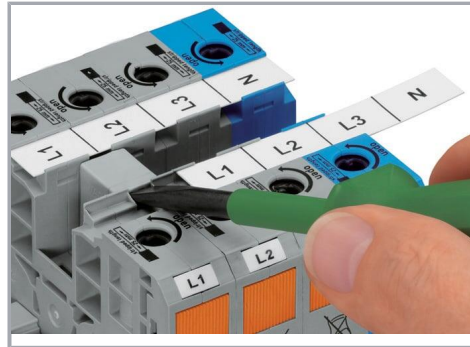
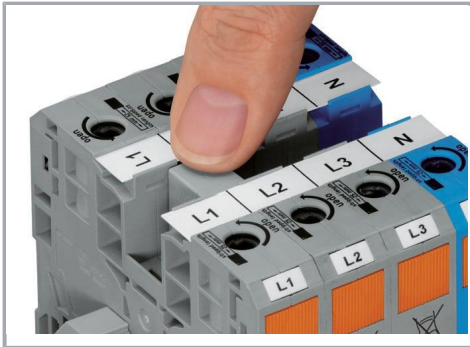

Commoning adjacent terminal blocks using a centrally positioned push-in jumper.

Slide the marking strip laterally to remove the jumper.

### Power tap

Subject to changes. Please also observe the further product documentation!

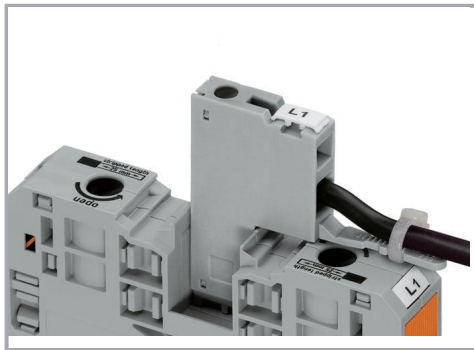

The power tap is inserted into the jumper contact slot. It can be fitted with a strain relief plate.

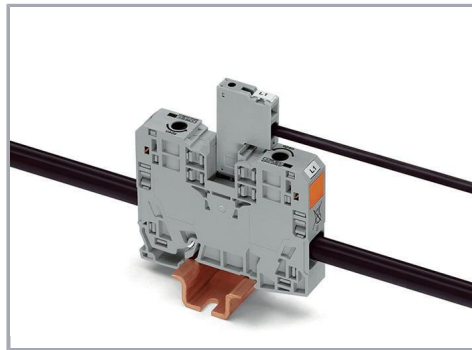

Power tap inserted in a jumper contact slot

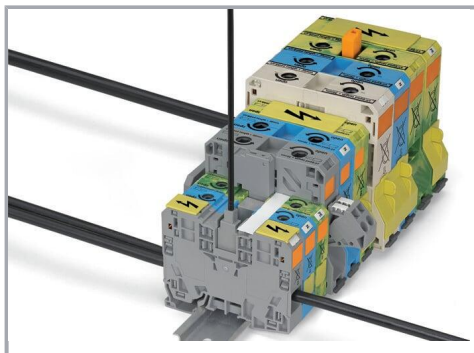

Always push voltage tap (283-407) down into the terminal block until fully inserted!

## Testing

Subject to changes. Please also observe the further product documentation!

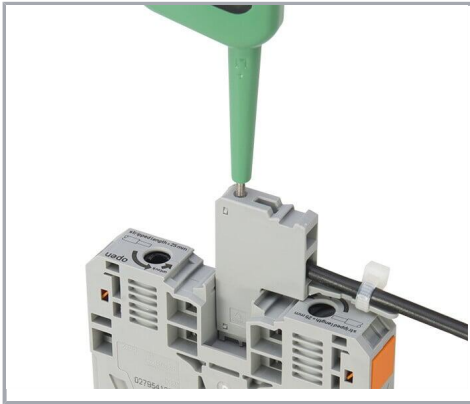

Testing with test plug adapter (283-404).

### Testing

Voltage measurements can be performed, e.g., using a 2-pole voltage tester (206-707).

### Marking

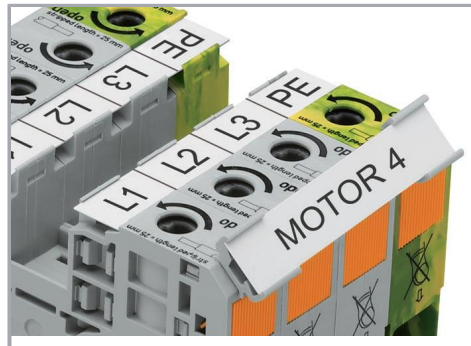
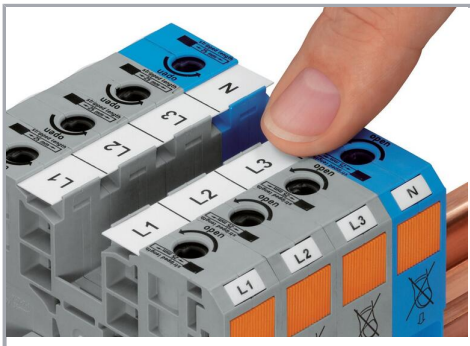

WMB markers or self-adhesive, printable marking strips can be accommodated on 35, 50 and 95 mm<sup>2</sup> high-current terminal blocks.

Marker carrier (285-442) for marking strips (2009-110) or 2 WMB markers for 285-13x, 285-15x and 285-19x Terminal Blocks

Subject to changes. Please also observe the further product documentation!