

SERIES: CP40 | **DESCRIPTION:** PELTIER MODULE**FEATURES**

- arcTEC™ structure on select models
- solid state device
- precise temperature control
- quiet operation

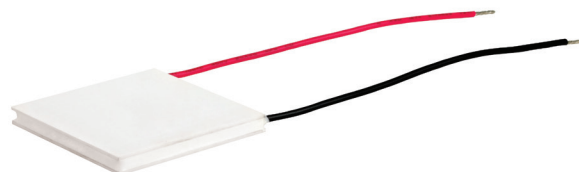

MODEL	input voltage ¹ max (Vdc)	input current ² max (A)	internal resistance ³ typ (Ω±10%)	output Qmax ⁴		output ΔTmax ⁵	
				T _h =27°C (W)	T _h =50°C (W)	T _h =27°C (°C)	T _h =50°C (°C)
CP40136	3.8	4.0	0.80	8.1	9.0	66	72
CP40236	8.6	4.0	2.0	18.7	21.8	66	72
CP40336	15.4	4.0	3.5	33.4	37.3	66	72
CP40147	2.1	4.0	0.42	4.2	4.6	68	75
CP40247	3.8	4.0	0.77	7.5	8.3	68	75
CP402533 ⁶	15.4	4.0	2.88	35.2	39.0	68	75
CP40301547	4.2	4.0	0.87	8.4	9.2	68	75
CP40347 ⁶	8.6	4.0	1.76	19.6	21.6	70	77
CP40439 ⁶	19.5	4.0	4.18	45.0	49.5	68	75
CP404046 ⁶	24.1	4.0	4.94	55.7	61.2	68	75
CP40447 ⁶	15.4	4.0	3.15	32.0	35.2	70	77
CP4055485 ⁶	29.8	4.0	5.97	63.0	69.0	70	77

- Notes:
1. Maximum voltage at ΔT max and T_h=27°C
 2. Maximum current to achieve ΔT max
 3. Measured by AC 4-terminal method at 25°C
 4. Maximum heat absorbed at cold side occurs at I_{max}, V_{max}, and ΔT=0°C
 5. Maximum temperature difference occurs at I_{max}, V_{max}, and Q=0W (ΔT max measured in a vacuum at 1.3 Pa)
 6. Designed with arcTEC™ structure.

SPECIFICATIONS

parameter	conditions/description	min	typ	max	units
solder melting temperature	connection between thermoelectric pairs				
	CP40347, CP40447, CP40147, CP40247, CP402533	235			°C
	CP40301547, CP404046, CP40439, CP4055485	138			°C
assembly compression				1	MPa
RoHS	yes				

MECHANICAL DRAWING

units: mm

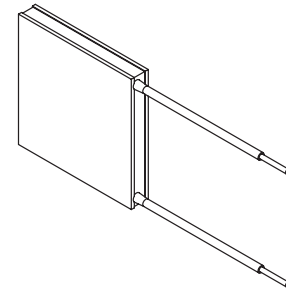
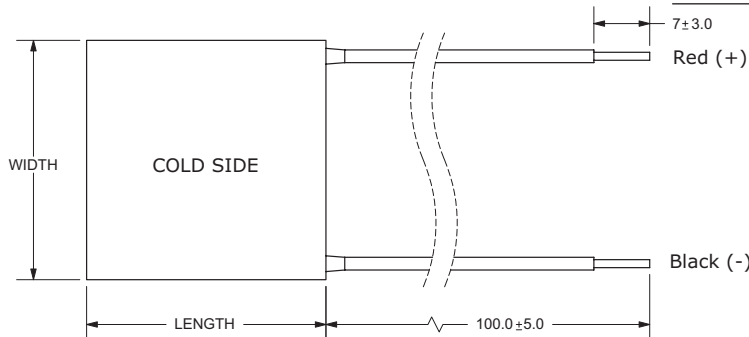
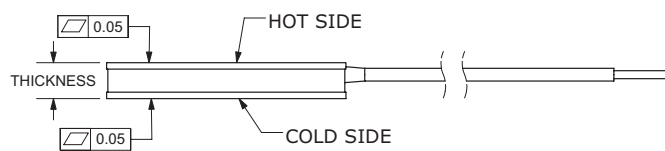

	MATERIAL	PLATING
ceramic plate	96% Al_2O_3	
wire leads (3.3 & 3.6 mm models)	22 AWG	tin
wire leads (all other models)	20 AWG	tin
sealer	silicon rubber 703 RTV (between cold and hot side plates)	
joint cover	silicon rubber 703 RTV	
marking	P/N & S/N printed on cold side surface	

MODEL NO.	LENGTH (mm)	WIDTH (mm)	THICKNESS (mm)
CP40136	15 ± 0.3	15 ± 0.3	3.6 ± 0.1
CP40236	20 ± 0.3	20 ± 0.3	3.6 ± 0.1
CP40336	30 ± 0.3	30 ± 0.3	3.6 ± 0.1
CP40147	15 ± 0.3	15 ± 0.3	4.6 ± 0.1
CP40247	20 ± 0.3	20 ± 0.3	4.6 ± 0.1
CP402533 ¹	25 ± 0.3	25 ± 0.3	3.3 ± 0.1
CP40301547	30 ± 0.3	15 ± 0.3	4.6 ± 0.1
CP40347 ¹	30 ± 0.3	30 ± 0.3	4.6 ± 0.1
CP40439 ¹	40 ± 0.3	40 ± 0.3	3.9 ± 0.1
CP404046	40 ± 0.3	40 ± 0.3	4.6 ± 0.1
CP40447 ¹	40 ± 0.3	40 ± 0.3	4.6 ± 0.1
CP4055485 ¹	55 ± 0.3	55 ± 0.3	4.85 ± 0.1

Notes: 1. Wire lead strip length on models CP40347, CP40447, CP40439, CP402533, & CP4055485 is 10 ± 3.0 mm.

CP40136 PERFORMANCE (Th=27°C)

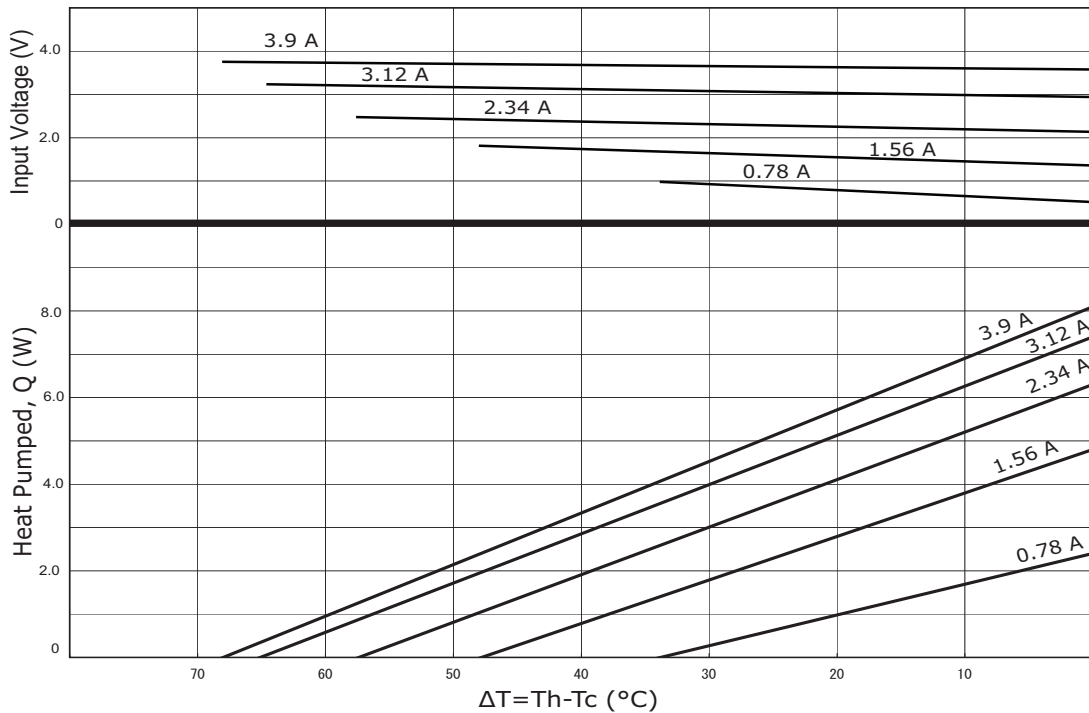

CP40136 PERFORMANCE (Th=50°C)

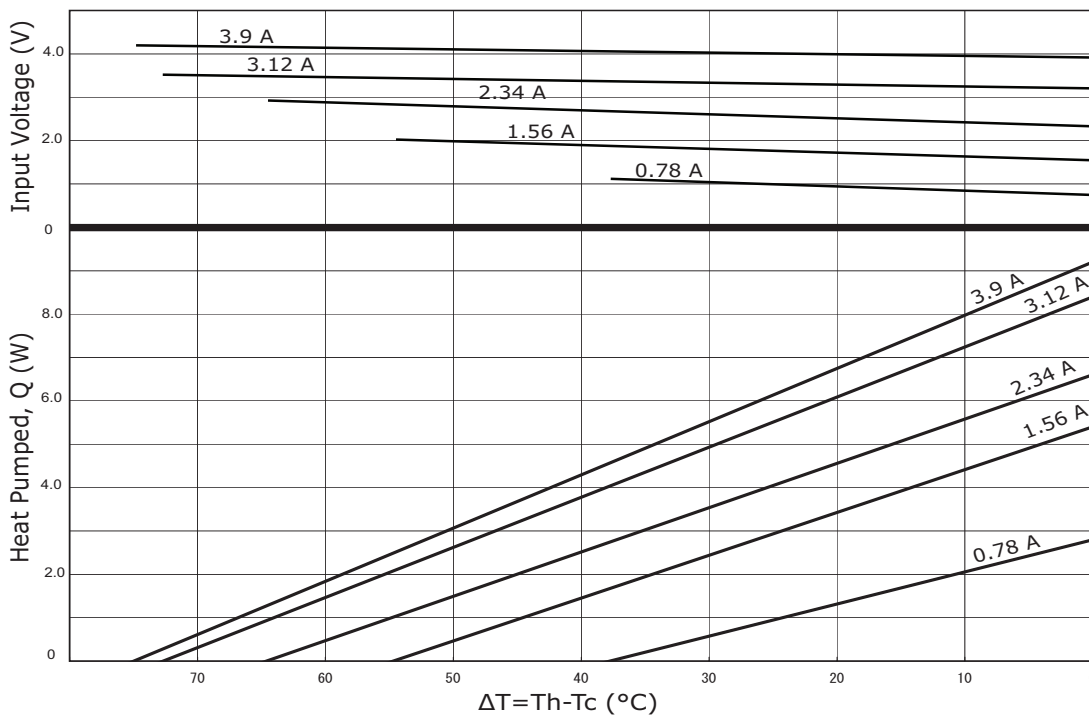

CP40236 PERFORMANCE (Th=27°C)

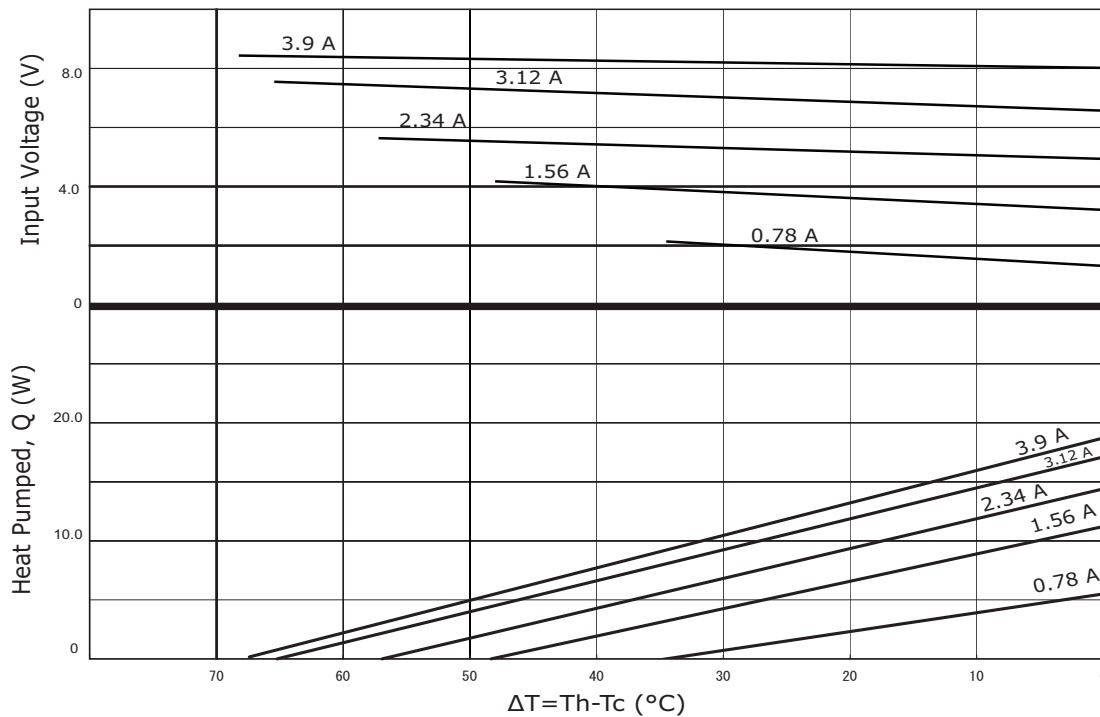

CP40236 PERFORMANCE (Th=50°C)

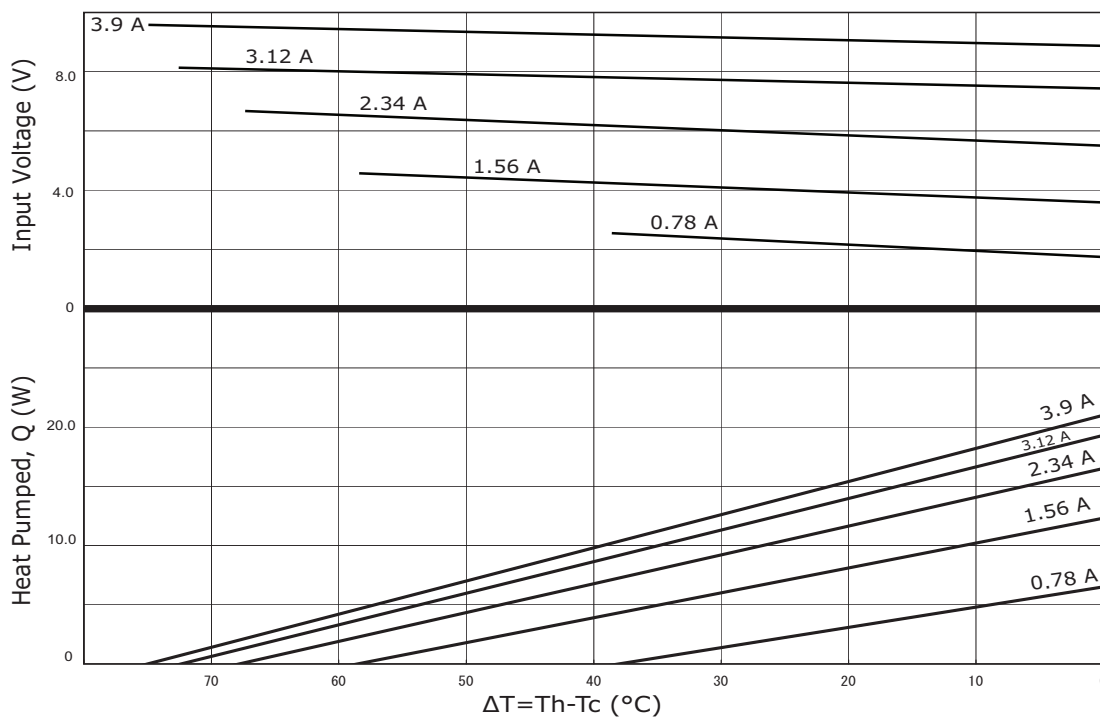

CP40336 PERFORMANCE (Th=27°C)

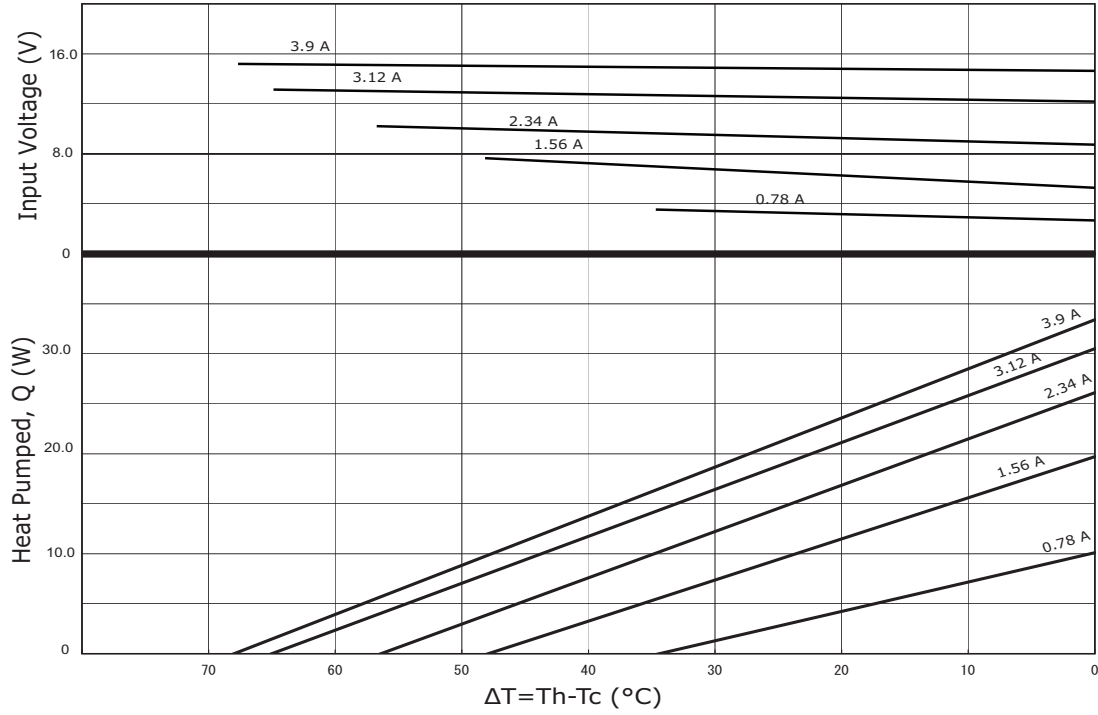

CP40336 PERFORMANCE (Th=50°C)

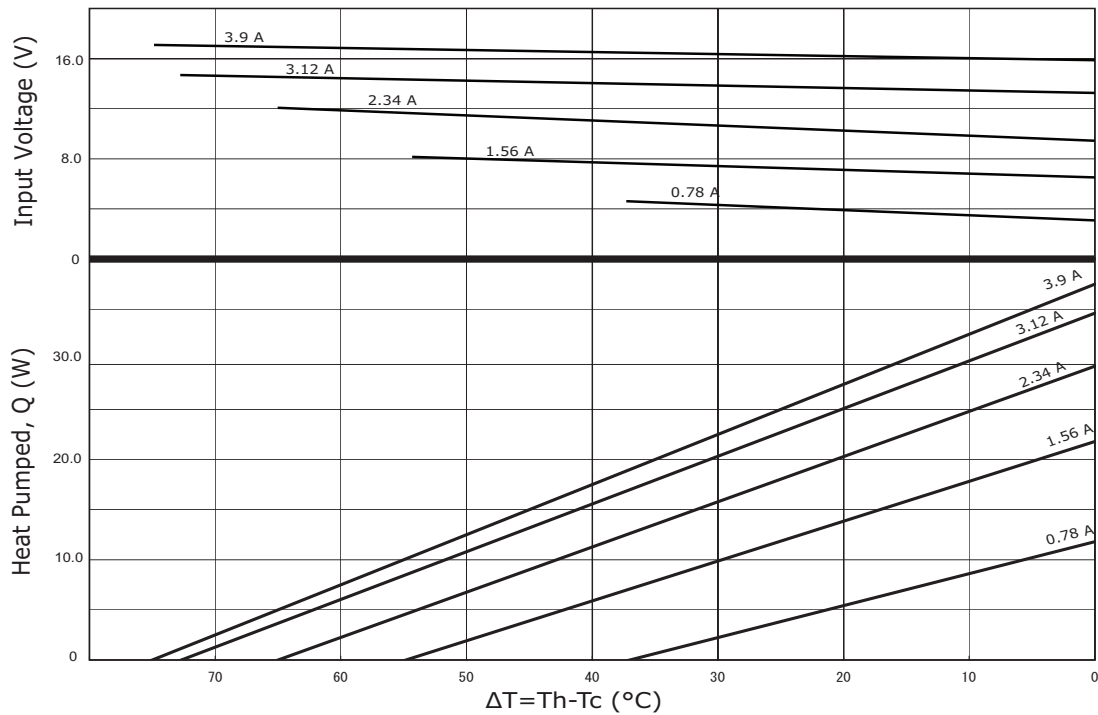

CP40147 PERFORMANCE (Th=27°C)

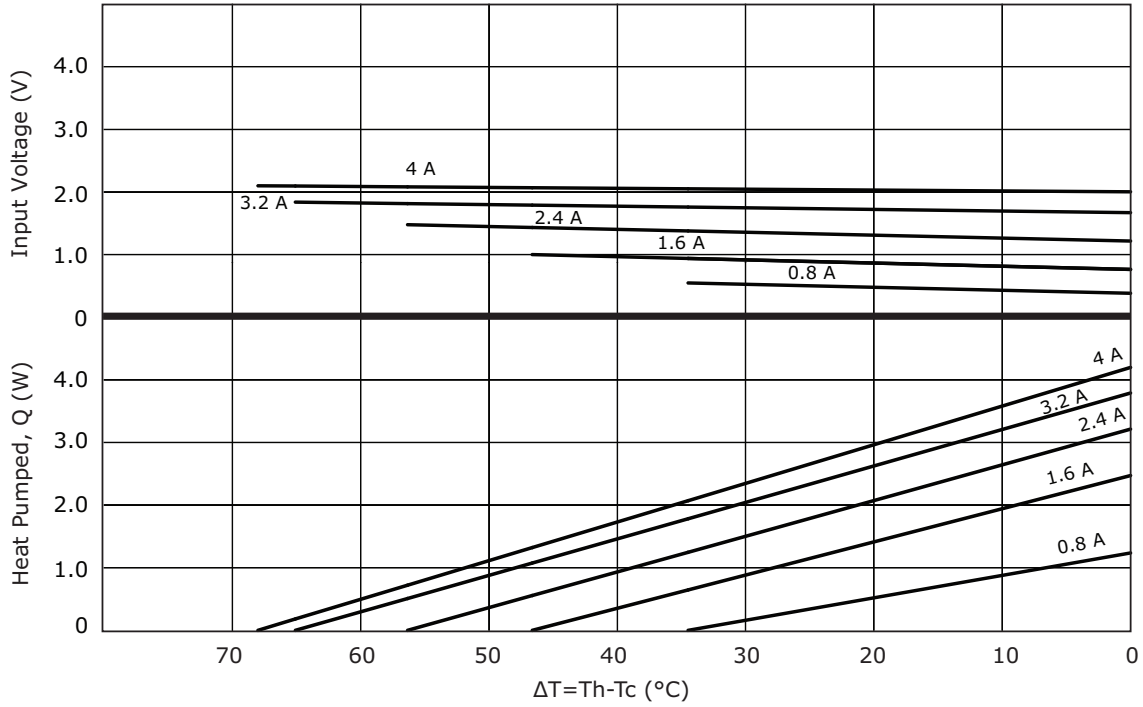

CP40147 PERFORMANCE (Th=50°C)

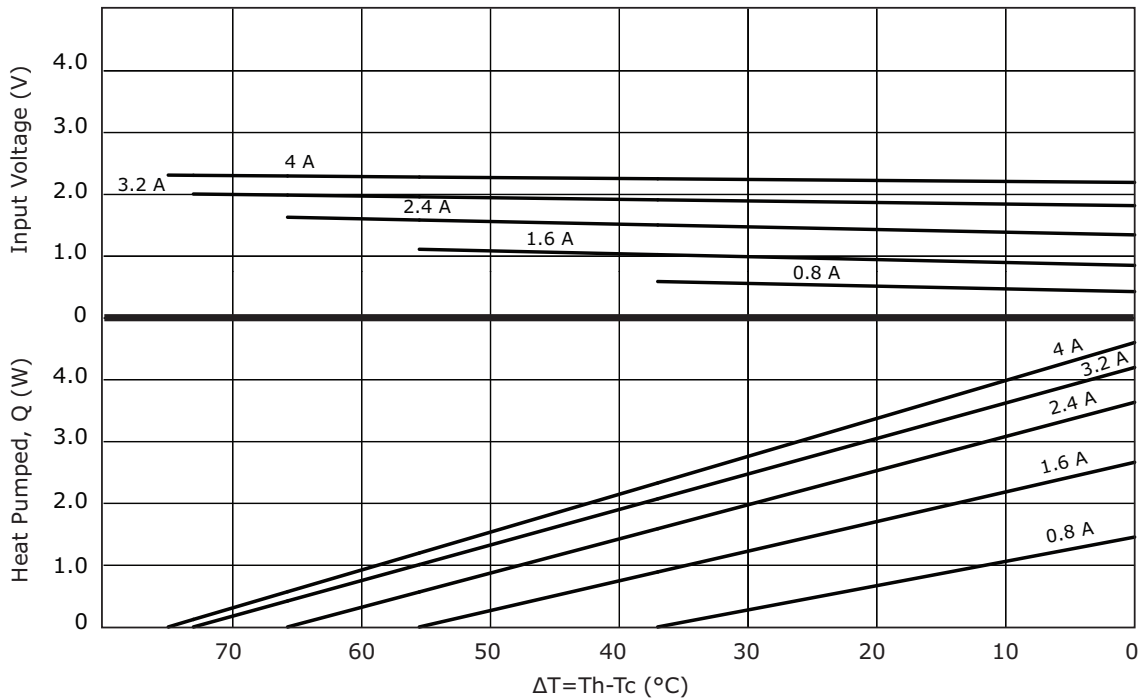

CP40247 PERFORMANCE (Th=27°C)

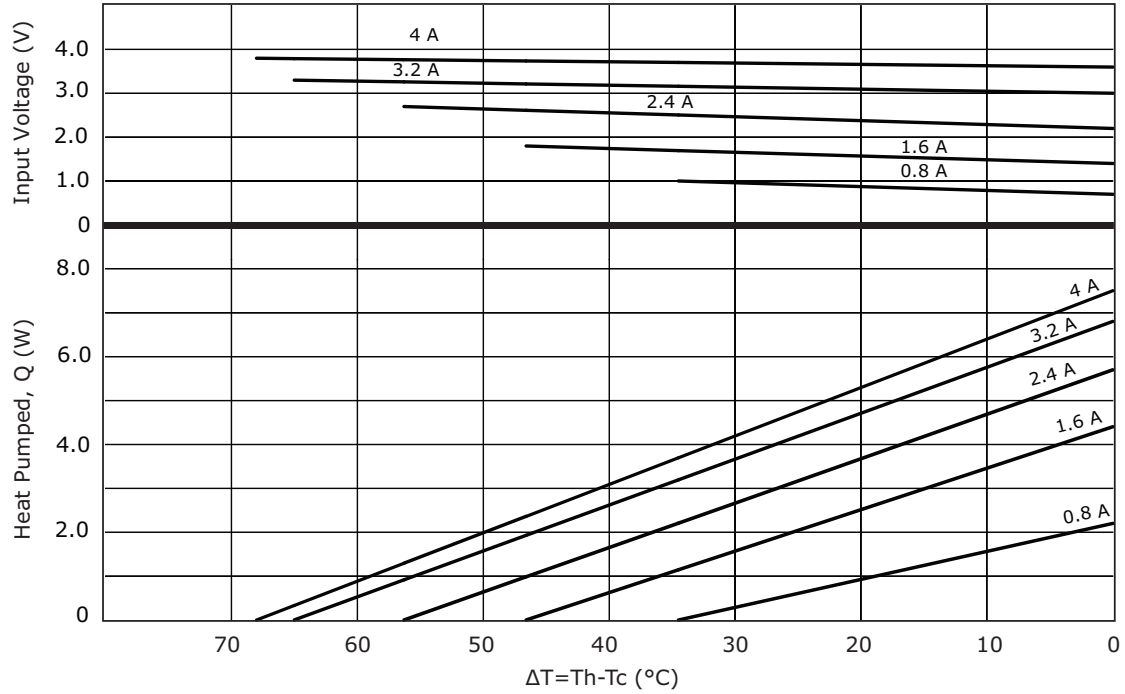

CP40247 PERFORMANCE (Th=50°C)

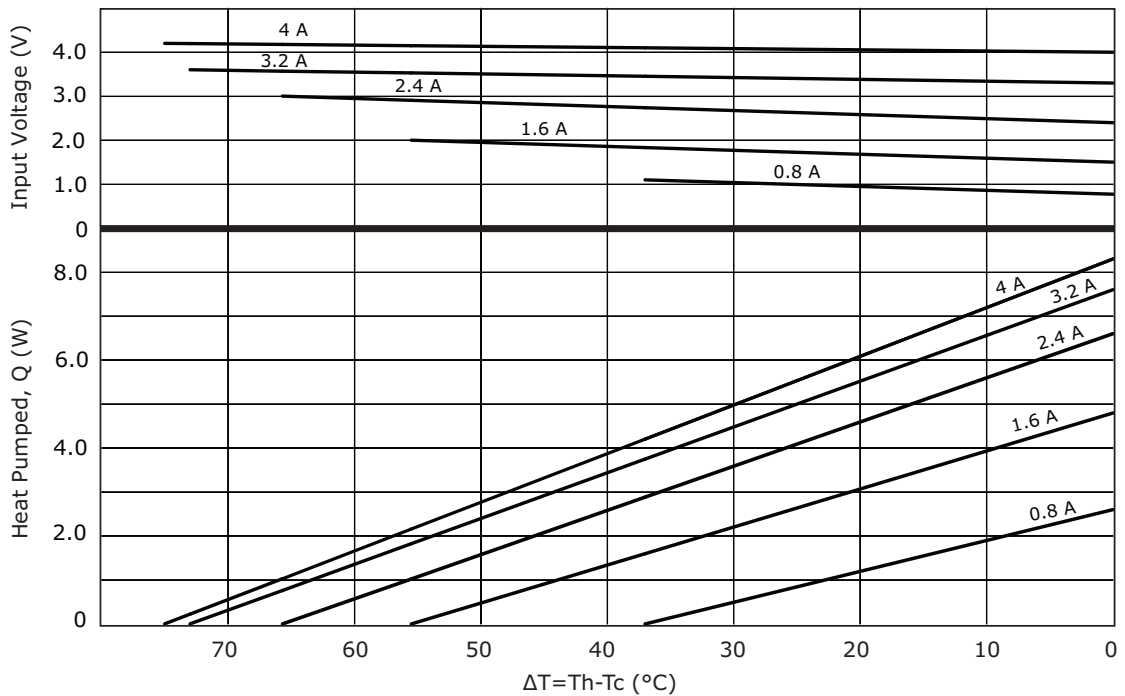

CP402533 PERFORMANCE (Th=27°C)

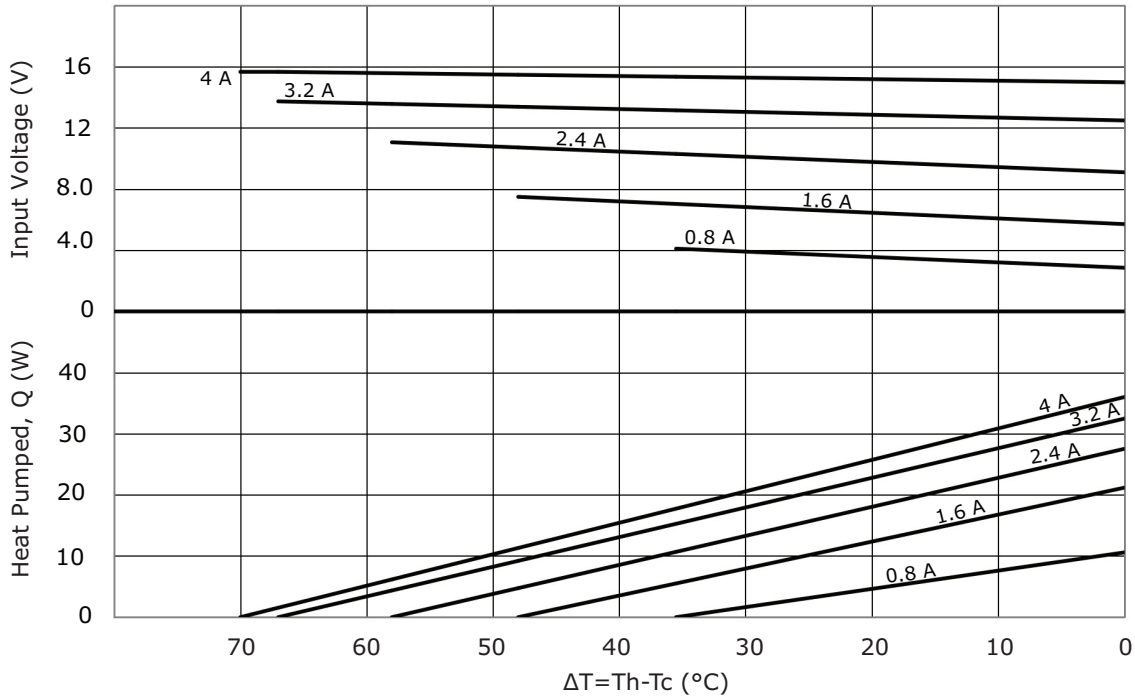

CP402533 PERFORMANCE (Th=50°C)

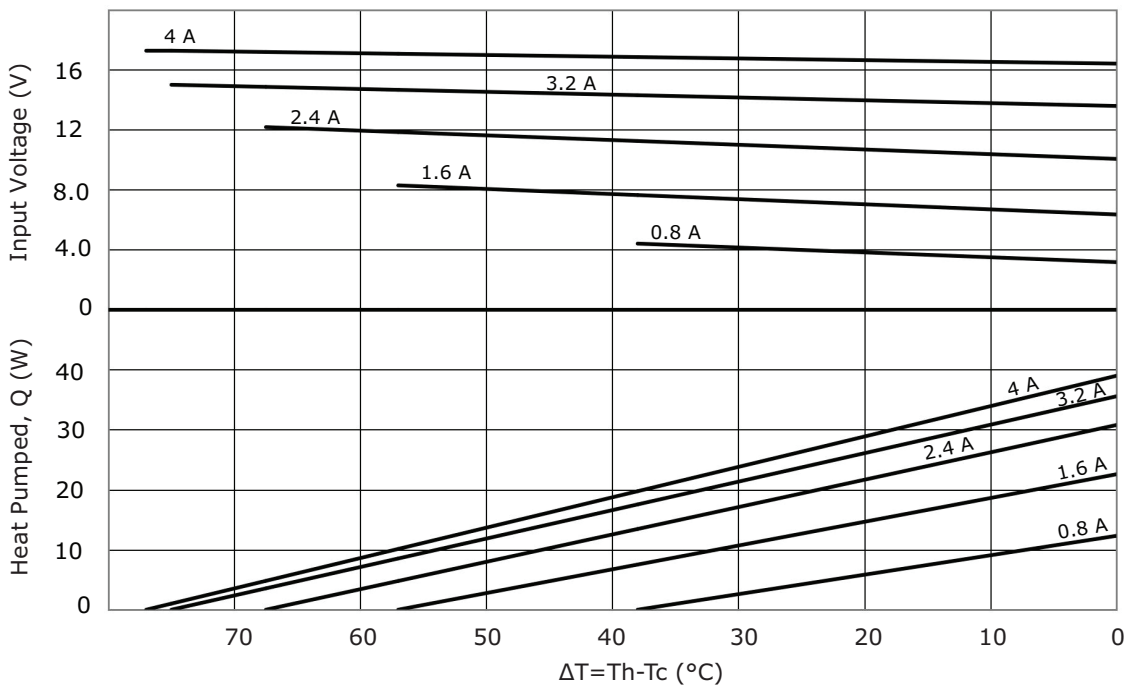

CP40301547 PERFORMANCE (Th=27°C)

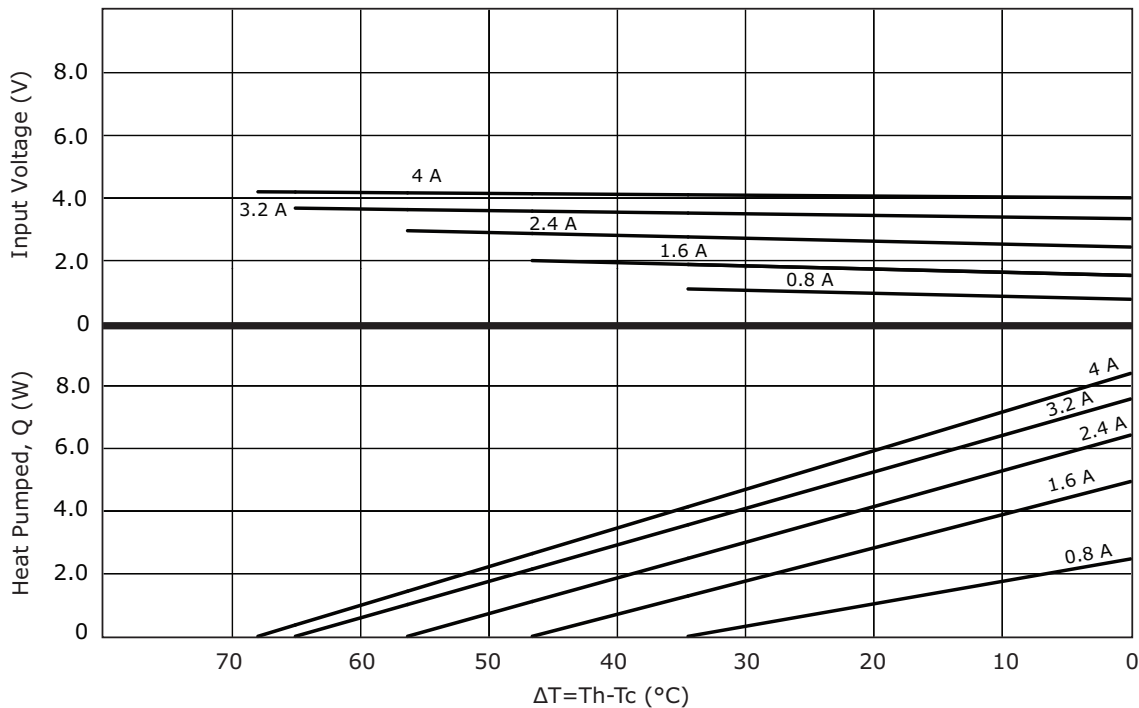

CP40301547 PERFORMANCE (Th=50°C)

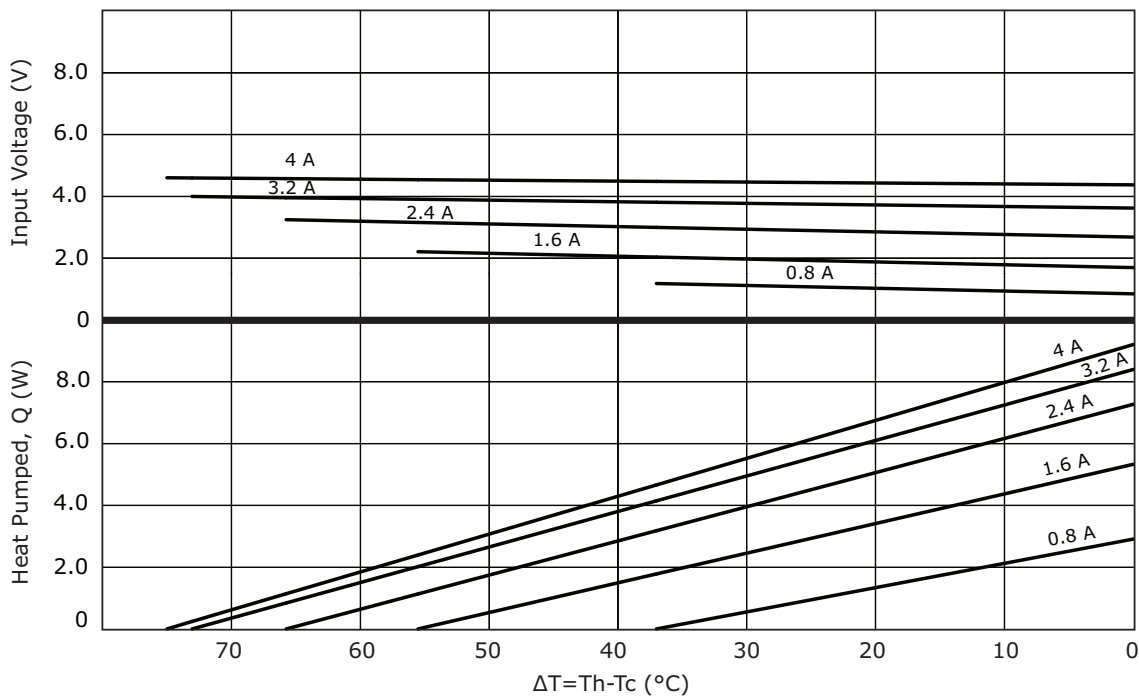

CP40347 PERFORMANCE (Th=27°C)

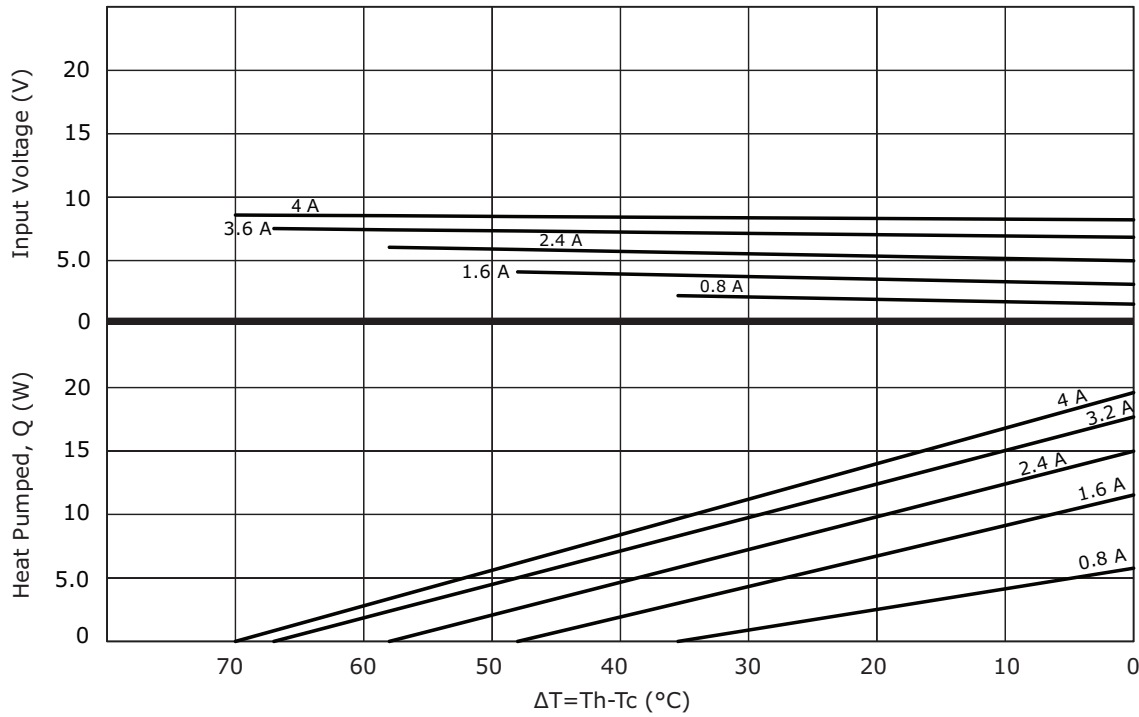

CP40347 PERFORMANCE (Th=50°C)

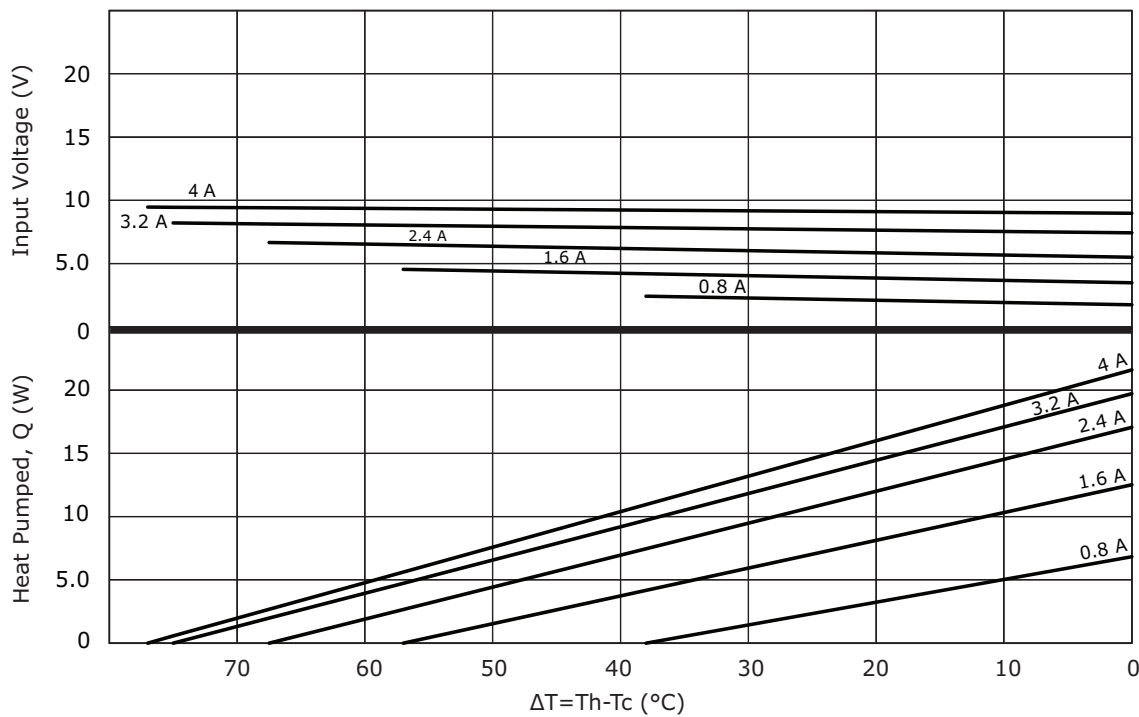

CP40439 PERFORMANCE (Th=27°C)

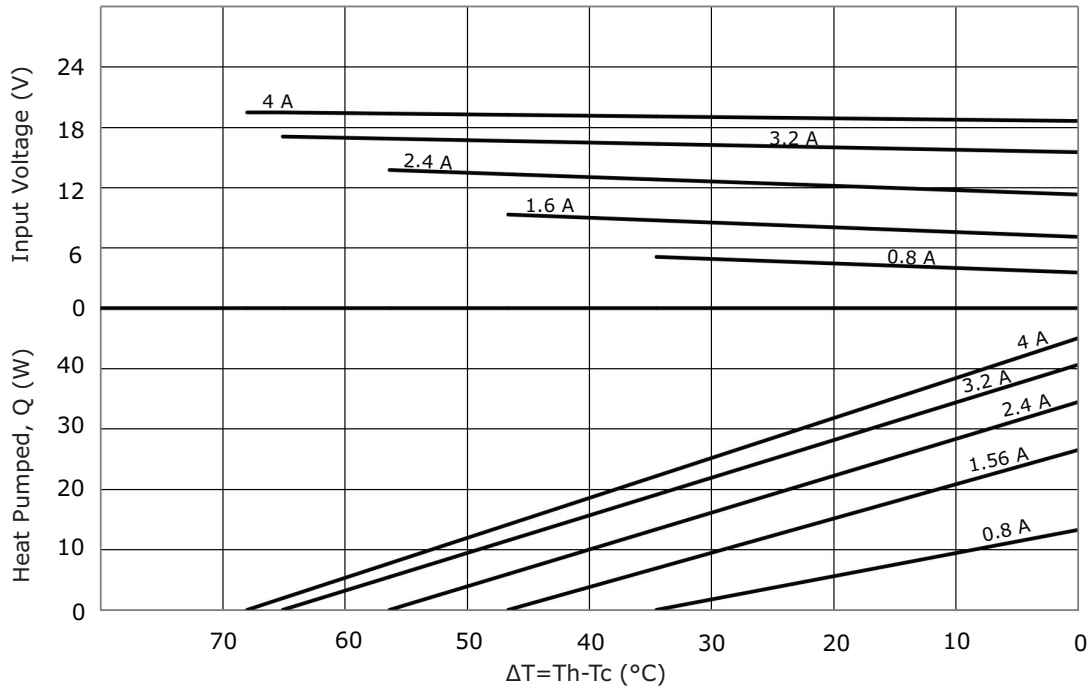

CP40439 PERFORMANCE (Th=50°C)

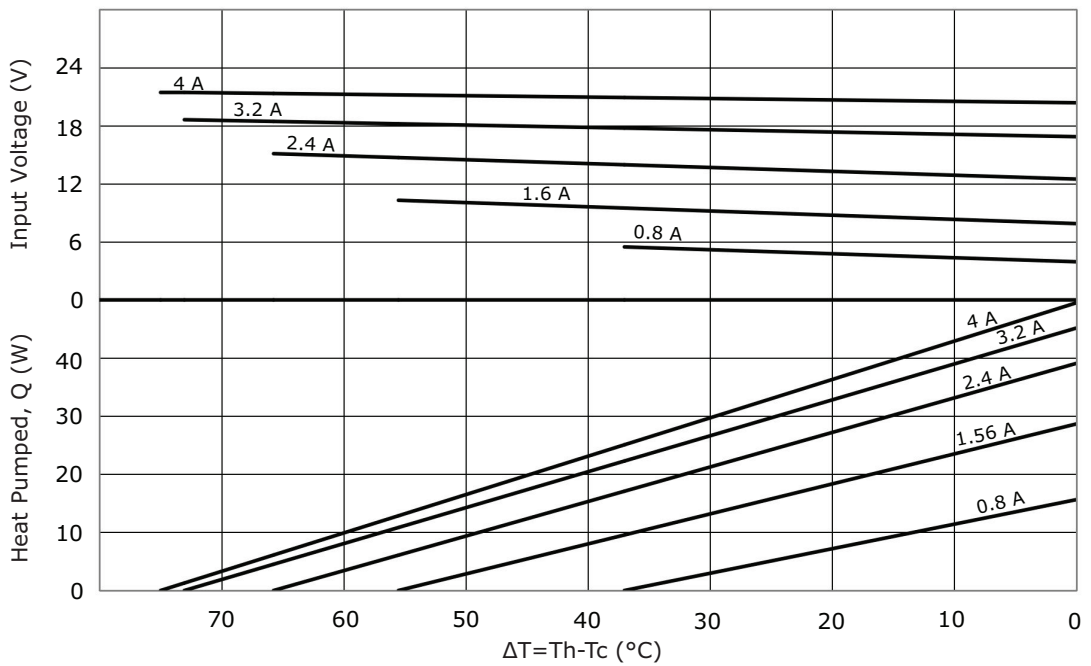

CP404046 PERFORMANCE (Th=27°C)

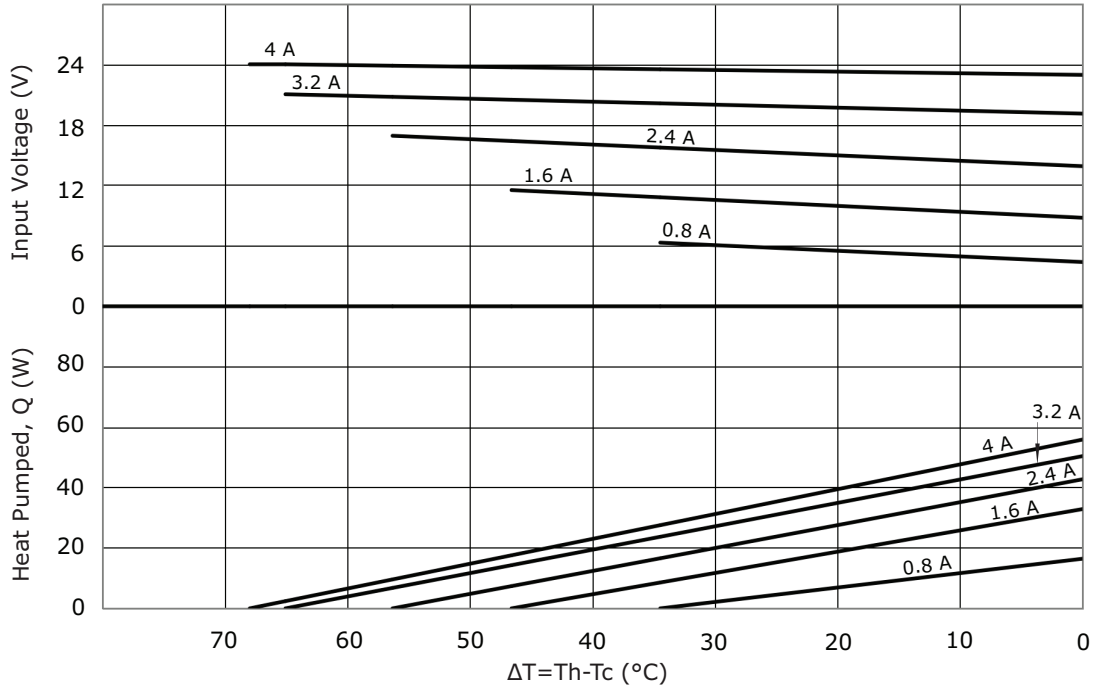

CP404046 PERFORMANCE (Th=50°C)

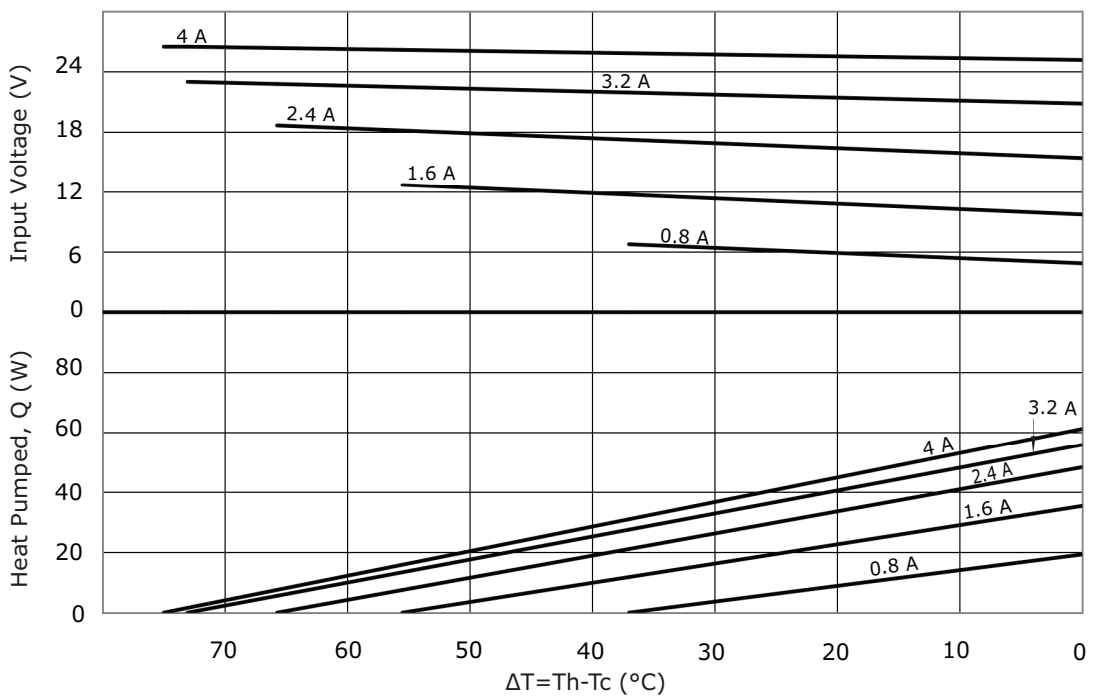

CP40447 PERFORMANCE (Th=27°C)

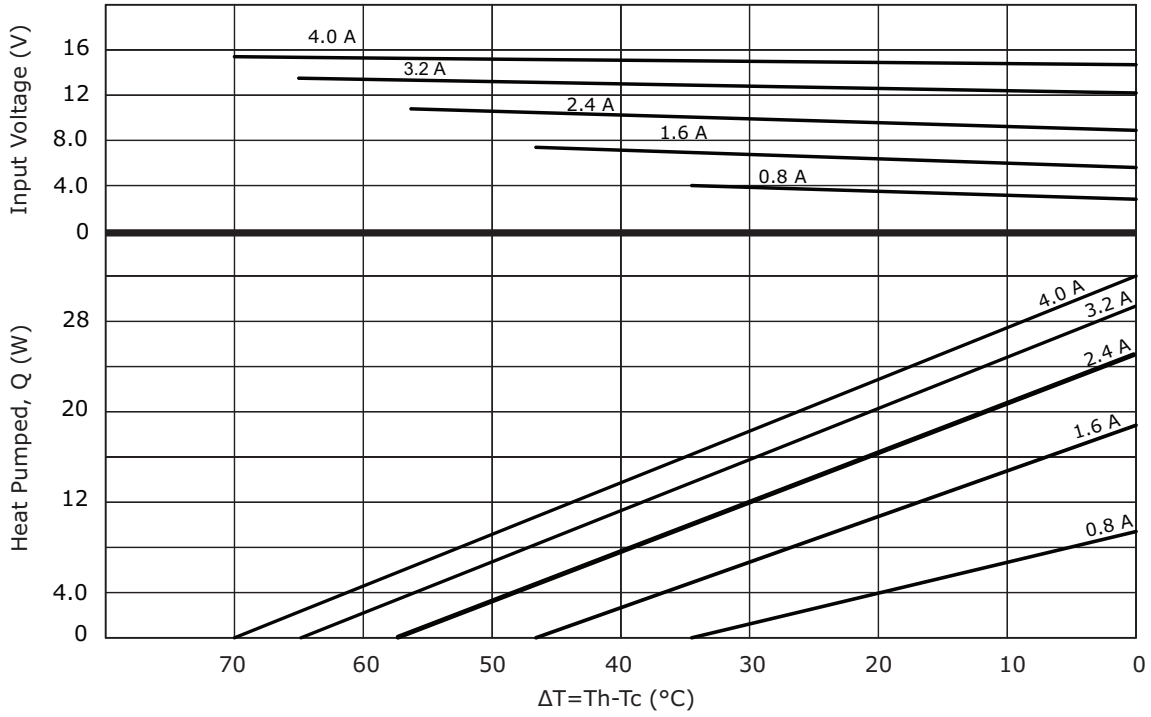

CP40447 PERFORMANCE (Th=50°C)

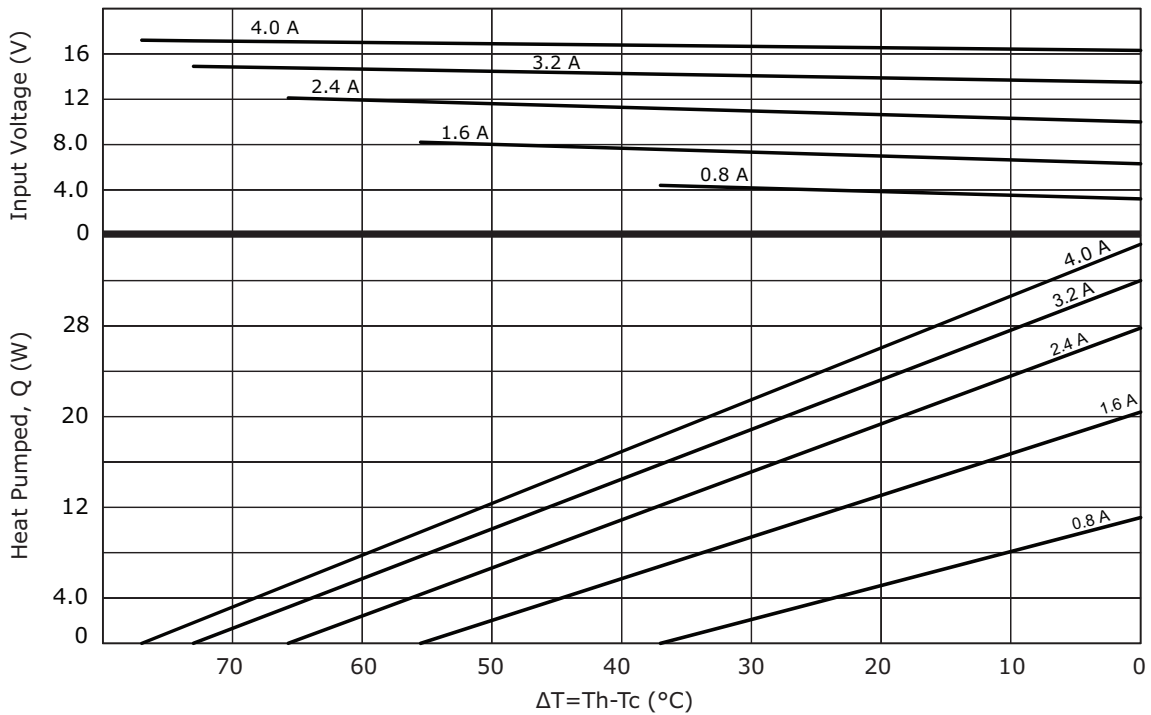

CP4055485 PERFORMANCE (Th=27°C)

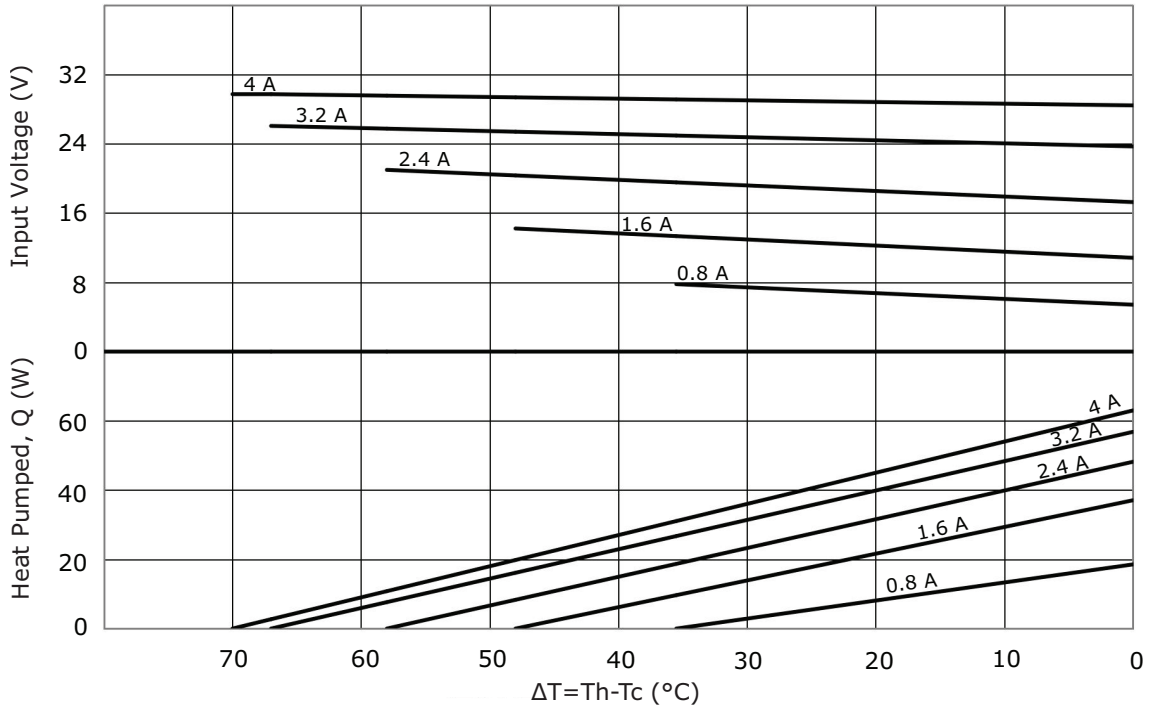

CP4055485 PERFORMANCE (Th=50°C)

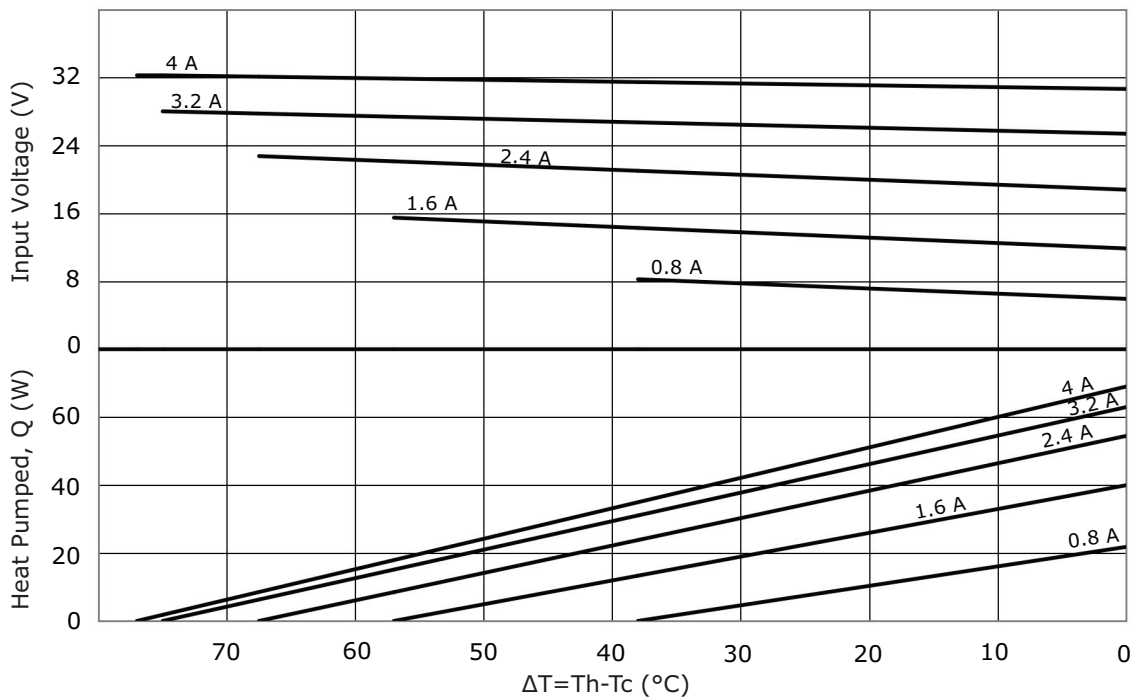

REVISION HISTORY

rev.	description	date
1.0	initial release	09/03/2009
1.01	applied new template	05/08/2012
1.02	added new models	09/08/2016
1.03	changed models CP40347 & CP40447 to arcTEC™ structure	12/01/2017
1.04	changed thickness of CP40147, CP40247, CP40301547 models	09/19/2018
1.05	added models CP40439, CP404046, CP4055485, brand update	10/18/2019
1.06	added model CP402533	11/17/2020

The revision history provided is for informational purposes only and is believed to be accurate.

CUI DEVICES

CUI Devices offers a one (1) year limited warranty. Complete warranty information is listed on our website.

CUI Devices reserves the right to make changes to the product at any time without notice. Information provided by CUI Devices is believed to be accurate and reliable. However, no responsibility is assumed by CUI Devices for its use, nor for any infringements of patents or other rights of third parties which may result from its use.

CUI Devices products are not authorized or warranted for use as critical components in equipment that requires an extremely high level of reliability. A critical component is any component of a life support device or system whose failure to perform can be reasonably expected to cause the failure of the life support device or system, or to affect its safety or effectiveness.