



GRL18S-P2338

GR18

CYLINDRICAL PHOTOELECTRIC SENSORS

SICK
Sensor Intelligence.



Ordering information

Type	Part no.
GRL18S-P2338	1058212

Other models and accessories → www.sick.com/GR18

Illustration may differ



Detailed technical data

Features

Functional principle	Photoelectric retro-reflective sensor
Functional principle detail	Dual lens
Dimensions (W x H x D)	18 mm x 18 mm x 38.1 mm
Housing design (light emission)	Cylindrical
Thread diameter (housing)	M18 x 1
Optical axis	Radial
Sensing range max.	0.03 m ... 7.2 m ¹⁾
Sensing range	0.06 m ... 6 m ¹⁾
Type of light	Visible red light
Light source	PinPoint LED ²⁾
Light spot size (distance)	Ø 175 mm (7 m)
Wave length	650 nm
Adjustment	None
Indication	
	LED green Operating indicator Static on: power on
	LED yellow Status of received light beam Static on: object not present Static off: object present

¹⁾ Reflector PL80A.

²⁾ Average service life: 100,000 h at T_U = +25 °C.

Mechanics/electronics

Supply voltage	10 V DC ... 30 V DC ¹⁾
Ripple	< 5 V _{pp} ²⁾
Current consumption	30 mA
Switching output	PNP
Switching mode	Light switching
Signal voltage PNP HIGH/LOW	V _S - (≤ 3 V) / approx. 0 V
Output current I_{max.}	≤ 100 mA ³⁾
Response time	< 500 μs ⁴⁾
Switching frequency	1,000 Hz ⁵⁾
Connection type	Connector M12, 3-pin
Circuit protection	A ⁶⁾ B ⁷⁾ D ⁸⁾
Protection class	III
Polarisation filter	✓
Housing material	Plastic, ABS
Optics material	Plastic, PMMA
Enclosure rating	IP67
Items supplied	Fastening nuts (2 x)
Electromagnetic compatibility (EMC)	EN 60947-5-2
Ambient operating temperature	-25 °C ... +55 °C ⁹⁾
Ambient temperature, storage	-40 °C ... +70 °C
UL File No.	NRKH.E348498 & NRKH7.E348498

¹⁾ Limit values. Operated in short-circuit protected network: max. 8 A.

²⁾ May not exceed or fall below U_v tolerances.

³⁾ At U_v > 24 V or ambient temperature > 49 °C, I_A max. = 50 mA.

⁴⁾ Signal transit time with resistive load.

⁵⁾ With light/dark ratio 1:1.

⁶⁾ A = V_S connections reverse-polarity protected.

⁷⁾ B = inputs and output reverse-polarity protected.

⁸⁾ D = outputs overcurrent and short-circuit protected.

⁹⁾ At U_v <= 24V and I_A < 50mA.

Classifications

eCl@ss 5.0	27270902
eCl@ss 5.1.4	27270902
eCl@ss 6.0	27270902
eCl@ss 6.2	27270902
eCl@ss 7.0	27270902
eCl@ss 8.0	27270902
eCl@ss 8.1	27270902
eCl@ss 9.0	27270902
eCl@ss 10.0	27270902

eCl@ss 11.0	27270902
eCl@ss 12.0	27270902
ETIM 5.0	EC002717
ETIM 6.0	EC002717
ETIM 7.0	EC002717
ETIM 8.0	EC002717
UNSPSC 16.0901	39121528

Connection type

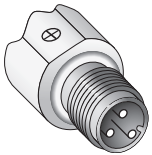

Connection diagram

Cd-045

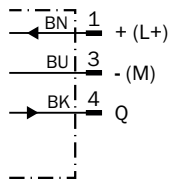

Characteristic curve

GRL18S

Operating reserve

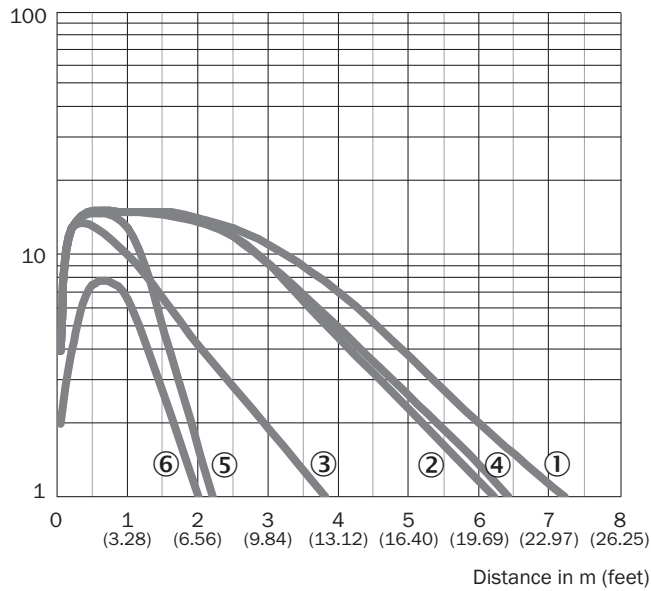

- ① Reflector PL80A
- ② Reflector PL40A
- ③ Reflector PL20A
- ④ Reflector P250
- ⑤ Reflector PL22
- ⑥ Reflective tape REF-Plus 3436

Light spot size

GRL18S

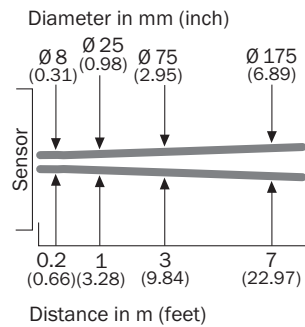

Sensing range diagram

GRL18S

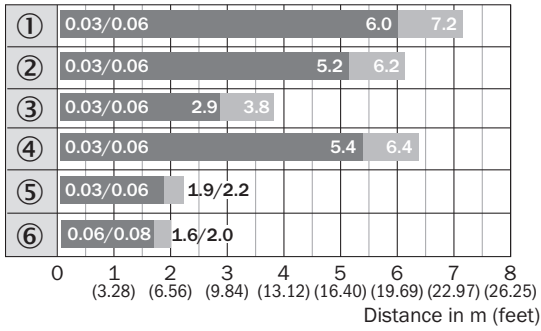

■ Sensing range ■ Sensing range max.

- ① Reflector PL80A
- ② Reflector PL40A
- ③ Reflector PL20A
- ④ Reflector P250
- ⑤ Reflector PL22
- ⑥ Reflective tape REF-Plus 3436

Response range

GRL18S

Parallel operating range y in mm (inch)

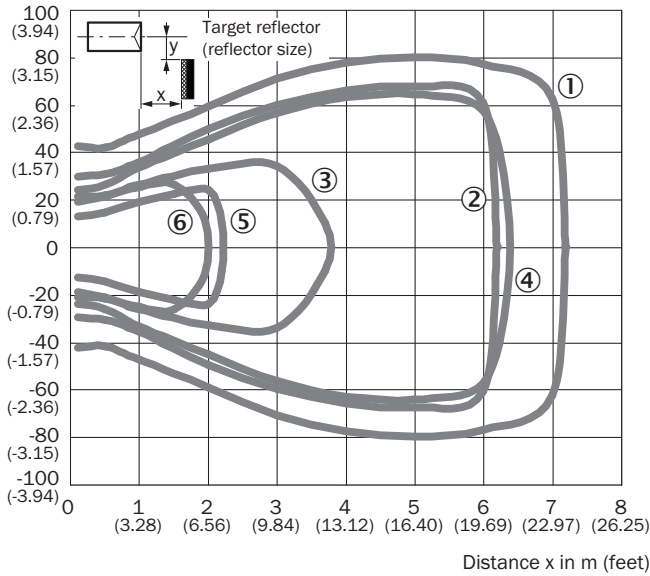

- ① Reflector PL80A
- ② Reflector PL40A
- ③ Reflector PL20A
- ④ Reflector P250
- ⑤ Reflector PL22
- ⑥ Reflective tape REF-Plus 3436

Dimensional drawing (Dimensions in mm (inch))

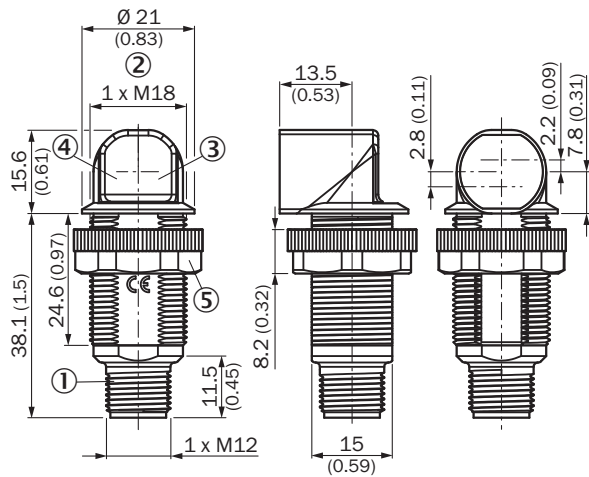

GR18S, plastic, connector, angled



- ① Connector M12, 3-pin
- ② Threaded mounting hole M18 x 1
- ③ LED indicator yellow
- ④ LED indicator green
- ⑤ Fastening nut; 22 mm hex, plastic

Recommended accessories

Other models and accessories → www.sick.com/GR18

	Brief description	Type	Part no.
Mounting brackets and plates			
	Mounting bracket for M18 sensors, steel, zinc coated, without mounting hardware	BEF-WN-M18	5308446
	Universal mounting bracket for reflectors, steel, zinc coated	BEF-WN-REFX	2064574
Reflectors			
	Rectangular, screw connection, 51 mm x 61 mm, PMMA/ABS, Screw-on, 2 hole mounting	P250	5304812

SICK AT A GLANCE

SICK is one of the leading manufacturers of intelligent sensors and sensor solutions for industrial applications. A unique range of products and services creates the perfect basis for controlling processes securely and efficiently, protecting individuals from accidents and preventing damage to the environment.

We have extensive experience in a wide range of industries and understand their processes and requirements. With intelligent sensors, we can deliver exactly what our customers need. In application centers in Europe, Asia and North America, system solutions are tested and optimized in accordance with customer specifications. All this makes us a reliable supplier and development partner.

Comprehensive services complete our offering: SICK LifeTime Services provide support throughout the machine life cycle and ensure safety and productivity.

For us, that is “Sensor Intelligence.”

WORLDWIDE PRESENCE:

Contacts and other locations –www.sick.com