

ASP1400

Bidirectional Differential Pressure Meter

SENSIRION
THE SENSOR COMPANY

- Ultra low differential pressure from 100 Pa down to 0.002 Pa
- Zero drift & offset free
- Outstanding accuracy and resolution
- Ultra fast response time
- Fully calibrated & temperature compensated
- Digital output signal



Datasheet – April 2008 v2

ASP1400 Product Summary

The ASP1400 differential pressure sensor is especially suited for measurements of ultra low pressure differences of gases and true mass flow measurements in bypass solutions.

The micro-machined silicon sensor element of the ASP1400 enables extremely long term stable and offset free measurements. Its leading performance is based on SENSIRION's unsurpassed CMOSens[®] technology. With CMOSens[®], the on-chip sensor element forms an integrated whole with the amplification and A/D converter circuit. This results in superior resolution, fast response time and large dynamic range at lowest power consumption.

All measurement data is fully calibrated and temperature compensated by means of an internal micro controller.

Mounted in rugged, chemically inert PBT housing the ASP1400 is suitable for a wide range of applications. Such include for example monitoring of clean room conditions, intrusion detection and almost unlimited bypass solutions in process control, building control as well as medical applications.

Bypass solutions allow a true mass flow measurement. The sensor housing provides two inlets for measuring the differential pressure and withstands overpressures of 1 bar (15 psi).

The ASP1400 requires a supply voltage of 7...18Vdc and provides an RS-232 electrical interface.

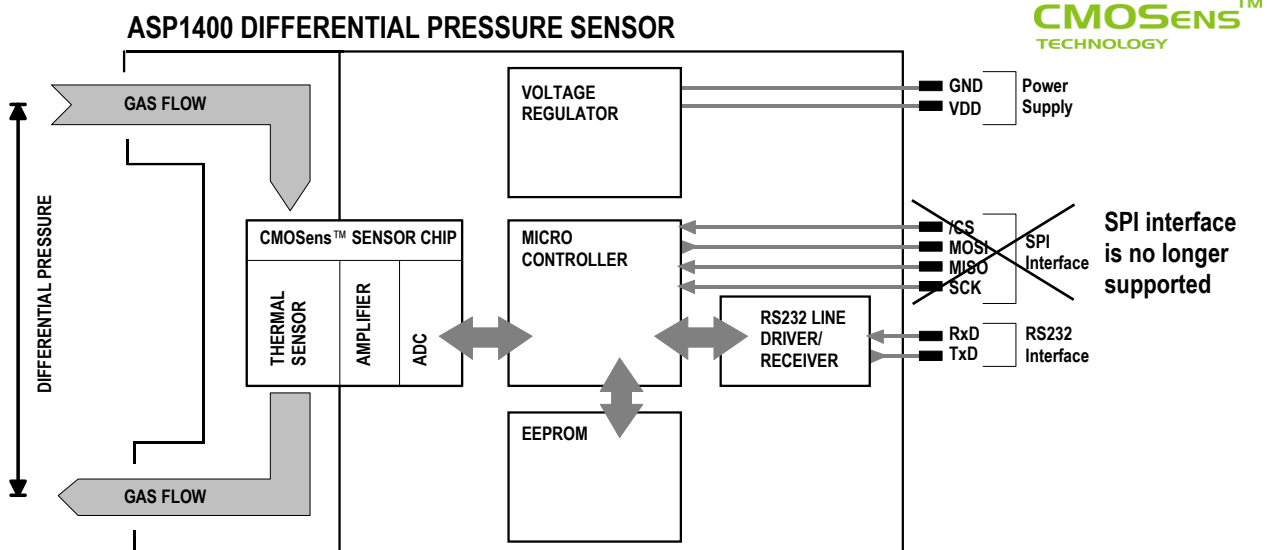

Figure 1: Block Diagram ASP1400 Differential Pressure Sensor with CMOSens[®] technology

Introductory Description

Combining solid state sensor technology and commercial IC fabrication, the ASP1400 dynamic differential pressure sensor produced by SENSIRION provides unbeatable performance at very low cost. The lowest detectable differential pressure is 0.002 Pa, which corresponds to a force of only 0.00002g per cm² or a geographic height difference of only 0.16 mm. Covering at the same time a differential pressure range of more than 4 orders of magnitude, the ASP1400 sets a new standard wherever dynamic differential pressure has to be measured or controlled. The ASP1400 device measures the differential pressure with a dynamic principle⁽¹⁾. The differential pressure induces a small gas flow through a tube of 1mm diameter. SENSIRION's unique CMOSens[®] technology provides an extremely precise measurement of this gas flow even for very small differential pressures. In addition, the sensor signal is almost offset free and highly long term stable. You simply connect the gas differential pressure to be measured to the ASP1400 device to get an instantaneous differential pressure at a sampling rate of up to 7Hz (please contact us for sampling rates of up to 200Hz). The ASP1400 withstands overpressures up to 1 bar without any loss in precision.

Please note that absolute pressure (see section 1.4) and gas composition have to be well-known to achieve measurements of highest accuracy.

The ASP1400 differential pressure sensor allows an easy realization of high precision bypass solutions for true mass flow measurements. It has to be pointed out that the ASP1400 is based on the successful ASF1400 mass flow sensor. It measures differential pressure indirectly with the mass flow, which is generated through the applied differential pressure. Unlike with static differential pressure sensors, you therefore profit in bypass solutions directly from a true mass flow measurement.

In addition to differential pressure, the ASP1400 device also provides information about the temperature on the CMOSens[®] sensor chip. Both

differential pressure and temperature data are accessed through an RS-232 interface. The RS-232 interface allows you to connect the ASP1400 device directly to a PC or PDA using standard terminal software.

In general, differential pressures of all gas types can be measured using the ASP1400 product. Calibration is done for dry air. Please contact SENSIRION, if you would like to use the sensor for applications with other gases.

⁽¹⁾ Please note that a small gas flow through the sensor is inherent in the dynamic measurement principle. Thus, the ASP1400 is not suitable for applications where no gas flow is allowed.

CMOSens[®] sensor technology

CMOSens[®] is the base technology for all Sensirion multi sensor modules and sensor systems. The unification of semiconductor chip and sensor technology serves as a platform for highly integrated system solutions with excellent sensor precision and reliability. With CMOSens[®], the on-chip sensor element forms an integrated whole with the high-end amplification and A/D converter circuit. Due to the compact single-chip design, CMOSens[®] based sensors are very resistant to electromagnetic disturbances (EMC), another important technical advantage of this state of the art sensor technology. As a result, CMOSens[®] based multi sensor modules offer an excellent sensor precision, a fast response time and a very large dynamic measurement range. In addition, the digital intelligence of the CMOSens[®] sensor technology enables digital interfaces that permit an easy link with the system of the customer, a real advantage and benefit that results in ready-to-use problem solutions ("Mount&Sense").

1 Dynamic Differential Pressure Sensor Performance

Table 1: Overview ASP1400 Gas Sensor Performance

Parameter	Condition	Minimum	Typical	Maximum	Units
Differential Pressure					
Principle of measurement	Dynamic mass flow generated by differential pressure				
Dynamic Range	direct measurement	-100		100	Pa
	customer specific solutions	< 3500			Pa
Lowest Detectable Pressure	< 1 Pa		0.002		Pa
Medium	no liquids		Gas		
Calibration gas			Dry air ⁽¹⁾		
Resolution	$\Delta p \approx 100$ Pa, $p_{abs}=1.013$ bar		0.04		Pa
	$\Delta p < 1$ Pa, $p_{abs}=1.013$ bar		0.001		Pa
Overpressure Resistance			1	1.5	bar
Gas Flow ⁽²⁾	air, 100 Pa diff. pressure		0.4		ln/min ⁽³⁾
Repeatability	Range 0.5 Pa to 100 Pa		0.002% FS ⁽⁴⁾ 0.08 % m.V.		
Accuracy	dry air / 20 °C / 966 mbar		0.05 % FS ⁽⁵⁾ 1.5 % m.V.		
Offset	20 °C		0.004	0.02	% FS
Response Time	depends on resolution setting (see Section 3, Table 2)	142		1280	ms
Operating Temperature		0 [32]		70 [158]	°C [°F]
Ambient Temperature Coefficient	Zero		< 0.002		% FS / °C
	Span		< 0.09		% m.V. / °C
Position sensitivity (inclination)	$p_{abs}=1$ bar, small air flow		± 0.004		% FS
Temperature Sensor Measures temperature inside the sensor, but not of the surrounding air ⁽⁶⁾					
Dynamic Range		0		70	°C
Resolution			0.1		°C
Accuracy		3	2		°C

Note: All data for dry air at 20 °C and 966 mbar unless otherwise noted.

⁽¹⁾ Contact us for other gases

⁽²⁾ Due to dynamic measurement principle (see Figure 4)

⁽³⁾ 1 ln/min = 1 norm liter per minute = 1 liter/min at 0 °C and $p = 1013.25$ mbar

⁽⁴⁾ Error = % of full scale (FS) or % of measured value, whichever is bigger.

⁽⁵⁾ Accuracy:

0.05 % of full scale (FS) for measured values between 0-3.3% of full scale (i.e. 0-3.3 Pa) and

1.5 % of measured value (m.V.) for measured values between 3.3-100% of full scale (i.e. 3.3-100 Pa)

⁽⁶⁾ The sensors warms up by about 7 °C (depending on supply voltage and ventilation).

1.1 Differential Pressure Characteristics

Figure 2 shows the differential pressure vs. the digital output of the ASP1400.

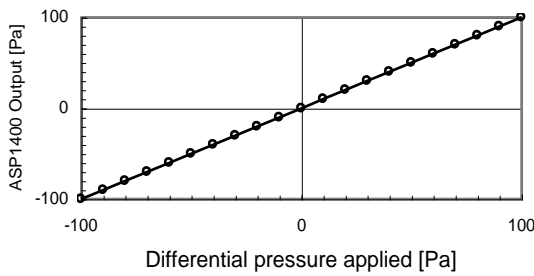

Figure 2: ASP1400 transfer characteristics.

1.2 Sensor Principle and Gas Types

The ASP1400 device measures differential pressure indirectly. The sensor effectively uses a calorimetric method, where fluid motion is converted into thermal information. A heating resistor on a thermally insulated membrane is kept above ambient temperature. In the presence of gas flow, the temperature distribution up- and downstream is disturbed. This asymmetry is then measured. Due to the minimal thermal mass of the membrane, symmetrical arrangement, and accurate temperature measurement, the revolutionary specifications of the ASP1400 devices are achieved.

The above mentioned thermal principle requires information about the gas type to be measured. The standard ASP1400 is calibrated for differential pressure measurements of dry air. Please contact SENSIRION, if you would like to use the sensor for applications with other gases.

In Figure 3 the repeatability of the ASP1400 devices is compared with the repeatability of a typical differential pressure sensor. It emphasizes the superior performance of the ASP1400 device.

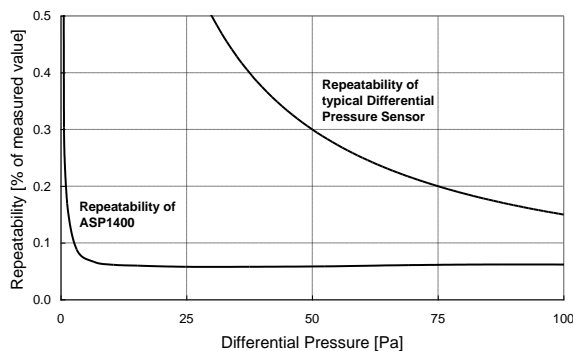

Figure 3: Comparison of the repeatability of the ASP1400 CMOSens® sensor with a typical differential pressure sensor.

1.3 Gas Flow and Pressure Difference

The ASP1400 is calibrated for differential pressure measurements. However, there is a well defined relation between pressure drop and mass flow. This relationship is shown in Figure 4. On request the ASP1400 can also be calibrated to measure mass flow instead of differential pressure (for more details refer to the documentation of the SENSIRION Mass Flow Meter ASF1430).

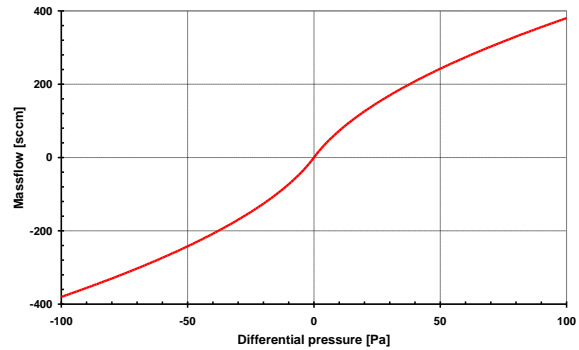

Figure 4: Differential Pressure vs. Mass Flow of ASP1400 device.

1.4 High Precision Differential Pressure Measurement in Bypass solutions

The ASP1400 differential pressure sensor is exceptionally well suited in conjunction with customer specific bypass configurations (see Figure 5). SENSIRION's expertise in packaging and flow measurement combined with the accurate low differential pressure measurement ability of the ASP1400, enables the design of novel bypass solutions over a wide dynamic range.

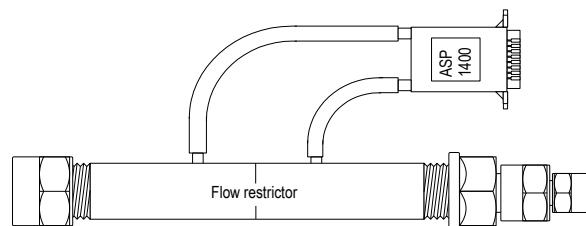

Figure 5: ASP1400 device using an example bypass configuration.

2 Pins and Digital Interface

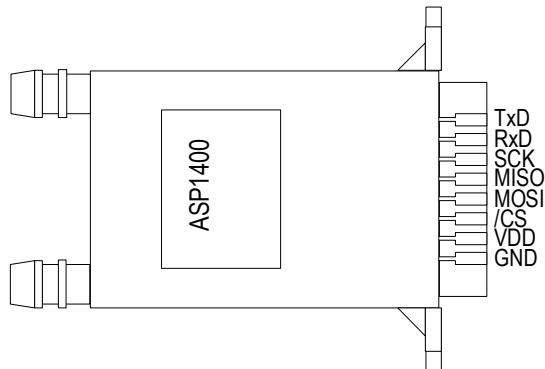

Figure 6: ASP1400 pin out.

GND and VDD (Power Supply)

The ASP1400 requires a voltage supply of between 7 V and 18 V. Since this voltage is internally regulated, there are no stringent requirements as far as ripple and stability are concerned.

2.1 Connector

You need an EDAC 395-010-520-102 connector to connect the sensor. Please check the EDAC homepage for details (www.edac.net).

Alternatively the AVX 00 6338 020 000 04 0 or AVX 00 6338 020 000 04 2 connectors can be used to connect the ASP1400 as well. (See www.farnell.com, order codes 635789 or 635730).

2.2 RS-232 Interface

All configurations (see also Section 3) for the ASP1400 can be set using its RS-232 interface. To

communicate with the ASP1400 via RS-232 the following pins are required:

RxD (Receiving Data Line)
TxD (Transmitting Data Line)
GND (Ground)

The RS-232 of the ASP1400 is configured as follows:

Baudrate	9600
Data Bits	8
Stop Bits	1
Parity	none
Protocol	none

With these settings, the ASP1400 device can be connected to any PC or PDA equipped with terminal software.

The measurement values are provided as a signed floating point number together with the corresponding unit (**Pa** for differential pressure, **C** for temperature). In case of an overflow, the output shows **oF**.

2.3 Serial Peripheral Interface (SPI)

The CMOSens[®] ASP1400 Differential Pressure Sensor has a bidirectional RS232 interface to set configuration and to get flow or temperature values. The in earlier versions available SPI interface is no longer specified, due to changed specifications of electronic components. If you require the SPI functionality, contact Sensirion.

3 Configuration and Commands

The ASP1400 device accepts a set of commands through its RS-232 interface (see table 3 for valid commands; for correct settings of the RS-232 refer to Section 2.2). This allows the user to configure the ASP1400 device. Since the configuration is stored in the internal EEPROM, it is maintained after power breaks.

With the exception of the stop command “**s**”, all commands have to be terminated by the return key (“**↵**”, ASCII #10 or #13). After completion of a command, the ASP1400 returns “**ok**” and is ready to take a new instruction. Before entering a command, it may be necessary to clear the buffer by means of using “**↵**”. There is a trade-off between resolution and measurement time. Possible settings are listed in Table 2. Choosing 12 bit results in a measurement interval of 142 ms. With the max resolution of 15.2 bit, a new measurement is provided every 1280 ms.

Table 2: Resolution settings using the **res=value** command and corresponding response times

res=	Resolution [bit]	Data interval [ms]
1	12.0	142
2	13.0	284
3	13.5	427
4	14.0	569
5	14.3	711
6	14.6	853
7	14.8	995
8	15.0	1138
9	15.2	1280

Table 3: Commands of the ASP1400 device.

Command	Output	Description
help↵	commands	Lists all available commands
ver↵	version	Provides type of sensor, software, hardware and customer version
get↵		Starts single measurement
go↵		Starts series of measurements
S	stop	Stops series of measurements
reset↵		Resets ASP1400 device
res=1..9↵	resolution	Sets resolution: 1 -> 12 bits; 9 -> 15 bits, see Table 2
res?	resolution	Shows actual setting
mod=F T↵	mode	Selects Differential Pressure mode (F) or Temperature mode (T)
mod?	mode	Shows actual setting
Disp=s,d	display mode	Shows Differential Pressure (s) or Differential Pressure + Temperature (d) *no effect in the Temperature mode
Disp?	display mode	Shows actual setting

Notes:

- Default settings are marked in **bold** letters
- The commands are not case sensitive.
- In order to send a new command to the ASP1400 make sure the ASP1400 is not in measurement mode. Issue therefore a stop command **s** first. After this, any instruction can be given to the ASP1400 and a new series of measurement can be started by **go↵**.
- Due to the limited write cycles allowed for the EEPROM, excessive configuration modifications should be avoided.

4 Specifications ASP1400

4.1 Absolute Maximum Ratings

Ambient storage temperature	-65°C to 150°C
Ambient operating temperature	0°C to 70°C
Overpressure resistance	1.5 bar

4.2 Electrical Specifications

Table 3: ASP1400 DC Characteristics.

Parameter	Conditions	Min.	Typ.	Max.	Units
Power Supply DC	DC	7	9	18	V
Operating Current	VDD = 9 V, no load		20		mA
	VDD = 9 V, 3kΩ at RS232 output		27		mA
Power Dissipation	VDD = 9 V, no load		180		mW

Table 4: ASP1400 RS-232 Characteristics.

Parameter	Conditions	Min.	Typ.	Max.	Units
RS232 Output					
Output Voltage Swing	Transmitter output loaded with 3kΩ	±5	±9		V
Power-Off Output Resistance		300			Ω
Output Short Circuit Current			±18		mA
RS-232 Input					
Voltage Range		-15		15	V
Voltage Threshold					
Low		0.8	1.2		V
High			1.7	2.4	V
Hysteresis		0.2	0.5	1.0	V
Resistance		3	5	7	kΩ

4.3 Electrical Grounding

It has to be ensured that the RS232-GND on PC side (pin 5 in D-Sub9 connector) is connected to GND of ASP1400 (see Figure 11). Otherwise, the potential difference between PC and power supply may damage the sensor's RS232 driver.

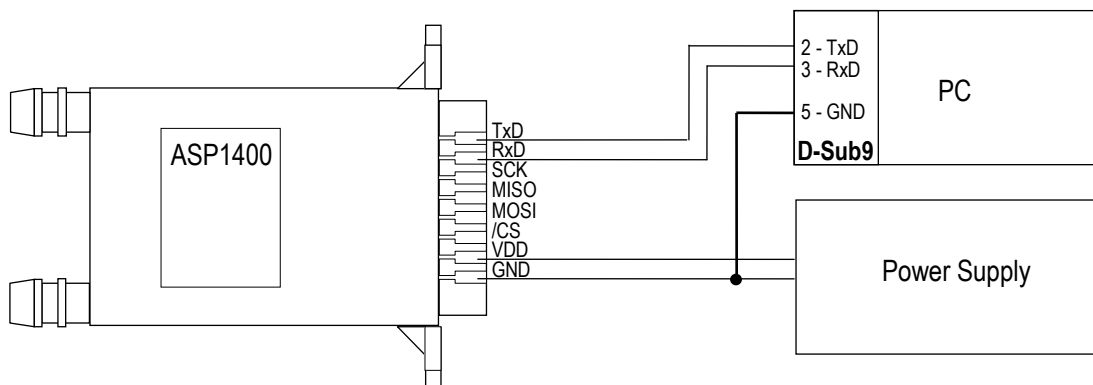

Figure 11: Electrical wiring diagram.

4.4 Contacting the Sensor

Please take care about the sequence of contacting the sensor's pins. If the voltage is supplied to RxD/TxD before VDD/GND, the RS232 driver does not operate properly. In this case, start up failure can occur.

5 Physical Dimensions and Mounting Information

The ASP1400 is mounted in chemically inert PBT housing. The rugged package has been designed to withstand over-pressures of up to 1 bar. For higher pressure packages of up to 10 bar, contact Sensirion.

Physical dimensions and mounting information are provided in Figure 12 and Table 6.

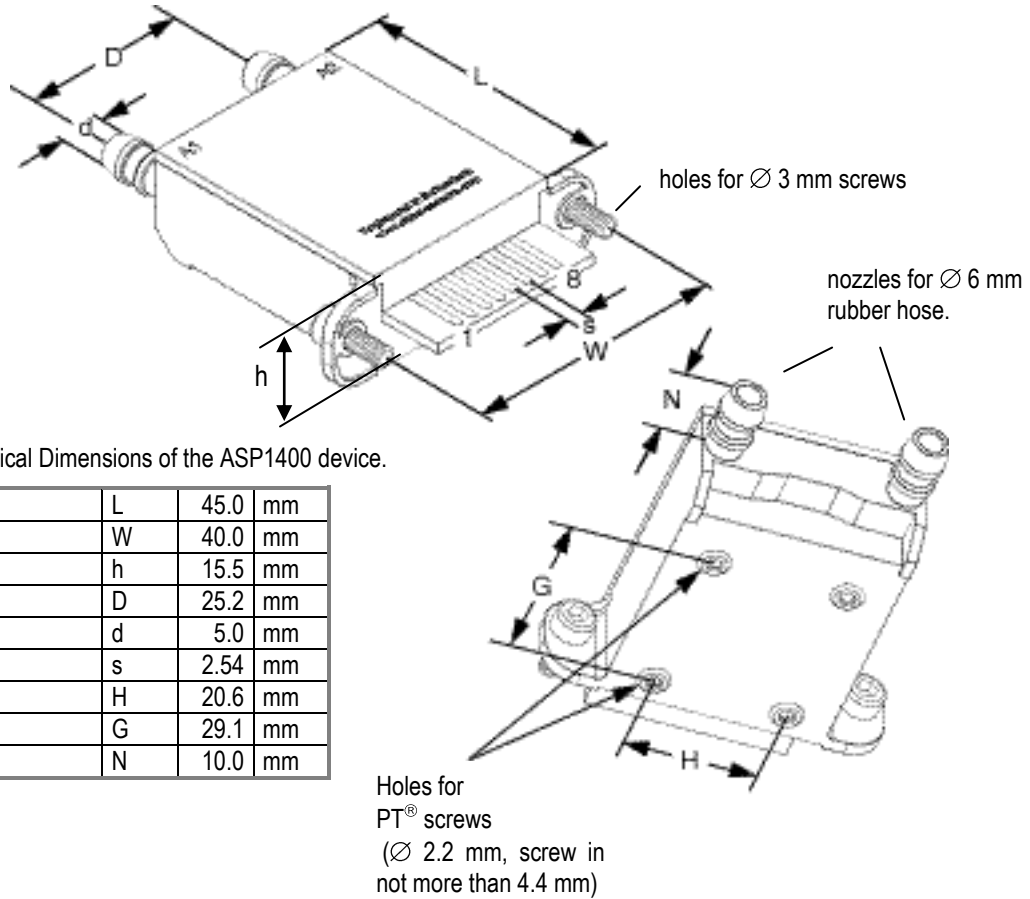

Table 6: Physical Dimensions of the ASP1400 device.

Length	L	45.0	mm
Width	W	40.0	mm
Height	h	15.5	mm
Distance	D	25.2	mm
Diameter	d	5.0	mm
Pitch	s	2.54	mm
Pitch	H	20.6	mm
Pitch	G	29.1	mm
Pitch	N	10.0	mm

Figure 12: Physical dimensions and mounting information of the ASP1400.

6 Ordering Information

For small ordering quantities the ASP1400 sensor can be ordered directly at Farnell on <http://www.farnell.com>. Farnell is a worldwide distributor of electrical, electronic and industrial component products.

When ordering ASP1400 series devices at SENSIRION please refer to the following part numbers. For the latest product information access SENSIRION's website on <http://www.sensirion.com>

Calibrated for Gas Type	Range	Packaging	SENSIRION Part Number
Synthetic air	± 100 Pa	2 bar	1-100012

Important Notices

Warning, personal injury

Do not use this product as safety or emergency stop devices or in any other application where failure of the product could result in personal injury. Do not use this product for applications other than its intended and authorized use. Before installing, handling, using or servicing this product, please consult the data sheet and application notes. Failure to comply with these instructions could result in death or serious injury.

If the Buyer shall purchase or use SENSIRION products for any unintended or unauthorized application, Buyer shall defend, indemnify and hold harmless SENSIRION and its officers, employees, subsidiaries, affiliates and distributors against all claims, costs, damages and expenses, and reasonable attorney fees arising out of, directly or indirectly, any claim of personal injury or death associated with such unintended or unauthorized use, even if SENSIRION shall be allegedly negligent with respect to the design or the manufacture of the product.

ESD Precautions

The inherent design of this component causes it to be sensitive to electrostatic discharge (ESD). To prevent ESD-induced damage and/or degradation, take customary and statutory ESD precautions when handling this product.

See application note "ESD, Latchup and EMC" for more information.

Warranty

SENSIRION warrants solely to the original purchaser of this product for a period of 12 months (one year) from the date of delivery that this product shall be of the quality, material and workmanship defined in SENSIRION's published specifications of the product. Within such period, if proven to be defective, SENSIRION shall repair and/or replace this product, in SENSIRION's discretion, free of charge to the Buyer, provided that:

- notice in writing describing the defects shall be given to SENSIRION within fourteen (14) days after their appearance;
- such defects shall be found, to SENSIRION's reasonable satisfaction, to have arisen from SENSIRION's faulty design, material, or workmanship;

- the defective product shall be returned to SENSIRION's factory at the Buyer's expense; and
- the warranty period for any repaired or replaced product shall be limited to the unexpired portion of the original period.

This warranty does not apply to any equipment which has not been installed and used within the specifications recommended by SENSIRION for the intended and proper use of the equipment. EXCEPT FOR THE WARRANTIES EXPRESSLY SET FORTH HEREIN, SENSIRION MAKES NO WARRANTIES, EITHER EXPRESS OR IMPLIED, WITH RESPECT TO THE PRODUCT. ANY AND ALL WARRANTIES, INCLUDING WITHOUT LIMITATION, WARRANTIES OF MERCHANTABILITY OR FITNESS FOR A PARTICULAR PURPOSE, ARE EXPRESSLY EXCLUDED AND DECLINED.

SENSIRION is only liable for defects of this product arising under the conditions of operation provided for in the data sheet and proper use of the goods. SENSIRION explicitly disclaims all warranties, express or implied, for any period during which the goods are operated or stored not in accordance with the technical specifications.

SENSIRION does not assume any liability arising out of any application or use of any product or circuit and specifically disclaims any and all liability, including without limitation consequential or incidental damages. All operating parameters, including without limitation recommended parameters, must be validated for each customer's applications by customer's technical experts. Recommended parameters can and do vary in different applications. SENSIRION reserves the right, without further notice, (i) to change the product specifications and/or the information in this document and (ii) to improve reliability, functions and design of this product.

Copyright© 2001-2008, SENSIRION.

CMOSens® is a trademark of Sensirion

All rights reserved

RoHS and WEEE Statement

The SDP6x0 family complies with requirements of the following directives:

- EU Directive 2002/96/EC on waste electrical and electronic equipment (**WEEE**), OJ13.02.2003; esp. its Article 6 (1) with Annex II.
- EU Directive 2002/95/EC on the restriction of the use of certain hazardous substances in electrical and electronic equipment (**RoHS**), OJ 13.02.2003; esp. its Article 4.

Revision history

Table 1: Revision history

Date	Version	Page(s)	Changes
April 2001		all	Primary datasheet
June 2005	V1.0	all	General revision
April 2008	V1.1	all	Overpressure resistance readapted SPI interface information removed New ISO-Logo, Sales Office Information and Disclaimer Connector information added
July 2011	V2.1	7,8	Electrical grounding Contacting the sensor

Headquarters and Sales Offices

Sensirion AG
 Laubisruetistrasse 50
 CH-8712 Staefa ZH
 Switzerland

Phone: + 41 44 306 40 00
 Fax: + 41 44 306 40 30
 e-mail: info@sensirion.com
 Web: www.sensirion.com



SENSIRION Inc
 Westlake Pl. Ctr. I, suite 240
 2801 Townsgate Road
 Westlake Village, CA 91361
 USA

Phone: +1 805-409 4900
 Fax: +1 805-435 0467
 e-mail: michael.karst@sensirion.com
 Web: www.sensirion.com

Sensirion Korea Co. Ltd.
 #1414, Anyang Construction Twr B/D
 1112-1, Bisan-dong, Anyang-city
 Gyeonggi-Province,
 South Korea

Phone: +82 31-440-9925~27
 Fax: +82 31-440-9927
 e-mail: info@sensirion.co.kr
 Web: www.sensirion.co.kr

SENSIRION Japan
 Sensirion Japan Co. Ltd.
 Shinagawa Station Bldg. 7F
 4-23-5 Takanawa
 Minato-ku, Tokyo, Japan

phone: +81 3-3444-4940
 fax: +81 3-3444-4939
 e-mail: info@sensirion.co.jp
 Web: www.sensirion.co.jp