





# SPECIFICATIONS

**CUSTOMER** : \_\_\_\_\_  
**MODEL NO.** : **GFA1602B-GPFE-JES**  
**VERSION** : **E**  
**DATE** : **2022.05.10**  
**CERTIFICATION** : **ROHS**

Customer Sign	Approved By	Prepared By	Prepared By
			

晶發科技股份有限公司  
GI FAR TECHNOLOGY CO.,LTD.

新北市樹林區東豐街 81 號

No. 81, Dongfeng St, Shulin District, 238034, New Taipei City, Taiwan, R.O.C.

TEL: +886-2-8684-1188 FAX: +886-2-8684-8532



### Revision Record

Data(y/m/d)	Ver.	Description	page
2012.03.03	A	Specification released	
2014.11.07	B	更新規格書 OPR1 跟 OPR2 之前狀態有誤正確為 OPR1=1 跟 OPR1=1	
2014.11.10	C	修正 Reliability 溫度範圍，符合圖面	10
2017.07.24	D	修改公司抬頭、格式統一	
2022.05.10	E	1.背光亮度範圍由原 min300cd/m <sup>2</sup> -typ400cd/m <sup>2</sup>	8
		變更為 min 500cd/m <sup>2</sup> -typ700cd/m <sup>2</sup> 2.增加包裝資訊	18



## CONTENTS

1.	Scope	-----	4
2.	Product Specifications	-----	4
2.1	General	-----	4
2.2	Mechanical Characteristics	-----	4
2.3	Absolute Maximum Ratings	-----	5
2.4	Electrical Characteristics	-----	5
2.5	Optical Characteristics Absolute maximum ratings	-----	6
2.6	Optical Characteristics	-----	7
2.7	LED Back-light Characteristics	-----	8
3.	Reliability	-----	9
4.	Operating Instructions	-----	10
4.1	Input signal Function	-----	10
4.2	Voltage Generator Circuit	-----	10
4.3	Timing Diagram	-----	11
4.4.	Display Command	-----	13
5	Character Pattern	-----	15
6	Notes	-----	16
7	Operation Precautions	-----	16
8	LCM Dimensions	-----	17
9	Package information	-----	18
	Appendix : Inspection Standard		



## 1. SCOPE

This specification covers the engineering requirements for the GFA1602B-GPFE-JES liquid crystal module.

## 2. PRODUCT SPECIFICATIONS

### 2.1 General

- 16 × 2 dot matrix LCD
- STN(Gray), Positive mode LCD panel
- Transflective , Wide temperature type
- 6 o'clock
- Multiplexing driving : 1/16duty, 1/5bias
- Controller IC : ST7032i-0D-G
- Backlight: White

### 2.2 Mechanical Characteristics

Item	Characteristic
Dot configuration	16 × 2
Dot dimensions(mm)	0.75 × 0.9
Dot spacing (mm)	0.79 × 0.97
Module dimensions (Horizontal × Vertical × Thickness, mm)	84 × 28 × 9Max
Viewing area (Horizontal × Vertical, mm)	76 × 18
Active area (Horizontal × Vertical, mm)	73.81 × 15.88
Remark	--



## 2.3 Absolute Maximum Ratings (Without LED back-light)

Characteristic	Symbol	Unit	Value
Operating Voltage (logic)	$V_{DD}$	V	-0.3 to +5.0
Input Voltage	$V_{IN}$	V	-0.3 to $V_{DD}+0.3$

Note 1: Referenced to  $V_{SS}=0V$

## 2.4 Electrical Characteristics (Without LED back-light)

(  $T_A = 25^{\circ}C$  ,  $V_{DD} = 2.7V - 4.5V$  )

Symbol	Characteristics	Test Condition	Min.	Typ.	Max.	Unit
$V_{DD}$	Operating Voltage	-	2.7	-	4.5	V
$V_{LCD}$	LCD Voltage	$V_0-V_{SS}$	2.7	-	7.0	V
$I_{CC}$	Power Supply Current	$V_{DD}=3.0V$ (Use internal booster/follower circuit)	-	160	230	$\mu A$
$V_{IH1}$	Input High Voltage (Except OSC1)	-	1.9	-	$V_{DD}$	V
$V_{IL1}$	Input Low Voltage (Except OSC1)	-	-0.3	-	0.8	V
$V_{IH2}$	Input High Voltage (OSC1)	-	0.7 $V_{DD}$	-	$V_{DD}$	V
$V_{IL2}$	Input Low Voltage (OSC1)	-	-	-	0.2 $V_{DD}$	V
$V_{OH1}$	Output High Voltage (DB0 - DB7)	$I_{OH} = -1.0mA$	0.75 $V_{DD}$	-	-	V
$V_{OL1}$	Output Low Voltage (DB0 - DB7)	$I_{OL} = 1.0mA$	-	-	0.8	V
$V_{OH2}$	Output High Voltage (Except DB0 - DB7)	$I_{OH} = -0.04mA$	0.8 $V_{DD}$	-	$V_{DD}$	V
$V_{OL2}$	Output Low Voltage (Except DB0 - DB7)	$I_{OL} = 0.04mA$	-	-	0.2 $V_{DD}$	V
$R_{COM}$	Common Resistance	$V_{LCD} = 4V, I_d = 0.05mA$	-	2	20	$K\Omega$
$R_{SEG}$	Segment Resistance	$V_{LCD} = 4V, I_d = 0.05mA$	-	2	30	$K\Omega$
$I_{LEAK}$	Input Leakage Current	$V_{IN} = 0V$ to $V_{DD}$	-1	-	1	$\mu A$
$I_{PUP}$	Pull Up MOS Current	$V_{DD} = 3V$	20	30	40	$\mu A$
fOSC	Oscillation frequency	$V_{DD} = 3V, 1/17duty$	350	540	1100	KHz



( TA = 25°C, VDD = 4.5 V - 5.5 V )

Symbol	Characteristics	Test Condition	Min.	Typ.	Max.	Unit
VDD	Operating Voltage	-	4.5	-	5.5	V
V <sub>LCD</sub>	LCD Voltage	V <sub>0</sub> -V <sub>ss</sub>	2.7	-	7.0	V
I <sub>CC</sub>	Power Supply Current	VDD=5.0V (Use internal booster/follower circuit)	-	240	340	uA
V <sub>IH1</sub>	Input High Voltage (Except OSC1)	-	2.7	-	VDD	V
V <sub>IL1</sub>	Input Low Voltage (Except OSC1)	-	-0.3	-	0.8	V
V <sub>IH2</sub>	Input High Voltage (OSC1)	-	0.7 VDD	-	VDD	V
V <sub>IL2</sub>	Input Low Voltage (OSC1)	-	-	-	1.0	V
V <sub>OH1</sub>	Output High Voltage (DB0 - DB7)	I <sub>OH</sub> = -1.0mA	3.8	-	VDD	V
V <sub>OL1</sub>	Output Low Voltage (DB0 - DB7)	I <sub>OL</sub> = 1.0mA	-	-	0.8	V
V <sub>OH2</sub>	Output High Voltage (Except DB0 - DB7)	I <sub>OH</sub> = -0.04mA	0.8 VDD	-	VDD	V
V <sub>OL2</sub>	Output Low Voltage (Except DB0 - DB7)	I <sub>OL</sub> = 0.04mA	-	-	0.2 VDD	V
R <sub>COM</sub>	Common Resistance	V <sub>LCD</sub> = 4V, I <sub>d</sub> = 0.05mA	-	2	20	KΩ
R <sub>SEG</sub>	Segment Resistance	V <sub>LCD</sub> = 4V, I <sub>d</sub> = 0.05mA	-	2	30	KΩ
I <sub>LEAK</sub>	Input Leakage Current	V <sub>IN</sub> = 0V to VDD	-1	-	1	μA
I <sub>PUP</sub>	Pull Up MOS Current	VDD = 5V	65	95	125	μA
f <sub>OSC</sub>	Oscillation frequency	VDD = 5V, 1/17duty	350	540	1100	KHz

## 2.5 Optical Characteristics Absolute maximum ratings

Item	Symbol	Rating	Unit
Operating temperature range	Top	-20~70	°C
Storage temperature range	Tst	-30~80	°C



## 2.6. Optical Characteristics

1/16 duty, 1/5 bias,  $V_{op}=4.5V$ ,  $T_a=25^\circ C$

Item	Symbol	Conditions	Min.	Typ.	Max	Reference
Driving voltage	$V_{op}$		4.2	4.5	4.8	
Viewing angle	$\theta_1$ 、 $\theta_2$	$C \geq 2.0, \phi = 0^\circ C$	$30^\circ$	-		Notes 1 & 2
Contrast	C	$\theta = 5^\circ, \phi = 0^\circ$	3.0	-	-	Note 3
Response time(rise)	$t_{on}$	$\theta = 5^\circ, \phi = 0^\circ$	-	96	250	Note 4
Response time(fall)	$t_{off}$	$\theta = 5^\circ, \phi = 0^\circ$	-	168	250	Note 4

Note 1: Definition of angles  $\theta$  and  $\phi$

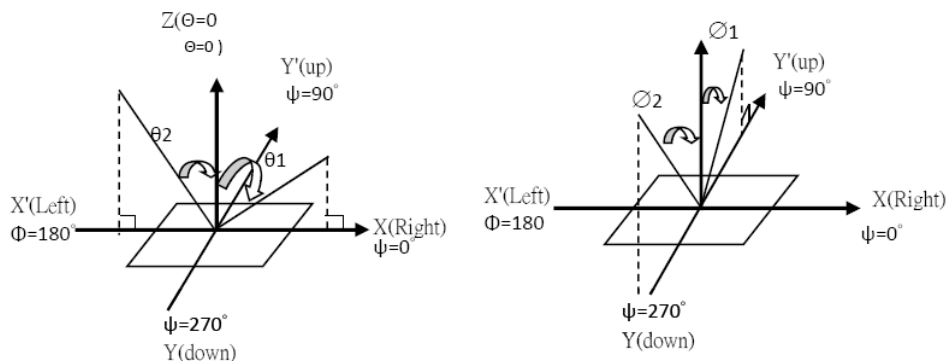

Note 2: Definition of viewing angles  $\theta_1$  and  $\theta_2$

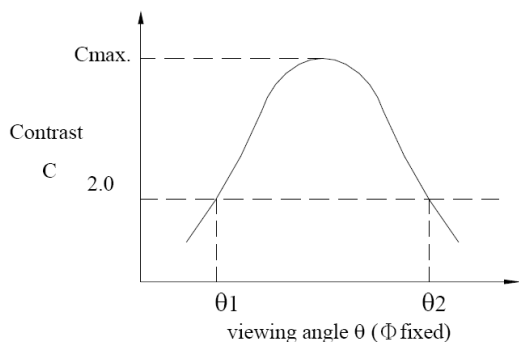

Note : Optimum viewing angle with the naked eye and viewing angle  $\theta$  at  $C_{max}$ . Above are not always the same

Note 3: Definition of contrast C

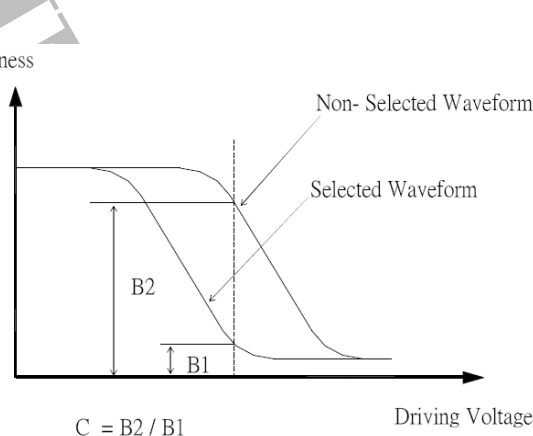

Note 4: Definition of response time

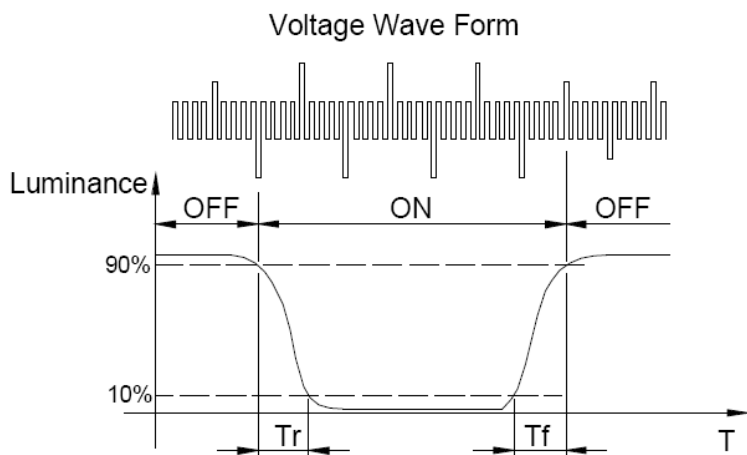



## 2.7 LED Back-light Characteristics

### 2.7.1 Electrical / optical specifications

Ta = 25°C

Item	Symbol	Condition	Min.	Typ.	Max.	Unit
Forward voltage	$V_f$	If=40mA, White	2.9	3.2	3.5	V
LED *Luminous Intensity	$I_v$	If=40mA, White	500	700	--	cd/m <sup>2</sup>
Chromaticity Coordinate	x	If=40mA, White	0.25	0.28	0.31	
	y		0.25	0.28	0.31	
Reverse Current	$I_R$	VR=5V, White	--	--	40	uA
Illuminance power deviation	$\Delta EH$	If=40mA, White	75			%

Note: \* Measured at the bare LED back-light unit.

### 2.7.2 LED Maximum Operating Range

Item	Symbol	White	Unit
Power Dissipation	$P_{AD}$	170	mW
Forward Current	$I_F$	50	mA
Reverse Voltage	$V_R$	5	V





### 3. RELIABILITY

NO.	ITEM	CONDITION		STANDARD	NOTE
1	High Temp. Storage	80°C	120 hrs	Appearance Without defect	
2	Low Temp. Storage	-30°C	120 hrs	Appearance Without defect	
3	High Temp. & High Humi. Storage	40°C 90% RH	120 hrs	Appearance Without defect	
4	High Temp. Operating Display	70°C	120 hrs	Appearance Without defect	
5	Low Temp. Operating Display	-20°C	120 hrs	Appearance Without defect	
6	Thermal Shock	-20°C, 30min. → 70°C, 30min. 		Appearance Without defect	10 cycles

\*\* Dissipation current, contrast and display functions

\*\* Polarizing filter deterioration, other appearance defects

\*\* The function test shall be conducted after 4hours storage at the normal temperature and humidity after remove from the test chamber.



## 4. OPERATING INSTRUCTIONS

### 4.1 Input signal Function

NO.	Symbol	Function
1	Vout	DC/DC voltage converter. Connect a capacity between this terminal and VDD when the built-in booster is used.
2	CAP1-	For voltage booster circuit(VDD-VSS) External capacitor about 0.1u~4.7uf
3	CAP1+	
4	VDD	Power Supply
5	VSS	Ground
6	SDA	Serial Data I/O
7	SCL	Serial Clock Input
8	RST	Reset Signal Input(Active Low)

### 4.2 Voltage Generator Circuit

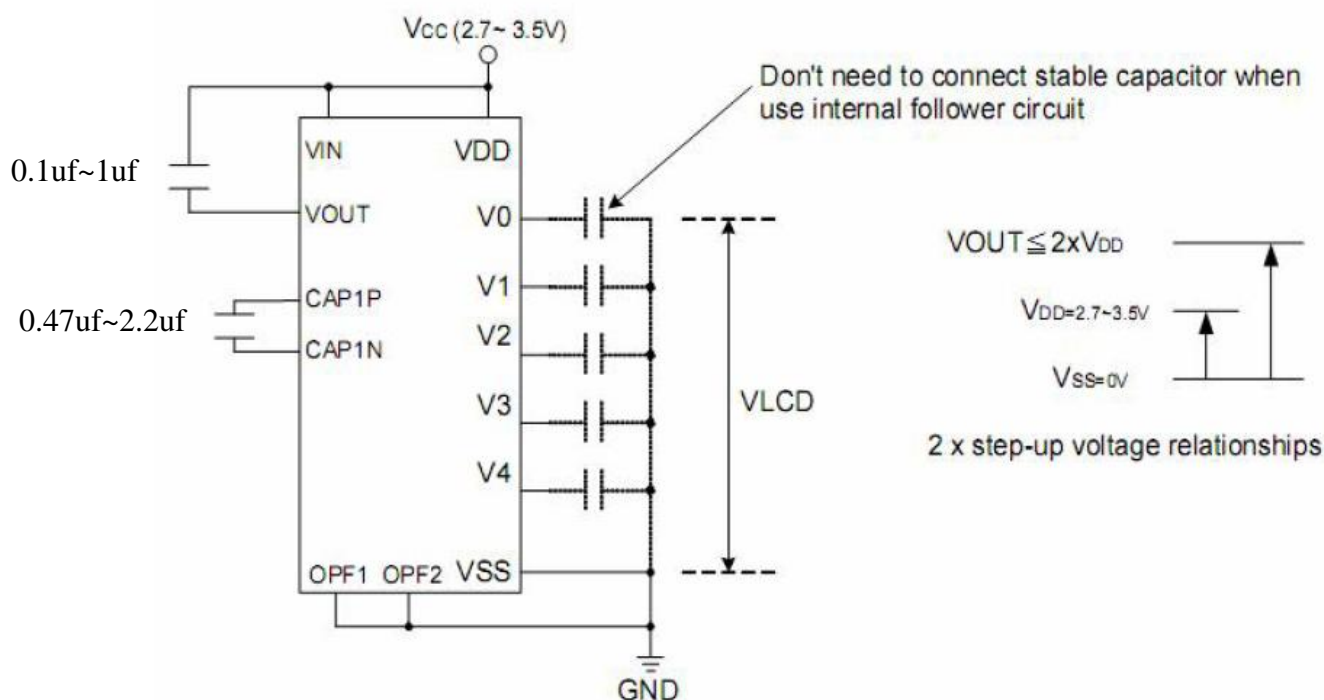



### 4.3 Timing Diagram

- I2C interface

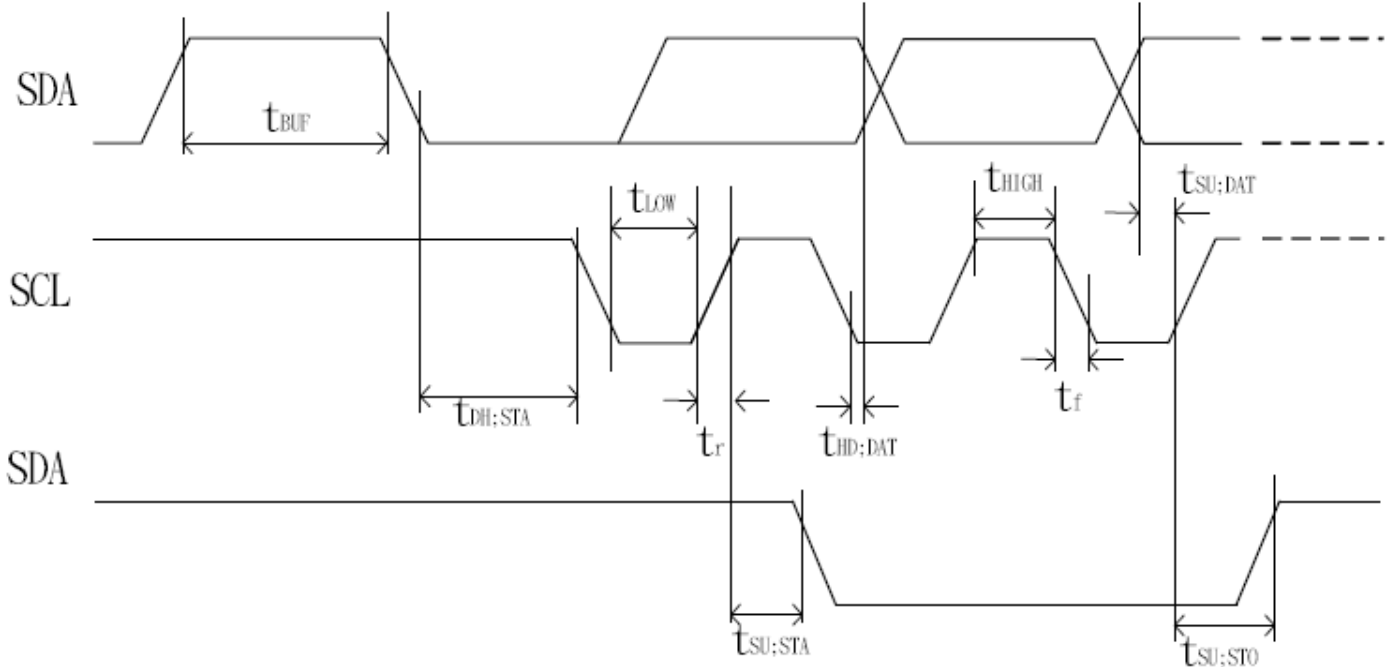

➤ Intel 8051 interface( I<sup>2</sup>C )

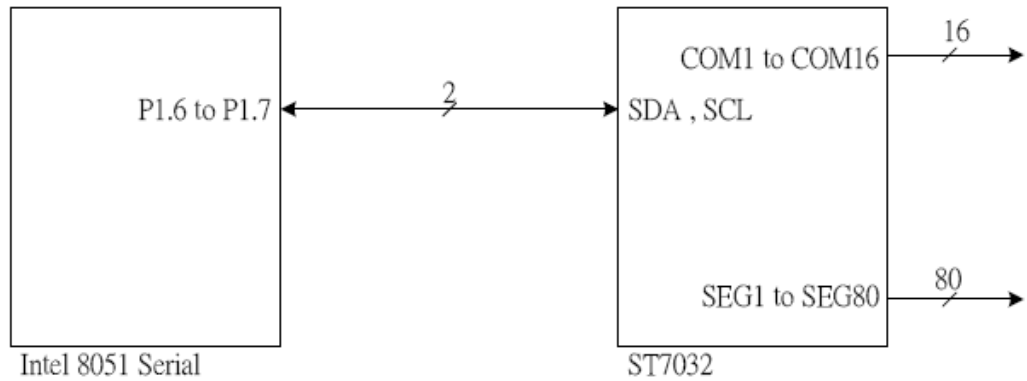



( Ta = -30°C to 85°C )

Item	Signal	Symbol	Condition	VDD=2.7 to 4.5V Rating		VDD=4.5 to 5.5V Rating		Units
				Min.	Max.	Min.	Max.	
SCL clock frequency	SCL	$f_{SCLK}$	—	DC	400	DC	400	KHz
SCL clock low period		$t_{LOW}$		1.3	—	1.3	—	us
SCL clock high period		$t_{HIGH}$		0.6	—	0.6	—	
Data set-up time	SI	$t_{SU:DAT}$	—	<b>180</b>	—	100	—	ns
Data hold time		$t_{HD:DAT}$		0	0.9	0	0.9	us
SCL, SDA rise time	SCL, SDA	$t_r$	—	20+0.1C <sub>b</sub>	300	20+0.1C <sub>b</sub>	300	ns
SCL, SDA fall time		$t_f$		20+0.1C <sub>b</sub>	300	20+0.1C <sub>b</sub>	300	
Capacitive load represent by each bus line		C <sub>b</sub>	—	—	400	—	400	pf
Setup time for a repeated START condition	SI	$t_{SU:STA}$	—	0.6	—	0.6	—	us
Start condition hold time		$t_{HD:STA}$	—	0.6	—	0.6	—	us
Setup time for STOP condition		$t_{SU:STO}$	—	0.6	—	0.6	—	us
Bus free time between a Stop and START condition	SCL	$t_{BUF}$	—	1.3	—	1.3	—	us

CONFIDENTIAL



#### 4.4.Display Command

➤ instruction table at “Normal mode”

(When “EXT” option pin connect to VDD, the instruction set follow below table)

Instruction	Instruction Code										Description	Instruction Execution Time		
	RS	R/W	DB7	DB6	DB5	DB4	DB3	DB2	DB1	DB0		OSC= 380KHz	OSC= 540kHz	OSC= 700KHz
Clear Display	0	0	0	0	0	0	0	0	0	1	Write "20H" to DDRAM. and set DDRAM address to "00H" from AC	1.08 ms	0.76 ms	0.59 ms
Return Home	0	0	0	0	0	0	0	0	1	x	Set DDRAM address to "00H" from AC and return cursor to its original position if shifted. The contents of DDRAM are not changed.	1.08 ms	0.76 ms	0.59 ms
Entry Mode Set	0	0	0	0	0	0	0	1	I/D	S	Sets cursor move direction and specifies display shift. These operations are performed during data write and read.	26.3 us	18.5 us	14.3 us
Display ON/OFF	0	0	0	0	0	0	1	D	C	B	D=1:entire display on C=1:cursor on B=1:cursor position on	26.3 us	18.5 us	14.3 us
Cursor or Display Shift	0	0	0	0	0	1	S/C	R/L	x	x	S/C and R/L: Set cursor moving and display shift control bit, and the direction, without changing DDRAM data.	26.3 us	18.5 us	14.3 us
Function Set	0	0	0	0	1	DL	N	x	x	x	DL: interface data is 8/4 bits N: number of line is 2/1	26.3 us	18.5 us	14.3 us
Set CGRAM	0	0	0	1	AC5	AC4	AC3	AC2	AC1	AC0	Set CGRAM address in address counter	26.3 us	18.5 us	14.3 us
Set DDRAM address	0	0	1	AC6	AC5	AC4	AC3	AC2	AC1	AC0	Set DDRAM address in address counter	26.3 us	18.5 us	14.3 us
Read Busy flag and address	0	1	BF	AC6	AC5	AC4	AC3	AC2	AC1	AC0	Whether during internal operation or not can be known by reading BF. The contents of address counter can also be read.	0	0	0
Write data to RAM	1	0	D7	D6	D5	D4	D3	D2	D1	D0	Write data into internal RAM (DDRAM/CGRAM)	26.3 us	18.5 us	14.3 us
Read data from RAM	1	1	D7	D6	D5	D4	D3	D2	D1	D0	Read data from internal RAM (DDRAM/CGRAM)	26.3 us	18.5 us	14.3 us



➤ instruction table at "Extension mode"  
(when "EXT" option pin connect to VSS, the instruction set follow below table)

Instruction	Instruction Code										Description	Instruction Execution Time		
	RS	R/W	DB7	DB6	DB5	DB4	DB3	DB2	DB1	DB0		OSC=380KHz	OSC=540kHz	OSC=700KHz
Clear Display	0	0	0	0	0	0	0	0	0	1	Write "20H" to DDRAM. and set DDRAM address to "00H" from AC	1.08 ms	0.76 ms	0.59 ms
Return Home	0	0	0	0	0	0	0	0	1	x	Set DDRAM address to "00H" from AC and return cursor to its original position if shifted. The contents of DDRAM are not changed.	1.08 ms	0.76 ms	0.59 ms
Entry Mode Set	0	0	0	0	0	0	0	1	I/D	S	Sets cursor move direction and specifies display shift. These operations are performed during data write and read.	26.3 us	18.5 us	14.3 us
Display ON/OFF	0	0	0	0	0	0	1	D	C	B	D=1:entire display on C=1:cursor on B=1:cursor position on	26.3 us	18.5 us	14.3 us
Function Set	0	0	0	0	1	DL	N	DH	*0	IS	DL: interface data is 8/4 bits N: number of line is 2/1 DH: double height font IS: instruction table select	26.3 us	18.5 us	14.3 us
Set DDRAM address	0	0	1	AC6	AC5	AC4	AC3	AC2	AC1	AC0	Set DDRAM address in address counter	26.3 us	18.5 us	14.3 us
Read Busy flag and address	0	1	BF	AC6	AC5	AC4	AC3	AC2	AC1	AC0	Whether during internal operation or not can be known by reading BF. The contents of address counter can also be read.	0	0	0
Write data to RAM	1	0	D7	D6	D5	D4	D3	D2	D1	D0	Write data into internal RAM (DDRAM/CGRAM/ICONRAM)	26.3 us	18.5 us	14.3 us
Read data from RAM	1	1	D7	D6	D5	D4	D3	D2	D1	D0	Read data from internal RAM (DDRAM/CGRAM/ICONRAM)	26.3 us	18.5 us	14.3 us

Note \* : this bit is for test command , and must always set to "0"

Instruction table 0(IS=0)														
Cursor or Display Shift	0	0	0	0	0	1	S/C	R/L	x	x	S/C and R/L: Set cursor moving and display shift control bit, and the direction, without changing DDRAM data.	26.3 us	18.5 us	14.3 us
Set CGRAM	0	0	0	1	AC5	AC4	AC3	AC2	AC1	AC0	Set CGRAM address in address counter	26.3 us	18.5 us	14.3 us

Instruction table 1(IS=1)														
Internal OSC frequency	0	0	0	0	0	1	BS	F2	F1	F0	BS=1:1/4 bias BS=0:1/5 bias F2~0: adjust internal OSC frequency for FR frequency.	26.3 us	18.5 us	14.3 us
Set ICON address	0	0	0	1	0	0	AC3	AC2	AC1	AC0	Set ICON address in address counter.	26.3 us	18.5 us	14.3 us
Power/ICON control/Contrast set	0	0	0	1	0	1	Ion	Bon	C5	C4	Ion: ICON display on/off Bon: set booster circuit on/off C5,C4: Contrast set for internal follower mode.	26.3 us	18.5 us	14.3 us
Follower control	0	0	0	1	1	0	Fon	Rab2	Rab1	Rab0	Fon: set follower circuit on/off Rab2~0: select follower amplified ratio.	26.3 us	18.5 us	14.3 us
Contrast set	0	0	0	1	1	1	C3	C2	C1	C0	Contrast set for internal follower mode.	26.3 us	18.5 us	14.3 us



## 5. Character Pattern

ST7032-0D (ITO option OPR1=1, OPR2=1)

b7-b4 b3-b0	0000	0001	0010	0011	0100	0101	0110	0111	1000	1001	1010	1011	1100	1101	1110	1111
0000	0	1	2	3	4	5	6	7	8	9	A	B	C	D	E	F
0001	J	k	l	m	n	o	p	q	r	s	t	u	v	w	x	y
0010	z	[	\	]	^	_	0	1	2	3	4	5	6	7	8	9
0011	P	q	r	s	t	u	v	w	x	y	z	[	\	]	^	_
0100	4	5	6	7	8	9	A	B	C	D	E	F	G	H	I	J
0101	k	l	m	n	o	p	q	r	s	t	u	v	w	x	y	z
0110	0	1	2	3	4	5	6	7	8	9	A	B	C	D	E	F
0111	G	H	I	J	K	L	M	N	O	P	Q	R	S	T	U	V
1000	W	X	Y	Z	[	\	]	^	_	0	1	2	3	4	5	6
1001	7	8	9	A	B	C	D	E	F	G	H	I	J	K	L	M
1010	N	O	P	Q	R	S	T	U	V	W	X	Y	Z	[	\	]
1011	^	_	0	1	2	3	4	5	6	7	8	9	A	B	C	D
1100	E	F	G	H	I	J	K	L	M	N	O	P	Q	R	S	T
1101	U	V	W	X	Y	Z	[	\	]	^	_	0	1	2	3	4
1110	5	6	7	8	9	A	B	C	D	E	F	G	H	I	J	K
1111	L	M	N	O	P	Q	R	S	T	U	V	W	X	Y	Z	[



## 6. NOTES

### ▪ Safety

- If the LCD panel breaks, be careful not to get the liquid crystal in your mouth. If the liquid crystal touches your skin or clothes, wash it off immediately using soap and plenty of water.

### Handling

- Avoid static electricity as this can damage the CMOS LSI.
- The LCD panel is plate glass; do not hit or crush it.
- Do not remove the panel or frame from the module.
- The polarizing plate of the display is very fragile; handle it very carefully

### Mounting and Design

- Mount the module by using the specified mounting part and holes.
- To protect the module from external pressure, leave a small gap by placing transparent plates (e.g. acrylic or glass ) on the display surface, frame, and polarizing plate
- Design the system so that no input signal is given unless the power-supply voltage is applied.
- Keep the module dry. Avoid condensation, otherwise the transparent electrodes may break.

### Storage

- Store the module in a dark place where the temperature is  $25^{\circ}\text{C} \pm 10^{\circ}\text{C}$  and the humidity below 65% RH.
- Do not store the module near organic solvents or corrosive gases.
- Do not crush, shake, or jolt the module (including accessories).

### Cleaning

- Do not wipe the polarizing plate with a dry cloth, as it may scratch the surface.
- Wipe the module gently with soft cloth soaked with a petroleum benzine.
- Do not use ketonic solvents (ketone and acetone) or aromatic solvents (toluene and xylene), as they may damage the polarizing plate.

## 7. OPERATION PRECAUTIONS

Any changes that need to be made in this specification or any problems arising from it will be dealt with quickly by discussion between both companies.

Quality warranty period: Within one year after shipment date (excluding abnormal usage way and abnormal environments.)





## 8. LCM Dimension

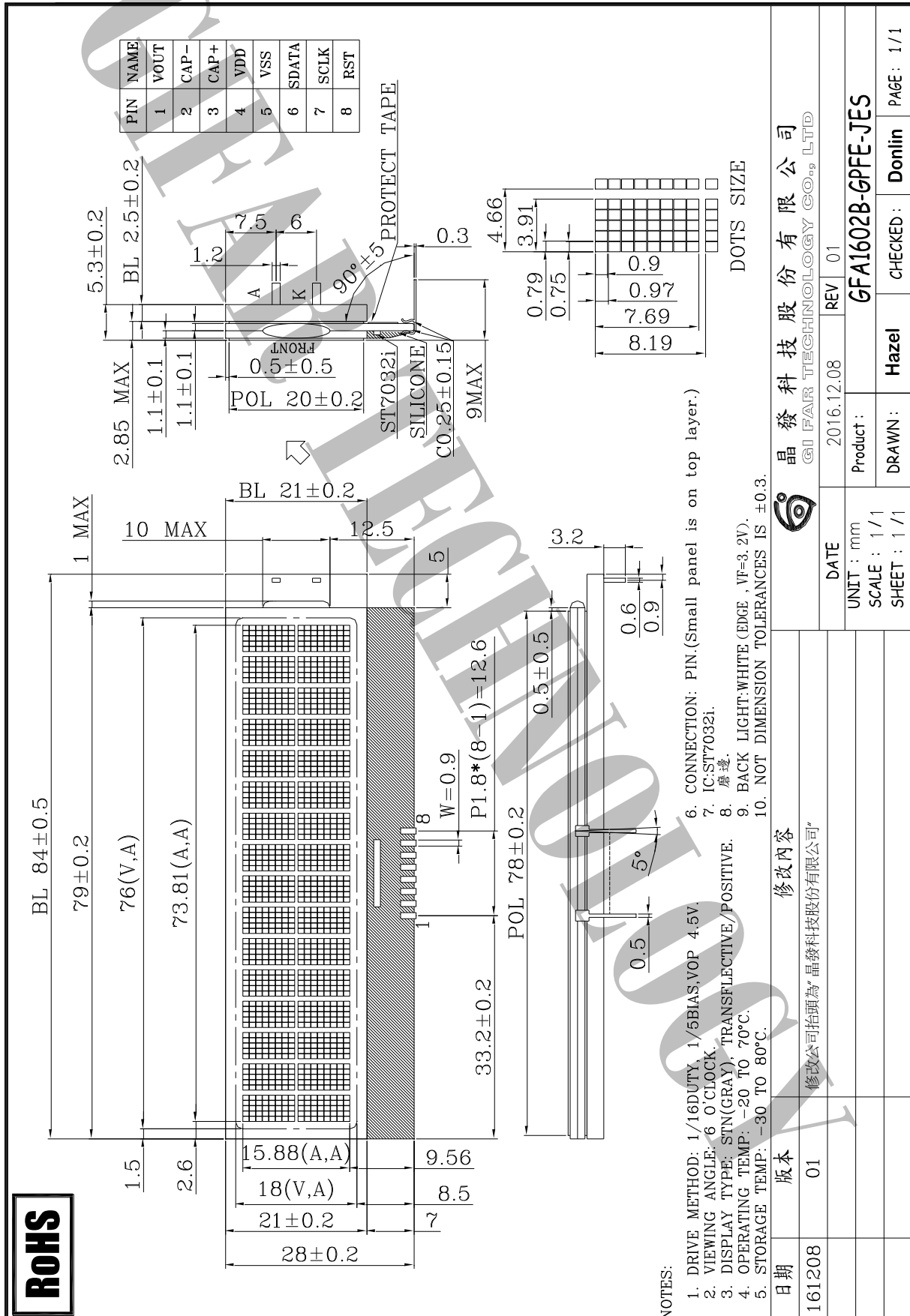



## 9. PACKAGE INFORMATION

1	1 Tray	:	20 pcs (modules)
2	1 stack	:	9 tray +1 Cover tray
3	1 Carton	:	(1 Cover tray + 9 tray )x 3 stack
4	Total pcs	:	1 Carton (20pcs* 9tray * 3 stack) = 540 pcs
5	Carton size = NO. 17	:	495*315*435mm
7	Net weight	:	7.29 KG
8	Gross weight	:	10.9 KG

\*\* Packaging information\*\*

- 1 Tray = 20 pcs

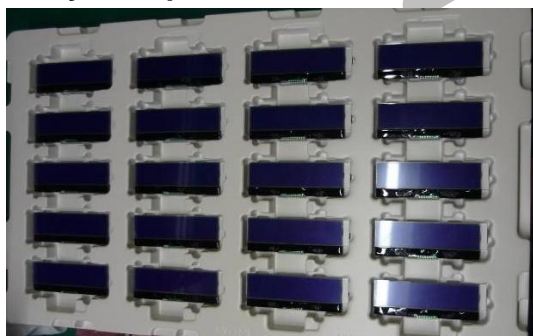

- 1 stack= 9 tray+1 Cover tray



\*\*Each layer of tray should be staggered stacked



- 1 Carton = 3 stack, Total pcs = 540 pcs



出貨檢驗標準書  
Shipping inspection standard

核准 Approved by	審核 Checked by	作成 Made by
ANDY	JACKY	RUBY

**1.目的 Purpose :**

規範出貨產品之檢驗項目及判斷標準，確保產品出貨能滿足客戶要求。

Standardize the inspection items and judgment standards to ensure the products that shipped out can meet customer's requirements.

**2.範圍 Area :**

適用於出廠之所有產品。

Applicable to all products shipped from the factory.

**3.名詞解釋 Explanation of terms :**

3-1 主要缺陷：亦會造成功能缺失或嚴重外觀缺陷。

Major Defects: It also causes loss of function or serious appearance defects.

3-2 次要缺陷：稍有缺陷但不影響客戶使用。

Minor defect: Slightly defective but does not affect customer use.

**4.檢驗體制 Inspection system :**

4-1 抽樣計劃：依 ANSI/ASQ Z1.4 一般檢驗水準 II 之 正常檢驗一次抽驗方案。

Sampling plan: According to ANSI/ASQ Z1.4 general inspection level II the normal inspection one-time sampling plan.

4-2 允收水準 Acceptable Level : (AQL)

主要缺陷 Major defect : 0.4 %

次要缺陷 Minor defect : 0.65 %

**5.檢驗條件 Inspection conditions :**

5-1 使用相關之檢測儀器及測試、量測工具。

Use relevant testing instrument, testing and measuring tools .

5-2 環境要求：其條件需控制在常溫下  $23^{\circ}\text{C}\pm 3^{\circ}\text{C}$  及溼度 70%RH 以下。

Environmental requirements: The conditions should be controlled at room temperature  $23^{\circ}\text{C}\pm 3^{\circ}\text{C}$  and humidity below 70%RH.

5-3 外觀檢驗：須在  $380\pm 20\%$  LUX 的白色日光燈下，其目視距離需於產品離  $30\pm 5$  cm 檢驗。

Appearance inspection: Under the white fluorescent lamp of  $380\pm 20\%$  LUX , the visual distance shall be checked above the product  $30 \pm 5$  cm.

5-4 電性測試 Electrical Testing :

5-4-1 有背光之產品需關燈並在  $5\sim 300\text{Lux}\pm 3\%$  下檢驗。

The products with backlight should be tested at  $5\sim 300\pm 3\%$  Lux.

5-4-2 無背光之產品需開燈並在  $60\sim 300\text{Lux}\pm 3\%$  白色日光燈下檢驗。

Products without backlight need to be turned on and tested under  $60\sim 300 \pm 3\%$  LUX white fluorescent lamps .

5-5 檢查視角依產品視角方向。

Check the viewing angle according to the product viewing angle.

5-6 其不良現象檢視區域 Bad phenomenon View area

5-6-1 適用種類 Applicable category : COB、TFT

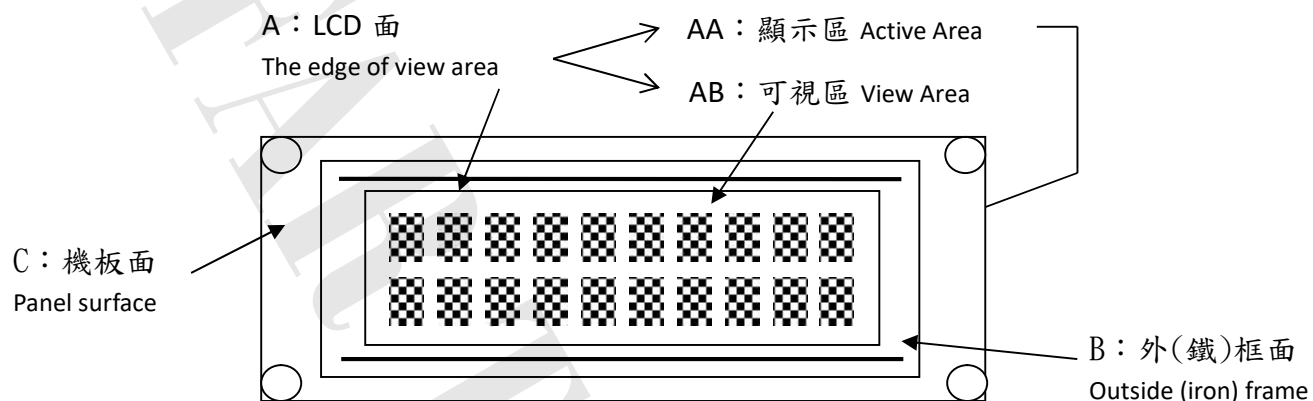

5-6-2 適用種類 Applicable category : COG、TAB、TN

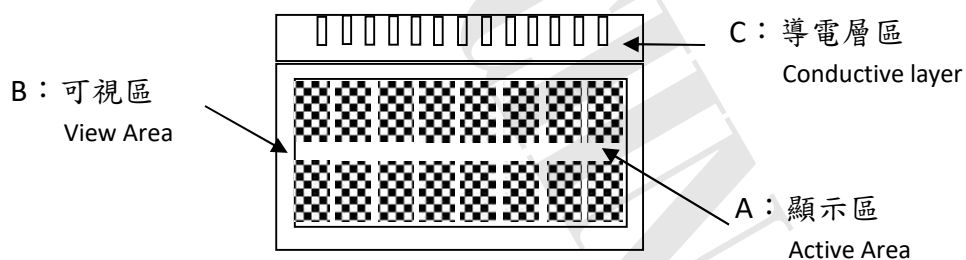

種類 Category		COG																			
編號 No.	檢驗項目 Item	檢驗內容及判定標準 Inspection Content & Standard			區域 Zone	類別 Category	缺陷等級 Level														
1	點類(一) Dot(1)	黑點、刺傷...等圓狀 Black dot、Stab...and other round shape $\phi = \frac{(X + Y)}{2}$ 	兩點距離須超過 5 mm Two points have to be $\geq 5$ mm		A B	外觀 Appearance	次要 Minor AQL0.65%														
		$\phi$ (mm)	允收數 Acceptance Qty																		
		$\phi \leq 0.1$	無視 Ignore																		
		$0.1 < \phi \leq 0.25$	3																		
		$0.25 < \phi \leq 0.3$	1																		
		$\phi > 0.3$	0																		
2	點類(二) Dot(2)	氣泡、凹凸點 Bubble、Uneven dots $\phi = \frac{(X + Y)}{2}$ 	兩點距離須超過 5 mm Two points have to be $\geq 5$ mm		A B	外觀 Appearance	次要 Minor AQL0.65%														
		$\phi$ (mm)	允收數 Acceptance Qty																		
		$\phi \leq 0.2$	無視 Ignore																		
		$0.2 < \phi \leq 0.5$	2																		
		$\phi > 0.5$	0																		
3	線類 Line	刮傷、毛屑...等線狀 Scratch、Fiber.. and other linear shape. 	<table border="1"> <thead> <tr> <th>L (mm)</th> <th>W (mm)</th> <th>允收數 Acceptance Qty</th> </tr> </thead> <tbody> <tr> <td>--</td> <td><math>W \leq 0.02</math></td> <td>無視 Ignore</td> </tr> <tr> <td><math>L \leq 5</math></td> <td><math>W \leq 0.03</math></td> <td>3</td> </tr> <tr> <td><math>L \leq 3</math></td> <td><math>W \leq 0.05</math></td> <td>2</td> </tr> <tr> <td><math>L &gt; 5</math></td> <td><math>W &gt; 0.05</math></td> <td>0</td> </tr> </tbody> </table>	L (mm)	W (mm)	允收數 Acceptance Qty	--	$W \leq 0.02$	無視 Ignore	$L \leq 5$	$W \leq 0.03$	3	$L \leq 3$	$W \leq 0.05$	2	$L > 5$	$W > 0.05$	0	A B	外觀 Appearance	次要 Minor AQL0.65%
L (mm)	W (mm)	允收數 Acceptance Qty																			
--	$W \leq 0.02$	無視 Ignore																			
$L \leq 5$	$W \leq 0.03$	3																			
$L \leq 3$	$W \leq 0.05$	2																			
$L > 5$	$W > 0.05$	0																			
4	底色 Background color	同批供貨不能有明顯色差 No obvious color difference allowed in same shipment. (必要時與客端制定限度樣) (According to the gold samples if necessary)			B	外觀 Appearance	次要 Minor AQL0.65%														
5	FPC 外觀 FPC Appearance	※ FPC 上刺傷導致線路無法導通 拒收 Stabbing on the FPC causes the line to fail to conduct Reject ※ FPC 上髒污或是殘留異物以致線路無法導通 拒收 Dirty or residual foreign matter on the FPC makes the circuit unable to conduct Reject ※ FPC 直角折痕、斷裂 拒收 FPC right-angle crease and fracture Reject			C	外觀 Appearance	主要 Major AQL 0.4%														

6	點、線類 (三) Dot、Line (3)	※ 於全黑、白畫面下看見之區塊狀或線狀不良 拒收 There is a block or linear in the view area under the screen is whole black or white. Reject ※ 但依 2% ND Filter 遮蓋無視 允收 But after inspecting by 2% ND Filter without seeing block or linear, it is confirmed Acceptance	A	電訊 Electronics	次要 Minor AQL0.65%
7	點、線類 (四) Dot、Line (4)	畫面中顯示出現黑、白、亮、異色點或線狀 There is a black, white, bright or other dot or lines showing in the view area. ※ 依編號 1、3 之判定標準 According to the inspection standard: No. 1 and 3.	A	電訊 Electronics	次要 Minor AQL0.65%
8	缺字 Lack of characters	顯示時畫面缺少部份字元 拒收 Lacking part of characters in the view area. Reject	A	電訊 Electronics	主要 Major AQL 0.4%
9	無動作 No reaction	顯示畫面一直處於起始畫面而無法進行切換 拒收 The display (view area) always show in the initial screen and can't be switched to others. Reject	A	電訊 Electronics	主要 Major AQL 0.4%
10	無畫面 No display	通電後，完全無任何畫面顯示 拒收 After connecting to the power, there is no image. Reject	A	電訊 Electronics	主要 Major AQL 0.4%
11	斷線 Broken line	顯示畫面中少直、橫線 拒收 There is a lack of vertical or horizontal lines in the view area. Reject	A	電訊 Electronics	主要 Major AQL 0.4%
12	CROSS TALK	顯示畫面時有局部之條紋或拖影 There are some stripes or shadow/smear showing in the view area. 拒收或與客端簽訂限度樣 Reject or inspect according to the golden sample	A	電訊 Electronics	次要 Minor AQL0.65%
13	I CON	顯示畫面缺少部份顯示圖案 拒收 Lack of partial ICON in the view area. Reject	A	電訊 Electronics	主要 Major AQL 0.4%

14	深淺不一 Color difference	顯示畫面的對比，比其他顯示深或淺並依電氣規格(VOP)值判定 The color contrast of display is obviously lighter or darker than others and according to the VOP value in the electronics specification. 拒收或與客端簽訂限度樣 Reject or inspect according to the golden sample	A	電訊 Electronics	次要 Minor AQL0.65%												
15	畫面異常 Abnormal screen	通電後畫面出現未定義之電訊不良現象 拒收 After connecting to the power, there is an undefined electronics appearance showing in the view area. Reject	A	電訊 Electronics	主要 Major AQL 0.4%												
16	背光色不均 Uneven color of backlight	※ 點亮後 LED 有明暗不均現象依其均勻度判定 拒收 After lighting LEDs have brightness and darkness uneven the determined according to its uniformity. Reject ※ 點亮後 LED 色澤不一致 拒收 LED color is inconsistent after lighting. Reject	A	電訊 Electronics	次要 Minor AQL0.65%												
17	亮度不足 Lack of brightness	波長、色座標、輝度與圖面標示定義不符 拒收 Wave length, chromatic coordinates, brightness don't correspond to the definition of the drawing. Reject	A	電訊 Electronics	主要 Major AQL 0.4%												
18	背光腳柱 Backlit foot post	斷裂、長度不一 拒收 Fracture, different length Reject	--	外觀 Appearance	次要 Minor AQL0.65%												
19	破損 Damaged	<p>Y：破損寬 X：破損長 Y: Damaged width X: Damaged length</p>  <table border="1"> <thead> <tr> <th>Y</th> <th>X</th> <th>判定 Determination</th> </tr> </thead> <tbody> <tr> <td>Y ≤ 1.0</td> <td>-- --</td> <td>允收 Acceptance</td> </tr> <tr> <td>未進入可視區 Did not enter the viewing area</td> <td>≤ 1/8 玻璃該邊長 ≤ 1/8 The side length of the glass</td> <td>允收 Acceptance</td> </tr> <tr> <td>進入可視區 Enter the viewing area</td> <td>-- --</td> <td>拒收 Reject</td> </tr> </tbody> </table>	Y	X	判定 Determination	Y ≤ 1.0	-- --	允收 Acceptance	未進入可視區 Did not enter the viewing area	≤ 1/8 玻璃該邊長 ≤ 1/8 The side length of the glass	允收 Acceptance	進入可視區 Enter the viewing area	-- --	拒收 Reject	B	外觀 Appearance	次要 Minor AQL0.65%
Y	X	判定 Determination															
Y ≤ 1.0	-- --	允收 Acceptance															
未進入可視區 Did not enter the viewing area	≤ 1/8 玻璃該邊長 ≤ 1/8 The side length of the glass	允收 Acceptance															
進入可視區 Enter the viewing area	-- --	拒收 Reject															

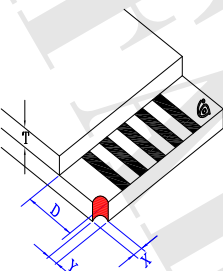

20	角崩 Corner collapse		Y：破損寬 X：破損長 Y: Damaged width X: Damaged length <table border="1" data-bbox="566 537 1109 846"> <thead> <tr> <th>Y</th> <th>X</th> <th>判定 Determination</th> </tr> </thead> <tbody> <tr> <td><math>\leq 1/3D</math></td> <td>-- --</td> <td>允收 Acceptance</td> </tr> <tr> <td><math>1/3D &lt; Y \leq D</math></td> <td><math>\leq 1/8</math> 玻璃邊長 <math>\leq 1/8</math> The side length of the glass</td> <td>允收 Acceptance</td> </tr> <tr> <td><math>&gt; D</math></td> <td>-- --</td> <td>拒收 Reject</td> </tr> </tbody> </table>	Y	X	判定 Determination	$\leq 1/3D$	-- --	允收 Acceptance	$1/3D < Y \leq D$	$\leq 1/8$ 玻璃邊長 $\leq 1/8$ The side length of the glass	允收 Acceptance	$> D$	-- --	拒收 Reject	C	外觀 Appearance	次要 Minor AQL0.65%
Y	X	判定 Determination																
$\leq 1/3D$	-- --	允收 Acceptance																
$1/3D < Y \leq D$	$\leq 1/8$ 玻璃邊長 $\leq 1/8$ The side length of the glass	允收 Acceptance																
$> D$	-- --	拒收 Reject																
21	尺寸量測 Size Measurement	未依圖面上標示 拒收 No correspond to the indication on the drawing. Reject		ALL	外觀 Appearance	主要 Major AQL 0.4%												
22	其他 Other	如發現有上述未定義之不良則與客端簽訂限度樣 If there is another undefined defective situation. It will be listed as others. The inspection standard is according to the golden sample.		ALL	電訊 Electronics 外觀 Appearance	次要 Minor AQL0.65%												