

APPROVED: _____
 DATE: _____ TITLE: _____

Rev	AWO #	Description	Date	Appr
-		RELEASED	3/22/18	
A		UPDATED DRAWING	7/27/18	HR/YC

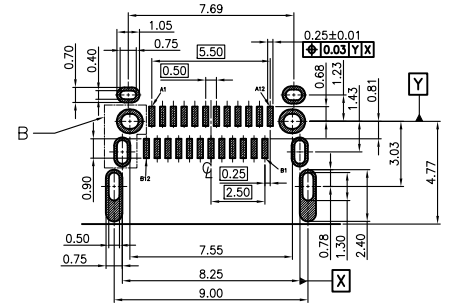

RECOMMEND P.C.B LAYOUT (COMPONENT SIDE)
 TOLERANCE FOR PCB LAYOUT IS ±0.05
 PAD AREA

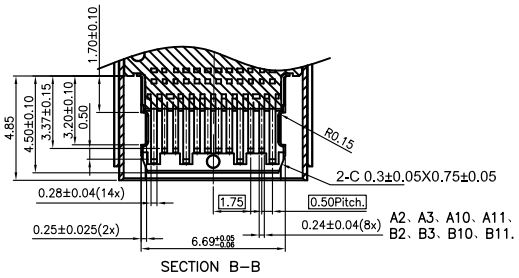
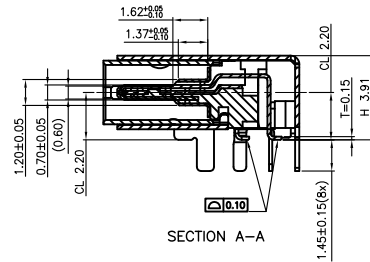
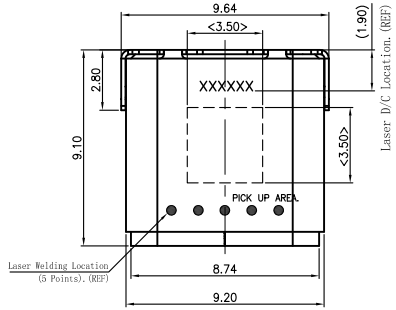
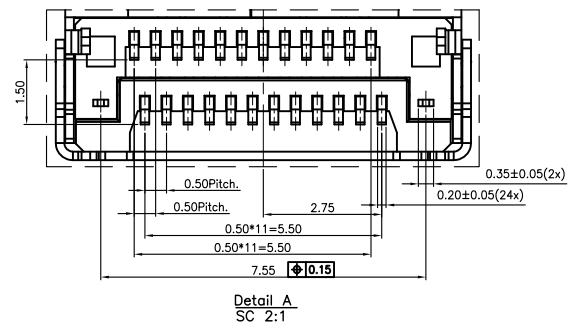
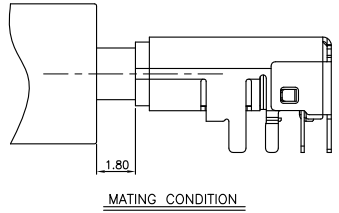
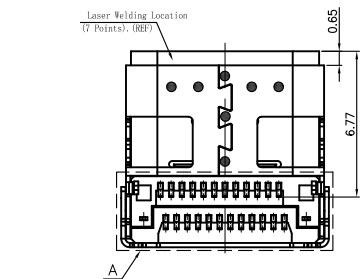
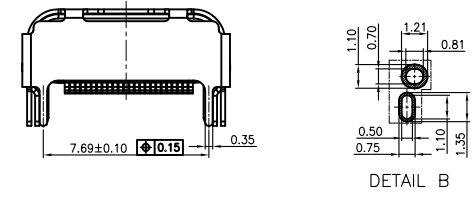
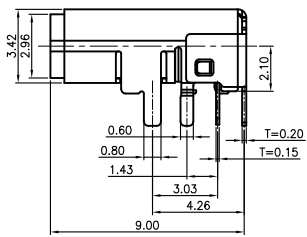
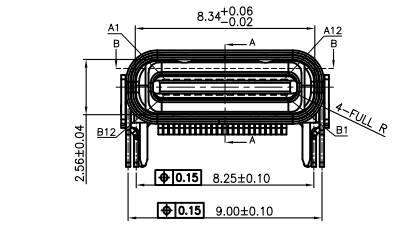

Pin	Signal Name	Mating Sequence	Pin	Signal Name	Mating Sequence
A1	GND	First	B12	GND	First
A2	SSTxp1	Second	B11	SSRxp1	Second
A3	SSTxn1	Second	B10	SSRxn1	Second
A4	V _{bus}	First	B9	V _{bus}	First
A5	CC1	Second	B8	SBU2	Second
A6	Dp1	Second	B7	Dn2	Second
A7	Dn1	Second	B6	Dp2	Second
A8	SBU1	Second	B5	CC2	Second
A9	V _{bus}	First	B4	V _{bus}	First
A10	SSRxn2	Second	B3	SSTxn2	Second
A11	SSRxp2	Second	B2	SSTxp2	Second
A12	GND	First	B1	GND	First
SHELL	GND		SHELL	GND	

SPECIFICATIONS:
 Material:
 Insulator: Hi-temp thermoplastic, rated UL 94V-0
 Insulator color: Black
 Contacts: Copper Alloy
 Shell: Stainless Steel, Nickel plated
 Plating:
 Gold flash over Nickel underplate on Contact area
 Matte Tin over Nickel underplate on Solder tails
 Electrical:
 Current rating: 5 A (Power supply pin: A1, A4, A9, A12, B1, B4, B9, B12)
 1.25 A (Vconn pin)
 0.25 A (Other signal pin)
 Contact resistance: 40 mohms max @ 20mV, 100 mA
 Insulation resistance: 100 Mohms min.
 Dielectric withstanding: 100 VAC RMS
 Mechanical:
 Insertion force: 5~20N
 Withdrawal force: 6~20N After test
 Durability: 10,000 Cycles
 Temperature Rating:
 Operating temperature: -40°C to +85°C
 Environmental:
 Lead free, RoHS compliant.



PACKAGED ON TAPE & REEL

UNLESS OTHERWISE SPECIFIED ALL DIMENSIONS ARE MILLIMETERS TOLERANCES: EXCEPT AS NOTED	
MM	ANGEL
X. ± 0.50	± 2°
X.X ± 0.25	
X.XX ± 0.20	
X.XXX ± 0.10	
APPROVALS	
DRAWN	DATE
CHECKED	3/22/18
APPROVED	AC

ADAM TECH INTERCONNECTS 909 Rahway Avenue, Union, NJ 07083
 Phone: 908-687-5000 Fax: 908-687-5710

TITLE: UNIVERSAL SERIAL BUS, TYPE C, FEMALE, RIGHT ANGLE, BLACK, TAPE & REEL

SIZE	PART NO.	REV.
X	USB-C31-S-RA-CS2-SMT-BK-T/R	A

REF: S00296T SCALE: NTS SHEET 1 OF 1