

# UWB 5900-8300 MHz EMBEDDED CHIP ANTENNA

Part Numbers: 2108851-1

## FEATURES & BENEFITS

- UWB 5900-8300 MHz , Channel 5-9
- Embedded Ceramic Chip Antenna
- SMD assembly
- Available in tape & reel
- The following data is based on 20 x 24 mm ground size

## SPECIFICATIONS

Frequency Range (MHz)	5900-8300
VSWR	< 2.1:1
Average Efficiency	74%
Peak Gain	4.1 dBi
Average Gain	-1.3dBi
Feed Point Impedance	50 ohms
Polarization	Linear
Size	4.0 mm x 2.0 mm x 1.2 mm
Weight	< 0.04 g
Mounting	SMD
Mating Connector	N/A
Cable	N/A
Operating Temperature	-40 to +85°C
Storage Temperature	-40 to +85°C
Hazardous Materials	A certificate of conformance is available from the product page on TE website.

## RF DATA

### VSWR

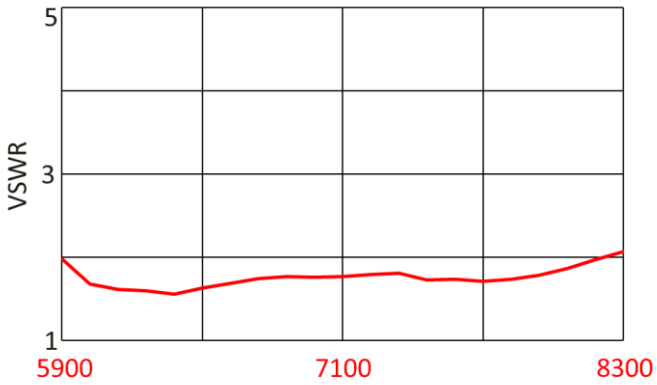

### Return Loss

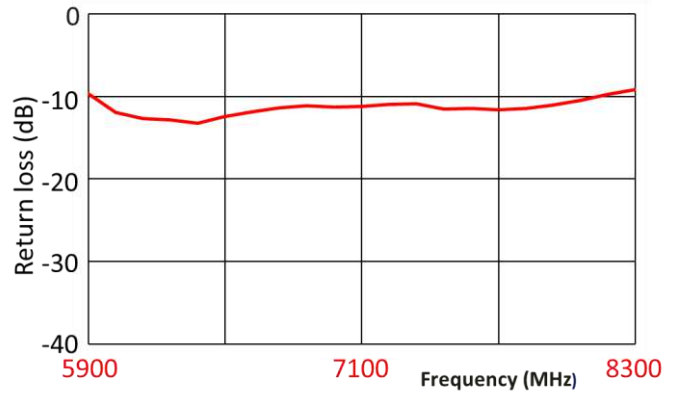

### Efficiency

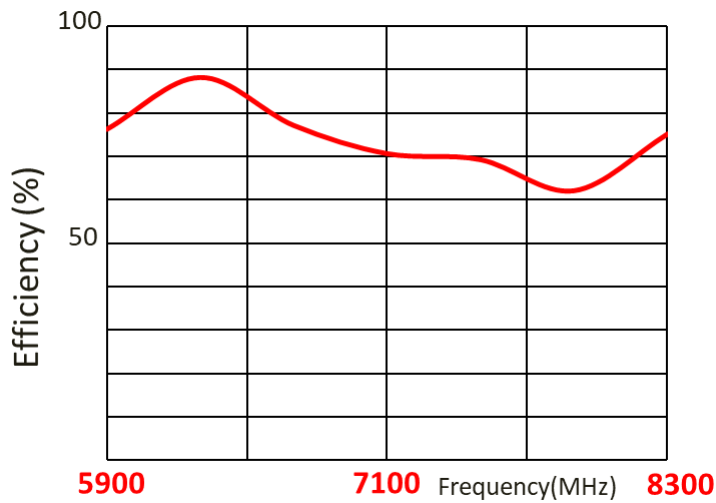

# RADIATION PATTERN

Test setup

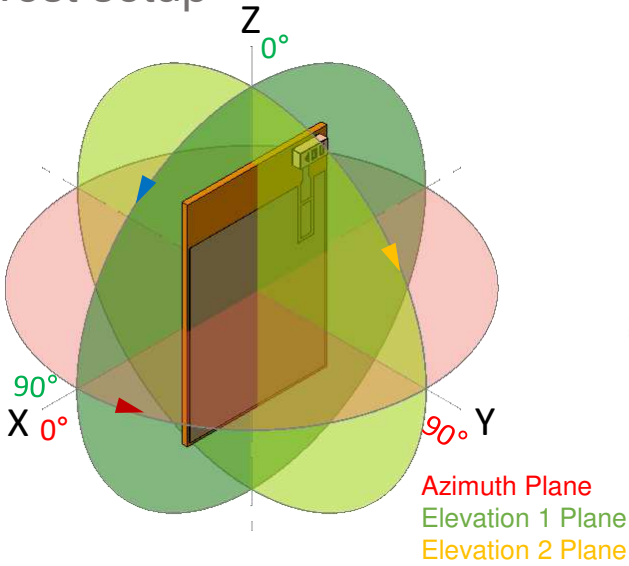

Azimuth

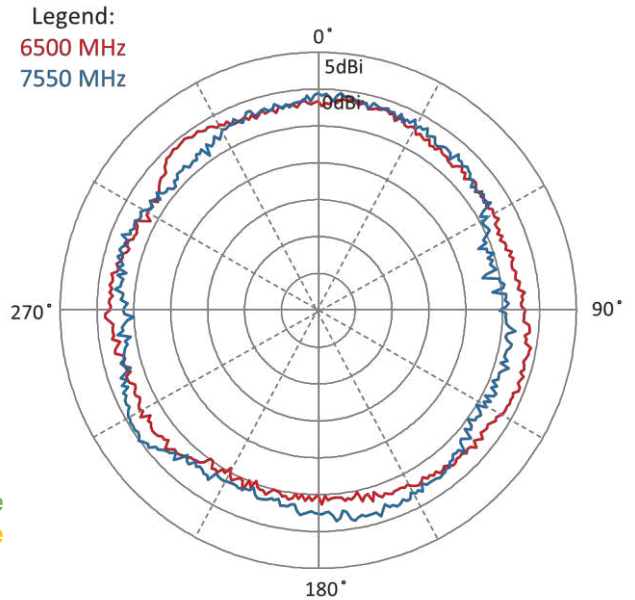

Elevation 1

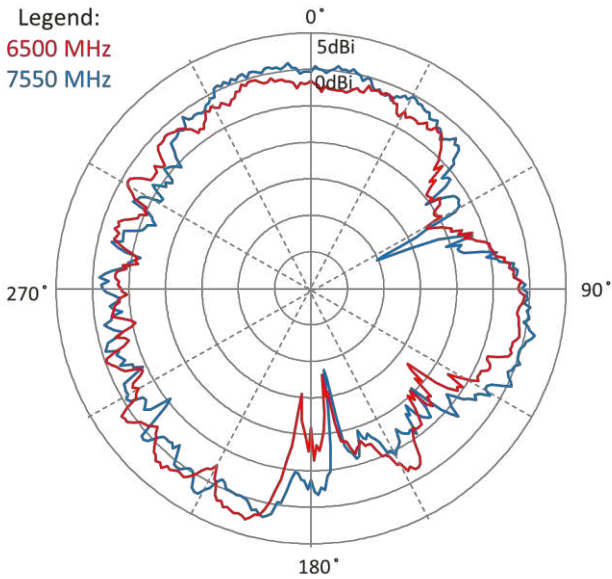

Elevation 2

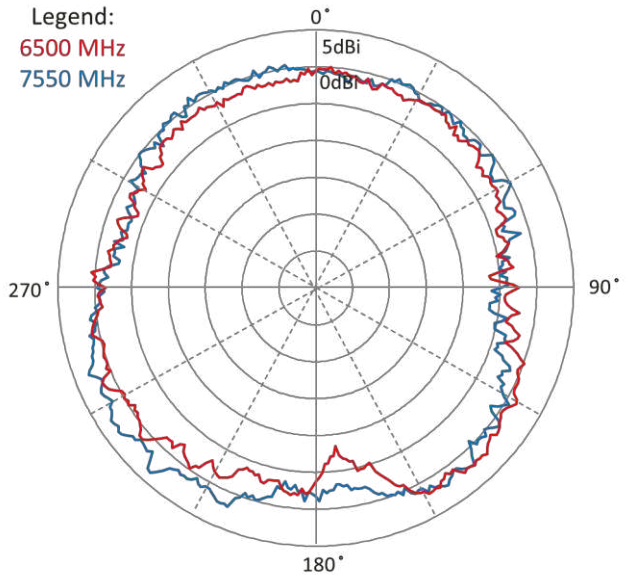

# MOUNTING GUIDE

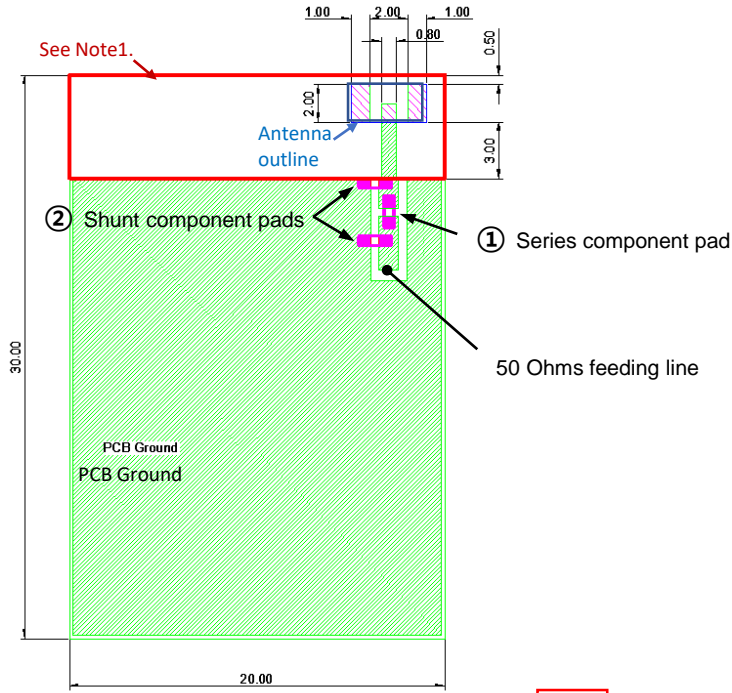

- NOTES: 1. No copper allowed in designated area on all PCB layers –   
 2. Measured with above matching circuit condition.  
 3. For more information please call TE.  
 4. Measured with below matching circuit condition.  
 ① 100pF    ② NC

Dimensions: mm  
 Diagram is not to scale

## KEEP OUT AREA

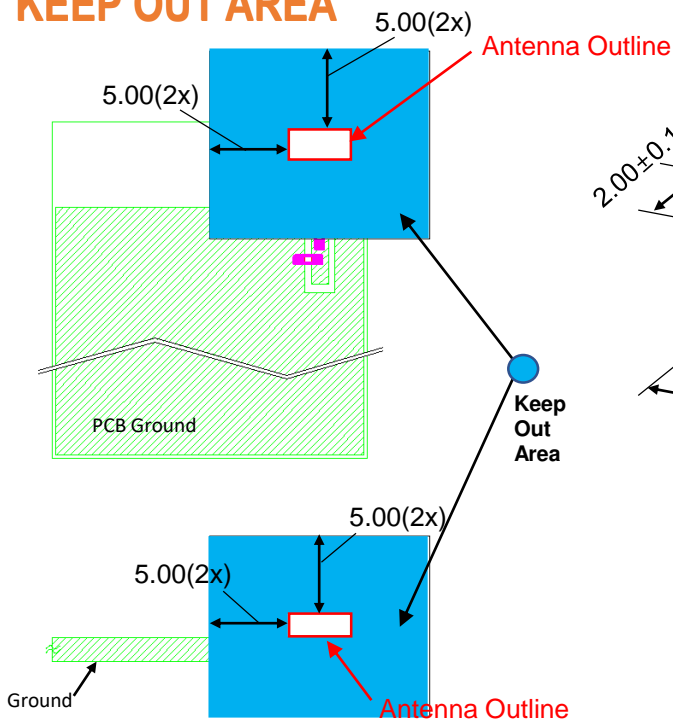

## DIMENSIONS

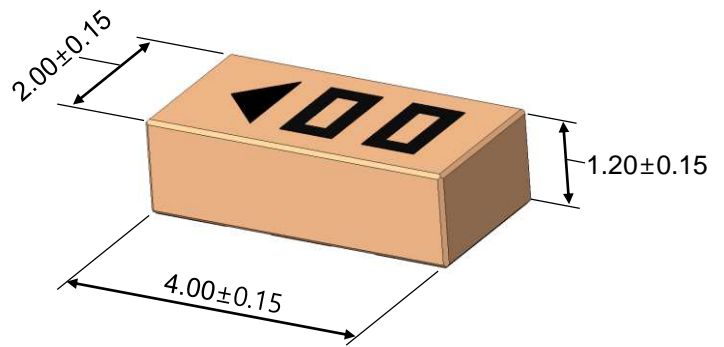

Dimensions: mm  
 Diagram is not to scale

# 6000-8100 MHz UWB EMBEDDED CHIP ANTENNA

Standard Antenna Solutions

## PACKAGING

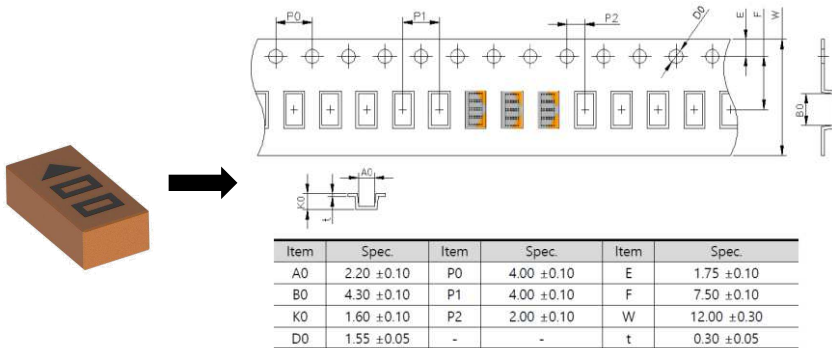

2,000pcs/1Reel  
Ø7" x 16 mm

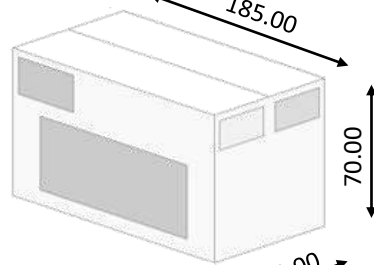

6,000pcs/3 Reel  
3 Reel/1 Inner box

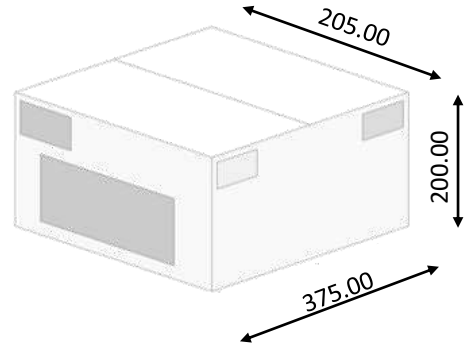

30,000pcs/5 Inner box  
5 Inner box/1 Outer box #1

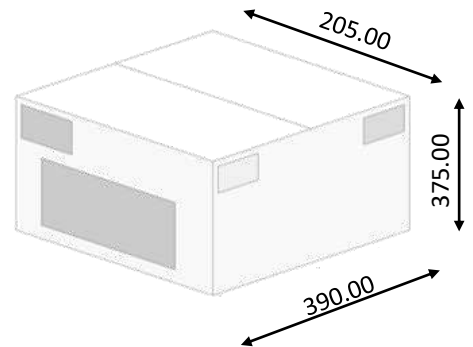

60,000pcs/10 Inner box  
10 Inner box/1 Outer box #2

### TE TECHNICAL SUPPORT CENTER

- USA: +1 (800) 522-6752
- Canada: +1 (905) 475-6222
- Mexico: +52 (0) 55-1106-0800
- Latin/S. America: +54 (0) 11-4733-2200
- Germany: +49 (0) 6251-133-1999
- UK: +44 (0) 800-267666
- France: +33 (0) 1-3420-8686
- Netherlands: +31 (0) 73-6246-999
- China: +86 (0) 400-820-6015

For phone numbers in other countries, go to [te.com/support-center](http://te.com/support-center)

### te.com

TE Connectivity, TE Connectivity (logo) are trademarks. All other logos, products and/or company names referred to herein might be trademarks of their respective owners.

The information given herein, including drawings, illustrations and schematics which are intended for illustration purposes only, is believed to be reliable. However, TE Connectivity makes no warranties as to its accuracy or completeness and disclaims any liability in connection with its use. TE Connectivity's obligations shall only be as set forth in TE Connectivity's Standard Terms and Conditions of Sale for this product and in no case will TE Connectivity be liable for any incidental, indirect or consequential damages arising out of the sale, resale, use or misuse of the product. Users of TE Connectivity products should make their own evaluation to determine the suitability of each such product for the specific application.

© 2020 TE Connectivity Ltd. family of companies All Rights Reserved.

03/2023

