

# CUBE mXTEND™: A STANDARD ANTENNA SOLUTION FOR MOBILE FREQUENCY BANDS

## CUBE mXTEND<sup>™</sup>: A STANDARD ANTENNA SOLUTION FOR MOBILE FREQUENCY BANDS

Ignion specializes in enabling effective mobile communications. Using Ignion technology, we design and manufacture optimized antennas to make your wireless devices more competitive. Our mission is to help our clients develop innovative products and accelerate their time to market through our expertise in antenna design, testing and manufacturing.

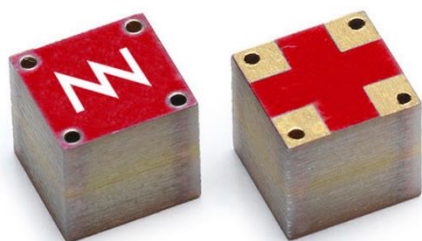

CUBE mXTEND<sup>™</sup> antenna booster

NN02-250

Ignion products are protected by [Ignion patents](#).

All information contained within this document is property of Ignion and is subject to change without prior notice. Information is provided “as is” and without warranties. It is prohibited to copy or reproduce this information without prior approval.

Ignion is an ISO 9001:2015 certified company. All our antennas are lead-free and RoHS compliant.

ISO 9001: 2015 Certified



## TABLE OF CONTENTS

<b>1. ANTENNA DESCRIPTION</b>	<b>4</b>
<b>2. QUICK REFERENCE GUIDE</b>	<b>5</b>
<b>3. ELECTRICAL PERFORMANCE</b>	<b>5</b>
<b>3.1. EVALUATION BOARD</b>	<b>5</b>
<b>3.2. MATCHING NETWORK</b>	<b>6</b>
<b>3.3. VSWR AND TOTAL EFFICIENCY</b>	<b>7</b>
<b>3.4. RADIATION PATTERNS (824-960 MHz), GAIN AND EFFICIENCY</b>	<b>8</b>
<b>3.5. RADIATION PATTERNS (1710-2170 MHz), GAIN AND EFFICIENCY</b>	<b>9</b>
<b>3.6. CAPABILITIES AND MEASUREMENT SYSTEMS</b>	<b>10</b>
<b>4. MECHANICAL CHARACTERISTICS</b>	<b>11</b>
<b>4.1. DIMENSIONS AND TOLERANCES</b>	<b>11</b>
<b>4.2. SPECIFICATIONS FOR THE INK</b>	<b>11</b>
<b>4.3. ANTENNA FOOTPRINT</b>	<b>12</b>
<b>5. ASSEMBLY PROCESS</b>	<b>13</b>
<b>6. PACKAGING</b>	<b>15</b>
<b>7. PRODUCT CHANGE NOTIFICATION</b>	<b>16</b>

# 1. ANTENNA DESCRIPTION

The CUBE mXTEND<sup>™</sup> antenna booster has been specifically designed for providing multiband performance in wireless devices (in particular in mobile devices), enabling worldwide coverage by allowing operation in the communication standards GSM850, GSM900, GSM1800/DCS, GSM1900/PCS, UMTS, LTE850, LTE900, LTE1700, LTE1800, LTE1900, LTE2000, and LTE2100.



**Material:** The CUBE mXTEND<sup>™</sup> antenna booster is built on glass epoxy substrate.

## APPLICATIONS

- Handsets
- Smartphones
- Tablets
- Phablets
- Laptop PCs
- Netbooks
- Modules
- Routers
- eBook readers

## BENEFITS

- High efficiency
- Small size
- Cost-effective
- Easy-to-use (pick and place)
- Multiband behaviour (worldwide standards)
- Off-the-Shelf standard product (no customization is required)

The CUBE mXTEND<sup>™</sup> antenna booster belongs to a new generation of antenna solutions based on the Virtual Antenna<sup>™</sup> technology owned by Ignion. The technology is mainly focused on replacing conventional antenna solutions by miniature and standard components.

## 2. QUICK REFERENCE GUIDE

Technical features	824 – 960 MHz	1710 – 2170 MHz
Average Efficiency	> 50 %	> 70 %
Peak Gain	0.7 dBi	2.0 dBi
VSWR	< 3:1	
Radiation Pattern	Omnidirectional	
Polarization	Linear	
Weight (approx.)	0.25 g	
Temperature	-40 to +125 °C	
Impedance	50 Ω	
Dimensions (L x W x H)	5.0 mm x 5.0 mm x 5.0 mm	

**Table 1** – Technical Features. Measures from the Evaluation board. See Figure 1. Note that for obtaining comparable results, a ground plane length larger than 100 mm is recommended.

## 3. ELECTRICAL PERFORMANCE

### 3.1. EVALUATION BOARD

This Evaluation Board integrates a UFL cable to connect the CUBE mXTEND™ antenna booster with the SMA connector. The CUBE mXTEND™ provides operation in two frequency regions, from 824 MHz to 960 MHz and from 1710 MHz to 2170 MHz, through a single input/output port.



Measure	mm
A	131.0
B	120.0
C	60.0
D	6.0
E	5.0
F	11.0

**Tolerance:** ±0.2 mm

**D:** Distance between the CUBE mXTEND™ antenna booster and the ground plane.

**E:** Distance between the CUBE mXTEND™ antenna booster and the corner of the evaluation board.

**Material:** The Evaluation Board is built on FR4 substrate. Thickness is 1 mm.

**Clearance Area:** 60 mm x 11 mm (Cx F)

**Figure 1** – EB\_NN02-250-1B-2R-1P. Evaluation Board providing operation from 824 MHz to 960 MHz and 1710 MHz to 2170MHz.

This product is protected by at least the following [patents](#) PAT. US 8,203,492, PAT. US 8,237,615 and other domestic and international patents pending. Any update on new patents linked to this product will appear in [www.ignion.io/virtual-antenna/](http://www.ignion.io/virtual-antenna/).

### 3.2. MATCHING NETWORK

The specs of a Ignion standard product are measured in their Evaluation Board, which is an ideal case. In a real design, components nearby the antenna, LCD's, batteries, covers, connectors, etc. affect the antenna performance. This is the reason why it is highly recommended placing pads compatible with 0402 and 0603 SMD components for a matching network as close as possible to the feeding point. Do it in the ground plane area, not in the clearance area. This provides a degree of freedom to tune the CUBE mXTEND™ antenna booster once the design is finished and considering all elements of the system (batteries, displays, covers, etc.).

Please notice that different devices with different ground planes and different components nearby the CUBE mXTEND™ antenna booster may need a different matching network. To ensure optimal results, the use of high Q and tight tolerance components is highly recommended (Murata components). If you need assistance to design your matching network beyond this application note, please contact [support@ignion.io](mailto:support@ignion.io), or try our free-of-charge<sup>1</sup> **NN Wireless Fast-Track** design service, you will get your chip antenna design including a custom matching network for your device in 24h<sup>1</sup>. Other related to NN's range of R&D services is available at: <https://www.ignion.io/rdservices/>

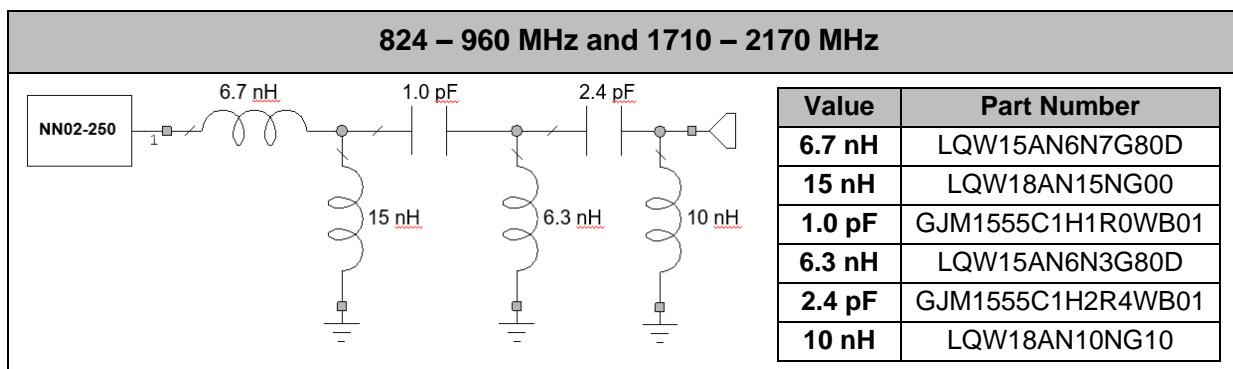
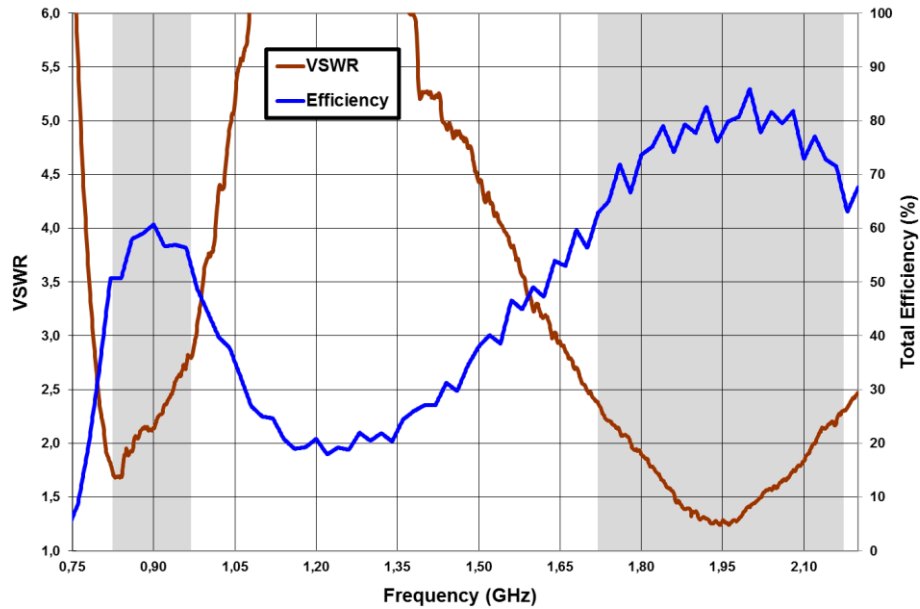

**Figure 2** – Matching Network implemented in the evaluation board (Figure 1).

<sup>1</sup> See terms and conditions for a free NN Wireless Fast-Track service in 24h at: <https://www.ignion.io/fast-track-project/>

### 3.3. VSWR AND TOTAL EFFICIENCY

VSWR (Voltage Standing Wave Ratio) and Total Efficiency versus Frequency (GHz).



**Figure 3** – VSWR and Total Efficiency for the 824 – 960 MHz frequency range and for the 1710 – 2170 MHz frequency range (from the evaluation board (Figure 1)).

### 3.4. RADIATION PATTERNS (824-960 MHz), GAIN AND EFFICIENCY

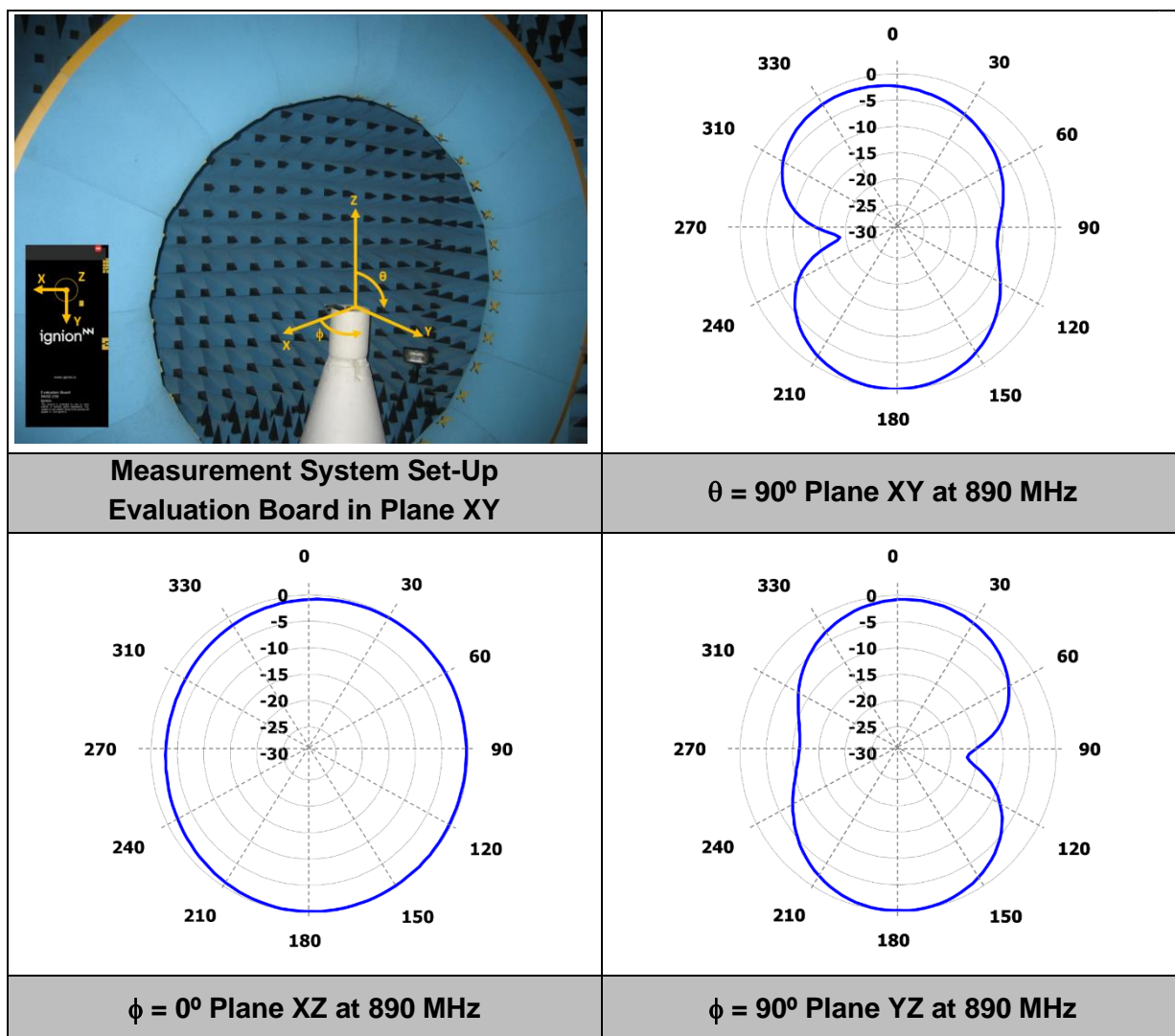

<b>Gain</b>	<b>Peak Gain</b>	0.7 dBi
	<b>Average Gain across the band</b>	0.4 dBi
	<b>Gain Range across the band (min, max)</b>	-0.2 $\leftrightarrow$ 0.7 dBi
<b>Efficiency</b>	<b>Peak Efficiency</b>	60.7 %
	<b>Average Efficiency across the band</b>	56.7 %
	<b>Efficiency Range across the band (min, max)</b>	50.7 – 60.7 %

**Table 2** – Antenna Gain and Total Efficiency from the evaluation board (Figure 1) within the 824 – 960 MHz frequency range. Measures made in the Satimo STARGATE 32 anechoic chamber.



### 3.5. RADIATION PATTERNS (1710-2170 MHz), GAIN AND EFFICIENCY

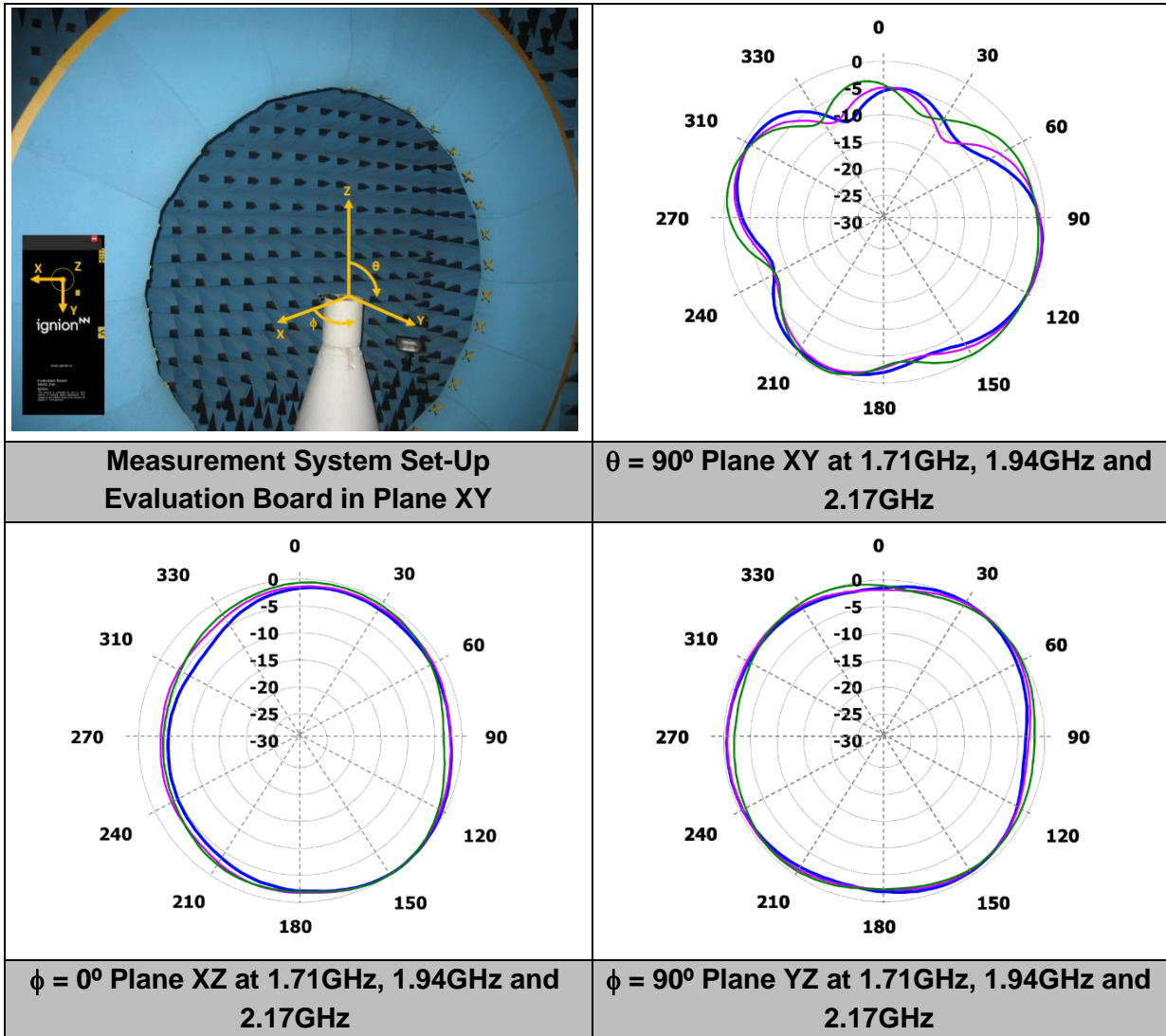

Gain	Peak Gain	2.0 dBi
	Average Gain across the band	1.5 dBi
	Gain Range across the band (min, max)	0.7 ↔ 2.0 dBi
Efficiency	Peak Efficiency	85.9 %
	Average Efficiency across the band	75.8 %
	Efficiency Range across the band (min, max)	59.5 – 85.9 %

**Table 3** – Antenna Gain and Total Efficiency from the evaluation board (Figure 1) within the 1710 – 2170 MHz frequency range. Measures made in the Satimo STARGATE 32 anechoic chamber.

### 3.6. CAPABILITIES AND MEASUREMENT SYSTEMS

Ignion specializes in designing and manufacturing optimized antennas for wireless applications and providing our clients with RF expertise. We offer turn-key antenna products and antenna integration support to minimize your time requirement and maximize your return on investment during your product development efforts. We also provide our clients with the opportunity to leverage our in-house testing and measurement facilities to obtain accurate results quickly and efficiently.

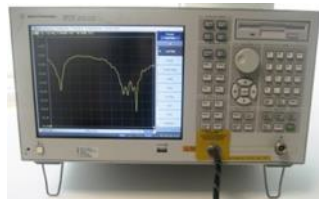

Agilent E5071B

VSWR  
&  
S Parameters

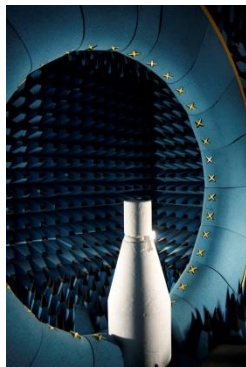
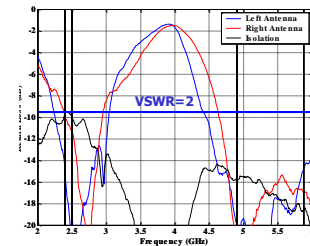

SATIMO STARGATE 32

Radiation  
Pattern  
&  
Efficiency

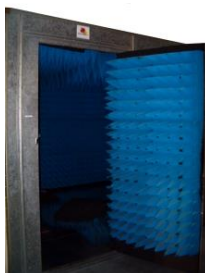
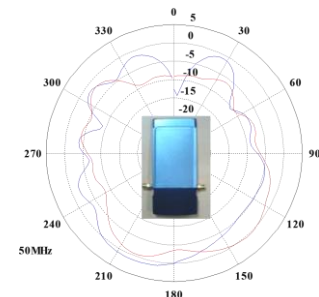

Anechoic chambers and full equipped in-house lab

## 4. MECHANICAL CHARACTERISTICS

### 4.1. DIMENSIONS AND TOLERANCES

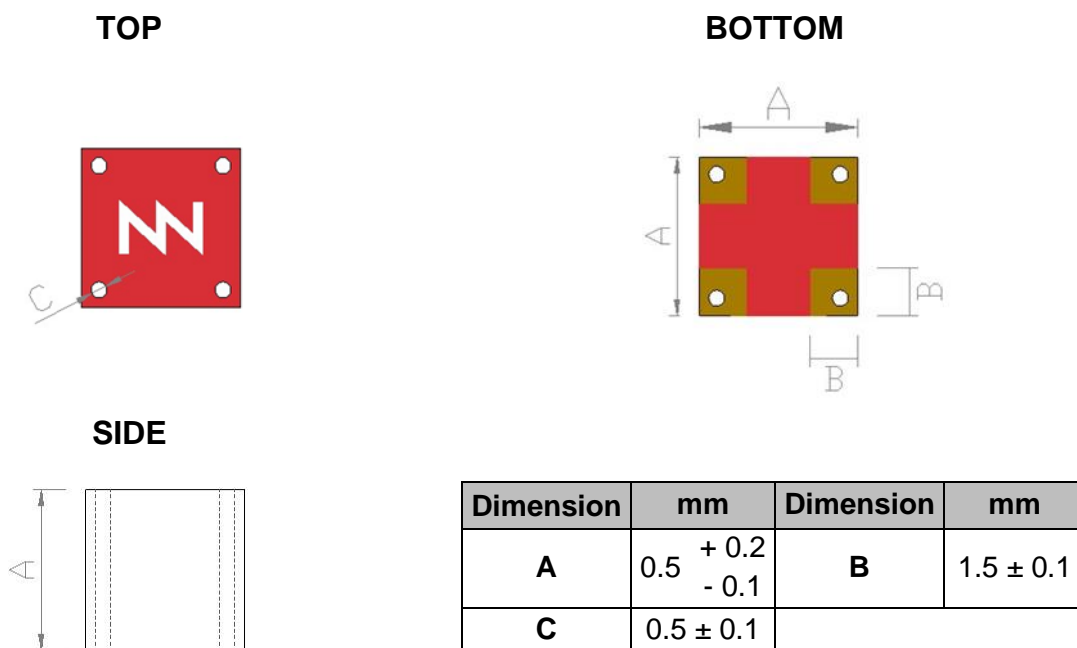

Figure 4 – CUBE mXTEND™ antenna booster dimensions and tolerances.

The 4 pads are fully symmetrical to mount it on the PCB.

The CUBE mXTEND™ antenna booster NN02-250 is compliant with the restriction of the use of hazardous substances (**RoHS**). The RoHS certificate can be downloaded from [www.ignion.io](http://www.ignion.io).

### 4.2. SPECIFICATIONS FOR THE INK

Next figure shows the range of the colors in the CUBE mXTEND™ antenna booster:

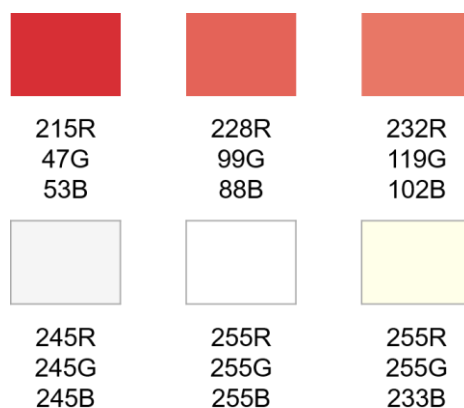

Acceptable color range

### 4.3. ANTENNA FOOTPRINT

Assuming that the CUBE mXTEND<sup>™</sup> antenna booster NN02-250 is placed in the clearance area of the PCB, see below the recommended footprint dimensions.

Measure	mm
<b>A</b>	1.7
<b>B</b>	1.6
<b>C</b>	2.0

**Tolerance:**  $\pm 0.1$   
mm

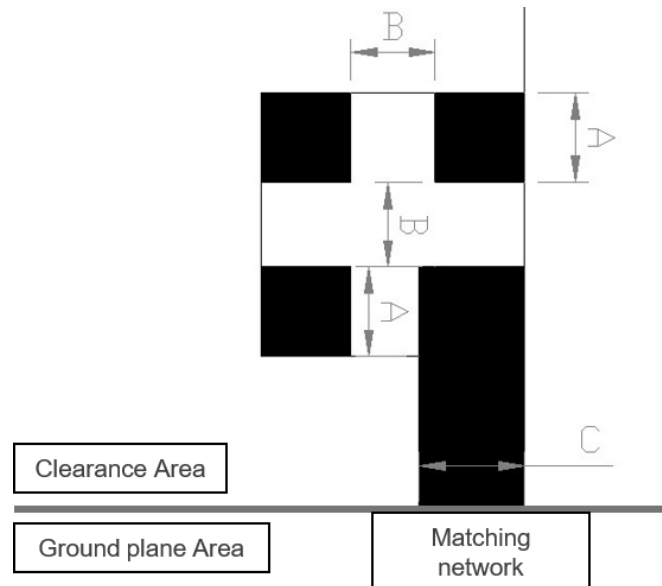

**Figure 5** – Footprint dimensions for the single booster.

For additional support in the integration process, please contact [support@ignion.io](mailto:support@ignion.io).

## 5. ASSEMBLY PROCESS

Figure 6 shows the back and front view of the CUBE mXTEND<sup>™</sup> antenna booster NN02-250. Due to the symmetry in the product configuration, the feeding pad can be any of the 4 pads.

**Mounting Pads (2, 3, 4):** solder the CUBE mXTEND<sup>™</sup> antenna booster mounting pads to the soldering pads on the PCB. These pads must NOT be grounded.

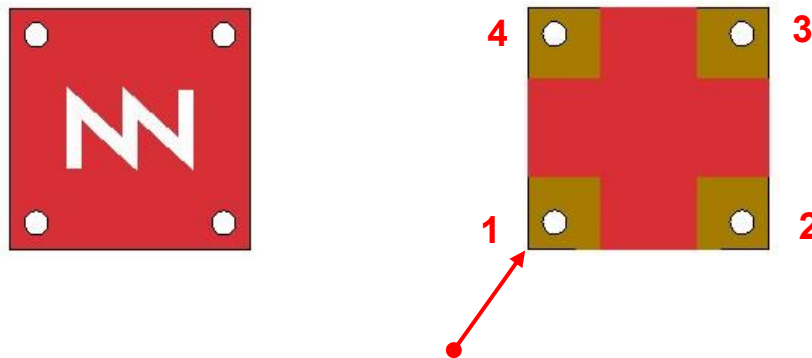

**Feed Pad (1):** The 4 pads are fully symmetrical. Once the feeding pad is selected (1), the other 3 pads become mounting pads. Align the feed pad with the feeding line on the PCB. See section 0.

**Figure 6** – Pads of the CUBE mXTEND<sup>™</sup> antenna booster NN02-250.

As a surface mount device (SMD), the CUBE mXTEND<sup>™</sup> antenna booster is compatible with industry standard soldering processes. The basic assembly procedure for the CUBE mXTEND<sup>™</sup> antenna booster is as follows:

1. Apply a solder paste on the pads of the PCB. Place the CUBE mXTEND<sup>™</sup> antenna booster on the board.
2. Perform a reflow process according to the temperature profile detailed in Table 4, Figure 8 (page 14).
3. After soldering the CUBE mXTEND<sup>™</sup> antenna booster to the circuit board, perform a cleaning process to remove any residual flux. Ignion recommends conducting a visual inspection after the cleaning process to verify that all reflux has been removed.

The drawing below shows the soldering details obtained after a correct assembly process:

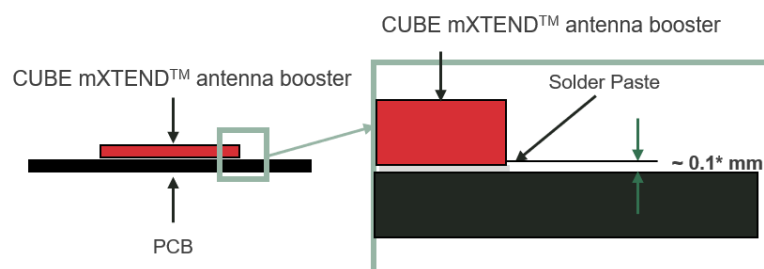

**Figure 7** – Soldering Details.

**NOTE(\*):** Solder paste thickness after the assembly process will depend on the thickness of the soldering stencil mask. A stencil thickness equal or larger than **127 microns (5 mils)** is required. The CUBE mXTEND<sup>™</sup> antenna booster NN02-250 can be assembled following the Pb-free assembly process. According to the Standard **IPC/JEDEC J-STD-020C**, the temperature profile suggested is as follows:

Phase	Profile features	Pb-Free Assembly (SnAgCu)
<b>RAMP-UP</b>	Avg. Ramp-up Rate (T <sub>smax</sub> to T <sub>p</sub> )	3 °C / second (max.)
<b>PREHEAT</b>	<ul style="list-style-type: none"> <li>- Temperature Min (T<sub>smin</sub>)</li> <li>- Temperature Max (T<sub>smax</sub>)</li> <li>- Time (t<sub>smin</sub> to t<sub>smax</sub>)</li> </ul>	150 °C 200 °C 60-180 seconds
<b>REFLOW</b>	<ul style="list-style-type: none"> <li>- Temperature (T<sub>L</sub>)</li> <li>- Total Time above T<sub>L</sub> (t<sub>L</sub>)</li> </ul>	217 °C 60-150 seconds
<b>PEAK</b>	<ul style="list-style-type: none"> <li>- Temperature (T<sub>p</sub>)</li> <li>- Time (t<sub>p</sub>)</li> </ul>	260 °C 20-40 seconds
<b>RAMP-DOWN</b>	Rate	6 °C/second max
<b>Time from 25 °C to Peak Temperature</b>		8 minutes max

**Table 4** – Recommended soldering temperatures.

Next graphic shows temperature profile (grey zone) for the CUBE mXTEND<sup>™</sup> antenna booster assembly process reflow ovens.

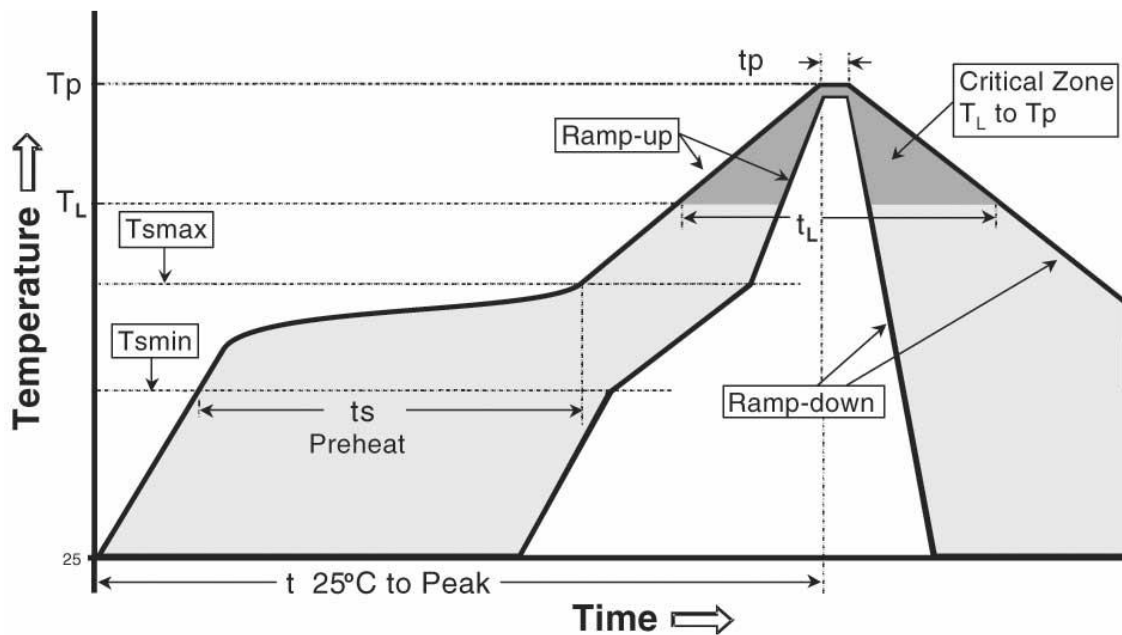

**Figure 8** – Temperature profile.

## 6. PACKAGING

The CUBE mXTEND™ antenna booster NN02-250 is delivered in tape and reel packaging.

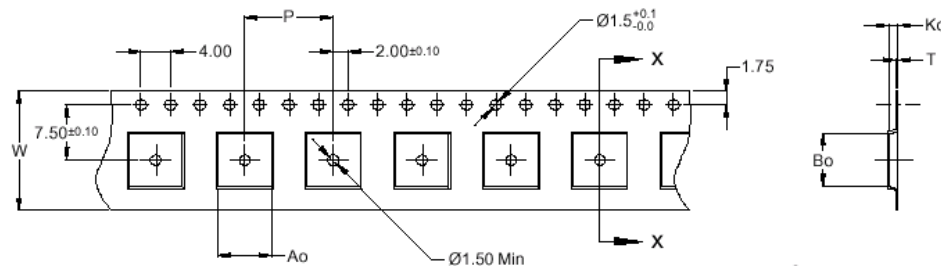

Measure	mm
A0	5.3 ± 0.1
B0	5.3 ± 0.1
K0	5.3 ± 0.1
W	16.0 ± 0.3
P	8.0 ± 0.1
T	0.4 ± 0.1

Figure 9 – Tape dimensions and Tolerances.

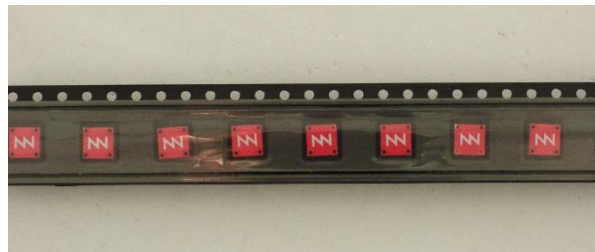
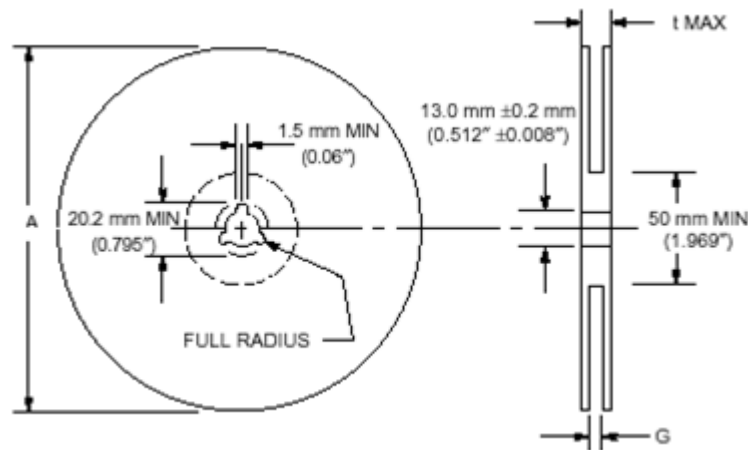

Figure 10 – Image of the tape.



Measure	mm
A	330 ± 1.0
G	17.5 ± 0.2
tMAX	21.5 ± 0.2

Reel Capacity: 1000 pcs

Figure 11 – Reel Dimensions and Capacity.

## 7. PRODUCT CHANGE NOTIFICATION

This document is property of Ignion,  
Not to disclose or copy without prior written consent

PCN Number: NN19100014

Notification Date: October 07<sup>th</sup>, 2019

### Part Number identification:

Part Number changes, it will be applied in all the document of the company (User Manual, Data Sheet, ...)

Previous Part Number
FR01-S4-250

New Part Number
NN02-250

### Reason for change:

- |  |  |
|--|--|
| <input type="checkbox"/> Specs (electrical/mechanical) | <input type="checkbox"/> Manufacturing location        |
| <input type="checkbox"/> User Manual/Data Sheet        | <input type="checkbox"/> Quality/Reliability           |
| <input type="checkbox"/> Material/Composition          | <input type="checkbox"/> Logistics                     |
| <input type="checkbox"/> Processing/Manufacturing      | <input checked="" type="checkbox"/> Other: Part Number |

### Change description

- 1.- Part Number: From FR01-S4-250 FRACTUS to NN02-250 Ignion in the User Manual

### Comments:

- 1.- Electrical and Mechanical specs remain the same
- 2.- Footprint in the PCB to solder the chip antenna remains the same

### Identification method

- 1.- The part number on the documentation of the antenna is different, the antenna layout remains the same

User Manual	<input checked="" type="checkbox"/>	Available from: May 2020
Samples	<input checked="" type="checkbox"/>	Available from: March 2020

### Ignion Contact:

Sales		Supply Chain	
Name:	Josep Portabella	Name:	Albert Vidal
Email:	<a href="mailto:josep.portabella@ignion.io">josep.portabella@ignion.io</a>	Email:	<a href="mailto:albert.vidal@ignion.io">albert.vidal@ignion.io</a>





Your innovation.  
Accelerated.

## Contact:

[support@ignion.io](mailto:support@ignion.io)

+34 935 660 710

### Barcelona

Av. Alcalde Barnils, 64-68 Modul C, 3a pl.  
Sant Cugat del Vallés  
08174 Barcelona  
Spain

### Shanghai

Shanghai Bund Centre  
18/F Bund Centre, 222 Yan'an Road East,  
Huangpu District  
Shanghai, 200002  
China

### New Delhi

New Delhi, Red Fort Capital Parsvnath Towers  
Bhai Veer Singh Marg, Gole Market,  
New Delhi, 110001  
India

### Tampa

8875 Hidden River Parkway  
Suite 300  
Tampa, FL 33637  
USA