

Active Doubler

2.5 - 6.0 / 5.0 - 12.0 GHz



XX1002-QH
Rev. V5

Features

- Octave Bandwidth Operation
- Output Power = 16 dBm
- Fundamental Leakage = -35 dBc
- Bias = 5 V, 125 mA
- 100% RF, DC and Output Power Testing
- Lead-Free 4 mm 24-lead QFN Package
- RoHS* Compliant

Applications

- Point-to-Point
- SATCOM
- VSAT

Description

The XX1002-QH is a 2.5 - 6.0 / 5.0 - 12.0 GHz QFN active doubler that delivers +16 dBm of output power. The device combines an active doubler with an output buffer amplifier that delivers constant power over a range of input powers. The device has excellent rejection of the fundamental and harmonic products and requires a single positive bias supply.

This device uses MACOM's GaAs HBT device technology to ensure high reliability and uniformity. The device comes in a low-cost 4 mm QFN surface mount plastic package offering excellent RF and thermal properties and is RoHS compliant.

This device is specifically designed for point-to-point radio applications and is well suited for other telecom applications such as SATCOM and VSAT.

Ordering Information¹

Part Number	Package
XX1002-QH-0G0T	tape and reel
XX1002-QH-EV1	evaluation module

1. Reference Application Note M513 for reel size information.

Functional Block Diagram

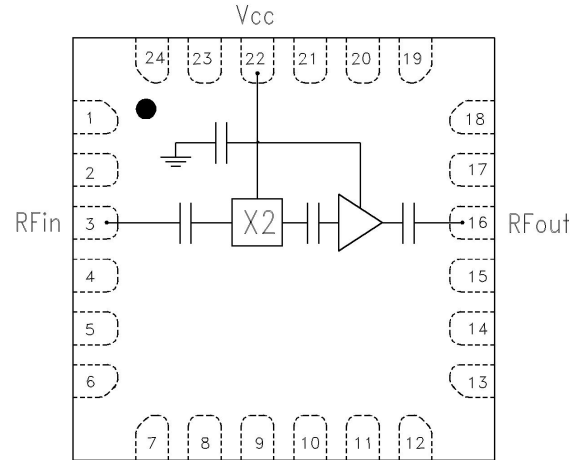

TOP VIEW

Pin Configuration²

Pin #	Function	Pin #	Function
3	RF In	22	V _{cc}
16	RF Out	25	Paddle ³

2. MACOM recommends connecting unused package pins to ground.
3. The exposed paddle centered on the package bottom must be connected to RF and DC ground.

* Restrictions on Hazardous Substances, compliant to current RoHS EU directive.

Active Doubler

2.5 - 6.0 / 5.0 - 12.0 GHz



XX1002-QH
Rev. V5

Electrical Specifications: Input Freq. = 2.5 - 6.0 GHz (unless otherwise noted), T_A = 25°C

Parameter	Units	Min.	Typ.	Max.
Output Frequency Range	GHz	5	-	12
Input Return Loss	dB	-	-15	-
Output Return Loss	dB	-	-7	-
Saturated Output Power	dBm	+13	+16	-
RF Input Power	dBm	-3	-	+3
Fundamental Leakage (Input Freq. = 2.5 - 4.25 GHz)	dBc	-	-35	-23
Third Harmonic Leakage	dBc	-	-30	-
Fourth Harmonic Leakage	dBc	-	-20	-
Bias Voltage	VDC	-	+5.0	+5.5
Supply Current (Quiescent)	mA	-	102	140

Absolute Maximum Ratings^{4,5}

Parameter	Absolute Max.
Supply Voltage	6 V
Supply Current	200 mA
Input Power	10 dBm
Junction Temperature ^{6,7}	+150°C
Operating Temperature	-55°C to +85°C
Storage Temperature	-65°C to +165°C

- Exceeding any one or combination of these limits may cause permanent damage to this device.
- MACOM does not recommend sustained operation near these survivability limits.
- Operating at nominal conditions with T_J ≤ +150°C will ensure MTTF > 1 x 10⁶ hours.
- Junction Temperature (T_J) = T_C + Θ_{JC} * (V * I)
Typical CW thermal resistance (Θ_{JC}) = 77°C/W

PCB Layout

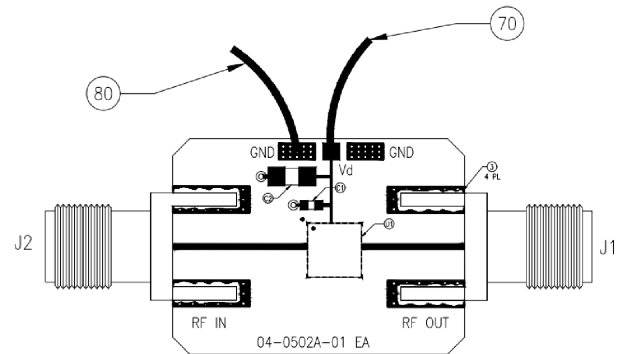

Parts List

Component	Value	Package
C1	1 nF	0402
C2	1 μF	0805

Biasing

The device is operated by biasing VCC = 5 V which will draw typically 102 mA quiescent / 125 mA under RF drive. The device requires by-passing as shown in the recommended layout with C1 = 1 nF and C2 = 1 μF.

Typical Performance Curves

(x2) Output Power

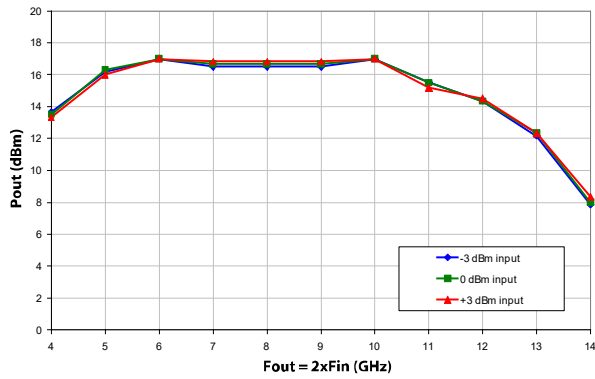

Fundamental Leakage

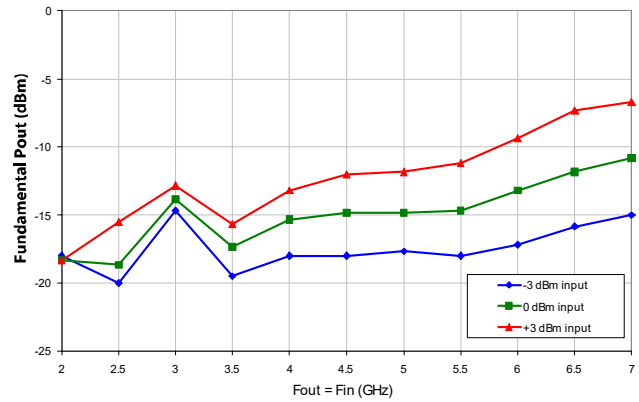

(3xFin) Harmonic Suppression

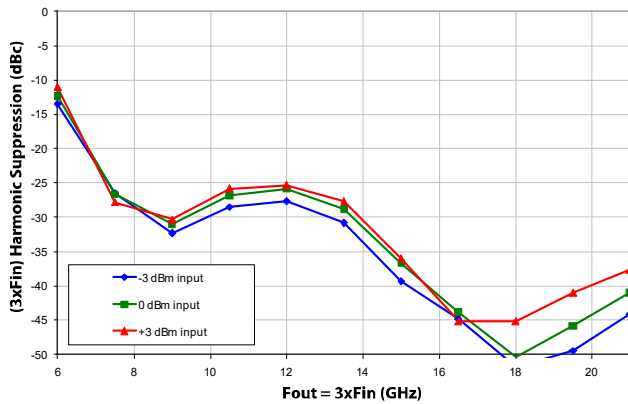

Fundamental Suppression

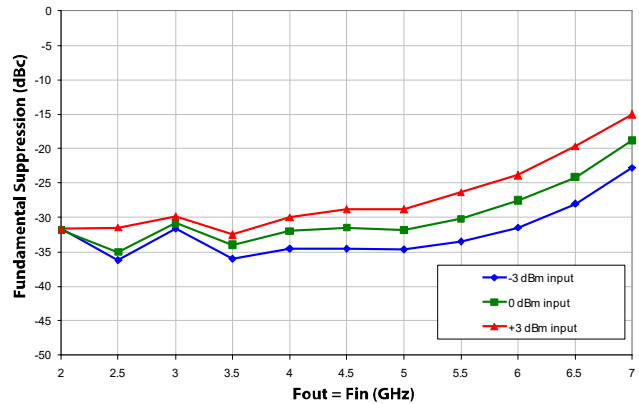

(4xFin) Harmonic Suppression

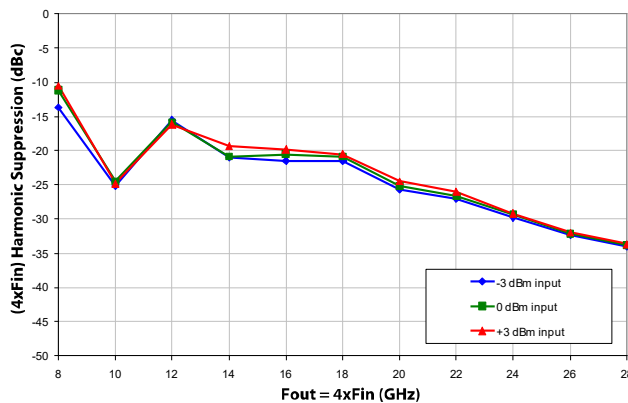

Typical Performance Curves

Input Return Loss (S11)

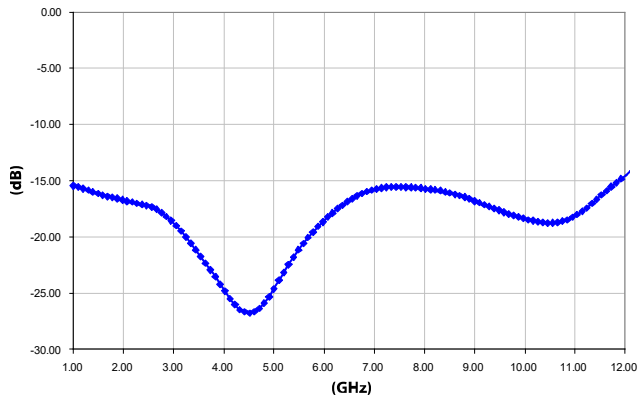

Output Return Loss (S22)

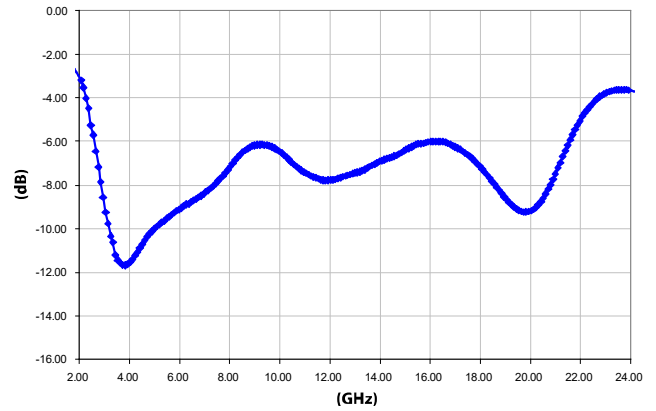

(2xFin) Output Power

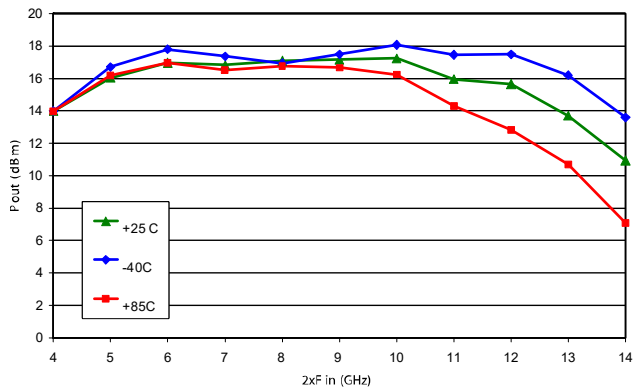

Fundamental Rejection

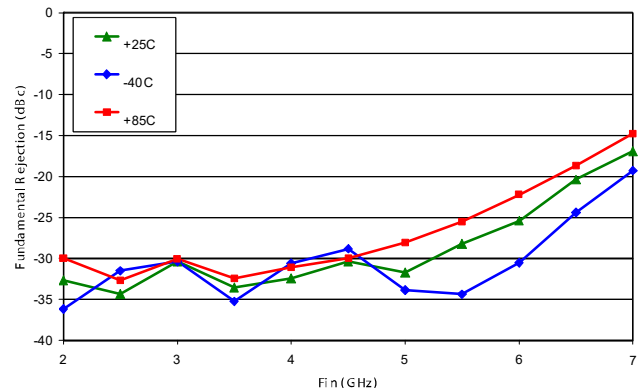

(3xFin) Rejection

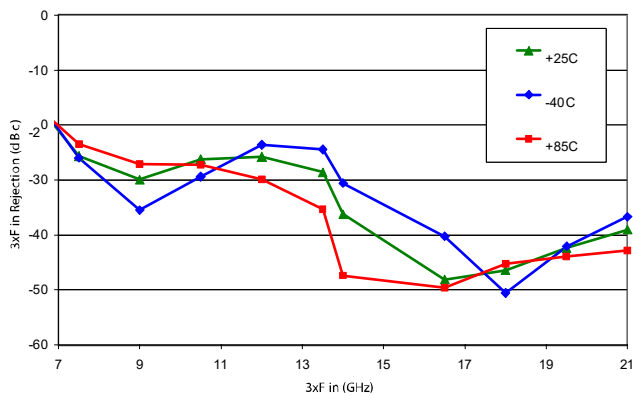

(4xFin) Rejection

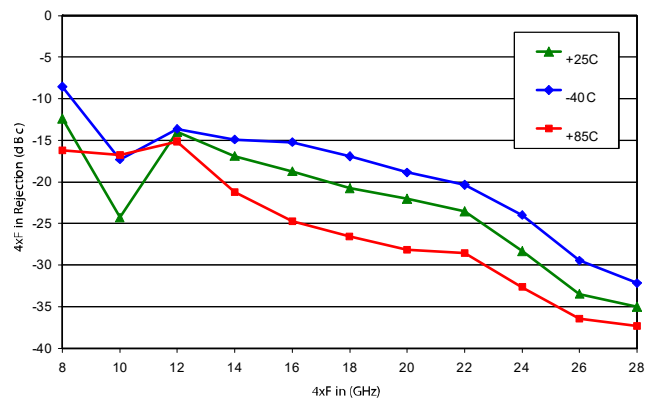

MTTF

XX1002-QH: MTTF hours vs. Package Base Temperature
Vcc=5.0V, Icc=125mA

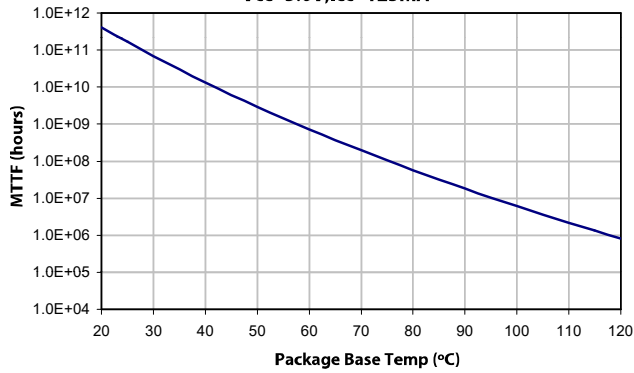

XX1002-QH: Tch (max) vs. Package Base Temperature
Vcc=5.0V, Icc=125mA

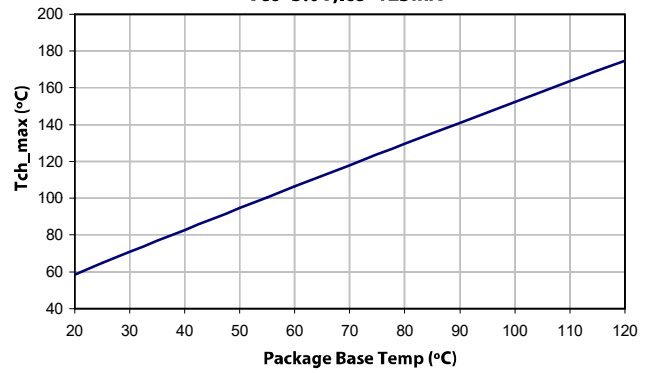

Lead-Free 4mm 24-lead PQFN†

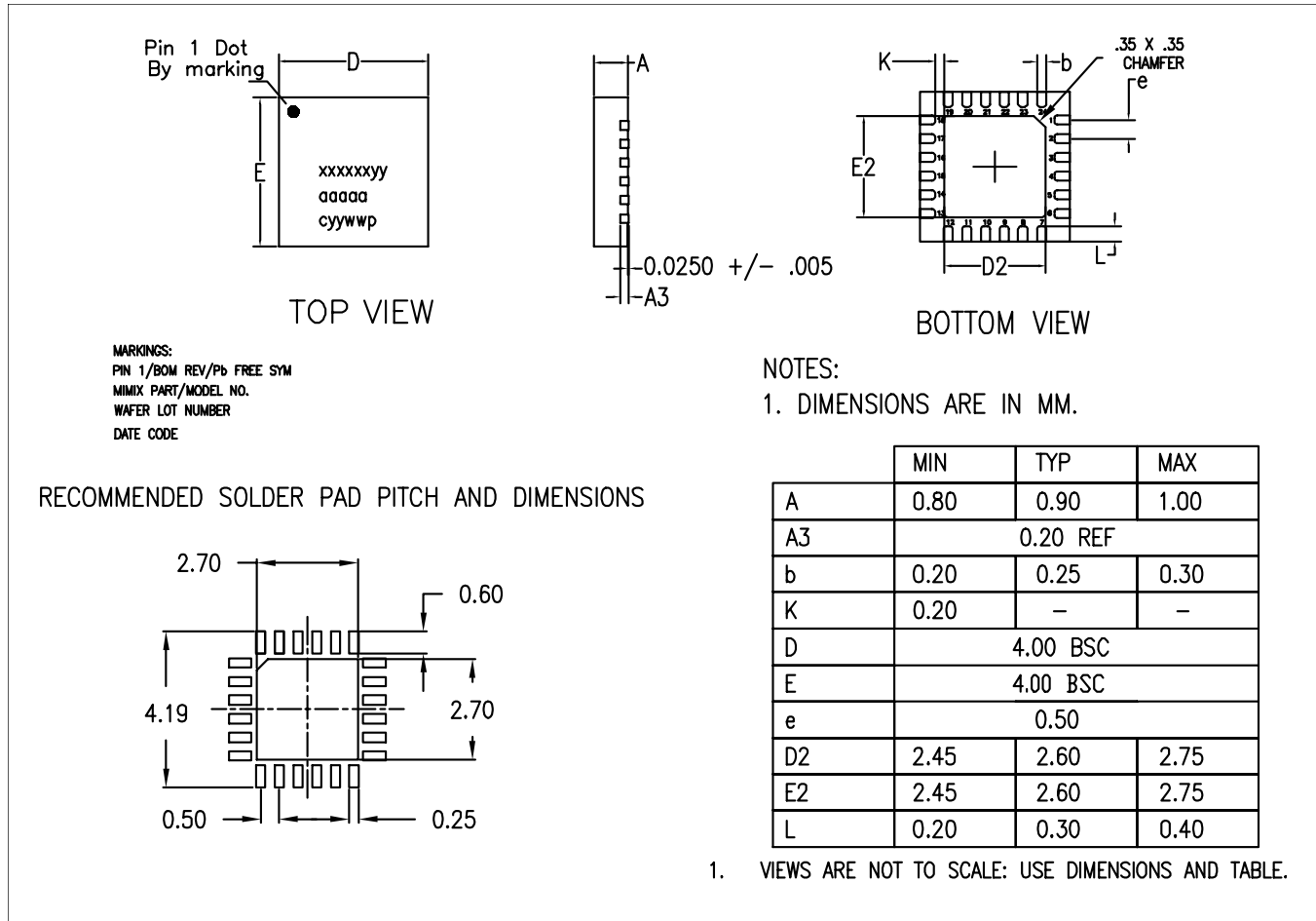

† Reference Application Note S2083 for lead-free solder reflow recommendations.
 Meets JEDEC moisture sensitivity level 1 requirements.
 Plating is 100% matte tin over copper.

Handling Procedures

Please observe the following precautions to avoid damage:

Static Sensitivity

Gallium Arsenide Integrated Circuits are sensitive to electrostatic discharge (ESD) and can be damaged by static electricity. Proper ESD control techniques should be used when handling these Class 0 (200 V HBM) devices.

Active Doubler

2.5 - 6.0 / 5.0 - 12.0 GHz



XX1002-QH

Rev. V5

MACOM Technology Solutions Inc. ("MACOM"). All rights reserved.

These materials are provided in connection with MACOM's products as a service to its customers and may be used for informational purposes only. Except as provided in its Terms and Conditions of Sale or any separate agreement, MACOM assumes no liability or responsibility whatsoever, including for (i) errors or omissions in these materials; (ii) failure to update these materials; or (iii) conflicts or incompatibilities arising from future changes to specifications and product descriptions, which MACOM may make at any time, without notice. These materials grant no license, express or implied, to any intellectual property rights.

THESE MATERIALS ARE PROVIDED "AS IS" WITH NO WARRANTY OR LIABILITY, EXPRESS OR IMPLIED, RELATING TO SALE AND/OR USE OF MACOM PRODUCTS INCLUDING FITNESS FOR A PARTICULAR PURPOSE, MERCHANTABILITY, INFRINGEMENT OF INTELLECTUAL PROPERTY RIGHT, ACCURACY OR COMPLETENESS, OR SPECIAL, INDIRECT, INCIDENTAL, OR CONSEQUENTIAL DAMAGES WHICH MAY RESULT FROM USE OF THESE MATERIALS.

MACOM products are not intended for use in medical, lifesaving or life sustaining applications. MACOM customers using or selling MACOM products for use in such applications do so at their own risk and agree to fully indemnify MACOM for any damages resulting from such improper use or sale.