

REVISIONS				
ZONE	REV	DESCRIPTION	DATE	APPROVED

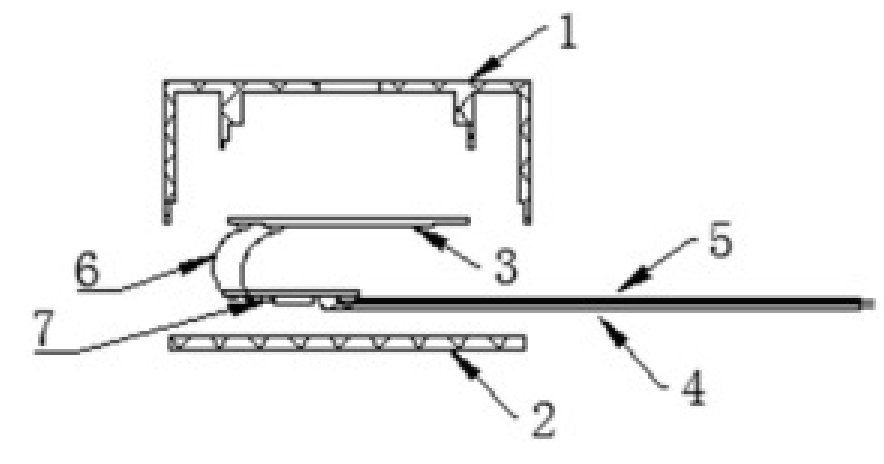

no	item	material
1	Case	PPO
2	Cover	PPO
3	Piezo	Brass + Ceramics
4	Wire	UL1007 26#
5	Wire	UL1007 26#
6	Wire	Copper
7	PCB	Epoxy

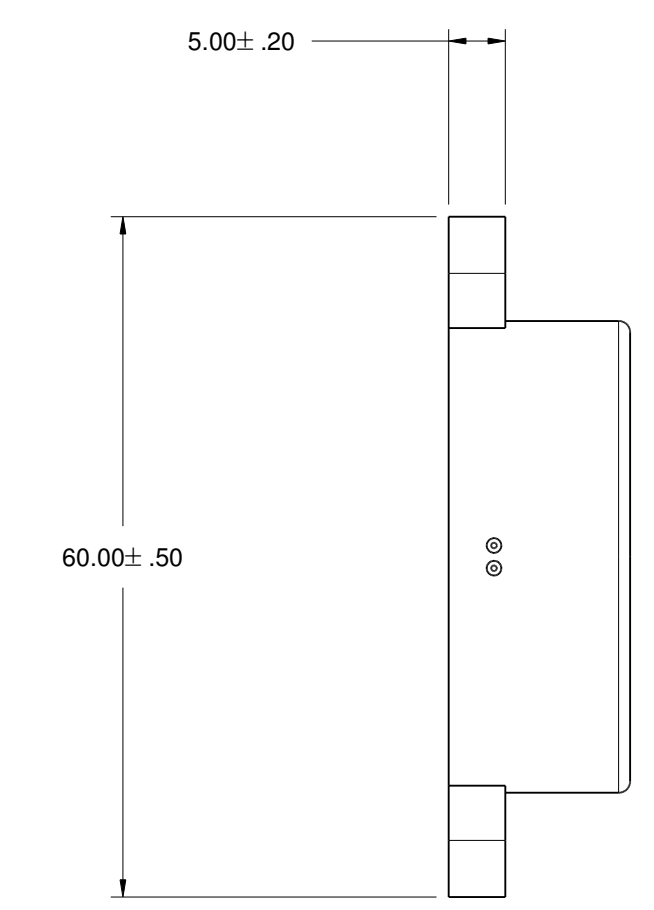
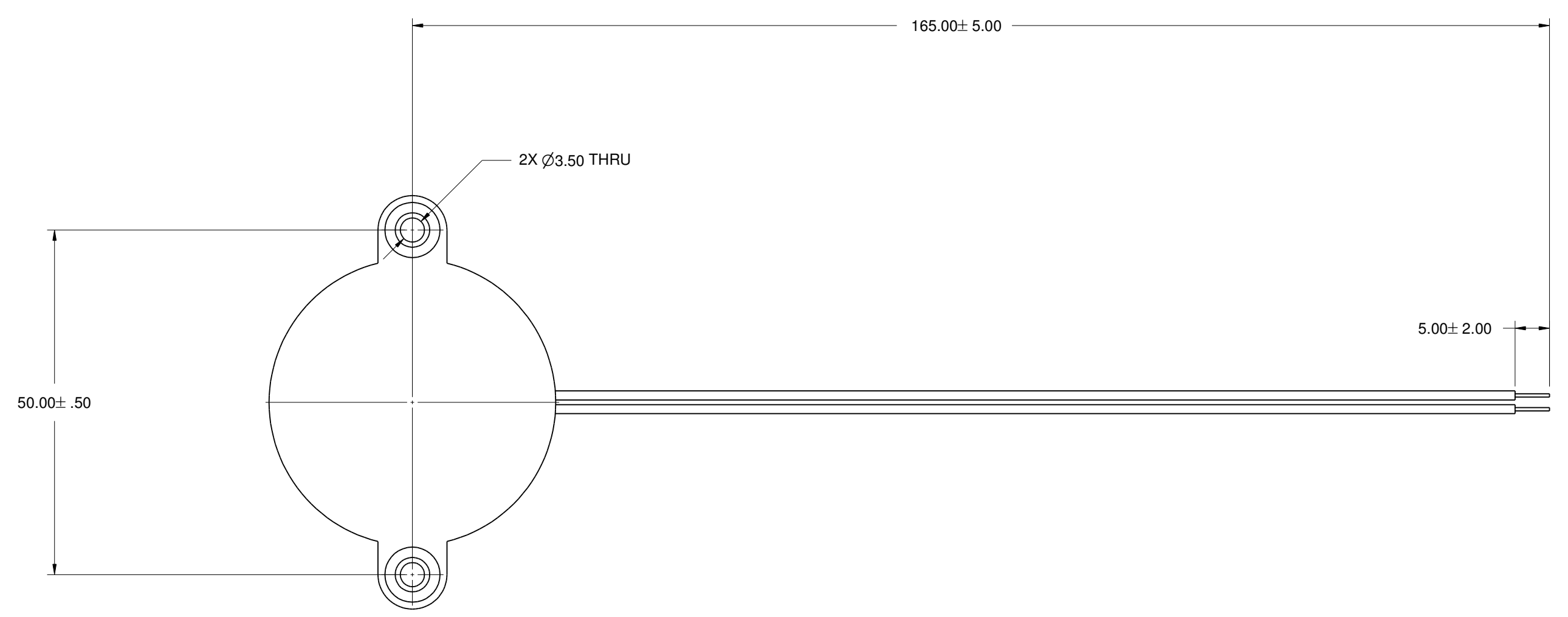
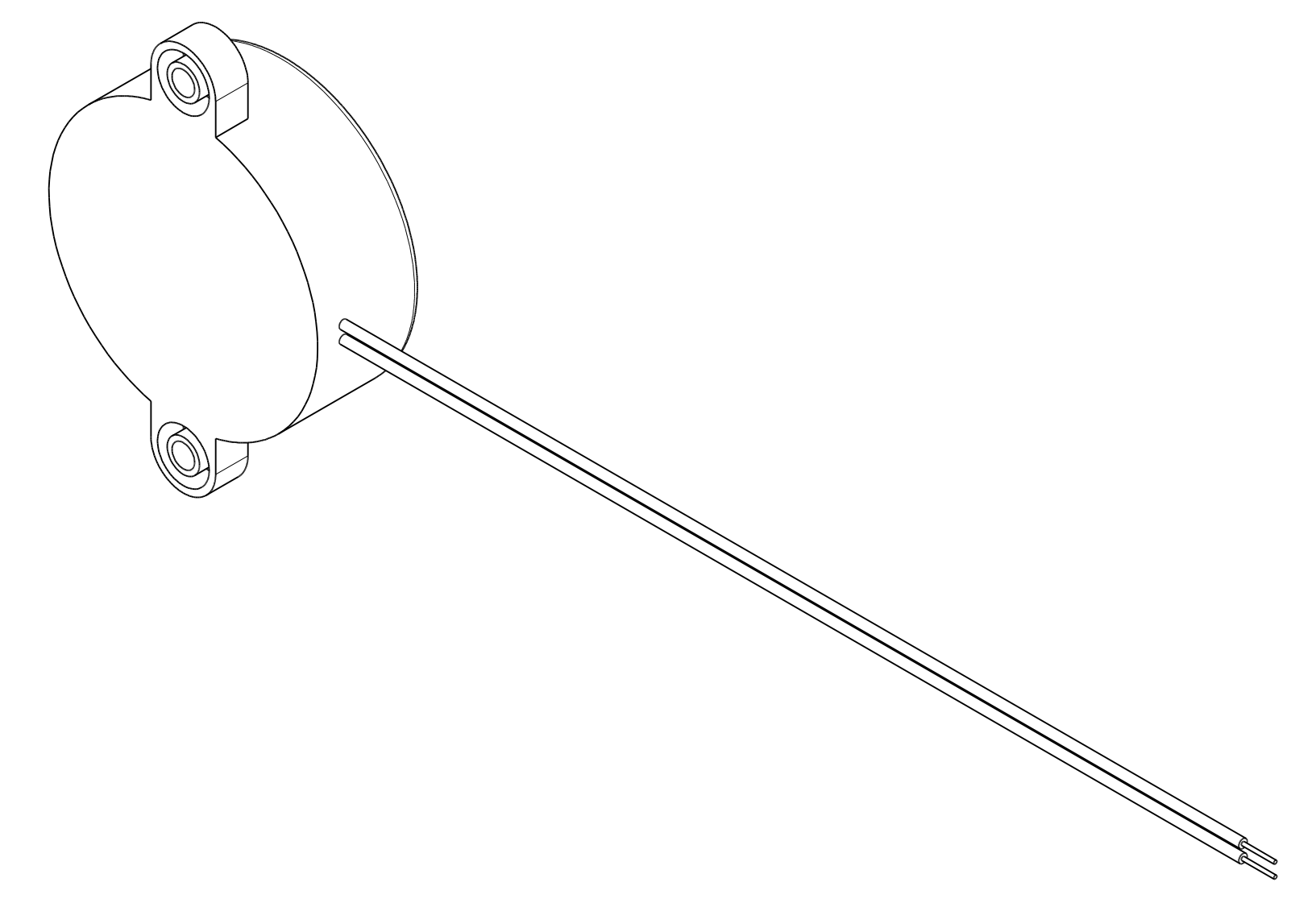

SIZE	FSCM NO.	DWG NO.	REV
D		PB-4216-2	
SCALE	1:1	SHEET	1 OF 1