

LINNEA-ZT25-B

Asymmetric beam for wall-washing optimized for 0.5 mm metal sheet or profile. Variant made from PC.

SPECIFICATION:

Dimensions	285.0 x 40.0 mm
Height	11.5 mm
Fastening	clips
ROHS compliant	yes ⓘ



MATERIALS:

Component	Type	Material	Colour	Finish
LINNEA-ZT25-B	Linear lens	PC	clear	

ORDERING INFORMATION:

Component	Qty in box	MOQ	MPQ	Box weight (kg)
F16000_LINNEA-ZT25-B » Box size: 398 x 298 x 265 mm	144	36	36	8.2

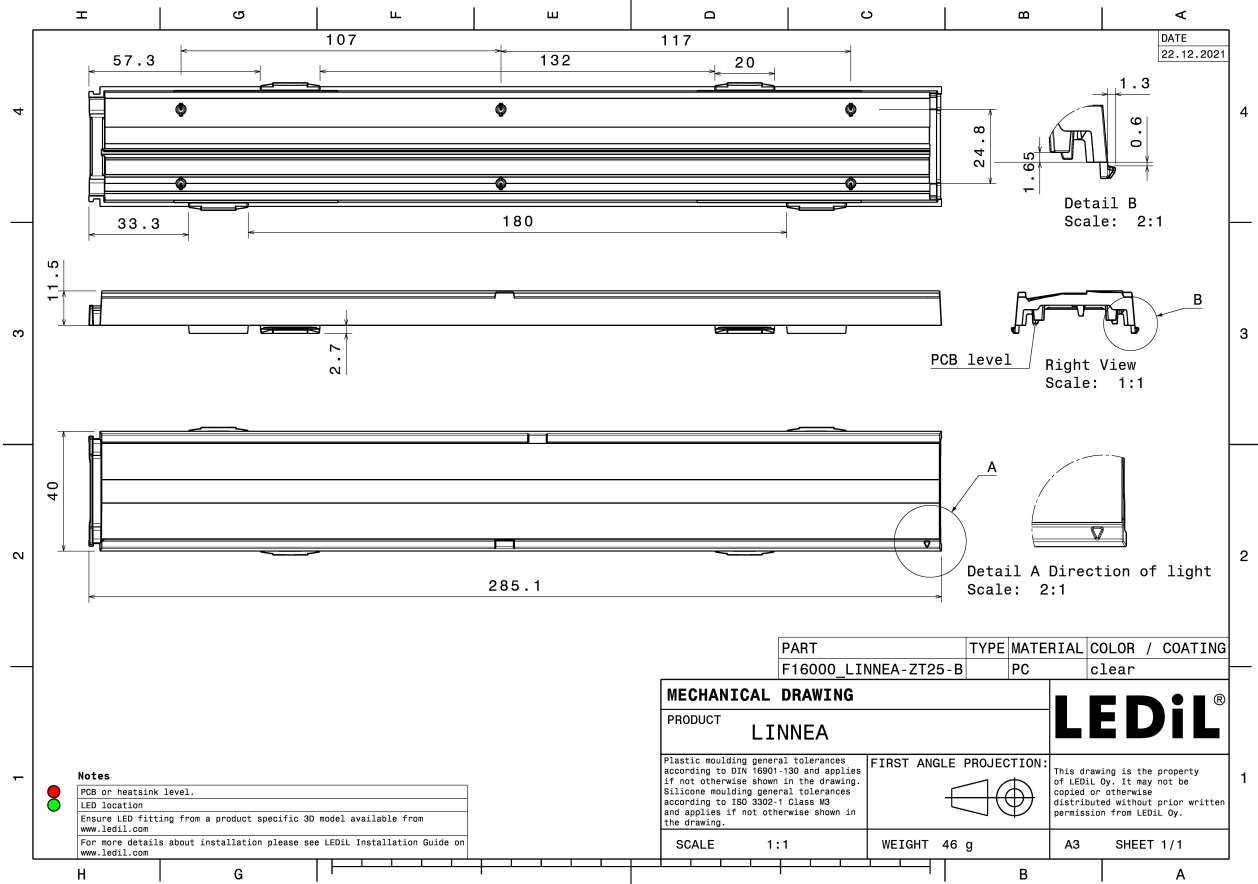

See also our general installation guide: www.ledil.com/installation_guide

OPTICAL RESULTS (MEASURED):



LED XP-E
FWHM / FWTM Asymmetric
Efficiency 80 %
Peak intensity 0.7 cd/m
LEDs/each optic 1
Light colour White
Required components:

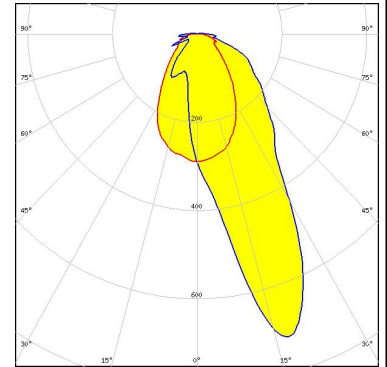

Helvar

LED L-iC-282-827-865-011A
FWHM / FWTM Asymmetric
Efficiency 81 %
Peak intensity 0.8 cd/m
LEDs/each optic 1
Light colour White
Required components:

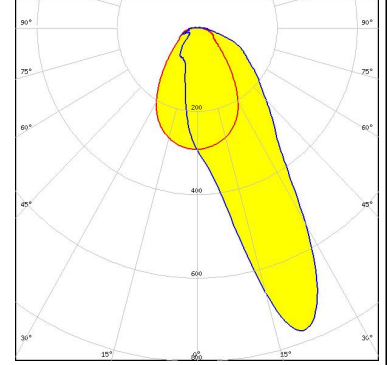

Helvar

LED LP-282-840-009A 60/300
FWHM / FWTM Asymmetric
Efficiency 81 %
Peak intensity 0.8 cd/m
LEDs/each optic 1
Light colour White
Required components:

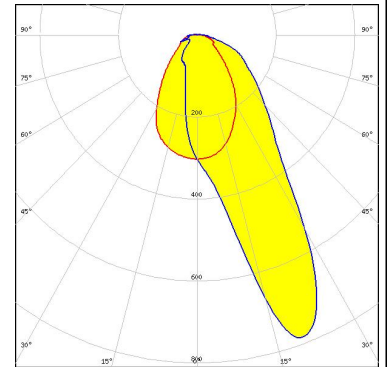

Helvar

LED LS-282-840-011A
FWHM / FWTM Asymmetric
Efficiency 80 %
Peak intensity 0.8 cd/m
LEDs/each optic 1
Light colour White
Required components:

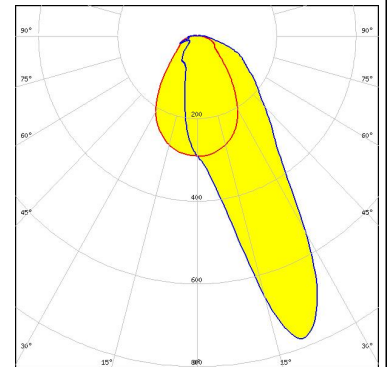

OPTICAL RESULTS (MEASURED):

Helvar

LED LX-282-840-023A
 FWHM / FWTM Asymmetric
 Efficiency 81 %
 Peak intensity 0.8 cd/lm
 LEDs/each optic 1
 Light colour White
 Required components:

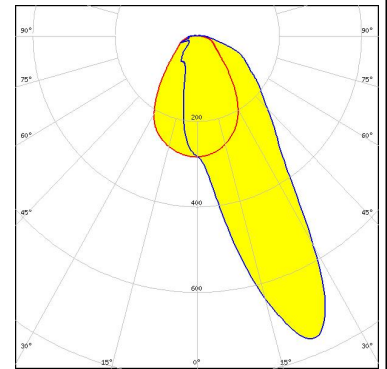

MST Your solutions

LED LinLED 280x24mm 1100lm 830 2C 30V LINNEA-GC G1
 FWHM / FWTM Asymmetric
 Efficiency 81 %
 Peak intensity 0.8 cd/lm
 LEDs/each optic 1
 Light colour White
 Required components:

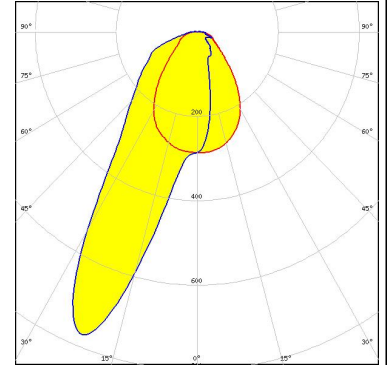

NICHIA

LED NFSW757H
 FWHM / FWTM Asymmetric
 Efficiency 82 %
 Peak intensity 0.6 cd/lm
 LEDs/each optic 1
 Light colour White
 Required components:

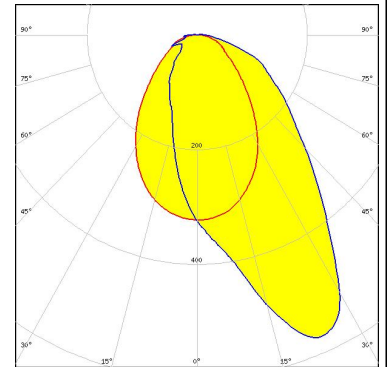

NICHIA

LED NFSx757G
 FWHM / FWTM Asymmetric
 Efficiency 80 %
 Peak intensity 0.8 cd/lm
 LEDs/each optic 1
 Light colour White
 Required components:

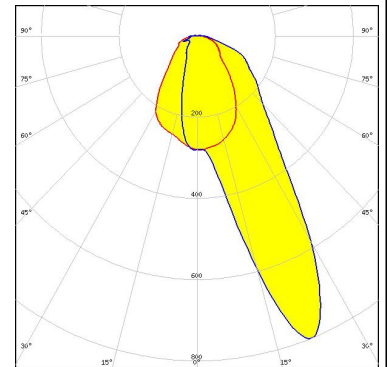

OPTICAL RESULTS (MEASURED):

OSRAM

Opto Semiconductors

LED Duris S5 (2 chip)
 FWHM / FWTM Asymmetric
 Efficiency 81 %
 Peak intensity 0.8 cd/lm
 LEDs/each optic 1
 Light colour White
 Required components:

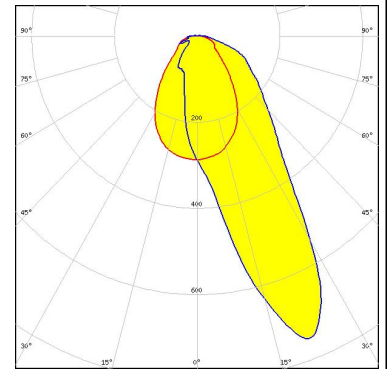

OSRAM

Opto Semiconductors

LED Duris S5 (Single chip)
 FWHM / FWTM Asymmetric
 Efficiency 83 %
 Peak intensity 0.8 cd/lm
 LEDs/each optic 1
 Light colour White
 Required components:

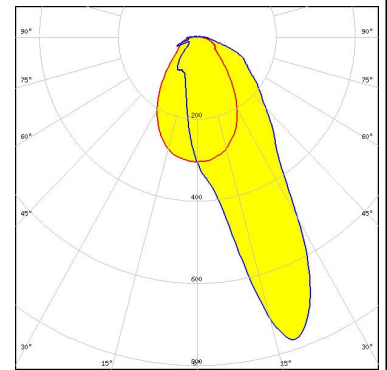

PHILIPS

LED Fortimo LED Strip 1ft 1100lm FC HV4 & LV4
 FWHM / FWTM Asymmetric
 Efficiency 80 %
 Peak intensity 0.6 cd/lm
 LEDs/each optic 1
 Light colour White
 Required components:

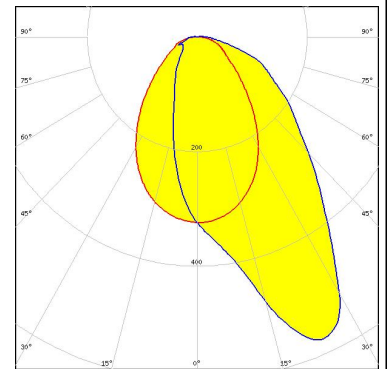

PHILIPS

LED Fortimo LED Strip 1ft 1100lm FC HV5 & LV5
 FWHM / FWTM Asymmetric
 Efficiency 82 %
 Peak intensity 0.6 cd/lm
 LEDs/each optic 1
 Light colour White
 Required components:

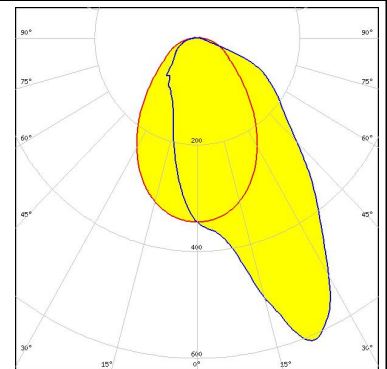

OPTICAL RESULTS (MEASURED):

PHILIPS

LED Fortimo LED Strip 1ft 650lm FC HV4 & LV4
 FWHM / FWTM Asymmetric
 Efficiency 81 %
 Peak intensity 0.6 cd/m
 LEDs/each optic 1
 Light colour White
 Required components:

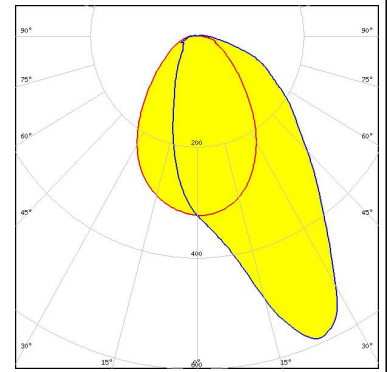

PHILIPS

LED Fortimo LED Strip 1ft 650lm FC HV5 & LV5
 FWHM / FWTM Asymmetric
 Efficiency 82 %
 Peak intensity 0.6 cd/m
 LEDs/each optic 1
 Light colour White
 Required components:

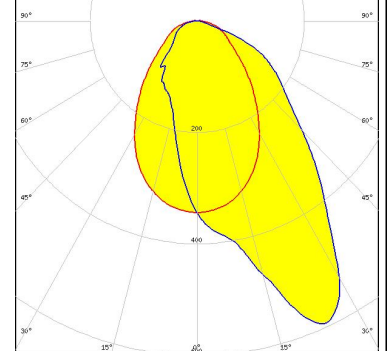

SAMSUNG

LED LM561B Plus
 FWHM / FWTM Asymmetric
 Efficiency 81 %
 Peak intensity 0.8 cd/m
 LEDs/each optic 1
 Light colour White
 Required components:

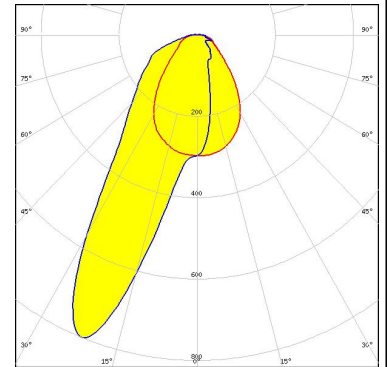

SAMSUNG

LED LT-H282C
 FWHM / FWTM Asymmetric
 Efficiency 81 %
 Peak intensity 0.6 cd/m
 LEDs/each optic 1
 Light colour White
 Required components:

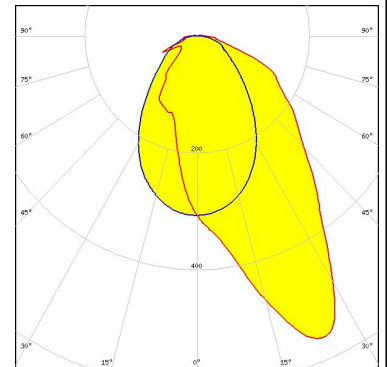

OPTICAL RESULTS (MEASURED):

SAMSUNG

LED LT-H562C
FWHM / FWTM Asymmetric
Efficiency 81 %
Peak intensity 0.6 cd/m
LEDs/each optic 1
Light colour White
Required components:

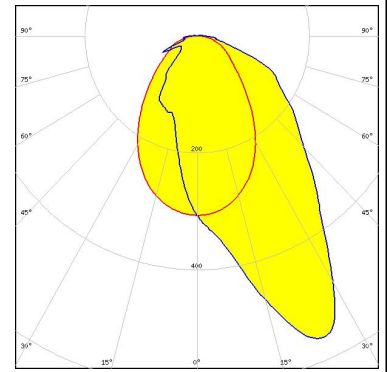

SAMSUNG

LED LT-Q282B
FWHM / FWTM Asymmetric
Efficiency 81 %
Peak intensity 0.6 cd/m
LEDs/each optic 1
Light colour White
Required components:

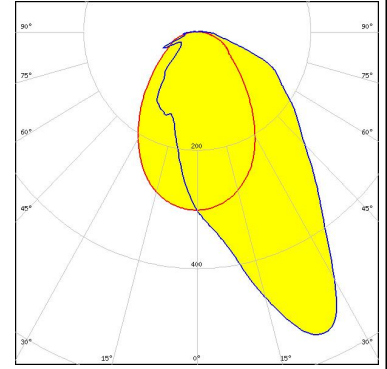

SAMSUNG

LED LT-S282H
FWHM / FWTM Asymmetric
Efficiency 81 %
Peak intensity 0.7 cd/m
LEDs/each optic 1
Light colour White
Required components:

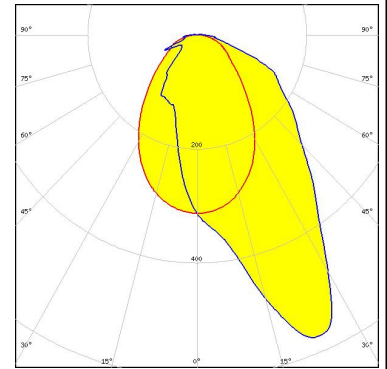

SAMSUNG

LED LT-S282H
FWHM / FWTM Asymmetric
Efficiency 81 %
Peak intensity 0.6 cd/m
LEDs/each optic 1
Light colour White
Required components:

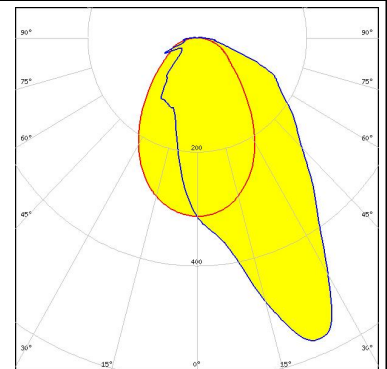

OPTICAL RESULTS (MEASURED):

SAMSUNG

LED LT-S562H
FWHM / FWTM Asymmetric
Efficiency 81 %
Peak intensity 0.7 cd/lm
LEDs/each optic 1
Light colour White
Required components:

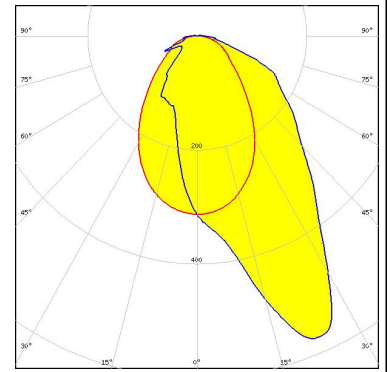

SAMSUNG

LED LT-S562H
FWHM / FWTM Asymmetric
Efficiency 81 %
Peak intensity 0.6 cd/lm
LEDs/each optic 1
Light colour White
Required components:

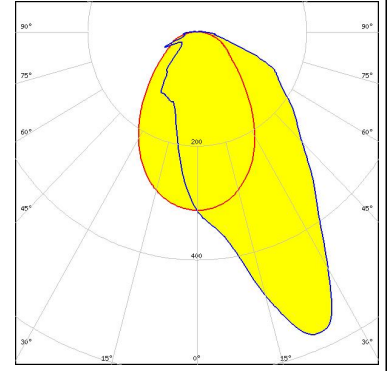

SAMSUNG

LED LT-V282E
FWHM / FWTM Asymmetric
Efficiency 81 %
Peak intensity 0.6 cd/lm
LEDs/each optic 1
Light colour White
Required components:

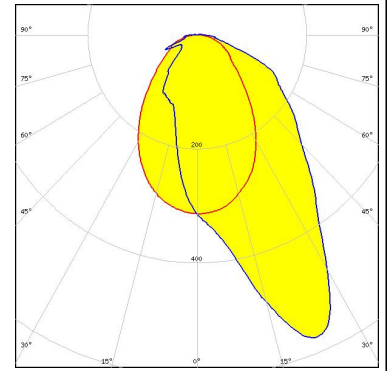

SAMSUNG

LED LT-V282E
FWHM / FWTM Asymmetric
Efficiency 82 %
Peak intensity 0.7 cd/lm
LEDs/each optic 1
Light colour White
Required components:

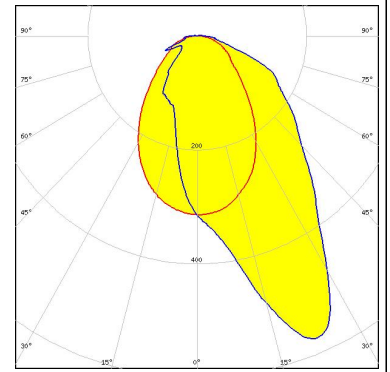

OPTICAL RESULTS (MEASURED):

SAMSUNG

LED LT-V562E
 FWHM / FWTM Asymmetric
 Efficiency 81 %
 Peak intensity 0.6 cd/lm
 LEDs/each optic 1
 Light colour White
 Required components:

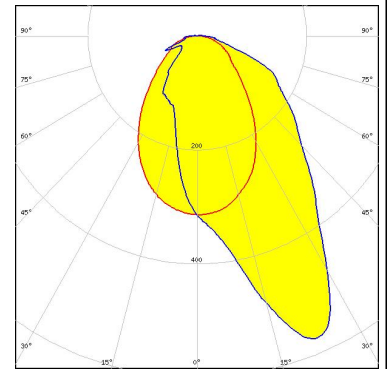

SAMSUNG

LED LT-V562E
 FWHM / FWTM Asymmetric
 Efficiency 82 %
 Peak intensity 0.7 cd/lm
 LEDs/each optic 1
 Light colour White
 Required components:

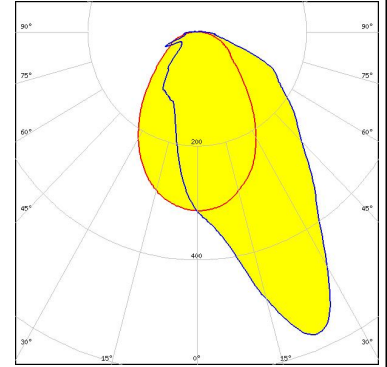

SEOUL SEMICONDUCTOR

LED SEOUL 5630D
 FWHM / FWTM Asymmetric
 Efficiency 80 %
 Peak intensity 0.7 cd/lm
 LEDs/each optic 1
 Light colour White
 Required components:

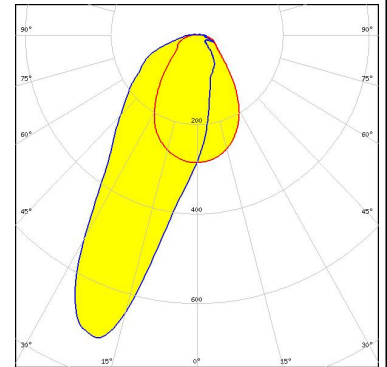

SEOUL SEMICONDUCTOR

LED SEOUL DC 3030
 FWHM / FWTM Asymmetric
 Efficiency 82 %
 Peak intensity 0.8 cd/lm
 LEDs/each optic 1
 Light colour White
 Required components:

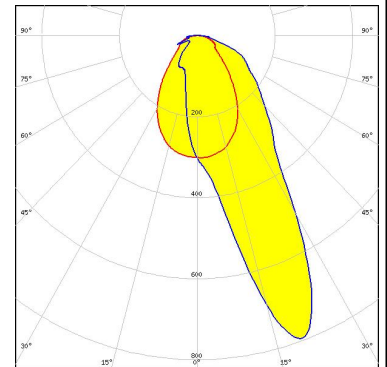

OPTICAL RESULTS (MEASURED):

TRIDONIC

LED LLE 24x280mm 650lm HV ADV5
FWHM / FWTM Asymmetric
Efficiency 81 %
Peak intensity 0.6 cd/lm
LEDs/each optic 1
Light colour White
Required components:

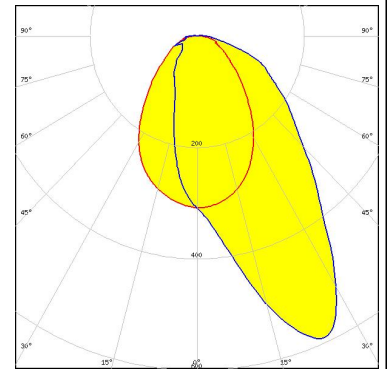

TRIDONIC

LED LLE G4 24x280mm 1250lm
FWHM / FWTM Asymmetric
Efficiency 81 %
Peak intensity 0.6 cd/lm
LEDs/each optic 1
Light colour White
Required components:

TRIDONIC

LED LLE G4 24x280mm 2000lm ADV
FWHM / FWTM Asymmetric
Efficiency 80 %
Peak intensity 0.6 cd/lm
LEDs/each optic 1
Light colour White
Required components:

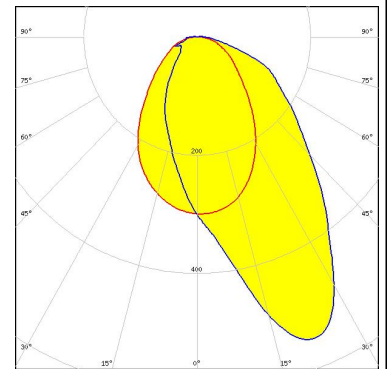

TRIDONIC

LED LLE G4 24x280mm 650lm
FWHM / FWTM Asymmetric
Efficiency 82 %
Peak intensity 0.8 cd/lm
LEDs/each optic 1
Light colour White
Required components:

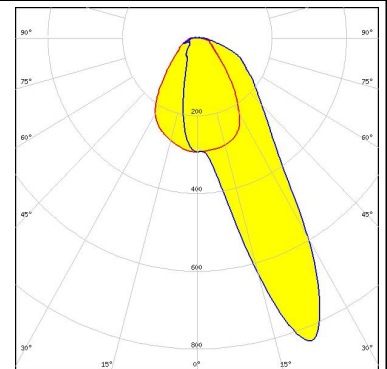

OPTICAL RESULTS (SIMULATED):

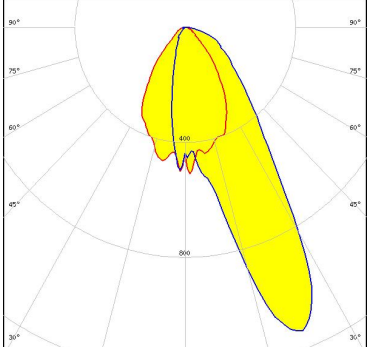
<p>NICHIA</p> <p>LED: NF2x757D FWHM / FWTM: Asymmetric Efficiency: 73 % LEDs/each optic: 1 Light colour: White Required components:</p>	
<p>SAMSUNG</p> <p>LED: LM561B FWHM / FWTM: Asymmetric Efficiency: 73 % LEDs/each optic: 1 Light colour: White Required components:</p>	

GENERAL INFORMATION:

NOTE: The typical beam angle will be changed by different color, chip size and chip position tolerance. The typical total beam angle is the full angle measured where the luminous intensity is half of the peak value.

MATERIALS:

As part of our continuous research and improvement processes, and to ensure the best possible quality and availability of our products, LEDiL reserves the right to change material grades without notice.

PRODUCT DATA USER AGREEMENT AND DISCLAIMER:

The measured data in the provided downloadable LEDiL Product Datasheets and Mechanical 2D-Drawings is rounded and provided as reference for planning. LEDiL Oy's optical specifications have been verified by conducting performance testing of the products in accordance with the company's quality system. The reported data are averaged results of multiple measurements with typical variation. LEDiL Oy reserves the right to without prior notification make changes and improvements to its products.

LEDiL Oy assumes neither warranty, nor guarantee nor any other liability of any kind for the contents and correctness of the provided data. The provided data has been generated with highest diligence but the provided data may in reality not represent the complete possible variation range of all intrinsic parameters. Therefore, in certain cases a deviation from the provided data could occur.

LEDiL Oy reserves the right to undertake technical changes of its products without further notification which could lead to changes in the provided data. LEDiL Oy assumes no liability of any kind for the possible deviation from any provided data or any other damage resulting from the usage of the provided data.

The user agrees to this disclaimer and user agreement with the download or usage of the provided files.

LEDiL Oy

Joensuunkatu 13
FI-24240 SALO
Finland

LEDiL Inc.

228 West Page Street
Suite D
Sycamore IL 60178
USA

Ledil Optics Technology (Shenzhen) Co., Ltd.

405 , Block B
Casic Motor Building
Shenzhen 518057
P.R.CHINA

Local sales and technical support

[www.ledil.com/
where_to_buy](http://www.ledil.com/where_to_buy)

Shipping locations

Salo, Finland
Hong Kong, China

Distribution Partners

[www.ledil.com/
where_to_buy](http://www.ledil.com/where_to_buy)