

Advantech

AQD-D4U8GE24-HE

Datasheet

Rev. 0.0

2016-12-13

Description

AQD-D4U8GE24-HE is a DDR4 2400Mbps ECC U-DIMM high-speed, memory module that use 18pcs of 1024Mx 8 bits DDR4 SDRAM in FBGA package and a 4K bits serial EEPROM on a 288-pin printed circuit board.

AQD-D4U8GE24-HE is a Dual In-Line Memory Module and is intended for mounting into 288-pin edge connector sockets.

Synchronous design allows precise cycle control with the use of system clock. Data I/O transactions are possible on both edges of DQS. Range of operation frequencies, programmable latencies allow the same device to be useful for a variety of high bandwidth, high performance memory system applications.

Features

- RoHS compliant products.
- JEDEC standard 1.2V(1.14V~1.26V) Power supply
VDDQ= 1.2V(1.14V~1.26V)
- VPP = 2.5V +0.25V / -0.125V
- Data transfer rates: PC3-12800
Programmable CAS Latency:
10,11,12,13,14,15,16,17,18
- 8 bit pre-fetch
- Burst Length (BL) switch on-the-fly BL8 or BC4
- Bi-directional Differential Data-Strobe
- On Die Termination, Nominal, Park, and Dynamic ODT
- Serial presence detect with EEPROM
Asynchronous reset
- PCB edge connector treated with 30u" Gold-Plating

Pin Identification

Symbol	Function
A0~A17 ¹ , BA0~BA1	Address/Bank input
DQ0~DQ63	Bi-direction data bus.

DQS0_t~DQS17_t	Data Buffer data strobes
DQS0_c~DQS17_c	Data Buffer data strobes
CK0_t, CK1_t	SDRAM clocks
CK0_c, CK1_c	SDRAM clocks
ODT0 & ODT1	On-die termination control line
CS0_n~CS3_n	DIMM Rank Select Lines input.
RAS_n ²	Row address strobe
CAS_n ³	Column address strobe
WE_n ⁴	Write Enable
DM0~DM7	Data masks/high data strobes
VDD	Core power supply
VDDQ	I/O driver power supply
V _{REF} CA	Command/address reference supply
V _{DD} SPD	SPD EEPROM power supply
SA0~SA2	I2C serial bus address select for EEPROM
SCL	I2C serial bus clock for EEPROM
SDA	I2C serial bus data for EEPROM
VSS	Ground
RESET_n	Set DRAMs Known State
VTT	DRAM I/O termination supply
VPP	SDRAM Supply
ALERT_n	SDRAM ALERT_n
EVENT_n	SPD signals a thermal event has occurred
RFU	Reserved for future use

1. Address A17 is not valid for x8 and x16 based SDRAMs. For UDIMMs this connection pin is NC.

2. RAS_n is a multiplexed function with A16.

3. CAS_n is a multiplexed function with A15.

4. WE_n is a multiplexed function with A14.

Dimensions (Unit: millimeter)

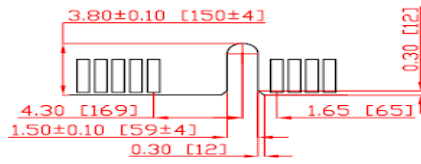
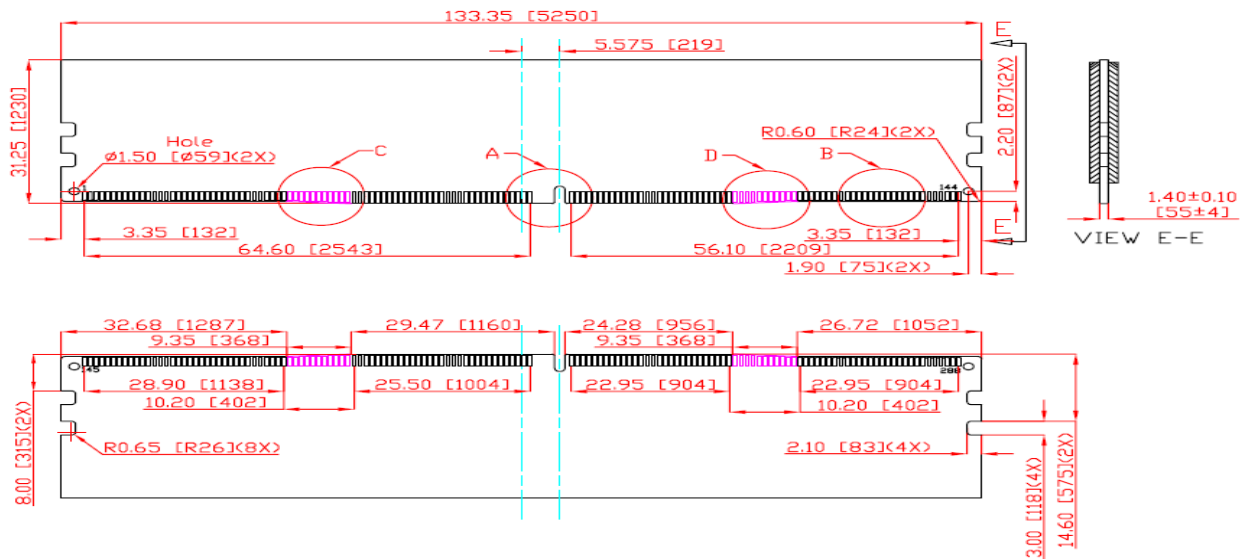
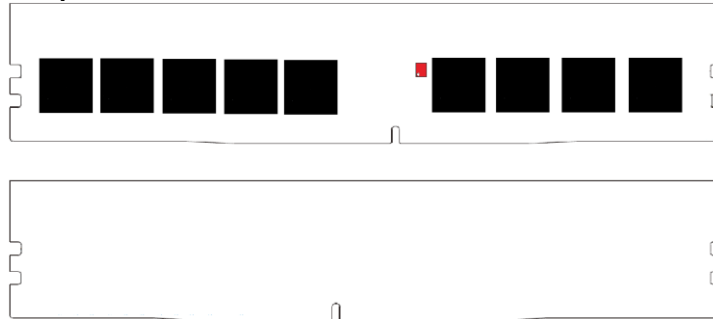

Detail A

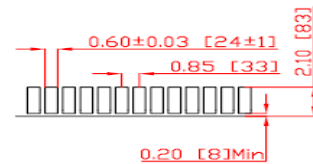

Detail B

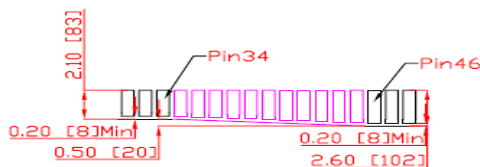

Detail C

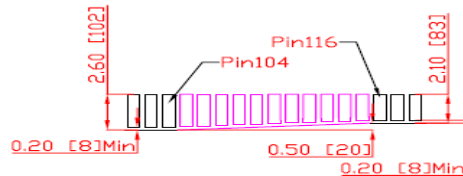

Detail D

Note:1. Tolerances on all dimensions +/-0.15mm unless otherwise specified.



Enabling an Intelligent Planet

288Pin DDR4 2400 1.2V U-DIMM

8GB Based on 1024Mx8

AQD-D4U8GE24-HE

Pin Assignments

Pin	Front	Pin	Front	Pin	Front	Pin	Back	Pin	Back	Pin	Back	Pin	Back	Pin	Back
1	12V	41	NC	81	BA0	121	DM6,DBI6	161	DQ9	201	CB3	241	VSS	281	VSS
2	VSS	42	VSS	82	RAS_n/A16	122	NC	162	VSS	202	VSS	242	DQ33	282	DQ59
3	DQ4	43	DQ30	83	VDD	123	VSS	163	DQS1C	203	CKE1	243	VSS	283	VSS
4	VSS	44	VSS	84	CS0_n	124	DQ54	164	DQS1T	204	VDD	244	DQS4C	284	VDDSPD
5	DQ0	45	DQ26	85	VDD	125	VSS	165	VSS	205	RFU	245	DQS4T	285	SDA
6	VSS	46	VSS	86	CAS_n/A15	126	DQ50	166	DQ15	206	VDD	246	VSS	286	VPP
7	DM0,DBI0	47	CB4	87	ODT0	127	VSS	167	VSS	207	BG1	247	DQ39	287	VPP
8	NC	48	VSS	88	VDD	128	DQ60	168	DQ11	208	ALERT_n	248	VSS	288	VPP
9	VSS	49	CB0	89	CS1_n	129	VSS	169	VSS	209	VDD	249	DQ35		
10	QD6	50	VSS	90	VDD	130	DQ56	170	DQ21	210	A11	250	VSS		
11	VSS	51	DM8,DBI8	91	ODT1	131	VSS	171	VSS	211	A7	251	DQ45		
12	DQ2	52	NC	92	VDD	132	DM7,DBI7	172	DQ17	212	VDD	252	VSS		
13	VSS	53	VSS	93	NC	133	NC	173	VSS	213	A5	253	DQ41		
14	DQ12	54	CB6	94	VSS	134	VSS	174	DQS2C	214	A4	254	VSS		
15	VSS	55	VSS	95	DQ36	135	DQ62	175	DQS2T	215	VDD	255	DQS5C		
16	DQ8	56	CB2	96	VSS	136	VSS	176	VSS	216	A2	256	DQS5T		
17	VSS	57	VSS	97	DQ32	137	DQ58	177	DQ23	217	VDD	257	VSS		
18	DM1,DBI1	58	RESET_n	98	VSS	138	VSS	178	VSS	218	CK1T	258	DQ47		
19	NC	59	VDD	99	DM4,DBI4	139	SA0	179	DQ19	219	CK1C	259	VSS		
20	VSS	60	CKE0	100	NC	140	SA1	180	VSS	220	VDD	260	DQ43		
21	DQ14	61	VDD	101	VSS	141	SCL	181	DQ29	221	VTT	261	VSS		
22	VSS	62	ACT_n	102	DQ38	142	VPP	182	VSS	222	PARITY	262	DQ53		
23	DQ10	63	BG0	103	VSS	143	VPP	183	DQ25	223	VDD	263	VSS		
24	VSS	64	VDD	104	DQ34	144	RFU	184	VSS	224	BA1	264	DQ49		
25	DQ20	65	A12/BC_n	105	VSS	145	12V	185	DQS3C	225	A10_AP	265	VSS		
26	VSS	66	A9	106	DQ44	146	VREFCA	186	DQS3T	226	VDD	266	DQS6C		
27	DQ16	67	VDD	107	VSS	147	VSS	187	VSS	227	RFU	267	DQS6T		
28	VSS	68	A8	108	DQ40	148	DQ8	188	DQ31	228	WE_n/A14	268	VSS		
29	DM2,DBI2	69	A6	109	VSS	149	VSS	189	VSS	229	VDD	269	DQ55		
30	NC	70	VDD	110	DM5,DBI5	150	DQ1	190	DQ27	230	NC	270	VSS		
31	VSS	71	A3	111	NC	151	VSS	191	VSS	231	VDD	271	DQ51		
32	DQ22	72	A1	112	VSS	152	DQS0C	192	CB5	232	A13	272	VSS		
33	VSS	73	VDD	113	DQ46	153	DQS0T	193	VSS	233	VDD	273	DQ61		
34	DQ18	74	CK0T	114	VSS	154	VSS	194	CB1	234	NC	274	VSS		
35	VSS	75	CK0C	115	DQ42	155	DQ7	195	VSS	235	NC	275	DQ57		
36	DQ28	76	VDD	116	VSS	156	VSS	196	DQS8C	236	VDD	276	VSS		
37	VSS	77	VTT	117	DQ52	157	DQ3	197	DQS8T	237	NC	277	DQS7C		
38	DQ24	78	EVENT_n	118	VSS	158	VSS	198	VSS	238	SA2	278	DQS7T		
39	VSS	79	A0	119	DQ48	159	DQ13	199	CB7	239	VSS	279	VSS		
40	DM3,DBI3	80	VDD	120	VSS	160	VSS	200	VSS	240	DQ37	280	DQ63		

8GB, 1024Mx9 Module (1 Rank x8)

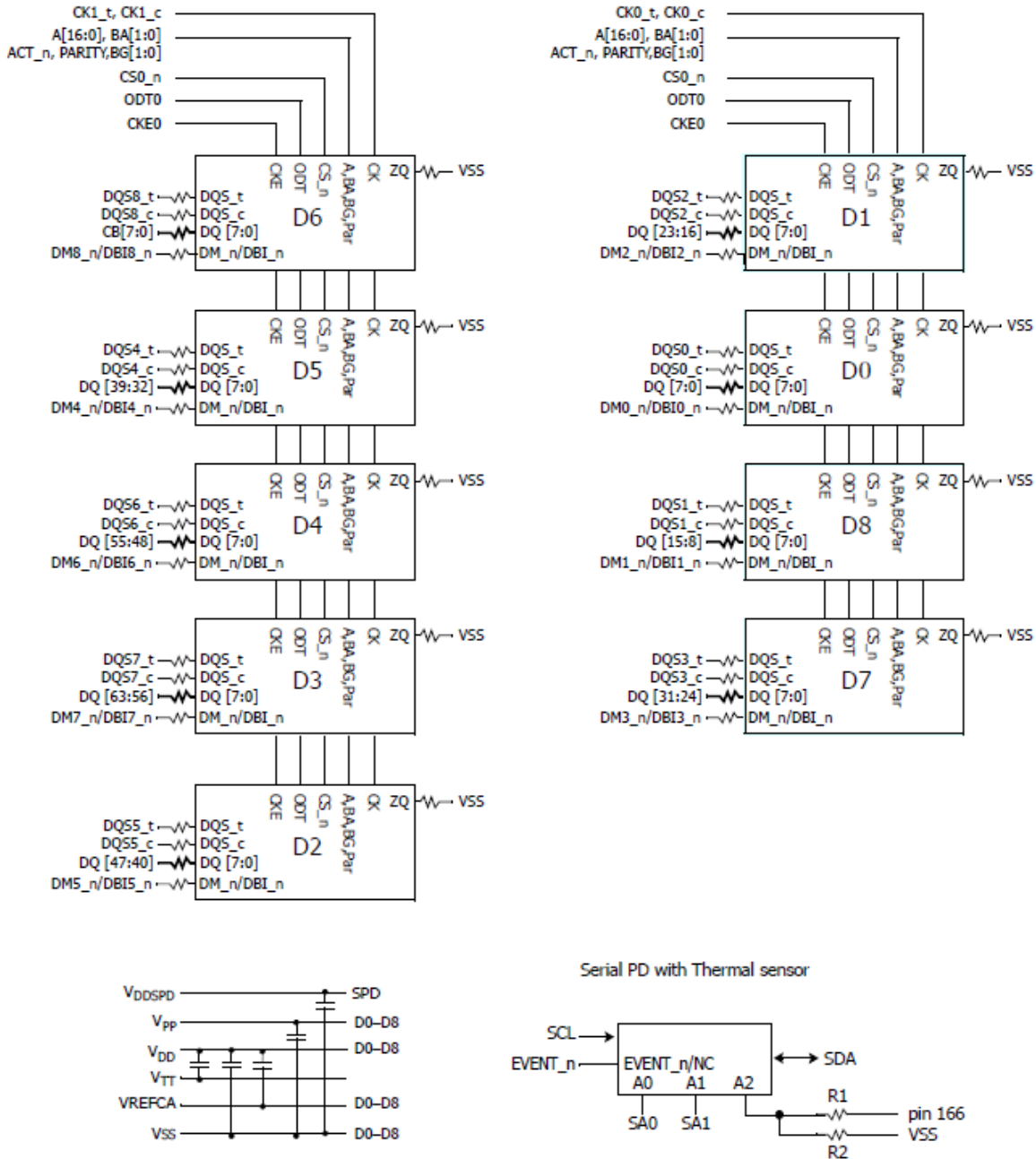

- This technical information is based on industry standard data and tests believed to be reliable. However, Advantech makes no warranties, either expressed or implied, as to its accuracy and assume no liability in connection with the use of this product. Advantech reserves the right to make changes in specifications at any time without prior notice.

Operating Temperature Condition

Parameter	Symbol	Rating	Unit	Note
Operating Temperature	TOPER	0 to 85	°C	1,2

Note: Operating Temperature is the case surface temperature on the center/top side of the DRAM. For the measurement conditions, please refer to JESD51-2 standard.

Absolute Maximum DC Ratings

Parameter	Symbol	Value	Unit	Note
Voltage on VDD relative to Vss	VDD	-0.3 ~ 1.5	V	1
Voltage on VDDQ pin relative to Vss	VDDQ	-0.3 ~ 1.5	V	1
Voltage on any pin relative to Vss	VIN, VOUT	-0.3 ~ 1.5	V	1
Storage temperature	TSTG	-55~+100	°C	1,2

Note: 1. Stress greater than those listed under “Absolute Maximum Ratings” may cause permanent damage to the device. This is a stress rating only and functional operation of the device at these or any other conditions above those indicated in the operational sections of this specification is not implied. Exposure to absolute maximum rating conditions for extended periods may affect reliability.
2. Storage Temperature is the case surface temperature on the center/top side of the DRAM. For the measurement conditions, please refer to JESD51-2 standard.

AC & DC Operating Conditions

Recommended DC operating conditions

Parameter	Symbol	Voltage	Rating			Unit	Notes
			Min	Typ.	Max		
Supply voltage	VDD	1.2V	1.14	1.2	1.26	V	1,2,3
Supply voltage for Output	VDDQ	1.2V	1.14	1.2	1.26	V	1,2,3
I/O Reference Voltage (DQ)	VREF _{DQ} (DC)	1.2V	0.49*VDD	0.50*VDD	0.51*VDD	V	4
I/O Reference Voltage (CMD/ADD)	VREF _{CA} (DC)	1.2V	0.49*VDD	0.50*VDD	0.51*VDD	V	4
AC Input Logic High	VIH(AC)	1.2V	VREF+100	-	VDD ²	mV	
AC Input Logic Low	VIL(AC)	1.2V	VSS ²	-	VREF-100	mV	
DC Input Logic High	VIH(DC)	1.2V	VREF+75	-	VDD	mV	
DC Input Logic Low	VIL(DC)	1.2V	VSS	-	VREF-75	mV	

Note: (1) Under all conditions VDDQ must be less than or equal to VDD.
(2) VDDQ tracks with VDD. AC parameters are measured with VDD and VDDQ tied together.
(3) The DC bandwidth is limited to 200MHz.
(4) The AC peak noise on VREF may not allow VREF to deviate from VREF(DC) by more than ±1% VDD (for reference: approx. ±12mV)

IDD Specification parameters Definition - 8GB (1 Rank x8)

Parameter	Symbol	DDR4 2400 CL17	Unit
One bank ACTIVATE-PRECHARGE current	IDD0 ¹	342	mA
One bank ACTIVATE-PRECHARGE, wordline boost, IPP current	IPP0 ¹	54	mA
One Bank Active-Read-Precharge Current	IDD1 ¹	432	mA
Precharge Standby Current	IDD2N ²	243	mA
Precharge standby ODT current	IDD2NT ¹	288	mA
Precharge Power-Down Current	IDD2P ²	162	mA
Precharge Quiet Standby Current	IDD2Q ²	198	mA
Active standby current	IDD3N ²	408	mA
Active standby IPP current	IPP3N ²	135	mA
Active Power-Down Current	IDD3P ²	333	mA
Burst Read Current	IDD4R ¹	1116	mA
Burst write current	IDD4W ¹	1080	mA
Burst refresh current (1x REF)	IDD5B ¹	1746	mA
Burst refresh IPP current (1x REF)	IPP5B ¹	585	mA
Self refresh current: Normal temperature range (0–85°C)	IDD6N ²	198	mA
Self refresh current: Extended temperature range (0–95°C)	IDD6E ²	252	mA
Bank interleave read current	IDD7 ¹	1368	mA
Bank interleave read IPP current	IPP7 ¹	171	mA
Maximum power-down current	IDD8 ²	108	mA

Note: 1. One module rank in the active IDD/PP, the other rank in IDD2P/PP3N.
2. All ranks in this IDD/PP condition.
3. IDD current measure method and detail patterns are described on DDR4 component datasheet. Only for reference.

■ **Timing Parameters & Specifications**



Enabling an Intelligent Planet

288Pin DDR4 2400 1.2V U-DIMM

8GB Based on 1024Mx8

AQD-D4U8GE24-HE

Speed		DDR4-1866		DDR4-2133		DDR4-2400		Units	NOTE
Parameter	Symbol	MIN	MAX	MIN	MAX	MIN	MAX		
Clock Timing									
Minimum Clock Cycle Time (DLL off mode)	tCK (DLL OFF)	8	-	8	-	8	20	ns	22
Average Clock Period	tCK(avg)	1.071	<1.25	0.938	<1.071	0.833	<0.938	ps	35,36
Average high pulse width	tCH(avg)	0.48	0.52	0.48	0.52	0.48	0.52	tCK(avg)	
Average low pulse width	tCL(avg)	0.48	0.52	0.48	0.52	0.48	0.52	tCK(avg)	
Absolute Clock Period	tCK(abs)	tCK(avg)min + tJIT(per)min_tot	tCK(avg)max + tJIT(per)max_tot	tCK(avg)min + tJIT(per)min_tot	tCK(avg)max + tJIT(per)max_tot	tCK(avg)min + tJIT(per)min_tot	tCK(avg)max + tJIT(per)max_tot	tCK(avg)	
Absolute clock HIGH pulse width	tCH(abs)	0.45	-	0.45	-	0.45	-	tCK(avg)	23
Absolute clock LOW pulse width	tCL(abs)	0.45	-	0.45	-	0.45	-	tCK(avg)	24
Clock Period Jitter- total	tJIT(per)_tot	-54	54	-0.1	0.1	-42	42	ps	23
Clock Period Jitter- deterministic	tJIT(per)_dj	-27	27	TBD	TBD	-21	21	ps	26
Clock Period Jitter during DLL locking period	tJIT(per)_lck	-43	43	TBD	TBD	-33	33	ps	
Cycle to Cycle Period Jitter	tJIT(cc)_total		107		94		83	ps	25
Cycle to Cycle Period Jitter deterministic	tJIT(cc)_dj		54		47		42	ps	26
Cycle to Cycle Period Jitter during DLL locking period	tJIT(cc)_lck		86		75		67	ps	
Duty Cycle Jitter	tJIT(duty)	TBD	TBD	TBD	TBD	TBD	TBD	ps	
Cumulative error across 2 cycles	tERR(2per)	-79	79	-69	69	-61	61	ps	
Cumulative error across 3 cycles	tERR(3per)	-94	94	-82	82	-73	73	ps	
Cumulative error across 4 cycles	tERR(4per)	-104	104	-91	91	-81	81	ps	
Cumulative error across 5 cycles	tERR(5per)	-112	112	-98	98	-87	87	ps	
Cumulative error across 6 cycles	tERR(6per)	-119	119	-104	104	-92	92	ps	
Cumulative error across 7 cycles	tERR(7per)	-124	124	-109	109	-97	97	ps	
Cumulative error across 8 cycles	tERR(8per)	-129	129	-113	113	-101	101	ps	
Cumulative error across 9 cycles	tERR(9per)	-134	134	-117	117	-104	104	ps	
Cumulative error across 10 cycles	tERR(10per)	-137	137	-120	120	-107	107	ps	
Cumulative error across 11 cycles	tERR(11per)	-141	141	-123	123	-110	110	ps	
Cumulative error across 12 cycles	tERR(12per)	-144	144	-126	126	-112	112	ps	
Cumulative error across 13 cycles	tERR(13per)	-147	147	-129	129	-114	114	ps	
Cumulative error across 14 cycles	tERR(14per)	-150	150	-131	131	-116	116	ps	
Cumulative error across 15 cycles	tERR(15per)	-152	152	-133	133	-118	118	ps	
Cumulative error across 16 cycles	tERR(16per)	-155	155	-135	135	-120	120	ps	
Cumulative error across 17 cycles	tERR(17per)	-157	157	-137	137	-122	122	ps	
Cumulative error across 18 cycles	tERR(18per)	-159	159	-139	139	-124	124	ps	
Cumulative error across n = 13, 14 ... 49, 50 cycles	tERR(nper)	$tERR(nper)min = ((1 + 0.68ln(n)) * tJIT(per)_total min)$ $tERR(nper)max = ((1 + 0.68ln(n)) * tJIT(per)_total max)$						ps	
Command and Address setup time to CK_t, CK_c referenced to Vih(ac) / Vil(ac) levels	tIS(base)	100	-	80	-	62	-	ps	
Command and Address setup time to CK_t, CK_c referenced to Vref levels	tIS(Vref)	200	-	180	-	162	-	ps	
Command and Address hold time to CK_t, CK_c referenced to Vih(dc) / Vil(dc) levels	tIH(base)	125	-	105	-	87	-	ps	
Command and Address hold time to CK_t, CK_c referenced to Vref levels	tIH(Vref)	200	-	180	-	162	-	ps	
Control and Address Input pulse width for each input	tIPW	525	-	460	-	410	-	ps	
Command and Address Timing									
CAS_n to CAS_n command delay for same bank group	tCCD_L	max(5 nCK, 6.250 ns)	-	max(5 nCK, 6.250 ns)	-	max(5 nCK, 6.250 ns)	-	nCK	34
CAS_n to CAS_n command delay for different bank group	tCCD_S	4	-	4	-	4	-	nCK	34
ACTIVATE to ACTIVATE Command delay to different bank group for 2KB page size	tRRD_S(2K)	Max(4nCK,5.3ns)	-	Max(4nCK,5.3ns)	-	Max(4nCK,5.3ns)	-	nCK	34
ACTIVATE to ACTIVATE Command delay to different bank group for 1KB page size	tRRD_S(1K)	Max(4nCK,4.2ns)	-	Max(4nCK,3.7ns)	-	Max(4nCK,3.3ns)	-	nCK	34
ACTIVATE to ACTIVATE Command delay to different bank group for 1/2KB page size	tRRD_S(1/2K)	Max(4nCK,4.2ns)	-	Max(4nCK,3.7ns)	-	Max(4nCK,3.3ns)	-	nCK	34
ACTIVATE to ACTIVATE Command delay to same bank group for 2KB page size	tRRD_L(2K)	Max(4nCK,6.4ns)	-	Max(4nCK,6.4ns)	-	Max(4nCK,6.4ns)	-	nCK	34
ACTIVATE to ACTIVATE Command delay to same bank group for 1KB page size	tRRD_L(1K)	Max(4nCK,5.3ns)	-	Max(4nCK,5.3ns)	-	Max(4nCK,4.9ns)	-	nCK	34
ACTIVATE to ACTIVATE Command delay to same bank group for 1/2KB page size	tRRD_L(1/2K)	Max(4nCK,5.3ns)	-	Max(4nCK,5.3ns)	-	Max(4nCK,4.9ns)	-	nCK	34
Four activate window for 2KB page size	tFAW_2K	Max(28nCK,30ns)	-	Max(28nCK,30ns)	-	Max(28nCK,30ns)	-	ns	34
Four activate window for 1KB page size	tFAW_1K	Max(20nCK,23ns)	-	Max(20nCK,21ns)	-	Max(20nCK,21ns)	-	ns	34
Four activate window for 1/2KB page size	tFAW_1/2K	Max(16nCK,17ns)	-	Max(16nCK,15ns)	-	Max(16nCK,13ns)	-	ns	34
Delay from start of internal write transaction to internal read command for different bank group	tWTR_S	max(2nCK,2.5ns)	-	Max(28nCK,30ns)	-	max(2nCK, 2.5ns)	-		1,2,e,34
Delay from start of internal write transaction to internal read command for same bank group	tWTR_L	max(4nCK,7.5ns)	-	Max(20nCK,21ns)	-	max(4nCK,7.5ns)	-		1,34
Internal READ Command to PRECHARGE Command delay	tRTP	max(4nCK,7.5ns)	-	Max(16nCK,13ns)	-	max(4nCK,7.5ns)	-		
WRITE recovery time	tWR	15	-	15	-	15	-	ns	1



Enabling an Intelligent Planet

288Pin DDR4 2400 1.2V U-DIMM

8GB Based on 1024Mx8

AQD-D4U8GE24-HE

Speed		DDR4-1866		DDR4-2133		DDR4-2400		Units	NOTE
Parameter	Symbol	MIN	MAX	MIN	MAX	MIN	MAX		
Write recovery time when CRC and DM are enabled	tWR_CRC_DM	tWR+max (5nCK,3.75ns)	-	tWR+max (5nCK,3.75ns)	-	tWR+max (5nCK,3.75ns)	-	ns	1, 28
delay from start of internal write transaction to internal read command for different bank group with both CRC and DM enabled	tWTR_S_C RC_DM	tWTR_S+max (5nCK,3.75ns)	-	tWTR_S+max (5nCK,3.75ns)	-	tWTR_S+max (5nCK,3.75ns)	-	ns	2, 29,34
delay from start of internal write transaction to internal read command for same bank group with both CRC and DM enabled	tWTR_L_C RC_DM	tWTR_L+max (5nCK,3.75ns)	-	tWTR_L+max (5nCK,3.75ns)	-	tWTR_L+max (5nCK,3.75ns)	-	ns	3,30,34
DLL locking time	tDLLK	597	-	768	-	768	-	nCK	
Mode Register Set command cycle time	tMRD	8	-	8	-	8	-	nCK	
Mode Register Set command update delay	tMOD	max(24nCK,15ns)	-	max(24nCK,15ns)	-	max(24nCK,15ns)	-		
Multi-Purpose Register Recovery Time	tMPRR	1	-	1	-	1	-	nCK	33
Multi Purpose Register Write Recovery Time	tWR_MPR	tMOD (min) + AL + PL	-	tMOD (min) + AL + PL	-	tMOD (min) + AL + PL	-		
Auto precharge write recovery + precharge time	tDAL(min)	Programmed WR + roundup (tRP / tCK(avg))						nCK	
DQ0 or DQL0 driven to 0 set-up time to first DQS rising edge	tPDA_S	0.5	-	0.5	-	0.5	-	UI	45,47
DQ0 or DQL0 driven to 0 hold time from last DQS fall-ing edge	tPDA_H	0.5	-	0.5	-	0.5	-	UI	45,47
CS_n to Command Address Latency									
CS_n to Command Address Latency	tCAL	4	-	4	-	5	-	nCK	
DRAM Data Timing									
DQS_t,DQS_c to DQ skew, per group, per access	tDQSQ	-	0.16	-	0.16	-	0.16	tCK(avg)/2	13,18
DQ output hold time from DQS_t,DQS_c	tQH	0.76	-	0.76	-	0.76	-	tCK(avg)/2	13,17,18
Data Valid Window per device: tQH - tDQSQ for a device	tDVVd	0.63	-	0.64	-	0.64	-	UI	16,17,18
Data Valid Window per device, per pin: tQH - tDQSQ each device' s output	tDVWp	0.66	-	0.69	-	0.72	-	UI	16,17,18
Data Strobe Timing									
DQS_t, DQS_c differential READ Preamble	tRPRE	0.9	NOTE44	0.9	NOTE44	0.9	NOTE44	tCK	40
DQS_t, DQS_c differential READ Postamble	tRPST	0.33	TBD	0.33	TBD	0.33	TBD	tCK	41
DQS_t,DQS_c differential output high time	tQSH	0.4	-	0.4	-	0.4	-	tCK	
DQS_t,DQS_c differential output low time	tQSL	0.4	-	0.4	-	0.4	-	tCK	21
DQS_t, DQS_c differential WRITE Preamble	tWPRE	0.9	-	0.9	-	0.9	-	tCK	20
DQS_t, DQS_c differential WRITE Postamble	tWPST	0.33	TBD	0.33	TBD	0.33	TBD	tCK	42
DQS_t and DQS_c low-impedance time (Referenced from RL-1)	tLZ(DQS)	-390	195	-360	180	-300	150	tCK	43
DQS_t and DQS_c high-impedance time (Referenced from RL+BL/2)	tHZ(DQS)	-	195	-	180	-	150	tCK	
DQS_t, DQS_c differential input low pulse width	tDQSL	0.46	0.54	0.46	0.54	0.46	0.54	ps	
DQS_t, DQS_c differential input high pulse width	tDQSH	0.46	0.54	0.46	0.54	0.46	0.54	ps	
DQS_t, DQS_c rising edge to CK_t, CK_c rising edge (1 clock preamble)	tDQSS	-0.27	0.27	-0.27	0.27	-0.27	0.27	tCK	
DQS_t, DQS_c falling edge setup time to CK_t, CK_c rising edge	tDSS	0.18	-	0.18	-	0.18	-	tCK	
DQS_t, DQS_c falling edge hold time from CK_t, CK_c rising edge	tDSH	0.18	-	0.18	-	0.18	-	tCK	
DQS_t, DQS_c rising edge output timing locatino from rising CK_t, CK_c with DLL On mode	tDQSCK (DLL On)	-195	195	-180	180	-175	175	ps	37,38,39
DQS_t, DQS_c rising edge output variance window per DRAM	tDQSCKI (DLL On)	-	330	-	310	-	290	ps	37,38,39
MPSM Timing									
Command path disable delay upon MPSM entry	tMPED	tMOD(min) + tCPDED(min)	-	tMOD(min) + tCPDED(min)	-	tMOD(min) + tCPDED(min)	-		
Valid clock requirement after MPSM entry	tCKMPE	tMOD(min) + tCPDED(min)	-	tMOD(min) + tCPDED(min)	-	tMOD(min) + tCPDED(min)	-		
Valid clock requirement before MPSM exit	tCKMPX	tCKSRX(min)	-	tCKSRX(min)	-	tCKSRX(min)	-		
Exit MPSM to commands not requiring a locked DLL	tXMP	txs(imin)	-	txs(imin)	-	txs(imin)	-		
Exit MPSM to commands requiring a locked DLL	tXMPDLL	tXMP(min) + tXSDLL(min)	-	tXMP(min) + tXSDLL(min)	-	tXMP(min) + tXSDLL(min)	-		
CS setup time to CKE	tMPX_S	tSmin + tHmin	-	tSmin + tHmin	-	tSmin + tHmin	-		
Calibration Timing									
Power-up and RESET calibration time	tZQinit	1024	-	1024	-	1024	-	nCK	
Normal operation Full calibration time	tZQoper	512	-	512	-	512	-	nCK	
Normal operation Short calibration time	tZQCS	128	-	128	-	128	-	nCK	
Reset/Self Refresh Timing									
Exit Reset from CKE HIGH to a valid command	tXPR	max (5nCK,tRFC(min)+10ns)	-	max (5nCK,tRFC(min)+10ns)	-	max (5nCK,tRFC(min)+10ns)	-		
Exit Self Refresh to commands not requiring a locked DLL	tXS	tRFC(min)+10ns	-	tRFC(min)+10ns	-	tRFC(min)+10ns	-		
SRX to commands not requiring a locked DLL in Self Refresh ABORT	tXS_ABORT(min)	tRFC4(min)+10ns	-	tRFC4(min)+10ns	-	tRFC4(min)+10ns	-		
Exit Self Refresh to ZQCL,ZQCS and MRS (CL,CWL,WR,RTP and Gear Down)	tXS_FAST (min)	tRFC4(min)+10ns	-	tRFC4(min)+10ns	-	tRFC4(min)+10ns	-		

Speed	Parameter	Symbol	DDR4-1866		DDR4-2133		DDR4-2400		Units	NOTE
			MIN	MAX	MIN	MAX	MIN	MAX		
	Exit Self Refresh to commands requiring a locked DLL	tXSDLL	tDLLK(min)	-	tDLLK(min)	-	tDLLK(min)	-		
	Minimum CKE low width for Self refresh entry to exit timing	tCKESR	tCKE(min)+1nCK	-	tCKE(min)+1nCK	-	tCKE(min)+1nCK	-		
	Minimum CKE low width for Self refresh entry to exit timing with CA Parity enabled	tCKESR_PAR	tCKE(min)+1nCK+PL	-	tCKE(min)+1nCK+PL	-	tCKE(min)+1nCK+PL	-		
	Valid Clock Requirement after Self Refresh Entry (SRE) or Power-Down Entry (PDE)	tCKSRE	max(5nCK,10ns)	-	max(5nCK,10ns)	-	max(5nCK,10ns)	-		
	Valid Clock Requirement after Self Refresh Entry (SRE) or Power-Down when CA Parity is enabled	tCKSRE_PAR	max(5nCK,10ns)+PL	-	max(5nCK,10ns)+PL	-	max(5nCK,10ns)+PL	-		
	Valid Clock Requirement before Self Refresh Exit (SRX) or Power-Down Exit (PDX) or Reset Exit	tCKSRX	max(5nCK,10ns)	-	max(5nCK,10ns)	-	max(5nCK,10ns)	-		
Power Down Timing										
	Exit Power Down with DLL on to any valid command; Exit Precharge Power Down with DLL frozen to commands not requiring a locked DLL	tXP	max(4nCK,6ns)	-	max(4nCK,6ns)	-	max(4nCK,6ns)	-		
	CKE minimum pulse width	tCKE	max(3nCK,5ns)	-	max(3nCK,5ns)	-	max(3nCK,5ns)	-		31,32
	Command pass disable delay	tCPDED	4	-	4	-	4	-	nCK	
	Power Down Entry to Exit Timing	tPD	tCKE(min)	9*tREFI	tCKE(min)	9*tREFI	tCKE(min)	9*tREFI		6
	Timing of ACT command to Power Down entry	tACTPDEN	1	-	2	-	2	-	nCK	7
	Timing of PRE or PREA command to Power Down entry	tPRPDEN	1	-	2	-	2	-	nCK	7
	Timing of RD/RDA command to Power Down entry	tRDPDEN	RL+4+1	-	RL+4+1	-	RL+4+1	-	nCK	
	Timing of WR command to Power Down entry (BL8OTF, BL8MRS, BC4OTF)	tWRPDEN	WL+4+(tWR/tCK(avg))	-	WL+4+(tWR/tCK(avg))	-	WL+4+(tWR/tCK(avg))	-	nCK	4
	Timing of WRA command to Power Down entry (BL8OTF, BL8MRS, BC4OTF)	tWRAPDEN	WL+4+WR+1	-	WL+4+WR+1	-	WL+4+WR+1	-	nCK	5
	Timing of WR command to Power Down entry (BC4MRS)	tWRPBC4DEN	WL+2+(tWR/tCK(avg))	-	WL+2+(tWR/tCK(avg))	-	WL+2+(tWR/tCK(avg))	-	nCK	4
	Timing of WRA command to Power Down entry (BC4MRS)	tWRAPBC4DEN	WL+2+WR+1	-	WL+2+WR+1	-	WL+2+WR+1	-	nCK	5
	Timing of REF command to Power Down entry	tREFPDEN	1	-	2	-	2	-	nCK	7
	Timing of MRS command to Power Down entry	tMRSPDEN	tMOD(min)	-	tMOD(min)	-	tMOD(min)	-		
PDA Timing										
	Mode Register Set command cycle time in PDA mode	tMRD_PDA	max(16nCK,10ns)		max(16nCK,10ns)		max(16nCK,10ns)			
	Mode Register Set command update delay in PDA mode	tMOD_PDA	tMOD		tMOD		tMOD			
ODT Timing										
	Asynchronous RTT turn-on delay (Power-Down with DLL frozen)	tAONAS	1.0	9.0	1.0	9.0	1.0	9.0	ns	
	Asynchronous RTT turn-off delay (Power-Down with DLL frozen)	tAOFAS	1.0	9.0	1.0	9.0	1.0	9.0	ns	
	RTT dynamic change skew	tADC	0.3	0.7	0.3	0.7	0.3	0.7	tCK(avg)	
Write Leveling Timing										
	First DQS _t /DQS _n rising edge after write leveling mode is programmed	tWLMRD	40	-	40	-	40	-	nCK	12
	DQS _t /DQS _n delay after write leveling mode is programmed	tWLDQSEN	25	-	25	-	25	-	nCK	12
	Write leveling setup time from rising CK _t , CK _c crossing to rising DQS _t /DQS _n crossing	tWLS	0.13	-	0.13	-	0.13	-	tCK(avg)	
	Write leveling hold time from rising DQS _t /DQS _n crossing to rising CK _t , CK _c crossing	tWLH	0.13	-	0.13	-	0.13	-	tCK(avg)	
	Write leveling output delay	tWLO	0	9.5	0	9.5	0	9.5	ns	
	Write leveling output error	tWLOE							ns	
CA Parity Timing										
	Commands not guaranteed to be executed during this time	tPAR_UNKNOWN	-	Max(2nCK,3ns)	-	Max(2nCK,3ns)	-	Max(2nCK,3ns)		
	Delay from errant command to ALERT _n assertion	tPAR_ALERT_ON	-	PL+6ns	-	PL+6ns	-	PL+6ns		
	Pulse width of ALERT _n signal when asserted	tPAR_ALERT_PW	56	112	64	128	72	144	nCK	
	Time from when Alert is asserted till controller must start providing DES commands in Persistent CA parity mode	tPAR_ALERT_RSP	-	50	-	57	-	64	nCK	
	Parity Latency	PL	4		4		5		nCK	
CRC Error Reporting										
	CRC error to ALERT _n latency	tCRC_ALERT	3	13	3	13	3	13	ns	
	CRC ALERT _n pulse width	CRC_ALERT_PW	6	10	6	10	6	10	nCK	
tREFI										
tRFC1 (min)	2Gb	160	-	160	-	160	-	160	ns	
	4Gb	260	-	260	-	260	-	260	ns	
	8Gb	350	-	350	-	350	-	350	ns	
	16Gb	TBD	-	TBD	-	TBD	-	TBD	ns	
tRFC2 (min)	2Gb	110	-	110	-	110	-	110	ns	
	4Gb	160	-	160	-	160	-	160	ns	
	8Gb	260	-	260	-	260	-	260	ns	
	16Gb	TBD	-	TBD	-	TBD	-	TBD	ns	
tRFC4 (min)	2Gb	90	-	90	-	90	-	90	ns	
	4Gb	110	-	110	-	110	-	110	ns	
	8Gb	160	-	160	-	160	-	160	ns	
	16Gb	TBD	-	TBD	-	TBD	-	TBD	ns	



Enabling an Intelligent Planet

288Pin DDR4 2400 1.2V U-DIMM
8GB Based on 1024Mx8
AQD-D4U8GE24-HE

SERIAL PRESENCE DETECT SPECIFICATION (AQD-D4U8GE24-HE Serial Presence Detect)

Byte	Function Described	Function	HEX Value
0	Number of Bytes Used / Number of Bytes in SPD Device / CRC Coverage	SPD Total: 512Bytes, SPD Used : 384Bytes	23
1	SPD Revision	Version 1.1	11
2	Key Byte / DRAM Device Type	DDR4 SDRAM	0C
3	Key Byte / Module Type	UDIMM	02
4	SDRAM Density and Banks	4 bank group / 4 bank 8Gb	85
5	SDRAM Addressing	Row : 16 Column : 10	21
6	SDRAM Package Type	Mono / Not specified	00
7	SDRAM Optional Features	Unlimited MAC	08
8	SDRAM Thermal and Refresh Options	-	00
9	Other SDRAM Optional Features	PPR supported	40
10	Reserved	-	00
11	Module Nominal Voltage, VDD	1.2v	03
12	Module Organization	1Rank x8	01
13	Module Memory Bus Width	8bit ECC 64bits	0B
14	Module Thermal Sensor	Thermal Sensor on module	80
15-16	Reserved	-	00
17	Timebases	MTB: 125ps FTB: 1ps	00
18	SDRAM Minimum Cycle Time (tCKAVGmin)	0.833 ns	07
19	SDRAM Maximum Cycle Time (tCKAVGmax)	1.6 ns	0D
20	CAS Latencies Supported, First Byte	CL 10,11,12,13,14	F8
21	CAS Latencies Supported, Second Byte	CL 15,16,17,18	0F
22	CAS Latencies Supported, Third Byte	-	00
23	CAS Latencies Supported, Fourth Byte	-	00
24	Minimum CAS Latency Time(tAmin)	13.75 ns	6E
25	Minimum RAS to CAS Delay Time (tRCDmin)	13.75 ns	6E
26	Minimum Row Precharge Delay Time (tRPmin)	13.75 ns	6E
27	Upper Nibbles for tRASmin and tRCmin	-	11
28	Minimum Active to Precharge Delay Time (tRASmin), Least Significant Byte	32 ns	00
29	Minimum Active to Active/Refresh Delay Time (tRCmin), Least Significant Byte	45.75 ns	6E
30	Minimum Refresh Recovery Delay Time (tRFC1min), Least Significant Byte	350 ns	F0
31	Minimum Refresh Recovery Delay Time (tRFC1min), Most Significant Byte	350 ns	0A
32	Minimum Refresh Recovery Delay Time (tRFC2min), Least Significant Byte	260 ns	20
33	Minimum Refresh Recovery Delay Time (tRFC2min), Most Significant Byte	260 ns	08
34	Minimum Refresh Recovery Delay Time (tRFC4min), Least Significant Byte	160 ns	00
35	Minimum Refresh Recovery Delay Time (tRFC4min), Most Significant Byte	160 ns	05
36	Minimum Four Activate Window Time (tFAWmin), Most Significant Nibble	21 ns	00
37	Minimum Four Activate Window Time (tFAWmin), Least Significant Byte	21 ns	A8
38	Minimum Activate to Activate Delay Time (tRRD_Smin), different bank group	3.3 ns	1B
39	Minimum Activate to Activate Delay Time (tRRD_Lmin), same bank group	4.9 ns	28
40	Minimum CAS to CAS Delay Time (tCCD_Lmin), same bank group	5 ns	28
41	Upper Nibble for tWRmin	15 ns	00
42	Minimum Write Recovery Time (tWRmin)	15 ns	78
43	Upper Nibbles for tWTRmin	2.5 ns	00
44	Minimum Write to Read Time (tWTR_Smin), different bank group	2.5 ns	14
45	Minimum Write to Read Time (tWTR_Lmin), same bank group	7.5 ns	3C
46-59	Reserved, Base Configuration Section	-	00
60	Connector to SDRAM Bit Mapping	DQ0, DQ1, DQ2, DQ3	16
61	Connector to SDRAM Bit Mapping	DQ4, DQ5, DQ6, DQ7	36
62	Connector to SDRAM Bit Mapping	DQ8, DQ9, DQ10, DQ11	16
63	Connector to SDRAM Bit Mapping	DQ12, DQ13, DQ14, DQ15	36
64	Connector to SDRAM Bit Mapping	DQ16, DQ17, DQ18, DQ19	16
65	Connector to SDRAM Bit Mapping	DQ20, DQ21, DQ22, DQ23	36
66	Connector to SDRAM Bit Mapping	DQ24, DQ25, DQ26, DQ27	16
67	Connector to SDRAM Bit Mapping	DQ28, DQ29, DQ30, DQ31	36
68	Connector to SDRAM Bit Mapping	CB0-3	16
69	Connector to SDRAM Bit Mapping	CB4-7	36
70	Connector to SDRAM Bit Mapping	DQ32, DQ33, DQ34, DQ35	16
71	Connector to SDRAM Bit Mapping	DQ36, DQ37, DQ38, DQ39	36
72	Connector to SDRAM Bit Mapping	DQ40, DQ41, DQ42, DQ43	16
73	Connector to SDRAM Bit Mapping	DQ44, DQ45, DQ46, DQ47	36
74	Connector to SDRAM Bit Mapping	DQ48, DQ49, DQ50, DQ51	16
75	Connector to SDRAM Bit Mapping	DQ52, DQ53, DQ54, DQ55	36
76	Connector to SDRAM Bit Mapping	DQ56, DQ57, DQ58, DQ59	16
77	Connector to SDRAM Bit Mapping	DQ60, DQ61, DQ62, DQ63	36
78-116	Reserved, Base Configuration Section	-	00

Byte	Function Described	Function	HEX Value
117	Fine Offset for Minimum CAS to CAS Delay Time(tCCD_Lmin), same bank group	0 ns	00
118	Fine Offset for Minimum Activate to Activate Delay Time(tRRD_Lmin), different bank group	-0.1 ns	9C
119	Fine Offset for Minimum Activate to Activate Delay Time(tRRD_Smin), same bank group	-0.076 ns	B4
120	Fine Offset for Minimum Activate to Activate/Refresh Delay Time(tRCmin)	0 ns	00
121	Fine Offset for Minimum Row Precharge Delay Time(tRPmin)	0 ns	00
122	Fine Offset for Minimum RAS to CAS Delay Time(tRCDmin)	0 ns	00
123	Fine Offset for Minimum CAS Latency Time(tAmin)	0 ns	00
124	Fine Offset for SDRAM Maximum Cycle Time(tCKAVGmax)	-0.025ns	E7
125	Fine Offset for SDRAM Minimum Cycle Time(tCKAVGmin)	-0.042ns	D6
126	Cyclical Redundancy Code for Base Configuration Section, LSB	CRC-CCITT(LOW)	5A
127	Cyclical Redundancy Code for Base Configuration Section, MSB	CRC-CCITT(HIGH)	8E
128	(Unbuffered): Raw Card Extension, Module Nominal Height	Revision 1 31.25 mm	11
129	(Unbuffered): Module Maximum Thickness	-	01
130	(Unbuffered): Reference Raw Card Used	Raw Card D Revision 1	23
131	(Unbuffered): Address Mapping from Edge Connector to DRAM	Standard	00
132~253	(Unbuffered): Reserved	-	00
254	(Unbuffered): CRC for Module Specific Section, Least Significant Byte	CRC-CCITT(LOW)	56
255	(Unbuffered): CRC for Module Specific Section, Most Significant Byte	CRC-CCITT(HIGH)	BD
256~319	Hybrid Memory Architecture Specific Parameters		00
320	Module Manufacturer ID Code, LSB	ADATA	04
321	Module Manufacturer ID Code, MSB		CB
322	Module ID: Module Manufacturing Location	*Note: 1	-
323	Module ID: Module Manufacturing Date(Year)	*Note: 2	-
324	Module ID: Module Manufacturing Date(Week)	*Note: 3	-
325~328	Module ID : Module Serial Number	*Note: 4	-
329~348	Module Part Number	*Note: 5	-
349	Module Revision Code	-	00
350	SDRAM Manufacturer's JEDEC ID Code, LSB	Hynix	80
351	SDRAM Manufacturer's JEDEC ID Code, MSB		AD
352	DRAM Stepping	-	FF
353~381	Manufacturer's Specific Data	*Note: 6	-
382	Reserved		00
383	Reserved		00
384~511	End User Programmable	*Note: 7	-

- Note :
- Byte 322 -- Manufacturing location by manufacturing location (00:Taiwan /01:China)
 - Byte 323 -- Module manufacturing date by year (YY).
 - Byte 324 -- Module manufacturing date by week (WW).
 - Bytes 325~328 -- Module Serial Number.
 - Bytes 329~348 -- Manufacturer Part Number by module part number , (Unused digits are coded as ASCII blanks (20h)).
 - Bytes 353~381 -- These bytes are undefined and can be used for ADATA's own purpose. Digits are coded as 00h except the following:
 - Bytes 353~367 -- Manufacturer's Specific Data by working order number.
 - Bytes 368~381 -- Manufacturer's Specific Data by SPD naming number.
 - Bytes 384~511 -- These bytes are undefined and can be used for ADATA's own purpose. Digits are coded as 00h except the following:
 - Bytes 384 -- The byte is coded as ADh.