

Single IGBTMOD™ U-Series Module 600 Amperes/600 Volts

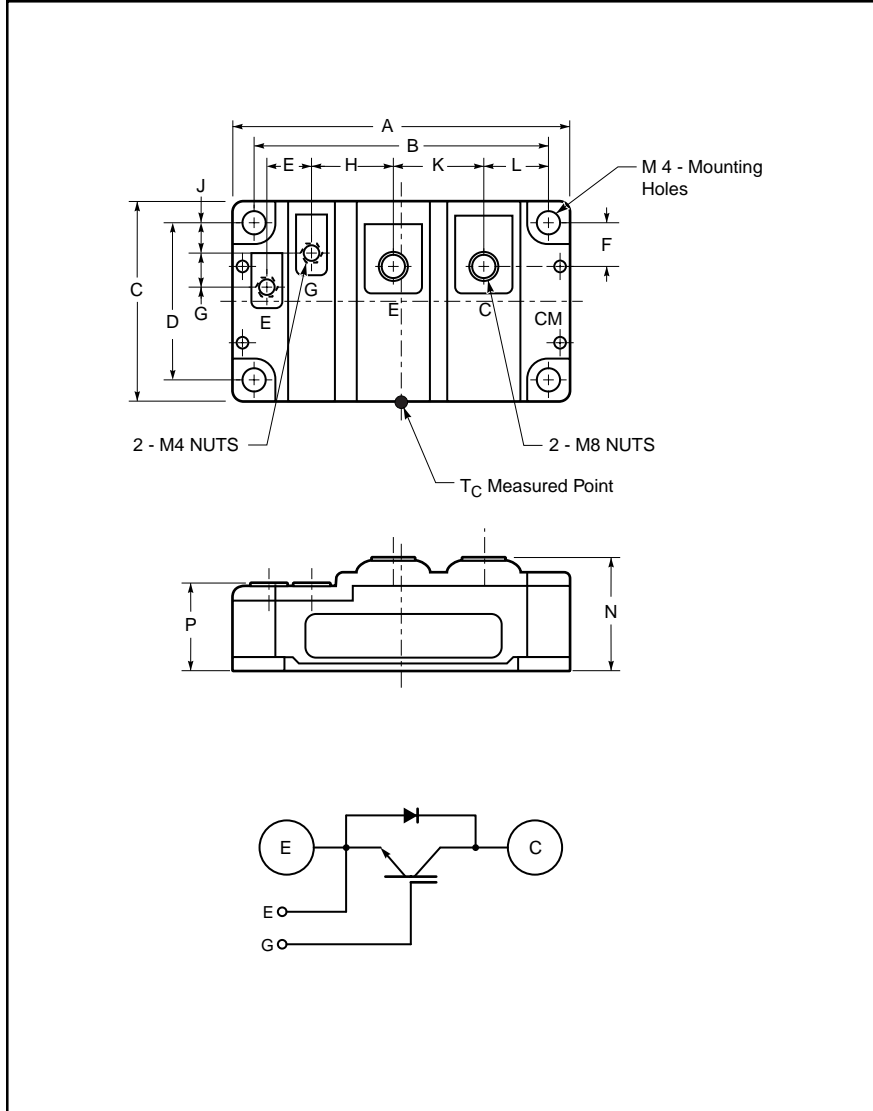

Outline Drawing and Circuit Diagram

Dimensions	Inches	Millimeters
A	4.21	107.0
B	3.66±0.01	93.0±0.25
C	2.44	62.0
D	1.89±0.01	48.0±0.25
E	0.53	13.5
F	0.49	12.55
G	0.39	10.0

Dimensions	Inches	Millimeters
H	1.02	26.0
J	0.37	9.5
K	1.14	29.0
L	0.81	20.5
M	0.26 Dia.	6.5 Dia.
N	1.34 +0.04/-0.02	34 +1.0/-0.5
P	1.02 +0.04/-0.02	26 +1.0/-0.5



Description:

Powerex IGBTMOD™ Modules are designed for use in switching applications. Each module consists of one IGBT Transistor in a single configuration with a reverse-connected super-fast recovery free-wheel diode. All components and interconnects are isolated from the heat sinking baseplate, offering simplified system assembly and thermal management.

Features:

- Low Drive Power
- Low $V_{CE(sat)}$
- Discrete Super-Fast Recovery Free-Wheel Diode
- Isolated Baseplate for Easy Heat Sinking

Applications:

- AC Motor Control
- Motion/Servo Control
- UPS
- Welding Power Supplies
- Laser Power Supplies

Ordering Information:

Example: Select the complete module number you desire from the table - i.e. CM600HU-12H is a 600V (V_{CES}), 600 Ampere Single IGBTMOD™ Power Module.

Type	Current Rating Amperes	V_{CES} Volts (x 50)
CM	600	12

CM600HU-12H
Single IGBTMOD™ U-Series Module
 600 Amperes/600 Volts

Absolute Maximum Ratings, $T_j = 25^\circ\text{C}$ unless otherwise specified

Ratings	Symbol	CM600HU-12H	Units
Junction Temperature	T_j	-40 to 150	$^\circ\text{C}$
Storage Temperature	T_{stg}	-40 to 125	$^\circ\text{C}$
Collector-Emitter Voltage (G-E SHORT)	V_{CES}	600	Volts
Gate-Emitter Voltage (C-E SHORT)	V_{GES}	± 20	Volts
Collector Current ($T_c = 25^\circ\text{C}$)	I_c	600	Amperes
Peak Collector Current ($T_j \leq 150^\circ\text{C}$)	I_{CM}	1200*	Amperes
Emitter Current** ($T_c = 25^\circ\text{C}$)	I_E	600	Amperes
Peak Emitter Current**	I_{EM}	1200*	Amperes
Maximum Collector Dissipation ($T_c = 25^\circ\text{C}$)	P_c	1560	Watts
Mounting Torque, M8 Main Terminal	–	95	in-lb
Mounting Torque, M6 Mounting	–	40	in-lb
Mounting Torque, M4 Terminal	–	15	in-lb
Weight	–	450	Grams
Isolation Voltage (Main Terminal to Baseplate, AC 1 min.)	V_{ISO}	2500	Volts

* Pulse width and repetition rate should be such that the device junction temperature (T_j) does not exceed $T_{j(\text{max})}$ rating.

**Represents characteristics of the anti-parallel, emitter-to-collector free-wheel diode (FWDi).

Static Electrical Characteristics, $T_j = 25^\circ\text{C}$ unless otherwise specified

Characteristics	Symbol	Test Conditions	Min.	Typ.	Max.	Units
Collector-Cutoff Current	I_{CES}	$V_{\text{CE}} = V_{\text{CES}}, V_{\text{GE}} = 0\text{V}$	–	–	1	mA
Gate Leakage Voltage	I_{GES}	$V_{\text{GE}} = V_{\text{GES}}, V_{\text{CE}} = 0\text{V}$	–	–	0.5	μA
Gate-Emitter Threshold Voltage	$V_{\text{GE(th)}}$	$I_c = 60\text{mA}, V_{\text{CE}} = 10\text{V}$	4.5	6	7.5	Volts
Collector-Emitter Saturation Voltage	$V_{\text{CE(sat)}}$	$I_c = 600\text{A}, V_{\text{GE}} = 15\text{V}, T_j = 25^\circ\text{C}$	–	2.4	3.0	Volts
		$I_c = 600\text{A}, V_{\text{GE}} = 15\text{V}, T_j = 125^\circ\text{C}$	–	2.6	–	Volts
Total Gate Charge	Q_G	$V_{\text{CC}} = 300\text{V}, I_c = 600\text{A}, V_{\text{GE}} = 15\text{V}$	–	1200	–	nC
Emitter-Collector Voltage*	V_{EC}	$I_E = 600\text{A}, V_{\text{GE}} = 0\text{V}$	–	–	2.6	Volts

* Pulse width and repetition rate should be such that the device junction temperature (T_j) does not exceed $T_{j(\text{max})}$ rating.

Dynamic Electrical Characteristics, $T_j = 25^\circ\text{C}$ unless otherwise specified

Characteristics	Symbol	Test Conditions	Min.	Typ.	Max.	Units
Input Capacitance	C_{ies}		–	–	52.8	nf
Output Capacitance	C_{oes}	$V_{\text{CE}} = 10\text{V}, V_{\text{GE}} = 0\text{V}$	–	–	28.8	nf
Reverse Transfer Capacitance	C_{res}		–	–	7.8	nf
Resistive Load	Turn-on Delay Time	$V_{\text{CC}} = 300\text{V}, I_c = 600\text{A}, V_{\text{GE1}} = V_{\text{GE2}} = 15\text{V}, R_G = 1.0\Omega, \text{Resistive}$	–	–	300	ns
	Rise Time					
Switch Times	Turn-off Delay Time	Load Switching Operation	–	–	350	ns
	Fall Time					
Diode Reverse Recovery Time	t_{rr}	$I_E = 600\text{A}, di_E/dt = -1200\text{A}/\mu\text{s}$	–	–	160	ns
Diode Reverse Recovery Charge	Q_{rr}	$I_E = 600\text{A}, di_E/dt = -1200\text{A}/\mu\text{s}$	–	1.44	–	μC

Thermal and Mechanical Characteristics, $T_j = 25^\circ\text{C}$ unless otherwise specified

Characteristics	Symbol	Test Conditions	Min.	Typ.	Max.	Units
Thermal Resistance, Junction to Case	$R_{\text{th(j-c)Q}}$	Per IGBT Module	–	–	0.08	$^\circ\text{C}/\text{W}$
Thermal Resistance, Junction to Case	$R_{\text{th(j-c)D}}$	Per FWDi Module	–	–	0.12	$^\circ\text{C}/\text{W}$
Contact Thermal Resistance	$R_{\text{th(c-f)}}$	Per Module, Thermal Grease Applied	–	0.02	–	$^\circ\text{C}/\text{W}$



Powerex, Inc., 200 Hillis Street, Youngwood, Pennsylvania 15697-1800 (724) 925-7272

CM600HU-12H
Single IGBTMOD™ U-Series Module
 600 Amperes/600 Volts

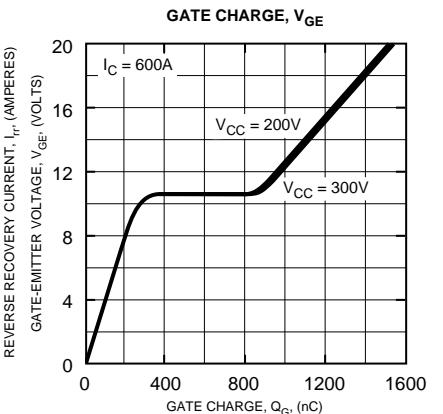
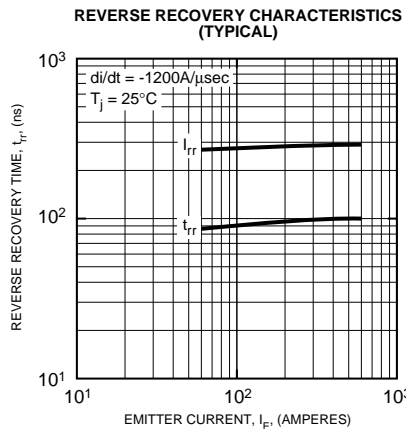
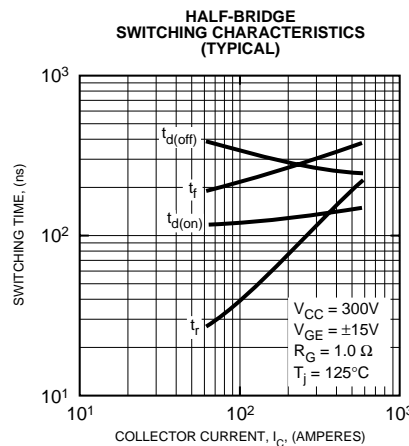
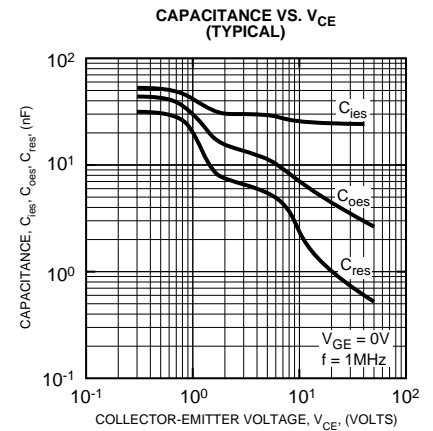
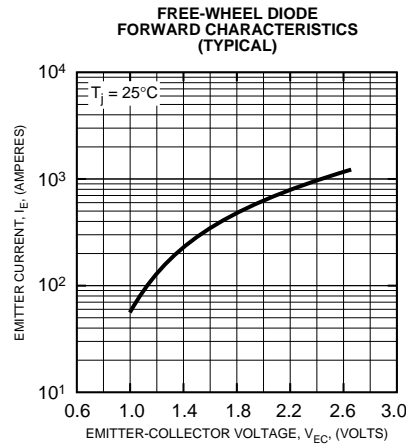
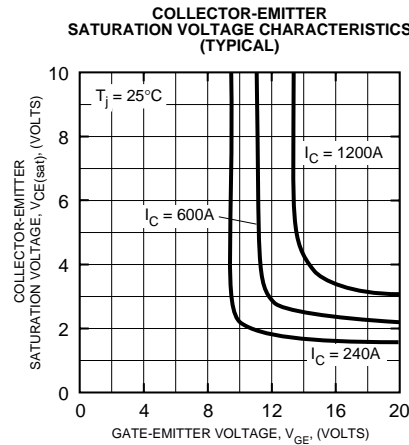
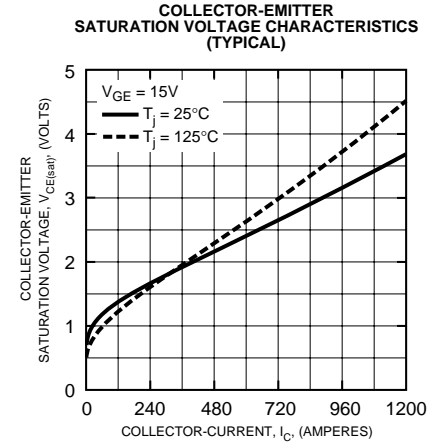
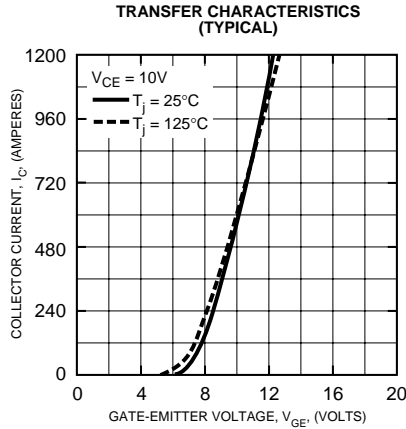
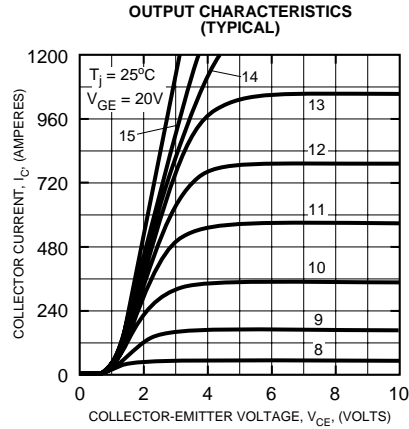

CM600HU-12H
Single IGBTMOD™ U-Series Module
 600 Amperes/600 Volts

