

Figure 1.1 Physical Photo of the ATH100K1R25

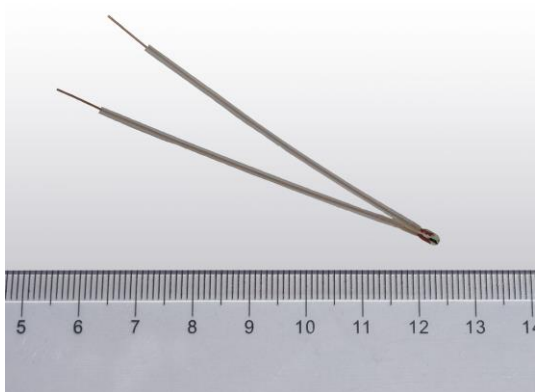

Figure 1.2 Physical Photo of the ATH100K1R25T70

MAIN FEATURES

- Glass Encapsulated for Long Term Stability & Reliability
- High Resistance Accuracy: 1%
- Small Size: $\phi 1.25\text{mm} \times 2.0\text{mm}$
- Maximum Temp. Range: -40°C to 270°C
- 100 % Lead (Pb)-free and RoHS Compliant

APPLICATION AREAS

Temperature sensing for laser diodes, optical components, etc.

DESCRIPTIONS

The ATH100K1R25 series thermistor consists of three versions, ATH100K1R25 as shown in Figure 1.1, ATH100K1R25T70 shown in Figure 1.2 and ATH100K1R25T70S. The ATH100K1R25 has bare leads coated with copper, the ATH100K1R25T70S has the leads covered by high temperature plastic tubing and sealed by epoxy, while the ATH100K1R25T70 is the non-sealed version.

The ATH100K1R25 is of a high stability and high precision glass encapsulated thermistor. Comparing with conventional epoxy encapsulated thermistors, ATH100K1R25 features much wider temperature range, especially on the high end, much better long term stability, smaller size, and shorter

response time. In addition, there are two insulation versions available, one of which comes with leads covered by plastic tubing, the ATH100K1R25T70, and the other one, the ATH100K1R25T70S, is sealed between the head and the tubing. They can work under up to 140°C temperature and the latter is of liquid resistant.

The ATH100K1R25 series thermistors can be used to sense the temperatures for laser diodes, optical components, industrial process control, etc., where high temperature sensitivity, long term stability, and/or high sensing temperature are required.

Figure 2 shows the mechanical dimensions of the ATH100K1R25T70S (ATH100K1R25 and ATH100K1R25T70 have the same dimensions). All dimension units are millimeters.

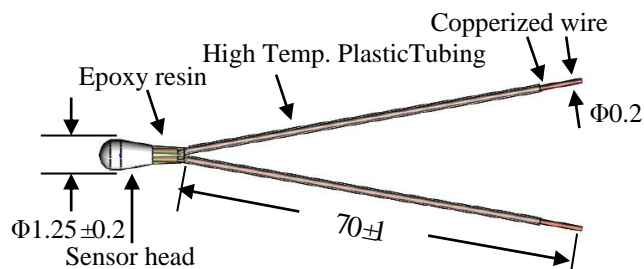

Figure 2. Side View of ATH100K1R25T70S

SPECIFICATIONS

Parameter	Value
Nominal Resistance @ 25°C	$100\text{k} \pm 1\%$
β Value @ $25^\circ\text{C}/50^\circ\text{C}$	$3950\text{k} \pm 1\%$
β Value @ $25^\circ\text{C}/85^\circ\text{C}$	$3990\text{k} \pm 1\%$
$R@25^\circ\text{C} / R@50^\circ\text{C}$	2.771
$R@25^\circ\text{C} / R@85^\circ\text{C}$	9.389
Thermistor Diameter	$1.25 \pm 0.2\text{mm}$
Thermistor Length	$2.0 \pm 0.5\text{mm}$
Lead Diameter	0.2mm
Lead Length	$70 \pm 1\text{mm}$
Dissipation Factor	$\geq 0.9\text{mW}/^\circ\text{C}$
Insulation Resistance	50M Ω
Thermal Time Constant	2.39s (in still air) 1s (in water)

APPLICATIONS

The thermistor ATH100K1R25, ATH100K1R25T70 and ATH100K1R25T70S are designed to sense solid block temperature with high stability and accuracy. The best way to mount the thermistor is to drill a hole on the object for which the temperature needs to be measured and regulated, and use thermal conductive epoxy to pot the thermistor inside the hole. The hole diameter should be between 1.4 to 1.8mm and the depth should be between 3 to 4mm. When a deeper hole is needed, drill a 2 stage hole to prevent epoxy bobbles trapped

inside the deep hole which could cause temperature measurement errors. Figure 3 shows the section view of the 2 stage hole.

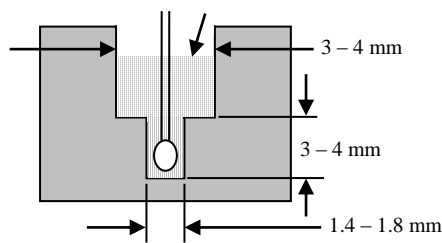

Figure 3. Section View of the 2 Stage Hole

The worst mounting result would be to have air bubbles trapped inside the thermistor mounting hole. These bubbles cause thermal sensing time delay and sensing temperature errors. To avoid the bubbles, in addition to drilling the 2 stage hole, use thin epoxy, vibrate the assembly before curing the epoxy, and cure the epoxy at high temperature, 80°C to 120°C, depending on the epoxy used and the maximum temperature the assembly components allow.

The thermistor lead wires are made of copperized alloy and there is no insulation coating on them, make sure that they do not touch each other after mounting the thermistor.

Some thermal conductive epoxies are also electrically conductive and such epoxies should not be used for mounting the thermistors, since the lead wires are conductive and the epoxy would change the thermistor resistance, thus causing temperature sensing errors.

Notice: Glass encapsulated cannot be used in water or other liquid directly.

CAUTIONS

1. Do not bend the thermistor leads at the location that is too close to the thermistors body, to avoid breaking the glass coating, as shown in Figure 4.1, Figure 4.2, and Figure 4.3 below. Only bend the leads at the location that is at least 2mm away from the thermistor body.

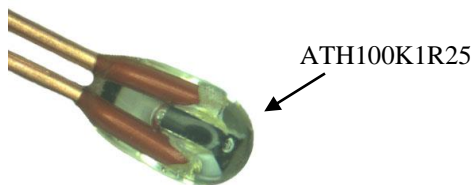

Figure 4.1. Bare Ledged Thermistor Head Photo

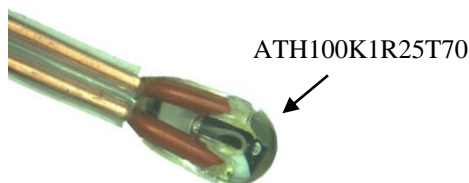

Figure 4.2. Tubing Ledged Non-sealed Thermistor Head Photo

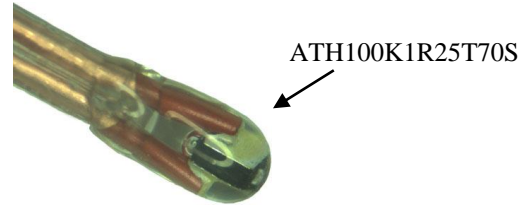

Figure 4.3. Tubing Ledged Sealed Thermistor Head Photo

2. Do not apply a large DC voltage across the thermistor in the temperature sensing circuit. The thermistor's self-heating temperature is about 1°C/mW. By injecting a 10µA current into the thermistor, it consumes 1mW and the self-heating temperature is about 1°C if the thermistor is placed in still air. Therefore, the sensing current needs to be much lower than 10µA when the thermistor is placed in the air for high accuracy applications. Injecting short current pulses into the thermistor is one of the ways to reduce the average current level on the thermistor in order to minimize the self-heating effect.
3. Handle the thermistor with care, do not use metal tools to hold the thermistor body with excessive force, otherwise, the glass body may crack, affecting its accuracy and stability.

Thermistor Resistance

Beta Value (β)

A simple approximation for the relationship between the resistance and temperature for ATH100K1R25 is to use an exponential approximation. This approximation is based on simple curve fitting to experimental data and uses two points on a curve to determine the value of β. The equation relating resistance to temperature using β is:

$$R = Ae^{\frac{\beta}{T}}$$

Where:

R = thermistor resistance at temp T,

A = constant of equation,

β = beta, the material constant,

T = thermistor temperature in °K(Kelvin);

To calculate β for any given temperature range, the following formula applies:

$$\beta = \frac{T_1 T_2 (R_2 - R_1)}{R_1 R_2 (T_2 - T_1)}$$

Where β is measured in k, R_{T1} is the resistance at T₁, while R_{T2} is the resistance at T₂.

β can be used to compare the relative steepness of ATH100K1R25 curves. However, the value of β will vary depending on the temperatures used for calculating the value. For example, to calculate β for the temperature range of 25 °C to 50 °C:

$$T1 = (25 + 273.15) \text{ K} = 298.15 \text{ K},$$

$$T2 = (50 + 273.15) \text{ K} = 323.15 \text{ K},$$

$$R_{T1} = 100 \text{ k}\Omega,$$

$$R_{T2} = 35.88 \text{ k}\Omega;$$

This value of β would be referenced as $\beta@25^\circ\text{C}/50^\circ\text{C}$, and calculated as:

$$\beta@25^\circ\text{C}/50^\circ\text{C} = \ln(100/35.88) / (1/298.15 - 1/323.15) = 3950 \text{ k};$$

By using the same formula, $\beta25^\circ\text{C}/85^\circ\text{C}$, will be:

$$\beta25^\circ\text{C}/85^\circ\text{C} = \ln(100/10.65) / (1/298.15 - 1/358.15) = 3990 \text{ k}.$$

When using the β value to compare 2 thermistors, make sure that the β values are calculated based on the same 2 temperature points.

Temperature Coefficient of Resistance (α)

Another way to characterize the R-T curve of the ATH100K1R25 is to use the slope of the resistance versus temperature (R/T) curve at one temperature. By definition, the resistance slope vs. temperature is given by:

$$\alpha = \frac{1}{R} \frac{dR}{dT};$$

Where T is the temperature in $^\circ\text{C}$ or $^\circ\text{K}$, R is the resistance at temperature T.

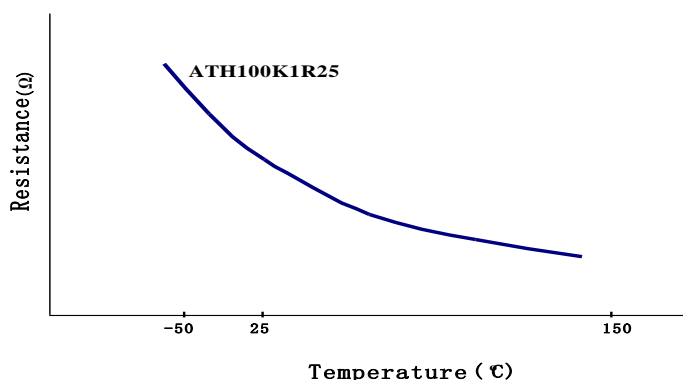

Figure 5. Resistance vs. Temperature for ATH100K1R25

As shown in Figure 5, the steepest position of the ATH100K1R25 curve is at colder temperatures.

The temperature coefficient is one method that can be used for comparing the relative steepness of the curves. It is highly recommended to compare the temperature coefficient at the same temperature because α varies widely over the operating temperature range.

Resistance Ratio (Slope)

The resistance ratio, or slope, for thermistors is defined as the ratio of the resistance at one temperature to the resistance at a higher temperature. As with resistance ratios, this method will vary depending on the temperatures used for calculating the value. This method can also be used to compare the relative steepness of two curves. There is no industry standard for the two temperatures that are used to calculate the ratio, we can select two common temperatures from the table below, for example, 25°C and 50°C , then the result of this calculation: $R@25^\circ\text{C} / R@50^\circ\text{C}$, will be:

$$R@25^\circ\text{C} / R@50^\circ\text{C} = 100/35.88 = 2.787;$$

And this calculation: $R@25^\circ\text{C}/R@85^\circ\text{C}$, will be:

$$R@25^\circ\text{C} / R@85^\circ\text{C} = 100/10.65 = 9.389.$$

Steinhart-Hart Thermistor Equation

The Steinhart-Hart Equation is an empirically derived polynomial formula which does best in describing the relationship between the resistance and the temperature of ATH100K1R25, which is much more accurate than β method. To solve for temperature when resistance is known, yields the following equation:

$$T = \frac{1}{\frac{1}{a} + \frac{b}{R} + \frac{c}{R^2}};$$

Where:

- T = temperature in $^\circ\text{K}$ (Kelvin),
- a, b and c are equation constants,
- R = resistance in Ω at temp T;

To solve for resistance when the temperature is known, the form of the equation is:

$$R = \left[\left(\frac{x}{2} + \left(\frac{x^2}{4} + \frac{\psi^3}{27} \right)^{\frac{1}{2}} \right)^{\frac{1}{3}} + \left(\frac{x}{2} - \left(\frac{x^2}{4} + \frac{\psi^3}{27} \right)^{\frac{1}{2}} \right)^{\frac{1}{3}} \right]^{-1};$$

Where:

$$x = \frac{a-1/T}{c}, \psi = \frac{b}{c}.$$

The a, b and c constants can be calculated for either a thermistor material or for individual values of the thermistors within a material type. To solve for the constants, three sets of data must be used. Normally, for a temperature range, the low end, middle end and high end values are used to calculate the constants, resulting in the best fit for the equation over the range. Using the Steinhart-Hart equation allows for accuracy as good as $\pm 0.001^\circ\text{C}$ over a 100°C temperature span.

Resistance Temperature Characteristics

Temp	Resistance	Temp	Resistance	Temp	Resistance	Temp	Resistance	Temp	Resistance
°C	kΩ	°C	kΩ	°C	kΩ	°C	kΩ	°C	kΩ
-40	3493	7	231.5	54	30.86	101	6.550	148	1.915
-39	3265	8	220.3	55	29.74	102	6.365	149	1.871
-38	3053	9	209.9	56	28.66	103	6.185	150	1.828
-37	2856	10	200.0	57	27.62	104	6.008	151	1.786
-36	2673	11	190.5	58	26.64	105	5.840	152	1.745
-35	2503	12	181.6	59	25.68	106	5.675	153	1.706
-34	2345	13	173.2	60	24.78	107	5.517	154	1.667
-33	2198	14	165.2	61	23.90	108	5.362	155	1.629
-32	2062	15	157.6	62	23.06	109	5.214	156	1.593
-31	1934	16	150.4	63	22.26	110	5.069	157	1.557
-30	1816	17	143.6	64	21.48	111	4.931	158	1.523
-29	1705	18	137.1	65	20.73	112	4.796	159	1.489
-28	1602	19	130.9	66	20.02	113	4.666	160	1.456
-27	1506	20	125.1	67	19.34	114	4.540	161	1.424
-26	1416	21	119.5	68	18.68	115	4.417	162	1.393
-25	1332	22	114.3	69	18.05	116	4.296	163	1.363
-24	1254	23	109.3	70	17.44	117	4.182	164	1.333
-23	1181	24	104.5	71	16.86	118	4.069	165	1.304
-22	1112	25	100.0	72	16.29	119	3.961	166	1.276
-21	1048	26	95.71	73	15.75	120	3.857	167	1.249
-20	988.4	27	91.61	74	15.23	121	3.755	168	1.222
-19	932.3	28	87.72	75	14.74	122	3.657	169	1.196
-18	879.6	29	84.00	76	14.25	123	3.562	170	1.171
-17	830.2	30	80.49	77	13.79	124	3.470	171	1.146
-16	784.1	31	77.11	78	13.35	125	3.381	172	1.122
-15	740.7	32	73.92	79	12.92	126	3.294	173	1.099
-14	699.9	33	70.86	80	12.50	127	3.210	174	1.076
-13	661.7	34	67.96	81	12.10	128	3.129	175	1.054
-12	625.9	35	65.19	82	11.72	129	3.050	176	1.032
-11	592.0	36	62.55	83	11.35	130	2.973	177	1.011
-10	560.4	37	60.01	84	11.00	131	2.898	178	0.9870
-9	530.5	38	57.61	85	10.65	132	2.826	179	0.9671
-8	502.4	39	55.32	86	10.32	133	2.756	180	0.9472
-7	476.2	40	53.12	87	10.00	134	2.688	181	0.9282
-6	451.3	41	51.02	88	9.698	135	2.622	182	0.9093
-5	428.0	42	49.02	89	9.401	136	2.557	183	0.8913
-4	405.8	43	47.12	90	9.115	137	2.495	184	0.8734
-3	385.1	44	45.28	91	8.838	138	2.434	185	0.8564
-2	365.4	45	43.54	92	8.573	139	2.376	186	0.8395
-1	347.1	46	41.88	93	8.317	140	2.318	187	0.8225
0	329.5	47	40.28	94	8.068	141	2.263	188	0.8066
1	313.0	48	38.74	95	7.827	142	2.209	189	0.7906
2	297.5	49	37.28	96	7.597	143	2.157	190	0.7757
3	282.7	50	35.88	97	7.374	144	2.106	191	0.7607
4	268.8	51	34.56	98	7.158	145	2.056	192	0.7458
5	255.6	52	33.26	99	6.949	146	2.008	193	0.7308
6	243.2	53	32.04	100	6.749	147	1.961	194	0.7168



Temp	Resistance	Temp	Resistance	Temp	Resistance	Temp	Resistance	Temp	Resistance
°C	kΩ	°C	kΩ	°C	kΩ	°C	kΩ	°C	kΩ
195	0.7039	211	0.5224	226	0.4004	241	0.3126	256	0.2469
196	0.6899	212	0.5125	227	0.3944	242	0.3076	257	0.2429
197	0.6770	213	0.5035	228	0.3874	243	0.3026	258	0.2398
198	0.6640	214	0.4945	229	0.3805	244	0.2977	259	0.2359
199	0.6520	215	0.4851	230	0.3745	245	0.2927	260	0.2329
200	0.6391	216	0.4771	231	0.3685	246	0.2887	261	0.2290
201	0.6281	217	0.4681	232	0.3625	247	0.2837	262	0.2263
202	0.6161	218	0.4602	233	0.3566	248	0.2787	263	0.2220
203	0.6042	219	0.4522	234	0.3506	249	0.2748	264	0.2190
204	0.5932	220	0.4442	235	0.3446	250	0.2708	265	0.2160
205	0.5822	221	0.4372	236	0.3386	251	0.2668	266	0.2130
206	0.5723	222	0.4293	237	0.3337	252	0.2626	267	0.2091
207	0.5613	223	0.4223	238	0.3277	253	0.2588	268	0.2060
208	0.5513	224	0.4143	239	0.3227	254	0.2548	269	0.2031
209	0.5414	225	0.4074	240	0.3176	255	0.2509	270	0.2001
210	0.5314								



AGING TEST DATA

I. High Temp. Action

Purpose	Test the durability of the thermistor in load voltage circuit and 120 °C																				
Method	Connect the circuit according to the figure below. The thermistor works in -30 °C for 240 hrs. During this process, measure the voltage of the two ends of thermistor every 24 hrs and then calculate the resistance value based on differential pressure principle. Compare the changing rate of this point before and after the test.																				
Test data																					
No.	0h	24h	48h	72h	96h	120h	Change rate					144h	168h	192h	216h	240h	Change rate				
Temp. Field	Mv						δ1	δ2	δ3	δ4	δ5						δ5	δ5	δ7	δ8	δ5
1	255	256	257	257	258	258	0.39	0.78	0.78	1.18	1.18	258	258	259	258	258	1.18	1.18	1.57	1.18	1.18
2	254	256	257	257	257	257	0.79	1.18	1.18	1.18	1.18	258	258	258	258	258	1.57	1.57	1.57	1.57	1.57
3	258	260	261	261	261	261	0.78	1.16	1.16	1.16	1.16	261	261	261	261	261	1.16	1.16	1.16	1.16	1.16
4	257	259	261	260	261	261	0.78	1.56	1.17	1.56	1.56	261	261	261	261	261	1.56	1.56	1.56	1.56	1.56
5	254	255	256	256	257	257	0.39	0.79	0.79	1.18	1.18	257	257	258	258	258	1.18	1.18	1.57	1.57	1.57
6	253	255	256	256	256	256	0.79	1.19	1.19	1.19	1.19	256	257	256	257	257	1.19	1.58	1.19	1.58	1.58
7	256	256	257	257	258	258	0.00	0.39	0.39	0.78	0.78	258	259	259	259	259	0.78	1.17	1.17	1.17	1.17
8	259	259	260	261	261	262	0.00	0.39	0.77	0.77	1.16	262	262	263	263	263	1.16	1.16	1.54	1.54	1.54
9	258	259	259	260	260	260	0.39	0.39	0.78	0.78	0.78	260	260	260	260	260	0.78	0.78	0.78	0.78	0.78
10	255	257	259	258	258	258	0.78	1.57	1.18	1.18	1.18	258	258	258	258	258	1.18	1.18	1.18	1.18	1.18
11	254	256	256	256	257	257	0.79	0.79	0.79	1.18	1.18	257	257	257	257	257	1.18	1.18	1.18	1.18	1.18
12	257	258	259	259	259	259	0.39	0.78	0.78	0.78	0.78	259	259	259	259	259	0.78	0.78	0.78	0.78	0.78
13	256	258	258	258	259	259	0.78	0.78	0.78	1.17	1.17	259	259	259	259	259	1.17	1.17	1.17	1.17	1.17
14	258	258	259	259	260	260	0.00	0.39	0.39	0.78	0.78	260	260	260	260	260	0.78	0.78	0.78	0.78	0.78



No.	0h	24h	48h	72h	96h	120h	Change rate					144h	168h	192h	216h	240h	Change rate				
Temp. Field	Mv						δ1	δ2	δ3	δ4	δ5						δ5	δ5	δ7	δ8	δ5
15	258	260	261	261	260	261	0.78	1.16	1.16	0.78	1.16	261	261	261	261	261	1.16	1.16	1.16	1.16	1.16
16	256	257	257	258	258	258	0.39	0.39	0.78	0.78	0.78	258	258	258	258	258	0.78	0.78	0.78	0.78	0.78
17	257	259	260	260	260	259	0.78	1.17	1.17	1.17	0.78	259	259	260	259	259	0.78	0.78	1.17	0.78	0.78
18	256	258	259	259	260	260	0.78	1.17	1.17	1.56	1.56	260	260	260	260	260	1.56	1.56	1.56	1.56	1.56
19	257	259	258	259	259	259	0.78	0.39	0.78	0.78	0.78	259	259	260	260	260	0.78	0.78	1.17	1.17	1.17
20	255	256	256	256	257	257	0.39	0.39	0.39	0.78	0.78	257	257	258	258	258	0.78	0.78	1.18	1.18	1.18

Note:

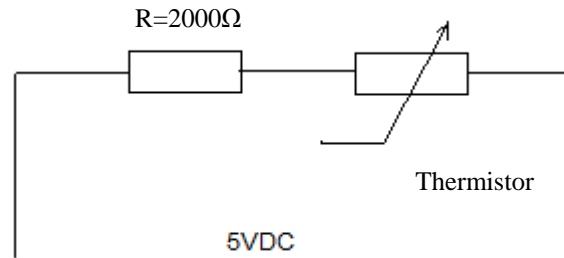



II. Low Temp. Action

Purpose	Test the durability of the thermistor in load voltage circuit and -30 °C																				
Method	Connect the circuit according to the figure below. The thermistor works in -30 °C for 192 hrs. During this process, measure the voltage of the two ends of thermistor every 24 hrs and then calculate the resistance value based on differential pressure principle. Compare the changing rate of this point before and after the test.																				
Test data																					
No.	0h	24h	48h	72h	96h	120h	Change rate					144h	168h	192h	216h	240h	Change rate				
Temp. Field	V	V	V	V	V	V	δ1	δ2	δ3	δ4	δ5	V	V	V			δ1	δ2	δ3	δ4	δ5
1	4.603	4.603	4.603	4.604	4.604	4.604	0.00	0.00	0.02	0.02	0.02	4.605	4.605	4.605			0.04	0.04	0.04		
2	4.600	4.599	4.600	4.600	4.600	4.600	-0.02	0.00	0.00	0.00	0.00	4.602	4.602	4.602			0.04	0.04	0.04		
3	4.589	4.589	4.590	4.590	4.590	4.590	0.00	0.02	0.02	0.02	0.02	4.591	4.591	4.592			0.04	0.04	0.07		
4	4.608	4.608	4.608	4.609	4.609	4.610	0.00	0.00	0.02	0.02	0.04	4.610	4.610	4.611			0.04	0.04	0.07		
5	4.616	4.617	4.617	4.618	4.618	4.619	0.02	0.02	0.04	0.04	0.06	4.619	4.620	4.620			0.06	0.09	0.09		
6	4.592	4.592	4.592	4.592	4.592	4.593	0.00	0.00	0.00	0.00	0.02	4.593	4.593	4.593			0.02	0.02	0.02		
7	4.601	4.601	4.601	4.602	4.602	4.602	0.00	0.00	0.02	0.02	0.02	4.603	4.603	4.603			0.04	0.04	0.04		
8	4.592	4.592	4.592	4.593	4.593	4.593	0.00	0.00	0.02	0.02	0.02	4.593	4.594	4.594			0.02	0.04	0.04		
9	4.608	4.609	4.609	4.609	4.609	4.610	0.02	0.02	0.02	0.02	0.04	4.610	4.611	4.611			0.04	0.07	0.07		
10	4.609	4.609	4.609	4.610	4.610	4.610	0.00	0.00	0.02	0.02	0.02	4.610	4.611	4.611			0.02	0.04	0.04		
11	4.608	4.608	4.608	4.609	4.609	4.609	0.00	0.00	0.02	0.02	0.02	4.609	4.610	4.609			0.02	0.04	0.02		
12	4.588	4.587	4.588	4.588	4.588	4.589	-0.02	0.00	0.00	0.00	0.02	4.589	4.589	4.589			0.02	0.02	0.02		
13	4.579	4.579	4.579	4.579	4.579	4.580	0.00	0.00	0.00	0.00	0.02	4.580	4.581	4.580			0.02	0.04	0.02		
14	4.601	4.601	4.601	4.601	4.601	4.602	0.00	0.00	0.00	0.00	0.02	4.602	4.602	4.602			0.02	0.02	0.02		



No.	0h	24h	48h	72h	96h	120h	Change rate					144h	168h	192h	216h	240h	Change rate				
Temp. Field	V	V	V	V	V	V	$\delta 1$	$\delta 2$	$\delta 3$	$\delta 4$	$\delta 5$	V	V	V			$\delta 1$	$\delta 2$	$\delta 3$	$\delta 4$	$\delta 5$
15	4.608	4.609	4.609	4.609	4.609	4.610	0.02	0.02	0.02	0.02	0.04	4.611	4.611	4.611			0.07	0.07	0.07		
16	4.611	4.610	4.611	4.611	4.611	4.612	-0.02	0.00	0.00	0.00	0.02	4.612	4.613	4.613			0.02	0.04	0.04		
17	4.595	4.595	4.596	4.596	4.596	4.596	0.00	0.02	0.02	0.02	0.02	4.596	4.596	4.597			0.02	0.02	0.04		
18	4.602	4.602	4.602	4.603	4.603	4.603	0.00	0.00	0.02	0.02	0.02	4.603	4.603	4.604			0.02	0.02	0.04		
19	4.606	4.606	4.606	4.607	4.607	4.607	0.00	0.00	0.02	0.02	0.02	4.607	4.607	4.607			0.02	0.02	0.02		
20	4.593	4.594	4.594	4.594	4.594	4.594	0.02	0.02	0.02	0.02	0.02	4.595	4.594	4.595			0.04	0.02	0.04		

Note:

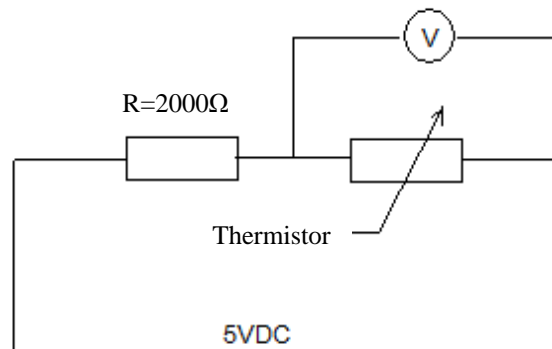



III. High Temp. Storage

Purpose	Test the high temperature resistance performance of the thermistor												
Method	Place the thermistor in high temp. (+100 °C) for 1000 hrs; Measure the electrical property change before and after the test.												
Test data													
No.	0h	24h	336h	500h	800h	1000h	Change rate					B25/50	Change rate δ 6
							δ1	δ2	δ3	δ4	δ5		
Temp. Field							δ1	δ2	δ3	δ4	δ5		
1	9.867	9.869	9.888	9.897	9.9	9.909	0.02	0.21	0.30	0.33	0.43	3467	
2	9.875	9.879	9.898	9.907	9.915	9.916	0.04	0.23	0.32	0.41	0.42	3466	
3	9.877	9.879	9.882	9.888	9.902	9.903	0.02	0.05	0.11	0.25	0.26	3463	
4	9.869	9.872	9.884	9.891	9.9	9.906	0.03	0.15	0.22	0.31	0.37	3463	
5	9.809	9.811	9.82	9.823	9.844	9.849	0.02	0.11	0.14	0.36	0.41	3466	
6	9.887	9.889	9.898	9.919	9.923	9.928	0.02	0.11	0.32	0.36	0.41	3467	
7	9.861	9.862	9.883	9.891	9.892	9.903	0.01	0.22	0.30	0.31	0.43	3463	
8	9.827	9.829	9.838	9.862	9.872	9.869	0.02	0.11	0.36	0.46	0.43	3465	
9	9.792	9.793	9.803	9.822	9.824	9.838	0.01	0.11	0.31	0.33	0.47	3465	
10	9.777	9.781	9.790	9.797	9.803	9.806	0.04	0.13	0.20	0.27	0.30	3465	
11	9.802	9.804	9.813	9.83	9.835	9.841	0.02	0.11	0.29	0.34	0.40	3463	
12	9.8	9.802	9.816	9.816	9.818	9.822	0.02	0.16	0.16	0.18	0.23	3467	
13	9.849	9.853	9.86	9.867	9.874	9.88	0.04	0.11	0.18	0.25	0.31	3463	
14	9.851	9.853	9.866	9.881	9.896	9.897	0.02	0.15	0.30	0.46	0.47	3464	
15	9.844	9.846	9.855	9.875	9.885	9.886	0.02	0.11	0.31	0.42	0.43	3466	
16	9.849	9.849	9.86	9.879	9.879	9.886	0.00	0.11	0.30	0.30	0.38	3468	
17	9.867	9.868	9.876	9.889	9.896	9.909	0.01	0.09	0.22	0.29	0.43	3463	
18	9.873	9.874	9.886	9.892	9.903	9.915	0.01	0.13	0.19	0.30	0.43	3468	
19	9.87	9.872	9.876	9.887	9.895	9.899	0.02	0.06	0.17	0.25	0.29	3464	
20	9.875	9.879	9.886	9.912	9.922	9.924	0.04	0.11	0.37	0.48	0.50	3465	



IV. Low Temp. Storage

Purpose	Test the stability of the thermistor in low temperature												
Method	Put the thermistor in low temperature environment (-40 °C) for 1000 hrs; Measure the electrical property change before and after the test.												
Test data													
No.	0h	24h	336h	500h	800h	1000h	Change rate					B25/50	Change rate
Temp. Field							$\delta 1$	$\delta 2$	$\delta 3$	$\delta 4$	$\delta 5$		$\delta 6$
1	9.896	9.895	9.895	9.896	9.897	9.897	-0.01	-0.01	0.00	0.01	0.01	3466	0.00
2	10.052	10.052	10.053	10.052	10.054	10.052	0.00	0.01	0.00	0.02	0.00	3463	0.00
3	9.829	9.829	9.829	9.829	9.829	9.829	0.00	0.00	0.00	0.00	0.00	3463	0.01
4	9.955	9.955	9.956	9.956	9.956	9.956	0.00	0.01	0.01	0.01	0.01	3465	0.00
5	10.032	10.033	10.032	10.035	10.035	10.035	0.01	0.00	0.03	0.03	0.03	3464	0.00
6	9.973	9.974	9.973	9.974	9.973	9.973	0.01	0.00	0.01	0.00	0.00	3464	0.00
7	9.832	9.833	9.834	9.833	9.8342	9.835	0.01	0.02	0.01	0.02	0.03	3465	0.01
8	9.911	9.912	9.911	9.912	9.912	9.912	0.01	0.00	0.01	0.01	0.01	3466	0.01
9	9.897	9.899	9.899	9.900	9.900	9.900	0.02	0.02	0.03	0.03	0.03	3465	0.01
10	9.886	9.887	9.886	9.886	9.887	9.887	0.01	0.00	0.00	0.01	0.01	3465	0.00
11	9.943	9.944	9.943	9.944	9.943	9.944	0.01	0.00	0.01	0.00	0.01	3466	0.00
12	9.812	9.813	9.813	9.812	9.813	9.812	0.01	0.01	0.00	0.01	0.00	3465	0.00
13	10.003	10.004	10.003	10.003	10.003	10.004	0.01	0.00	0.00	0.00	0.01	3464	0.00
14	9.882	9.883	9.883	9.883	9.882	9.882	0.01	0.01	0.01	0.00	0.00	3466	0.00
15	10.019	10.02	10.019	10.02	10.02	10.019	0.01	0.00	0.01	0.01	0.00	3465	0.01
16	9.935	9.936	9.937	9.938	9.938	9.939	0.01	0.02	0.03	0.03	0.04	3466	0.01
17	9.944	9.945	9.945	9.944	9.945	9.945	0.01	0.01	0.00	0.01	0.01	3465	0.01
18	9.879	9.88	9.881	9.88	9.881	9.881	0.01	0.02	0.01	0.02	0.02	3466	0.00
19	9.983	9.983	9.984	9.983	9.983	9.984	0.00	0.01	0.00	0.00	0.01	3466	0.00
20	9.909	9.91	9.909	9.91	9.911	9.91	0.01	0.00	0.01	0.02	0.01	3463	0.00



V. High Temp. & High Humidity

Purpose		Test the durability of the thermistor in high temp. and high humidity condition											
Method		Put it in an environment of constant humidity RH=95% and temp.T=40 °C. Measure the electrical performance change after some hours.											
Test data													
No.	0h	24h	336h	500h	800h	1000h	Change rate					B25/50	Change rate
							$\delta 1$	$\delta 2$	$\delta 3$	$\delta 4$	$\delta 5$		
Temp. Field							$\delta 1$	$\delta 2$	$\delta 3$	$\delta 4$	$\delta 5$		$\delta 6$
1	10.011	10.013	10.019	10.022	10.024	10.027	0.02	0.08	0.11	0.13	0.16	3462	0.01
2	10.003	10.003	10.01	10.015	10.015	10.018	0.00	0.07	0.12	0.12	0.15	3466	0.00
3	9.929	9.929	9.932	9.937	9.939	9.94	0.00	0.03	0.08	0.10	0.11	3463	0.01
4	9.961	9.965	9.966	9.969	9.97	9.971	0.04	0.05	0.08	0.09	0.10	3464	-0.01
5	10.091	10.091	10.093	10.096	10.096	10.097	0.00	0.02	0.05	0.05	0.06	3466	0.00
6	10.058	10.057	10.057	10.069	10.069	10.072	-0.01	-0.01	0.11	0.11	0.14	3466	0.00
7	9.932	9.933	9.936	9.94	9.944	9.944	0.01	0.04	0.08	0.12	0.12	3465	0.00
8	9.992	9.993	9.994	9.997	10.004	10.004	0.01	0.02	0.05	0.12	0.12	3463	0.01
9	9.967	9.967	9.972	9.973	9.973	9.976	0.00	0.05	0.06	0.06	0.09	3464	0.01
10	10.08	10.082	10.086	10.086	10.089	10.092	0.02	0.06	0.06	0.09	0.12	3463	0.02
11	9.933	9.933	9.937	9.939	9.948	9.95	0.00	0.04	0.06	0.15	0.17	3466	0.01
12	9.912	9.913	9.917	9.922	9.923	9.924	0.01	0.05	0.10	0.11	0.12	3463	0.00
13	9.943	9.944	9.948	9.948	9.952	9.952	0.01	0.05	0.05	0.09	0.09	3462	-0.01
14	9.965	9.964	9.968	9.968	9.973	9.973	-0.01	0.03	0.03	0.08	0.08	3466	0.00
15	10.049	10.049	10.055	10.056	10.056	10.055	0.00	0.06	0.07	0.07	0.06	3465	0.00
16	9.907	9.906	9.911	9.913	9.919	9.92	-0.01	0.04	0.06	0.12	0.13	3466	0.01
17	10.007	10.007	10.011	10.012	10.017	10.019	0.00	0.04	0.05	0.10	0.12	3463	0.01
18	10.052	10.05	10.056	10.057	10.058	10.061	-0.02	0.04	0.05	0.06	0.09	3464	-0.01
19	9.983	9.983	9.987	9.99	9.993	9.994	0.00	0.04	0.07	0.10	0.11	3464	0.00
20	10.077	10.077	10.082	10.083	10.083	10.084	0.00	0.05	0.06	0.06	0.07	3463	0.01



VI. Load Test

Purpose	Test the durability of the thermistor in load voltage circuit												
Method	Connect the circuit according to the figure below. Circulate 500 times in dry cold and hot environment. Circulating method: one circle is that put it in dry hot environment (+100 °C) for 30 min and take out to put in room temperature for 30 min, and then dry low temp. (-30 °C) environment for 30 min, and then dry hot environment (+100 °C) for 30 min.												
Test data													
No.	0	50 times	100 times	200 times	300 times	500 times	Change rate					B25/50	Change rate
Temp. Field							δ1	δ2	δ3	δ4	δ5		δ 6
1	9.882	9.886	9.891	9.906	9.918	9.923	0.04	0.09	0.24	0.36	0.41	3463	
2	9.977	9.978	9.983	10.002	10.01	10.017	0.01	0.06	0.25	0.33	0.40	3466	
3	9.701	9.704	9.708	9.73	9.735	9.739	0.03	0.07	0.30	0.35	0.39	3466	
4	9.725	9.731	9.736	9.747	9.761	9.761	0.06	0.11	0.23	0.37	0.37	3464	
5	9.867	9.869	9.876	9.886	9.901	9.906	0.02	0.09	0.19	0.34	0.40	3466	
6	9.784	9.786	9.788	9.808	9.828	9.831	0.02	0.04	0.25	0.45	0.48	3463	
7	9.746	9.750	9.753	9.766	9.772	9.778	0.04	0.07	0.21	0.27	0.33	3465	
8	9.825	9.826	9.829	9.846	9.848	9.853	0.01	0.04	0.21	0.23	0.28	3464	
9	9.725	9.726	9.729	9.749	9.762	9.767	0.01	0.04	0.25	0.38	0.43	3464	
10	9.777	9.777	9.783	9.801	9.821	9.824	0.00	0.06	0.25	0.45	0.48	3464	
11	9.742	9.747	9.753	9.775	9.779	9.784	0.05	0.11	0.34	0.38	0.43	3465	
12	9.89	9.894	9.894	9.908	9.916	9.921	0.04	0.04	0.18	0.26	0.31	3466	
13	9.843	9.846	9.849	9.868	9.873	9.878	0.03	0.06	0.25	0.30	0.36	3466	
14	9.769	9.770	9.773	9.789	9.792	9.798	0.01	0.04	0.20	0.24	0.30	3463	
15	9.775	9.779	9.784	9.789	9.792	9.797	0.04	0.09	0.14	0.18	0.23	3463	
16	9.829	9.830	9.833	9.838	9.862	9.864	0.01	0.04	0.09	0.34	0.35	3464	
17	9.823	9.825	9.829	9.847	9.842	9.847	0.02	0.06	0.24	0.19	0.24	3465	
18	9.767	9.769	9.774	9.796	9.796	9.798	0.02	0.07	0.30	0.30	0.32	3464	
19	9.809	9.813	9.819	9.829	9.829	9.831	0.04	0.10	0.20	0.20	0.22	3465	
20	9.811	9.812	9.815	9.828	9.844	9.849	0.01	0.04	0.17	0.34	0.39	3466	



Note:

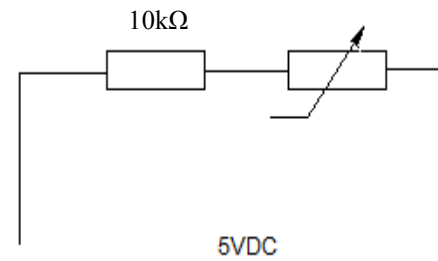
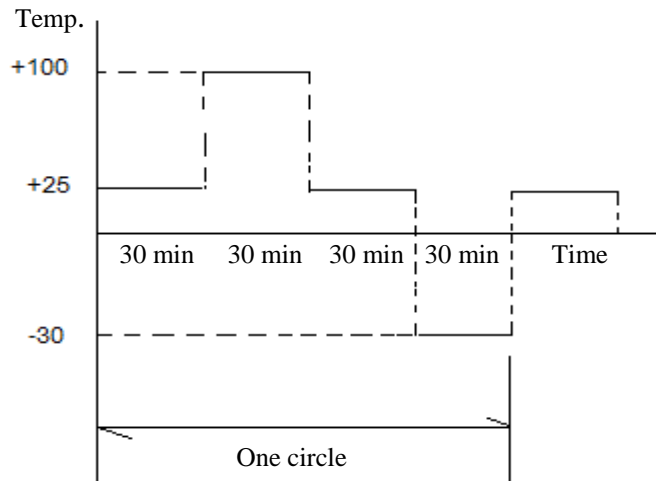



VII. Cold and Hot Impact

Purpose	Test the cold and hot impact performance of the thermistor												
Method	Connect the circuit according to the figure below, and electrical property change rate. Circulate 500 times in dry cold and hot environment. Circulating method: one circle is that put it in dry hot environment (+100 °C) for 10 min and take out to put in room temperature for 5 min, and then dry low temp. (-30 °C) environment for 10 min, and then dry hot environment (+100 °C) for 10 min.												
Test data													
No.	0h	24h	336h	500h	800h	1000h	Change rate					B25/50	Change rate
Temp. Field							δ1	δ2	δ3	δ4	δ5		δ 6
1	10.118	10.129	10.173	10.177	10.18	10.184	0.11	0.54	0.58	0.61	0.65	3463	
2	10.182	10.193	10.221	10.225	10.229	10.23	0.11	0.38	0.42	0.46	0.47	3466	
3	10.157	10.1886	10.2176	10.2216	10.2256	10.2266	0.31	0.60	0.64	0.68	0.69	3466	
4	10.2	10.2016	10.2256	10.2306	10.2336	10.2376	0.02	0.25	0.30	0.33	0.37	3464	
5	10.166	10.1766	10.2106	10.2116	10.2126	10.2146	0.10	0.44	0.45	0.46	0.48	3466	
6	10.192	10.206	10.2294	10.2334	10.2364	10.2404	0.14	0.37	0.41	0.44	0.47	3463	
7	10.112	10.123	10.167	10.171	10.172	10.175	0.11	0.54	0.58	0.59	0.62	3465	
8	10.154	10.166	10.1834	10.1854	10.1854	10.1894	0.12	0.29	0.31	0.31	0.35	3464	
9	10.143	10.143	10.177	10.181	10.184	10.19	0.00	0.34	0.37	0.40	0.46	3464	
10	10.218	10.2276	10.2516				0.09						
11	10.221	10.2256	10.2596	10.2636	10.2666	10.2706	0.05	0.38	0.42	0.45	0.49	3465	
12	10.173	10.189	10.233	10.237	10.238	10.241	0.16	0.59	0.63	0.64	0.67	3466	
13	10.167	10.178	10.222	10.223	10.224	10.228	0.11	0.54	0.55	0.56	0.60	3466	
14	10.175	10.193	10.224	10.228	10.231	10.231	0.18	0.48	0.52	0.55	0.55	3463	
15	10.177	10.197	10.241	10.241	10.242	10.243	0.20	0.63	0.63	0.64	0.65	3463	
16	10.128	10.138	10.152	10.156	10.159	10.163	0.10	0.24	0.28	0.31	0.35	3464	
17	10.11	10.116	10.129	10.134	10.137	10.139	0.06	0.19	0.24	0.27	0.29	3465	
18	10.221	10.2346	10.2786	10.2826	10.2826	10.2836	0.13	0.56	0.60	0.60	0.61	3464	
19	10.192	10.1936	10.2476	10.2496	10.2526	10.2566	0.02	0.55	0.57	0.59	0.63	3465	
20	10.137	10.1556	10.1896	10.1936	10.1956	10.1986	0.18	0.52	0.56	0.58	0.61	3466	



Note:

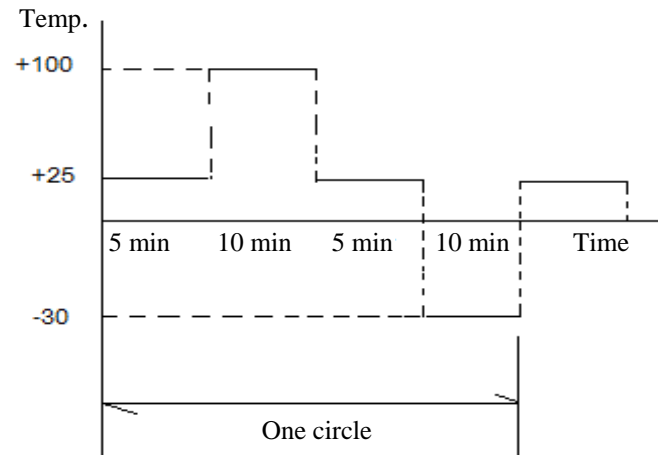



VIII. Durability Test

Purpose	Test the durability of the thermistor with load												
Method	Connect the circuit according to the figure below, in an environment of humidity RH=95% and temp.T=40 °C. Measure the electrical performance change after 10000 hrs.												
Test data													
No.	0h	500h	2000h	5000h	8000h	10000h	Change rate					B25/50	Change rate
Temp. Field							δ1	δ2	δ3	δ4	δ5		δ 6
1	9.934	9.937	9.979	10.028	10.058	10.06	0.03	0.45	0.95	1.25	1.27	3460	
2	9.925	9.927	9.98	10.015	10.025	10.027	0.02	0.55	0.91	1.01	1.03	3462	
3	9.989	9.995	10.034	10.099	10.121	10.121	0.06	0.45	1.10	1.32	1.32	3463	
4	9.896	9.899	9.931	10.036	10.058	10.059	0.03	0.35	1.41	1.64	1.65	3461	
5	9.901	9.906	9.946	10.011	10.041	10.043	0.05	0.45	1.11	1.41	1.43	3460	
6	9.944	9.954	9.969	10.044	10.074	10.078	0.10	0.25	1.01	1.31	1.35	3461	
7	9.967	9.974	10.012	10.047	10.066	10.068	0.07	0.45	0.80	0.99	1.01	3461	
8	9.878	9.881	9.943	9.97	10	10.002	0.03	0.66	0.93	1.24	1.26	3466	
9	9.911	9.913	9.964	10.012	10.032	10.035	0.02	0.53	1.02	1.22	1.25	3461	
10	9.971	9.981	10.016	10.068	10.098	10.099	0.10	0.45	0.97	1.27	1.28	3463	
11	9.991	9.999	10.063	10.101	10.131	10.133	0.08	0.72	1.10	1.40	1.42	3460	
12	9.949	9.952	9.994	10.05	10.074	10.076	0.03	0.45	1.02	1.26	1.28	3461	
13	9.917	9.928	9.982	10.004	10.034	10.036	0.11	0.66	0.88	1.18	1.20	3460	
14	9.926	9.929	9.971	10.009	10.019	10.021	0.03	0.45	0.84	0.94	0.96	3461	
15	9.951	9.952	9.996	10.042	10.069	10.074	0.01	0.45	0.91	1.19	1.24	3461	
16	9.945	9.948	9.981	10.043	10.073	10.075	0.03	0.36	0.99	1.29	1.31	3461	
17	9.962	9.974	10.007	10.072	10.092	10.096	0.12	0.45	1.10	1.30	1.35	3460	
18	9.987	9.990	10.032	10.072	10.102	10.104	0.03	0.45	0.85	1.15	1.17	3462	
19	9.879	9.887	9.914	9.979	10	10.004	0.08	0.35	1.01	1.22	1.27	3464	
20	9.928	9.933	9.953	10.019	10.036	10.038	0.05	0.25	0.92	1.09	1.11	3461	



Note:

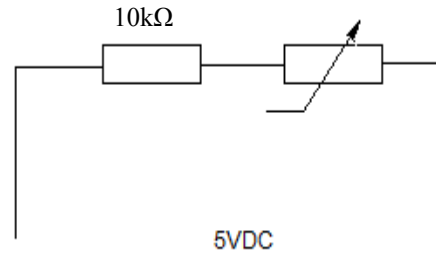



IX. Vibration Test

Purpose	Test the electrical performance stability of the thermistor in vibration temperature												
Method	Vibrating method: 1. Frequency: 50~550HZ; 2. Accelerated speed: 38g; 3. Vibration direction: X-Y-Z axis; 4. Vibration time: 25 hrs for each axis												
Test data													
No.	0h	24h	336h	500h	800h	1000h	Change rate					B25/50	Change rate
Temp. Field							δ1	δ2	δ3	δ4	δ5		δ 6
1	10.223	10.244					0.21						
2	10.241	10.251					0.10						
3	10.332	10.337					0.05						
4	10.254	10.278					0.23						
5	10.273	10.292					0.18						
6	10.262	10.275					0.13						
7	10.2	10.203					0.03						
8	10.291	10.298					0.07						
9	10.235	10.255					0.20						
10	10.311	10.323					0.12						
11	10.279	10.29					0.11						
12	10.255	10.283					0.27						
13	10.304	10.322					0.17						
14	10.216	10.225					0.09						
15	10.298	10.324					0.25						
16	10.338	10.341					0.03						
17	10.229	10.24					0.11						
18	10.251	10.264					0.13						
19	10.283	10.306					0.22						
20	10.357	10.365					0.08						



NOTICE

1. ATI reserves the right to make changes to its products or to discontinue any product or service without notice, and advise customers to obtain the latest version of relevant information to verify, before placing orders, that information being relied on is current and complete.
2. All products are sold subject to the terms and conditions of sale supplied at the time of order acknowledgment, including those pertaining to warranty, patent infringement, and limitation of liability. Testing and other quality control techniques are utilized to the extent ATI deems necessary to support this warranty. Specific testing of all parameters of each device is not necessarily performed, except those mandated by government requirements.
3. Customers are responsible for their applications using ATI components. In order to minimize risks associated with the customers' applications, adequate design and operating safeguards must be provided by the customers to minimize inherent or procedural hazards. ATI assumes no liability for applications assistance or customer product design.
4. ATI does not warrant or represent that any license, either express or implied, is granted under any patent right, copyright, mask work right, or other intellectual property right of ATI covering or relating to any combination, machine, or process in which such products or services might be or are used. ATI's publication of information regarding any third party's products or services does not constitute ATI's approval, warranty or endorsement thereof.
5. IP (Intellectual Property) Ownership: ATI retains the ownership of full rights for special technologies and/or techniques embedded in its products, the designs for mechanics, optics, plus all modifications, improvements, and inventions made by ATI for its products and/or projects.