

## HEIDI-W2

~45° wide beam

### SPECIFICATION:

Dimensions	Ø 21.6 mm
Height	12 mm
Fastening	tape, pin
ROHS compliant	yes ⓘ

### MATERIALS:

Component	Type	Material	Colour	Finish
HEIDI-W2	Single lens	PMMA	clear	
HEIDI-TAPE	Tape	Acrylic foam	black	

### ORDERING INFORMATION:

Component		Qty in box	MOQ	MPQ	Box weight (kg)
CA12079_HEIDI-W2	Single lens	3264	204	204	11.1
» Box size: 480 x 280 x 300 mm					



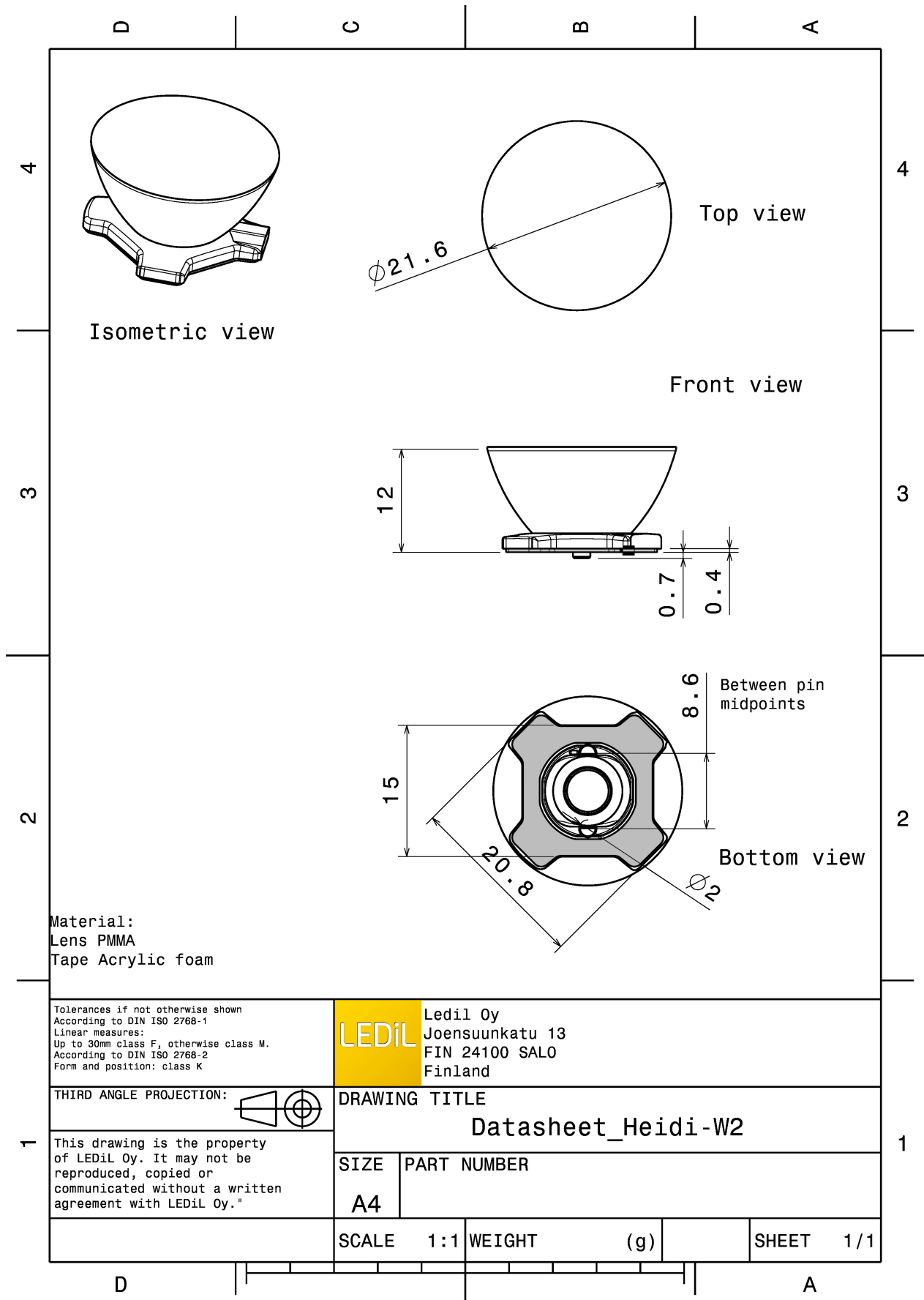

See also our general installation guide: [www.ledil.com/installation\\_guide](http://www.ledil.com/installation_guide)

### OPTICAL RESULTS (MEASURED):

#### CREE → LED

LED XB-D  
 FWHM / FWTM 46.0°  
 Efficiency 76 %  
 Peak intensity 1 cd/lm  
 LEDs/each optic 1  
 Light colour White  
 Required components:

#### CREE → LED

LED XB-H  
 FWHM / FWTM 45.0° / 76.0°  
 Efficiency 80 %  
 Peak intensity 1.2 cd/lm  
 LEDs/each optic 1  
 Light colour White  
 Required components:

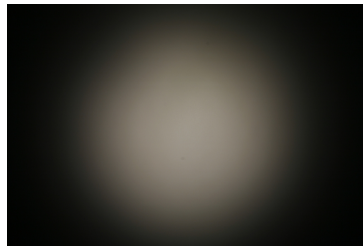

#### CREE → LED

LED XHP35 HD  
 FWHM / FWTM 46.0° / 80.0°  
 Efficiency 81 %  
 Peak intensity 1.3 cd/lm  
 LEDs/each optic 1  
 Light colour White  
 Required components:

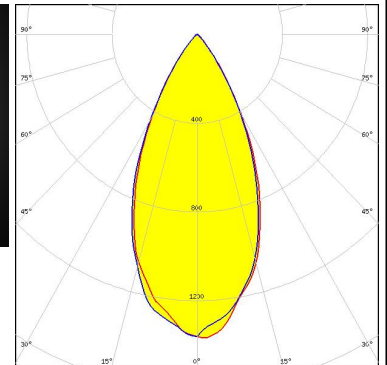
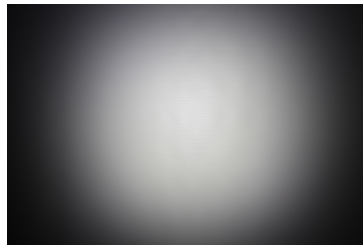

#### CREE → LED

LED XHP35 HI  
 FWHM / FWTM 44.0° / 72.0°  
 Efficiency 91 %  
 Peak intensity 1.4 cd/lm  
 LEDs/each optic 1  
 Light colour White  
 Required components:

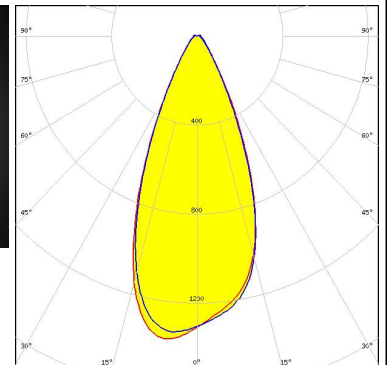
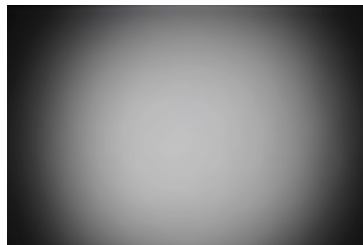

#### OPTICAL RESULTS (MEASURED):

##### CREE LED

LED XP-E  
 FWHM / FWTM 44.0° / 70.0°  
 Efficiency 81 %  
 Peak intensity 1.1 cd/m  
 LEDs/each optic 1  
 Light colour White  
 Required components:

##### CREE LED

LED XP-E2  
 FWHM / FWTM 45.0° / 72.0°  
 Efficiency 81 %  
 Peak intensity 1.4 cd/m  
 LEDs/each optic 1  
 Light colour White  
 Required components:

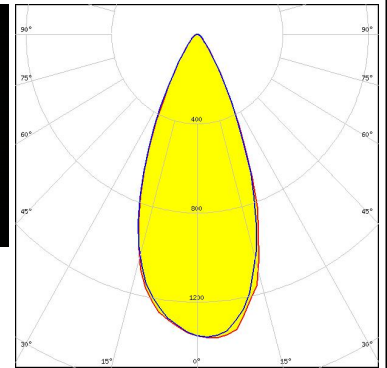
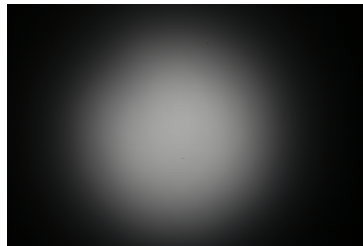

##### CREE LED





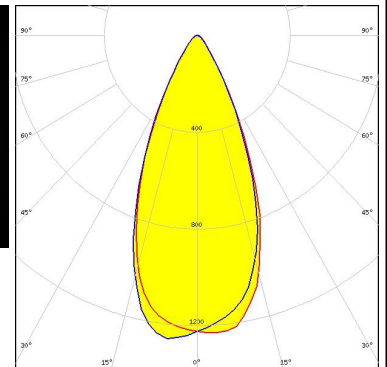
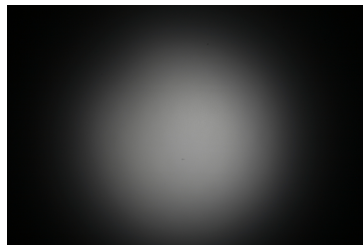

LED XP-G  
 FWHM / FWTM 44.0° / 72.0°  
 Efficiency 81 %  
 Peak intensity 1.1 cd/m  
 LEDs/each optic 1  
 Light colour White  
 Required components:

##### CREE LED

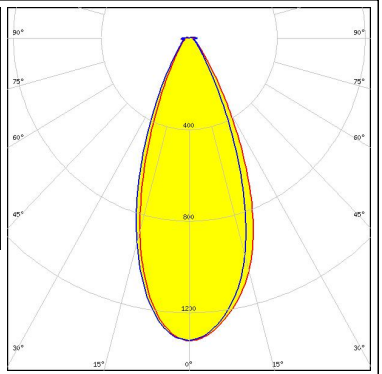

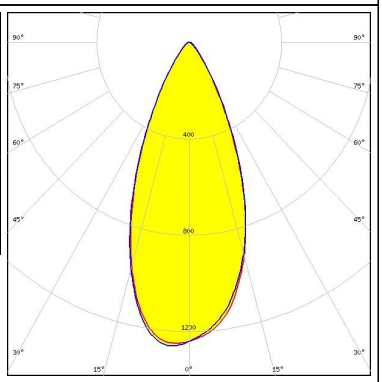

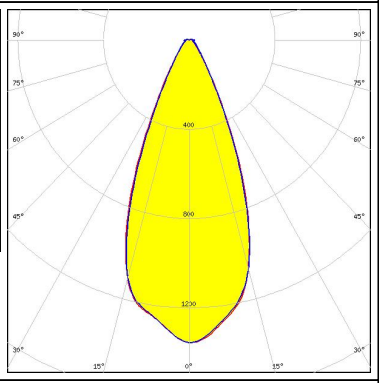

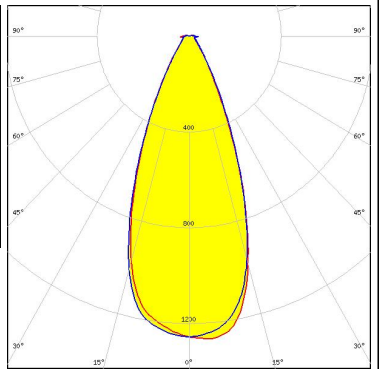
LED XP-G2  
 FWHM / FWTM 46.0° / 74.0°  
 Efficiency 80 %  
 Peak intensity 1.3 cd/m  
 LEDs/each optic 1  
 Light colour White  
 Required components:

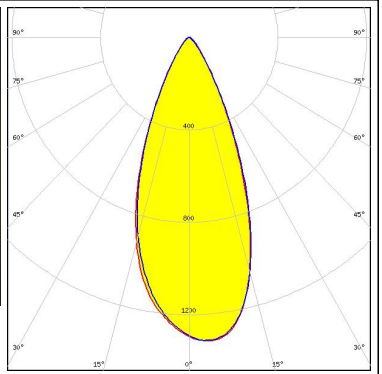

#### OPTICAL RESULTS (MEASURED):

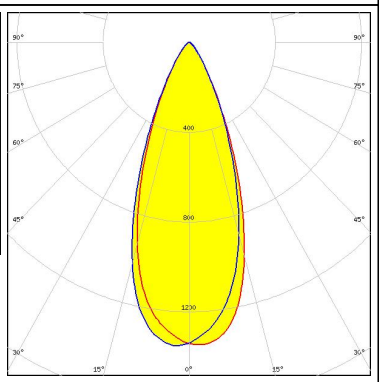
<p><b>CREE</b> ⇄ <b>LED</b></p> <p>LED            XP-G3            FWHM / FWTM    42.0° / 73.0°            Efficiency        91 %            Peak intensity    1.3 cd/lm            LEDs/each optic    1            Light colour        White            Required components:</p>		
<p><b>CREE</b> ⇄ <b>LED</b></p> <p>LED            XP-L HD            FWHM / FWTM    44.0° / 74.0°            Efficiency        79 %            Peak intensity    1.3 cd/lm            LEDs/each optic    1            Light colour        White            Required components:</p>		
<p><b>CREE</b> ⇄ <b>LED</b></p> <p>LED            XQ-E HD            FWHM / FWTM    44.0° / 70.0°            Efficiency        91 %            Peak intensity    1.4 cd/lm            LEDs/each optic    1            Light colour        White            Required components:</p>		
<p><b>CREE</b> ⇄ <b>LED</b></p> <p>LED            XQ-E HI            FWHM / FWTM    42.0° / 72.0°            Efficiency        87 %            Peak intensity    1.3 cd/lm            LEDs/each optic    1            Light colour        White            Required components:</p>		

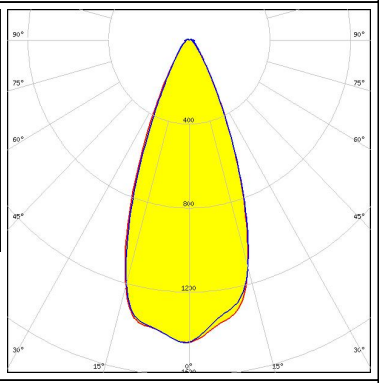
#### OPTICAL RESULTS (MEASURED):

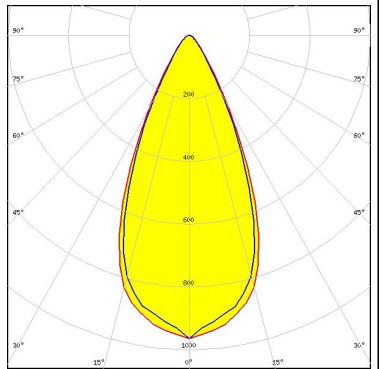
<p><b>CREE</b> LED</p> <p>LED XT-E            FWHM / FWTM 42.0° / 71.0°            Efficiency 75 %            Peak intensity 1.3 cd/m            LEDs/each optic 1            Light colour White            Required components:</p>		
<p><b>LUMILEDS</b></p> <p>LED LUXEON C            FWHM / FWTM 40.0° / 69.0°            Efficiency 71 %            Peak intensity 1.4 cd/m            LEDs/each optic 1            Light colour White            Required components:</p>		
<p><b>LUMILEDS</b></p> <p>LED LUXEON CZ            FWHM / FWTM 42.0° / 70.0°            Efficiency 93 %            Peak intensity 1.4 cd/m            LEDs/each optic 1            Light colour White            Required components:</p>		
<p><b>LUMILEDS</b></p> <p>LED LUXEON Rebel            FWHM / FWTM 49.0° / 76.0°            Efficiency 85 %            Peak intensity 1 cd/m            LEDs/each optic 1            Light colour White            Required components:</p>		

#### OPTICAL RESULTS (MEASURED):

##### LUMILEDS

LED LUXEON T  
 FWHM / FWTM 44.0° / 72.0°  
 Efficiency 83 %  
 Peak intensity 1.3 cd/m  
 LEDs/each optic 1  
 Light colour White  
 Required components:

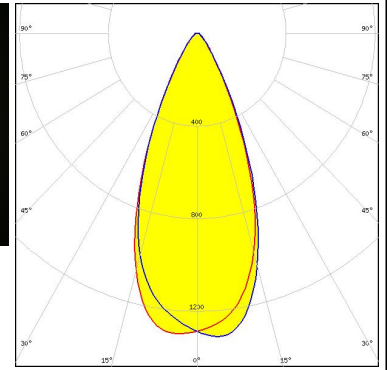
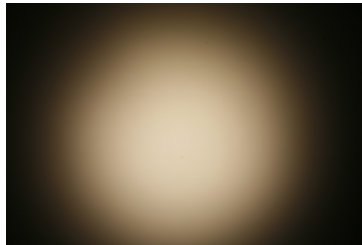

##### LUMILEDS

LED LUXEON TX  
 FWHM / FWTM 44.0° / 74.0°  
 Efficiency 78 %  
 Peak intensity 1.3 cd/m  
 LEDs/each optic 1  
 Light colour White  
 Required components:

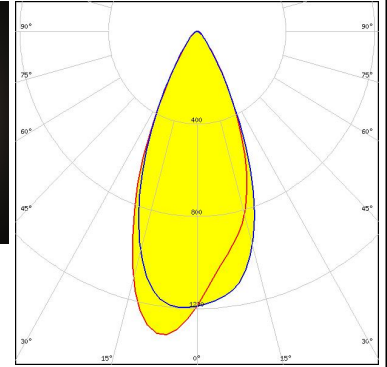

##### LUMINUS

LED SST-10-B130  
 FWHM / FWTM 43.0° / 72.0°  
 Efficiency 90 %  
 Peak intensity 1.4 cd/m  
 LEDs/each optic 1  
 Light colour Blue  
 Required components:

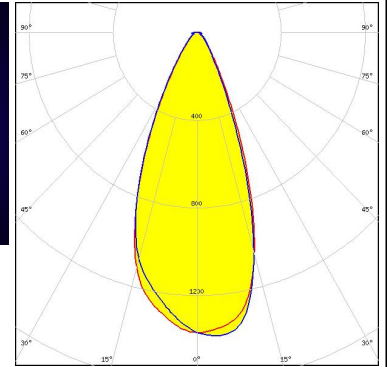
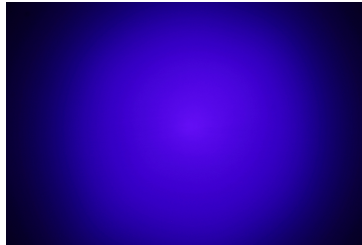





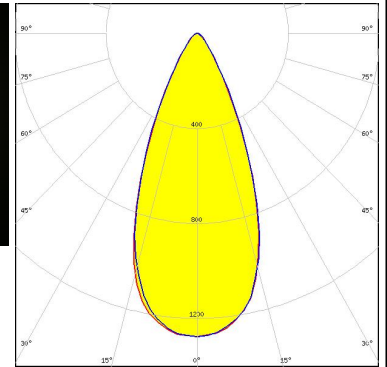
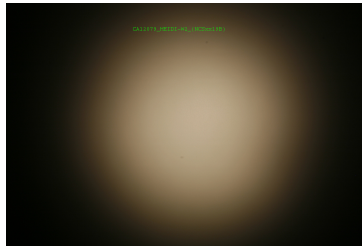

##### NICHIA

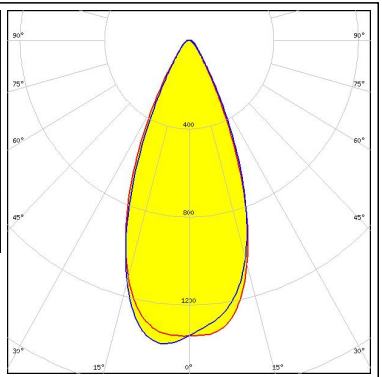
LED NCSxx19B  
 FWHM / FWTM 45.0° / 74.0°  
 Efficiency 78 %  
 Peak intensity 1.3 cd/m  
 LEDs/each optic 1  
 Light colour White  
 Required components:

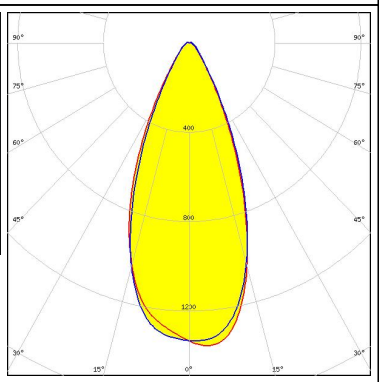

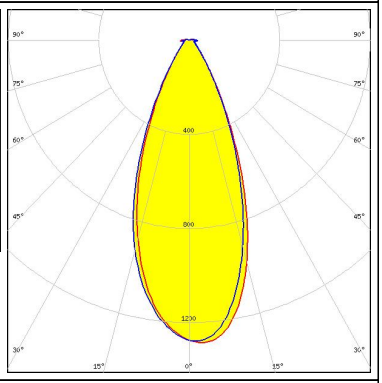
#### OPTICAL RESULTS (MEASURED):

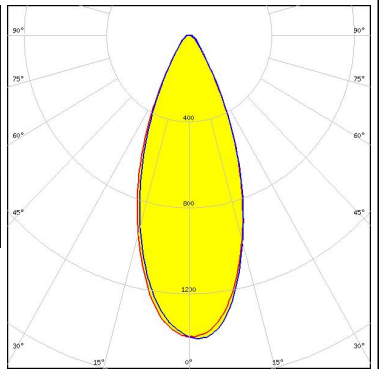
<p><b>NICHIA</b></p> <p>LED NVSW219D            FWHM / FWTM 45.0° / 72.0°            Efficiency 93 %            Peak intensity 1.4 cd/lm            LEDs/each optic 1            Light colour White            Required components:</p>		
<p><b>NICHIA</b></p> <p>LED NVSW319B            FWHM / FWTM 44.0° / 73.0°            Efficiency 91 %            Peak intensity 1.4 cd/lm            LEDs/each optic 1            Light colour White            Required components:</p>		
<p><b>NICHIA</b></p> <p>LED NVSW3x9A            FWHM / FWTM 42.0° / 75.0°            Efficiency 88 %            Peak intensity 1.3 cd/lm            LEDs/each optic 1            Light colour White            Required components:</p>		
<p><b>NICHIA</b></p> <p>LED NVSW519A            FWHM / FWTM 41.0° / 73.0°            Efficiency 91 %            Peak intensity 1.4 cd/lm            LEDs/each optic 1            Light colour White            Required components:</p>		



### OPTICAL RESULTS (MEASURED):



LED NVSxx19A  
 FWHM / FWTM 48.0° / 78.0°  
 Efficiency 79 %  
 Peak intensity 0.9 cd/lm  
 LEDs/each optic 1  
 Light colour White  
 Required components:



LED NVSxx19B/NVSxx19C  
 FWHM / FWTM 44.0° / 76.0°  
 Efficiency 77 %  
 Peak intensity 1.2 cd/lm  
 LEDs/each optic 1  
 Light colour White  
 Required components:

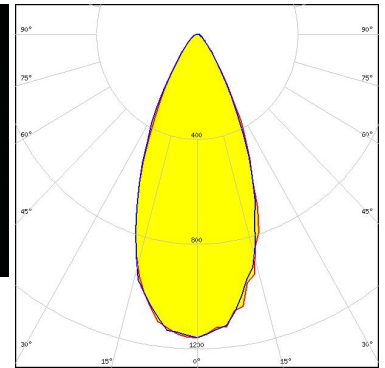

LED NVSxx19B/NVSxx19C  
 FWHM / FWTM 44.0 + 43.0° / 73.0°  
 Efficiency 91 %  
 Peak intensity 1.4 cd/lm  
 LEDs/each optic 1  
 Light colour White  
 Required components:

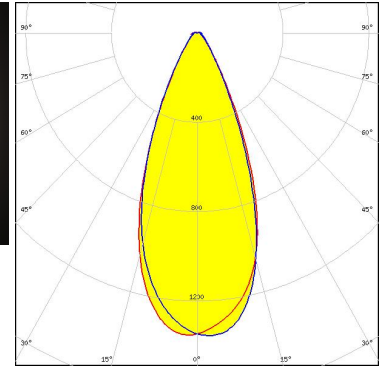
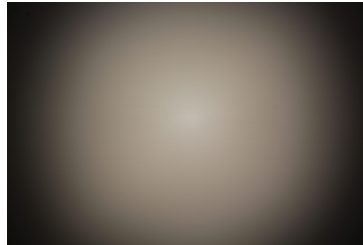

LED OSLON Square CSSRM2/CSSRM3  
 FWHM / FWTM 43.0° / 71.0°  
 Efficiency 91 %  
 Peak intensity 1.4 cd/lm  
 LEDs/each optic 1  
 Light colour White  
 Required components:

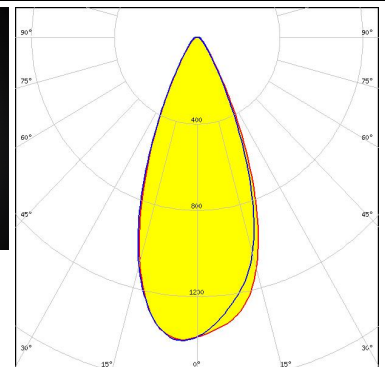
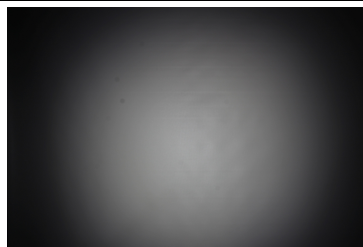

### OPTICAL RESULTS (MEASURED):

#### OSRAM

Opto Semiconductors

LED OSLON SSL 150  
FWHM / FWTM 40.0° / 67.0°  
Efficiency 81 %  
Peak intensity 1.2 cd/lm  
LEDs/each optic 1  
Light colour White  
Required components:

#### OSRAM

Opto Semiconductors

LED OSLON SSL 80  
FWHM / FWTM 47.0° / 76.0°  
Efficiency 80 %  
Peak intensity 1 cd/lm  
LEDs/each optic 1  
Light colour White  
Required components:

#### SAMSUNG

LED LH181A  
FWHM / FWTM 38.0° / 71.0°  
Efficiency 87 %  
Peak intensity 1.4 cd/lm  
LEDs/each optic 1  
Light colour White  
Required components:

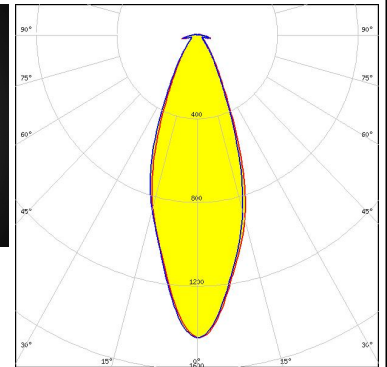
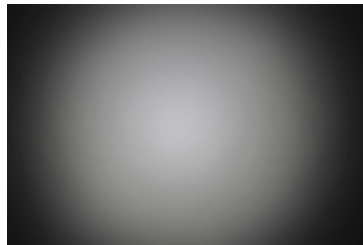

#### SAMSUNG

LED LH181B  
FWHM / FWTM 40.0° / 72.0°  
Efficiency 90 %  
Peak intensity 1.5 cd/lm  
LEDs/each optic 1  
Light colour White  
Required components:

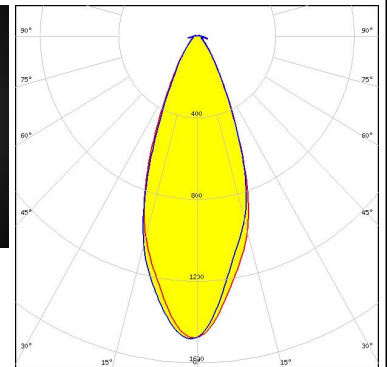
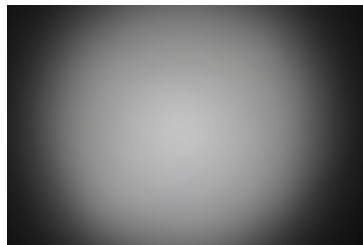

#### OPTICAL RESULTS (MEASURED):

### SAMSUNG

LED LH351Z  
 FWHM / FWTM 46.0° / 74.0°  
 Efficiency 82 %  
 Peak intensity 1.3 cd/m  
 LEDs/each optic 1  
 Light colour White  
 Required components:

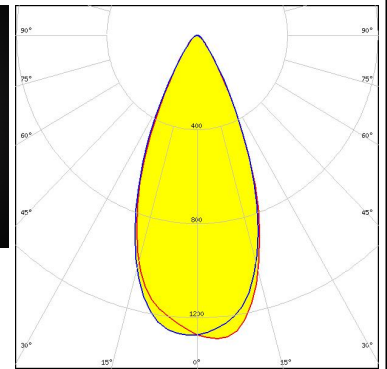
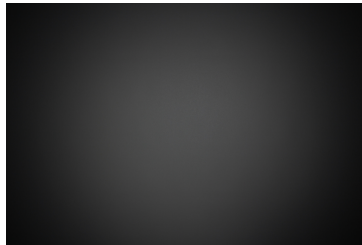

SEOUL SEMICONDUCTOR

LED Z5  
 FWHM / FWTM 44.0° / 73.0°  
 Efficiency 76 %  
 Peak intensity 1.2 cd/m  
 LEDs/each optic 1  
 Light colour White  
 Required components:



SEOUL SEMICONDUCTOR

LED Z5M1/Z5M2  
 FWHM / FWTM 44.0° / 73.0°  
 Efficiency 83 %  
 Peak intensity 1.3 cd/m  
 LEDs/each optic 1  
 Light colour White  
 Required components:

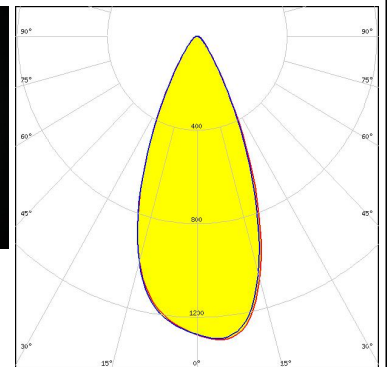
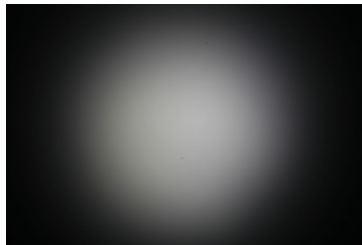

SEOUL SEMICONDUCTOR

LED Z8Y22P  
 FWHM / FWTM 43.0° / 77.0°  
 Efficiency 81 %  
 Peak intensity 1.1 cd/m  
 LEDs/each optic 1  
 Light colour White  
 Required components:

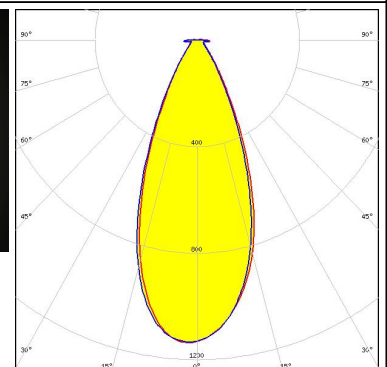
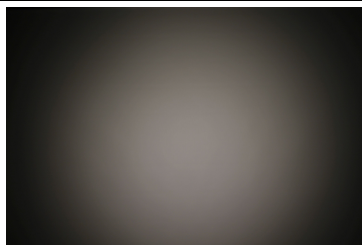

## OPTICAL RESULTS (MEASURED):

### SHARP

LED	Double Dome (GM2BB)
FWHM / FWTM	44.0°
Efficiency	%
LEDs/each optic	1
Light colour	White
Required components:	

### OPTICAL RESULTS (SIMULATED):

#### CREE LED

LED XP-G2 HE  
 FWHM / FWTM 45.0° / 70.0°  
 Efficiency 92 %  
 Peak intensity 1.6 cd/lm  
 LEDs/each optic 1  
 Light colour White  
 Required components:

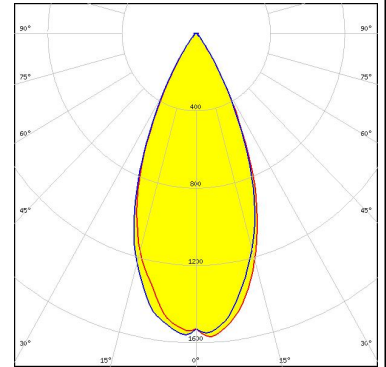

#### CREE LED

LED XP-L2  
 FWHM / FWTM 50.0° / 76.0°  
 Efficiency 93 %  
 Peak intensity 1.3 cd/lm  
 LEDs/each optic 1  
 Light colour White  
 Required components:

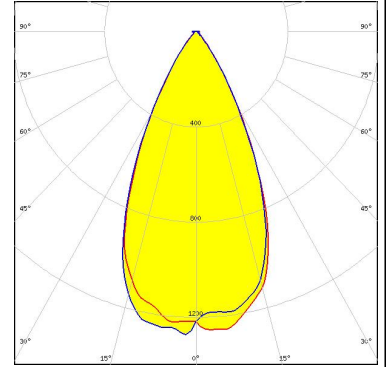

#### LUMILEDS

LED LUXEON 3030 HE Plus  
 FWHM / FWTM 48.0° / 68.0°  
 Efficiency 95 %  
 Peak intensity 1.5 cd/lm  
 LEDs/each optic 1  
 Light colour White  
 Required components:

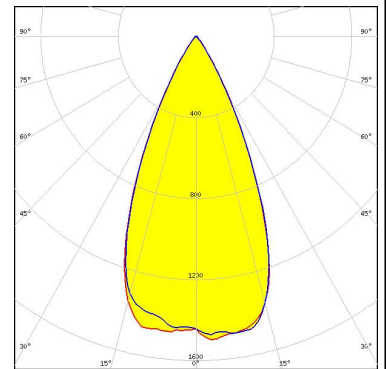

#### LUMILEDS

LED LUXEON 3030 HV  
 FWHM / FWTM 46.0° / 67.0°  
 Efficiency 93 %  
 Peak intensity 1.6 cd/lm  
 LEDs/each optic 1  
 Light colour White  
 Required components:

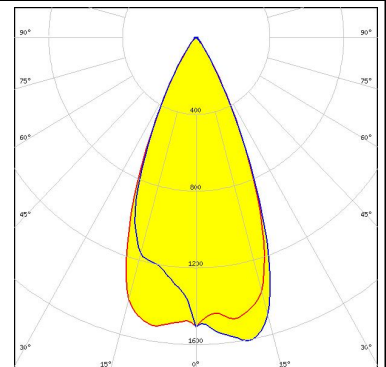

### OPTICAL RESULTS (SIMULATED):

#### LUMILEDS

LED LUXEON HL2X  
 FWHM / FWTM 47.0° / 68.0°  
 Efficiency 95 %  
 Peak intensity 1.6 cd/lm  
 LEDs/each optic 1  
 Light colour White  
 Required components:

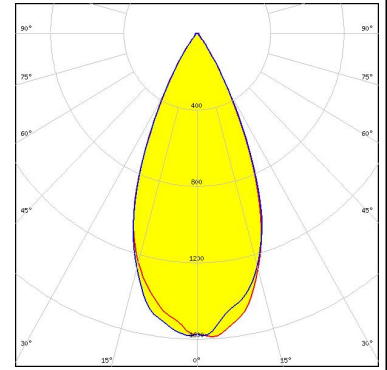

#### LUMILEDS

LED LUXEON HL2Z  
 FWHM / FWTM 46.0° / 70.0°  
 Efficiency 94 %  
 Peak intensity 1.5 cd/lm  
 LEDs/each optic 1  
 Light colour White  
 Required components:

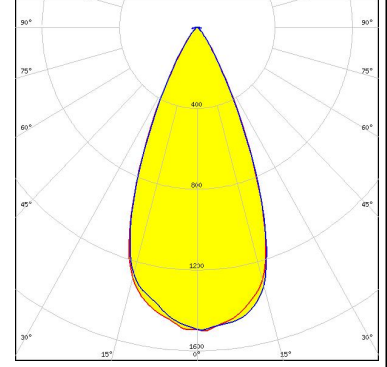

#### LUMILEDS

LED LUXEON SunPlus 20 Line (120 deg)  
 FWHM / FWTM 44.0° / 62.0°  
 Efficiency 95 %  
 Peak intensity 2 cd/lm  
 LEDs/each optic 1  
 Light colour White  
 Required components:

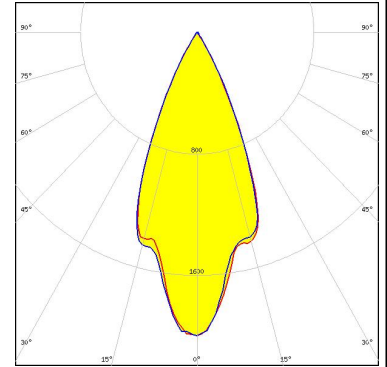

#### LUMILEDS

LED LUXEON SunPlus 20 Line (150 deg)  
 FWHM / FWTM 21.0° / 58.0°  
 Efficiency 88 %  
 Peak intensity 2.8 cd/lm  
 LEDs/each optic 1  
 Light colour White  
 Required components:

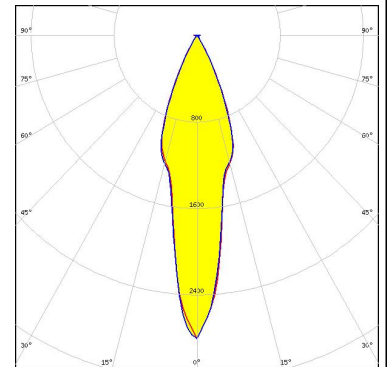

#### OPTICAL RESULTS (SIMULATED):

##### LUMILEDS

LED LUXEON Z  
 FWHM / FWTM 46.0° / 64.0°  
 Efficiency 95 %  
 Peak intensity 1.7 cd/lm  
 LEDs/each optic 1  
 Light colour White  
 Required components:

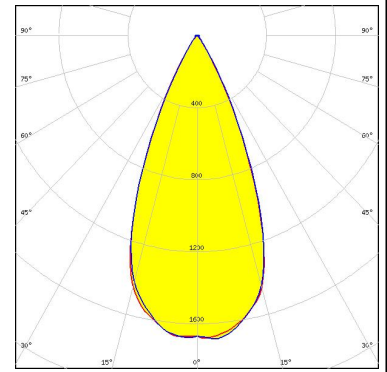

##### LUMILEDS

LED LUXEON Z ES  
 FWHM / FWTM 43.0° / 67.0°  
 Efficiency 94 %  
 Peak intensity 1.7 cd/lm  
 LEDs/each optic 1  
 Light colour White  
 Required components:

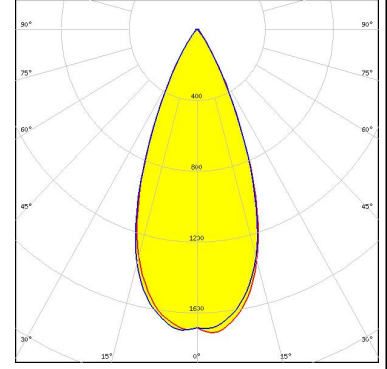

##### NICHIA

LED NCSxx19A  
 FWHM / FWTM 47.0° / 66.0°  
 Efficiency 92 %  
 Peak intensity 1.6 cd/lm  
 LEDs/each optic 1  
 Light colour White  
 Required components:

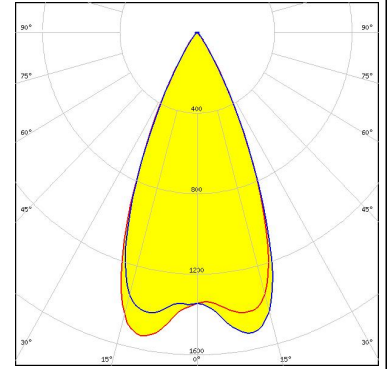

##### NICHIA

LED NV4WB35AM  
 FWHM / FWTM 48.0° / 72.0°  
 Efficiency 93 %  
 Peak intensity 1.5 cd/lm  
 LEDs/each optic 1  
 Light colour White  
 Required components:

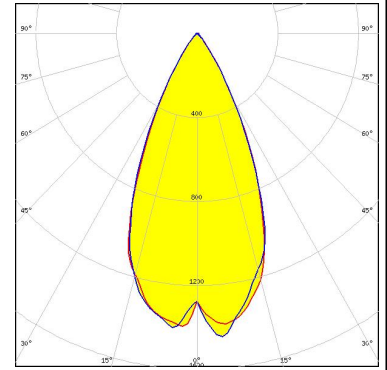

#### OPTICAL RESULTS (SIMULATED):

<p><b>NICHIA</b></p> <p>LED: NVSW219F            FWHM / FWTM: 46.0° / 70.0°            Efficiency: 93 %            Peak intensity: 1.6 cd/lm            LEDs/each optic: 1            Light colour: White            Required components:</p>	
<p><b>NICHIA</b></p> <p>LED: NVSxE21A            FWHM / FWTM: 46.0° / 72.0°            Efficiency: 92 %            Peak intensity: 1.4 cd/lm            LEDs/each optic: 1            Light colour: White            Required components:</p>	
<p><b>NICHIA</b></p> <p>LED: NVSxE21A            FWHM / FWTM: 46.0° / 70.0°            Efficiency: 93 %            Peak intensity: 1.5 cd/lm            LEDs/each optic: 1            Light colour: White            Required components:</p>	
<p><b>OSRAM</b>  <small>Opto Semiconductors</small></p> <p>LED: OSCONIQ P 3030            FWHM / FWTM: 46.0° / 68.0°            Efficiency: 93 %            Peak intensity: 1.6 cd/lm            LEDs/each optic: 1            Light colour: White            Required components:</p>	



### OPTICAL RESULTS (SIMULATED):

<b>OSRAM</b> <small>Opto Semiconductors</small>	<p>LED OSCONIQ P 3737 Flat</p> <p>FWHM / FWTM 47.0° / 70.0°</p> <p>Efficiency 96 %</p> <p>Peak intensity 1.5 cd/lm</p> <p>LEDs/each optic 1</p> <p>Light colour White</p> <p>Required components:</p>		
<b>OSRAM</b> <small>Opto Semiconductors</small>	<p>LED OSLON Square EC</p> <p>FWHM / FWTM 48.0° / 68.0°</p> <p>Efficiency 94 %</p> <p>Peak intensity 1.6 cd/lm</p> <p>LEDs/each optic 1</p> <p>Light colour White</p> <p>Required components:</p>		
<b>OSRAM</b> <small>Opto Semiconductors</small>	<p>LED SFH 4170S</p> <p>FWHM / FWTM 41.0° / 64.0°</p> <p>Efficiency 87 %</p> <p>LEDs/each optic 1</p> <p>Light colour IR</p> <p>Required components:</p>		
<b>OSRAM</b> <small>Opto Semiconductors</small>	<p>LED SFH 4716AS</p> <p>FWHM / FWTM 41.0° / 64.0°</p> <p>Efficiency 93 %</p> <p>LEDs/each optic 1</p> <p>Light colour IR</p> <p>Required components:</p>		

### OPTICAL RESULTS (SIMULATED):



### GENERAL INFORMATION:

NOTE: The typical beam angle will be changed by different color, chip size and chip position tolerance. The typical total beam angle is the full angle measured where the luminous intensity is half of the peak value.

### MATERIALS:

As part of our continuous research and improvement processes, and to ensure the best possible quality and availability of our products, LEDiL reserves the right to change material grades without notice.

### PRODUCT DATA USER AGREEMENT AND DISCLAIMER:

The measured data in the provided downloadable LEDiL Product Datasheets and Mechanical 2D-Drawings is rounded and provided as reference for planning. LEDiL Oy's optical specifications have been verified by conducting performance testing of the products in accordance with the company's quality system. The reported data are averaged results of multiple measurements with typical variation. LEDiL Oy reserves the right to without prior notification make changes and improvements to its products.

LEDiL Oy assumes neither warranty, nor guarantee nor any other liability of any kind for the contents and correctness of the provided data. The provided data has been generated with highest diligence but the provided data may in reality not represent the complete possible variation range of all intrinsic parameters. Therefore, in certain cases a deviation from the provided data could occur.

LEDiL Oy reserves the right to undertake technical changes of its products without further notification which could lead to changes in the provided data. LEDiL Oy assumes no liability of any kind for the possible deviation from any provided data or any other damage resulting from the usage of the provided data.

The user agrees to this disclaimer and user agreement with the download or usage of the provided files.

#### LEDiL Oy

Joensuunkatu 13  
FI-24240 SALO  
Finland

#### LEDiL Inc.

228 West Page Street  
Suite D  
Sycamore IL 60178  
USA

#### Ledil Optics Technology (Shenzhen) Co., Ltd.

# 405 , Block B  
Casic Motor Building  
Shenzhen 518057  
P.R.CHINA

#### Local sales and technical support

[www.ledil.com/  
where\\_to\\_buy](http://www.ledil.com/where_to_buy)

#### Shipping locations

Salo, Finland  
Hong Kong, China

#### Distribution Partners

[www.ledil.com/  
where\\_to\\_buy](http://www.ledil.com/where_to_buy)