

ST3045C/STB3045C/STD3045C SCHOTTKY RECTIFIER

Applications

- Switching power supply
- Converters
- Free-Wheeling diodes
- Reverse battery protection

Features

- 150 °C T_J operation
- Center tap configuration
- Ultralow forward voltage drop
- High purity, high temperature epoxy encapsulation for enhanced mechanical strength and moisture resistance
- High frequency operation
- Guard ring for enhanced ruggedness and long term reliability
- Trench MOS Schottky technology
- This is a Pb – Free Device
- All SMC parts are traceable to the wafer lot
- Additional testing can be offered upon request

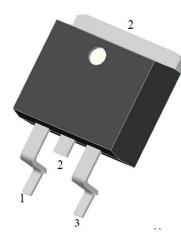
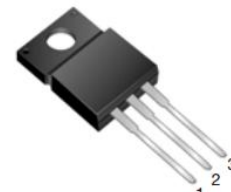
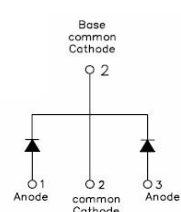
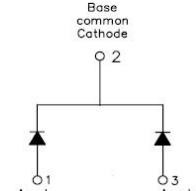
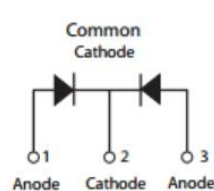
ST3045C	STB3045C	STF3045C
		
		
TO-220AB	D ² PAK	ITO-220AB

Maximum Ratings:

Characteristics	Symbol	Condition	Max.	Units
Peak Repetitive Reverse Voltage	V _{RRM}	-	45	V
Working Peak Reverse Voltage	V _{RWM}			
DC Blocking Voltage	V _R			
Average Rectified Forward Current	I _{F(AV)}	50% duty cycle @T _c =135°C, rectangular wave form	15(Per Leg) 30(Per Device)	A
Peak One Cycle Non-Repetitive Surge Current(Per Leg)	I _{FSM}	8.3ms, Half Sine pulse	200	A

Electrical Characteristics:

Characteristics	Symbol	Condition	Typ.	Max.	Units
Forward Voltage Drop(Per Leg)*	V _{F1}	@ 5A, Pulse, T _J = 25°C	0.41	-	V
		@ 7.5A, Pulse, T _J = 25°C	0.44	-	
@ 15A, Pulse, T _J = 25°C		0.50	0.57		
	V _{F2}	@ 5A, Pulse, T _J = 125°C	0.31	-	V
		@ 7.5A, Pulse, T _J = 125°C	0.35	-	
		@ 15A, Pulse, T _J = 125°C	0.45	0.48	
Reverse Current(Per Leg)*	I _{R1}	@V _R = rated V _R T _J = 25°C	0.028	2.0	mA
	I _{R2}	@V _R = rated V _R T _J = 125°C	14	150	mA
Junction Capacitance	C _T	@V _R = 5V, T _C = 25 °C f _{SIG} = 1MHz	840	-	pF

* Pulse width < 300 μs, duty cycle < 2%

Thermal-Mechanical Specifications:

Characteristics	Symbol	ST3045C	STB3045C	STF3045C	Units
Junction Temperature	T _J	-55 to +150			°C
Storage Temperature	T _{stg}	-55 to +150			°C
Typical Thermal Resistance Junction to Case(Per Leg)	R _{θJC}	1.6	1.6	5	°C/W

Tube Specification

Device	Package	Weight	Shipping
ST3045C	TO-220AB	2.0	50pcs / tube
STB3045C	D ² PAK	1.85	800pcs / reel
STF3045C	ITO-220AB	2.0	50pcs / tube

For information on tape and reel specifications, including part orientation and tape sizes, please refer to our tape and reel packaging specification.

Tube Specification(TO-220AB/ITO-220AB)

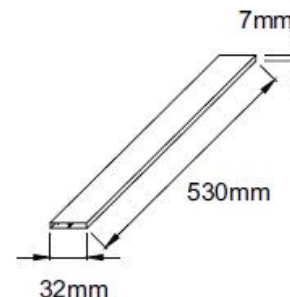

Ratings and Characteristics Curves

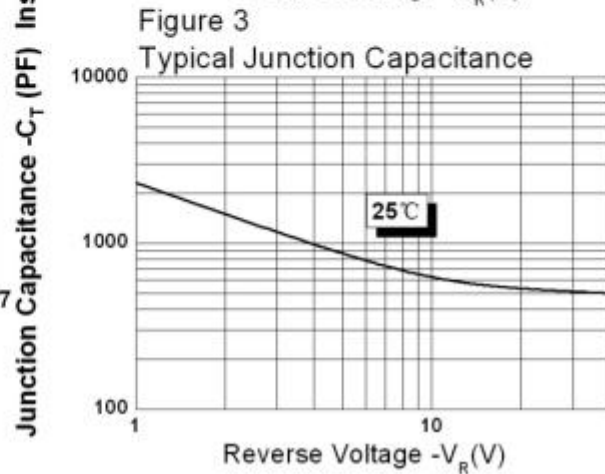
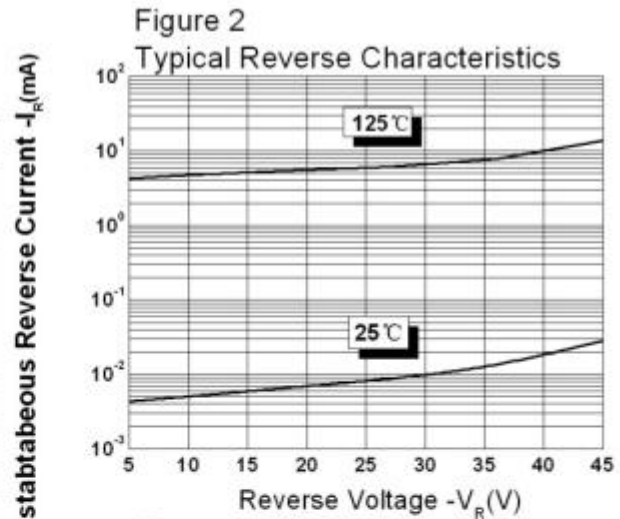
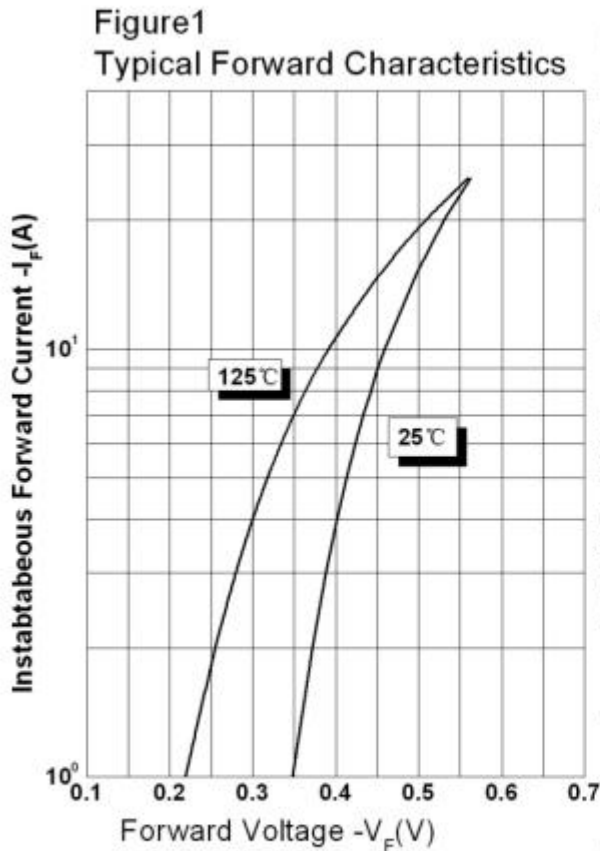

Marking Diagram

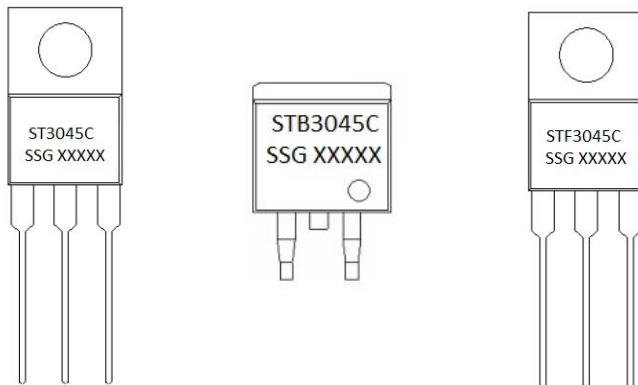

Where XXXXX is YYWWL

ST = Device Type
B/F = Package type
30 = Forward Current (30A)
45 = Reverse Voltage (45V)
C = Configuration
SSG = SSG
YY = Year
WW = Week
L = Lot Number

Cautions: Molding resin
Epoxy resin UL:94V-0

Carrier Tape Specification D2PAK

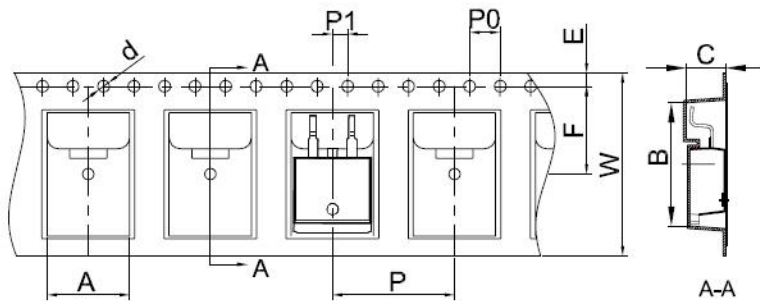

SYMBOL	Millimeters	
	Min.	Max.
A	10.70	10.90
B	16.03	16.23
C	5.11	5.31
d	1.45	1.65
E	1.65	1.85
F	11.40	11.60
P0	3.90	4.10
P	15.90	16.10
P1	1.90	2.10
W	23.90	24.30

Mechanical Dimensions TO-220AB

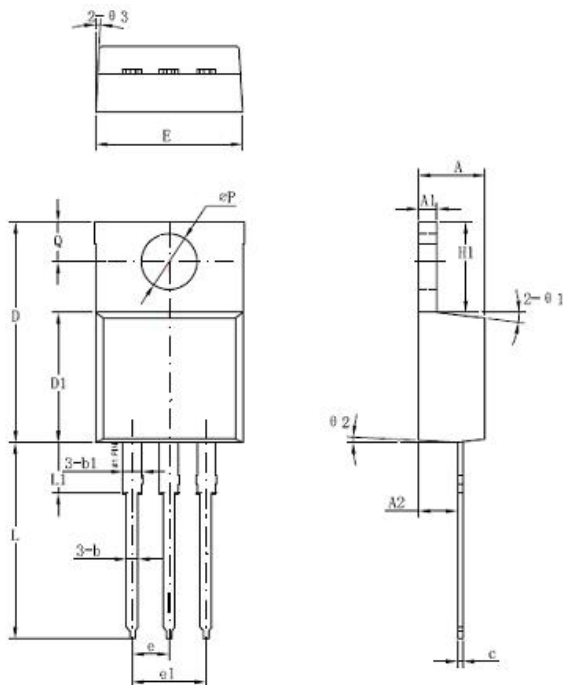

Symbol	Dimensions in millimeters		
	Min	Typical	Max
A	4.42	4.57	4.72
A1	1.17	1.27	1.37
A2	2.52	2.69	2.89
b	0.71	0.81	0.96
b1	1.17	1.27	1.37
c	0.31	0.38	0.61
D	14.94	15.24	15.54
D1	8.85	9.00	9.15
E	10.01	10.16	10.31
e		2.54	
e1	4.98	5.06	5.18
H1	6.04	6.24	6.44
L	12.7	13.56	13.80
L1	3.56	3.5	3.96
ΦP	3.74	3.84	4.04
Q	2.54	2.74	2.94
$\theta 1$		7°	
$\theta 2$		3°	
$\theta 3$		4°	

Mechanical Dimensions D²PAK

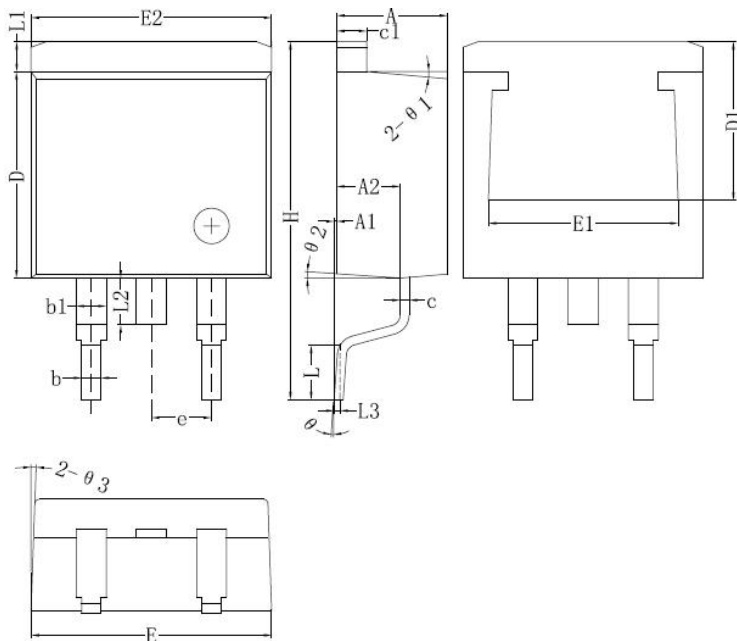

Symbol	Dimensions in millimeters		
	Min.	Typical	Max.
A	4.55	4.70	4.85
A1	0	0.10	0.25
A2	2.59	2.69	2.89
b	0.71	0.81	0.96
b1		1.27	
c	0.36	0.38	0.61
D	8.55	8.70	8.85
D1	6.40		
E	10.01	10.16	10.31
E1	7.6		
E2	9.98	10.08	10.18
e		2.54	
H	14.6	15.1	15.6
L	2.00	2.30	2.70
L1	1.17	1.27	1.40
L2			2.20
L3		0.25BSC	
e	0	-	8°
e1		5°	
e2		4°	
e3		4°	

Mechanical Dimensions ITO-220AB

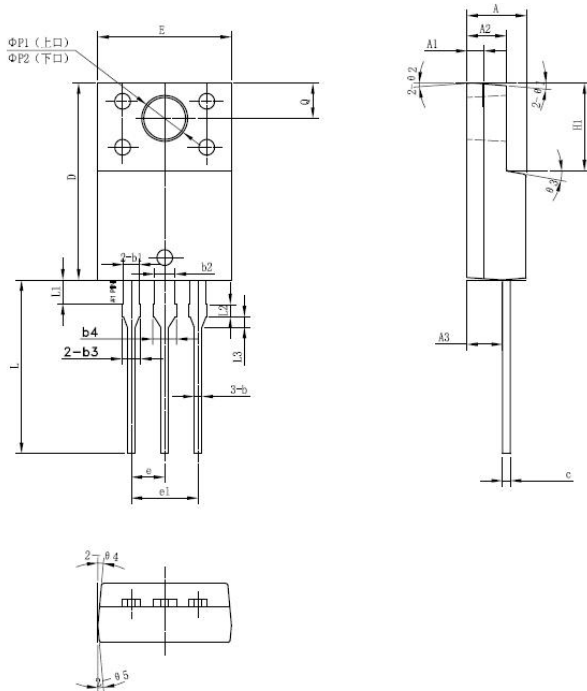

Symbol	Dimensions in millimeters		
	Min.	Typical	Max.
A	4.30	4.50	4.70
A1	1.10	1.30	1.50
A2	2.80	3.00	3.20
A3	2.50	2.70	2.90
b	0.50	0.60	0.75
b1	1.10	1.20	1.35
b2	1.50	1.60	1.75
b3	1.20	1.30	1.45
b4	1.60	1.70	1.85
c	0.50	0.60	0.75
D	14.80	15.00	15.20
E	9.96	10.16	10.36
e		2.55	
e1		5.10	
H1	6.50	6.70	6.90
L	12.70	13.20	13.70
L1	1.60	1.80	2.00
L2	0.80	1.00	1.20
L3	0.60	0.80	1.00
ΦP1(上口)	3.30	3.50	3.70
ΦP2(下口)	2.99	3.19	3.39
Q	2.50	2.70	2.90
θ1		5°	
θ2		4°	
θ3		10°	
θ4		5°	
θ5		5°	

DISCLAIMER:

1- The information given herein, including the specifications and dimensions, is subject to change without prior notice to improve product characteristics. Before ordering, purchasers are advised to contact the SMC - Sangdest Microelectronics (Nanjing) Co., Ltd sales department for the latest version of the datasheet(s).

2- In cases where extremely high reliability is required (such as use in nuclear power control, aerospace and aviation, traffic equipment, medical equipment, and safety equipment), safety should be ensured by using semiconductor devices that feature assured safety or by means of users' fail-safe precautions or other arrangement.

3- In no event shall SMC - Sangdest Microelectronics (Nanjing) Co., Ltd be liable for any damages that may result from an accident or any other cause during operation of the user's units according to the datasheet(s). SMC - Sangdest Microelectronics (Nanjing) Co., Ltd assumes no responsibility for any intellectual property claims or any other problems that may result from applications of information, products or circuits described in the datasheets.

4- In no event shall SMC - Sangdest Microelectronics (Nanjing) Co., Ltd be liable for any failure in a semiconductor device or any secondary damage resulting from use at a value exceeding the absolute maximum rating.

5- No license is granted by the datasheet(s) under any patents or other rights of any third party or SMC - Sangdest Microelectronics (Nanjing) Co., Ltd.

6- The datasheet(s) may not be reproduced or duplicated, in any form, in whole or part, without the expressed written permission of SMC - Sangdest Microelectronics (Nanjing) Co., Ltd.

7- The products (technologies) described in the datasheet(s) are not to be provided to any party whose purpose in their application will hinder maintenance of international peace and safety nor are they to be applied to that purpose by their direct purchasers or any third party. When exporting these products (technologies), the necessary procedures are to be taken in accordance with related laws and regulations..